

US00D641889S

(12) **United States Design Patent**
Larsen et al.

(10) **Patent No.:** **US D641,889 S**
(45) **Date of Patent:** **** Jul. 19, 2011**

- (54) **SPA SHELL**
- (75) Inventors: **Christopher Carl Larsen**, Vista, CA (US); **Sage Nathan Baker**, Cardiff, CA (US)
- (73) Assignee: **Watkins Manufacturing Corporation**, Vista, CA (US)
- (**) Term: **14 Years**
- (21) Appl. No.: **29/382,882**
- (22) Filed: **Jan. 10, 2011**
- (51) **LOC (9) Cl.** **23-02**
- (52) **U.S. Cl.** **D24/204**
- (58) **Field of Classification Search** D24/201, D24/204, 205; D23/277, 278, 276, 280.1-280.3; 601/154-158; 4/541.1-541.6, 547, 578.1, 4/579

See application file for complete search history.

(56) **References Cited**

U.S. PATENT DOCUMENTS

D288,125 S	2/1987	Watkins
D367,708 S	3/1996	Lawing et al.
D368,530 S	4/1996	Lawing et al.
D387,869 S	12/1997	Larsen
D387,870 S	12/1997	Larsen
D405,181 S	2/1999	Larsen
D405,182 S	2/1999	Larsen
D405,185 S	2/1999	Larsen
D405,186 S	2/1999	Larsen
D431,297 S	9/2000	Larsen et al.
D436,178 S	1/2001	Larsen et al.
D445,904 S	7/2001	Larsen
D446,309 S	8/2001	Bower
D446,310 S	8/2001	Bower
D446,862 S	8/2001	Larsen et al.
D463,028 S	9/2002	Bower
D463,569 S	9/2002	Bower
D465,576 S	11/2002	Larsen

D496,107 S	9/2004	Larsen	
D517,697 S	3/2006	Larsen	
D527,828 S	9/2006	Larsen	
D528,661 S *	9/2006	Loyd	D24/204
D528,663 S *	9/2006	Loyd	D24/204
D529,181 S *	9/2006	Loyd	D24/204
D531,731 S	11/2006	Larsen	
D542,416 S	5/2007	Larsen	
D542,925 S	5/2007	Larsen	
D543,282 S	5/2007	Larsen	
D543,283 S	5/2007	Larsen	
D550,371 S	9/2007	Larsen	
D551,356 S *	9/2007	Loyd	D24/204
D551,357 S *	9/2007	Loyd	D24/204
D552,746 S *	10/2007	Loyd	D24/204
D565,190 S *	3/2008	Lenci	D24/204
D589,624 S	3/2009	Larsen	

(Continued)

Primary Examiner — David Muller

(74) *Attorney, Agent, or Firm* — Nirav D. Parikh; Lora J. Graentzdoerffer; Edgar A. Zarins

(57) **CLAIM**

The ornamental design for a spa shell, as shown and described.

DESCRIPTION

FIG. 1 is a perspective view of a spa shell showing our design; FIG. 2 is a perspective view thereof; FIG. 3 is a top plan view thereof; FIG. 4 is a cross-sectional view taken along 4-4 of FIG. 3; FIG. 5 is a cross-sectional view taken along 5-5 of FIG. 3; FIG. 6 is a cross-sectional view taken along 6-6 of FIG. 3; FIG. 7 is a cross-sectional view taken along 7-7 of FIG. 3; FIG. 8 is a cross-sectional view taken along 8-8 of FIG. 3; and, FIG. 9 is a cross-sectional view taken along 9-9 of FIG. 3. The broken-line disclosure in the views represents portions of the article in which the claimed design is embodied, but which form no part of the claimed design.

1 Claim, 6 Drawing Sheets

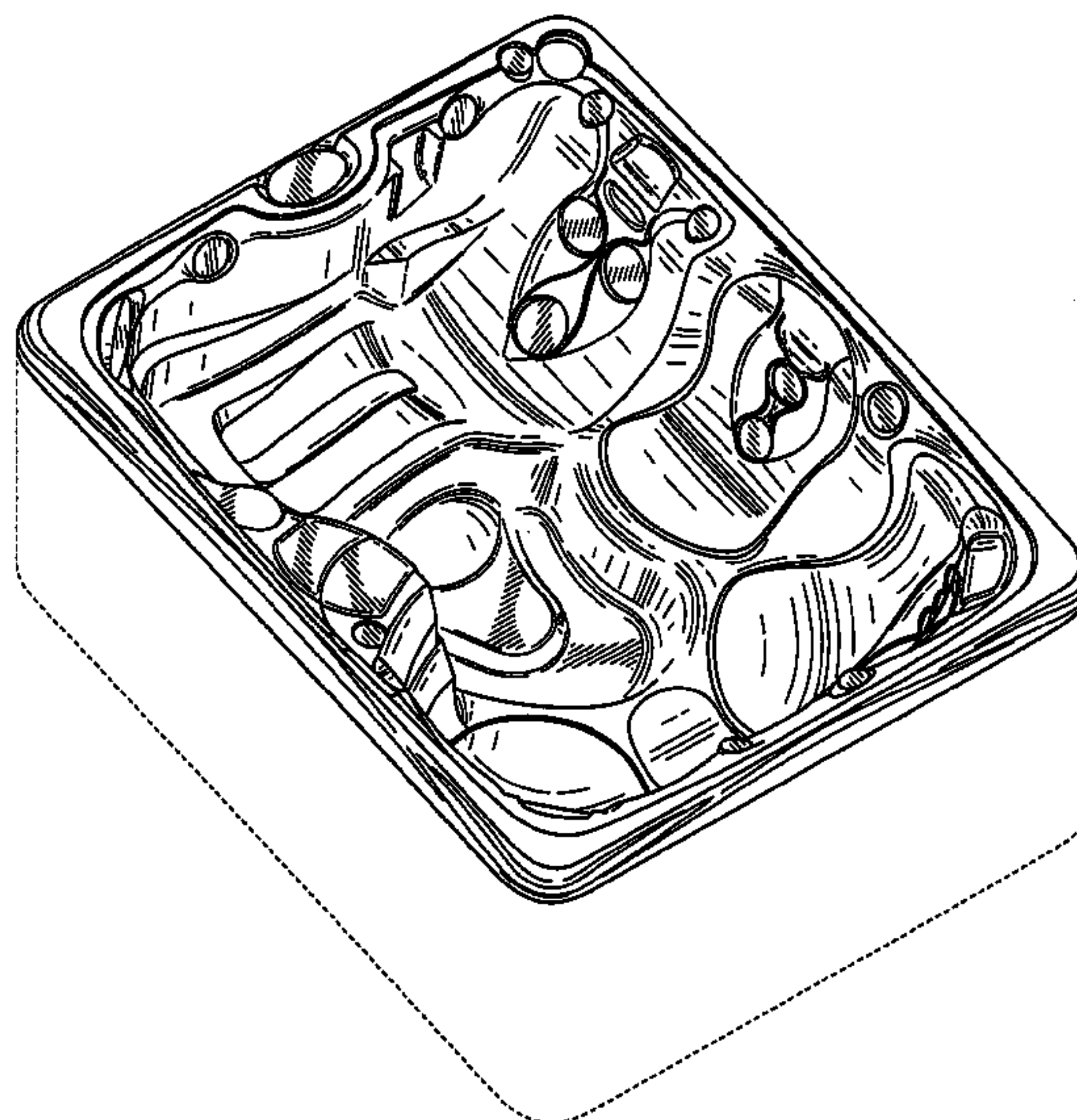

US D641,889 S

Page 2

U.S. PATENT DOCUMENTS

D590,951 S	4/2009	Larsen	
D592,736 S *	5/2009	Cunningham D23/277
D592,737 S *	5/2009	Cunningham D23/277
D600,816 S	9/2009	Larsen	
D601,263 S	9/2009	Larsen	
D611,612 S	3/2010	Nering	
D614,776 S *	4/2010	Loyd D24/204
D616,104 S	5/2010	Larsen et al.	
D616,105 S	5/2010	Larsen et al.	
D616,106 S	5/2010	Larsen et al.	
D616,999 S	6/2010	Larsen et al.	
D620,599 S	7/2010	Larsen et al.	
D620,600 S	7/2010	Larsen et al.	
D621,946 S	8/2010	Larsen et al.	
D621,947 S	8/2010	Larsen et al.	
D624,657 S	9/2010	Larsen et al.	
D628,302 S	11/2010	Larsen et al.	
D634,019 S *	3/2011	Larsen et al. D24/204
D634,020 S *	3/2011	Larsen et al. D24/204
D634,021 S *	3/2011	Larsen et al. D24/204

* cited by examiner

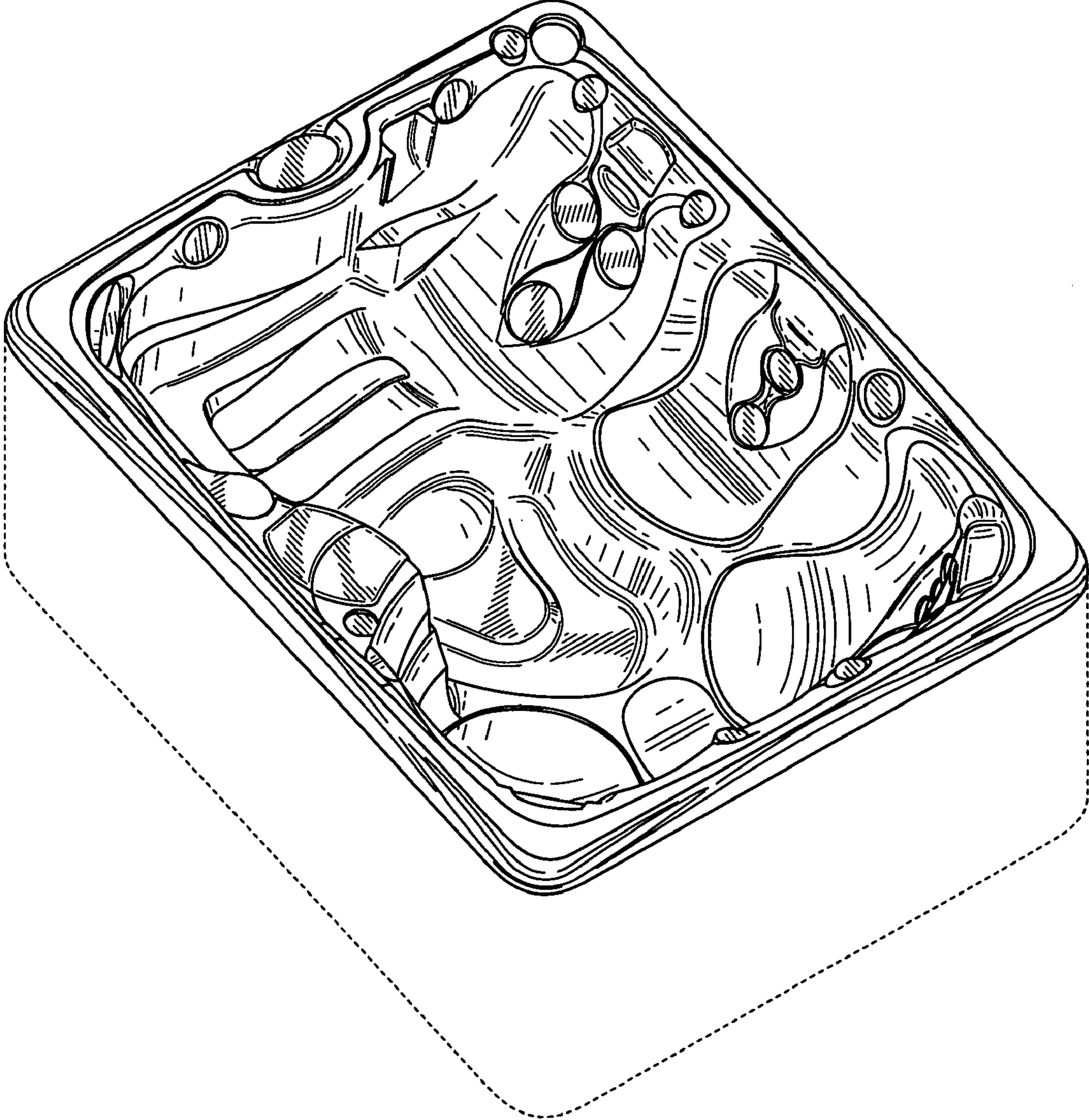

FIG. 1

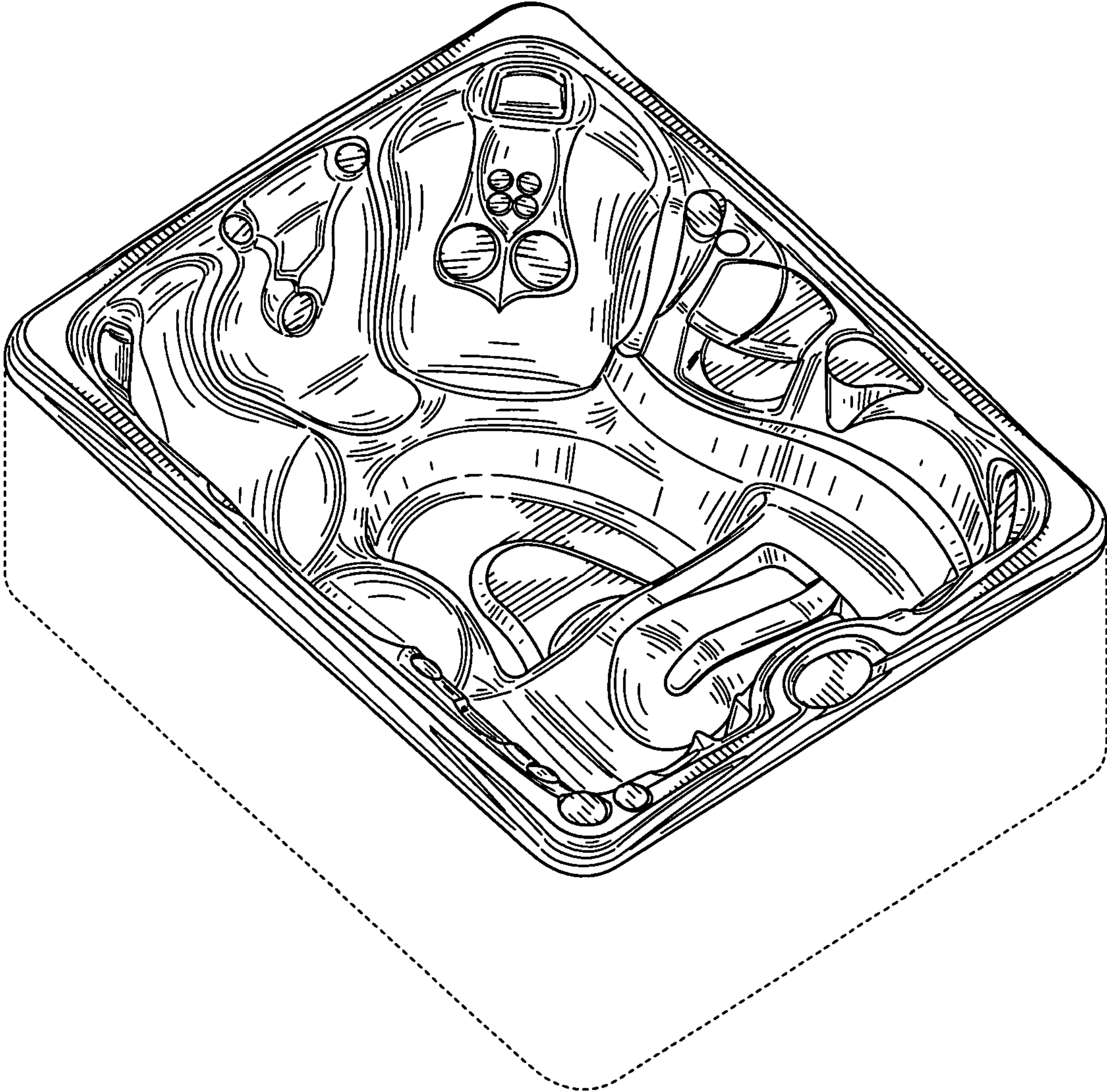

FIG. 2

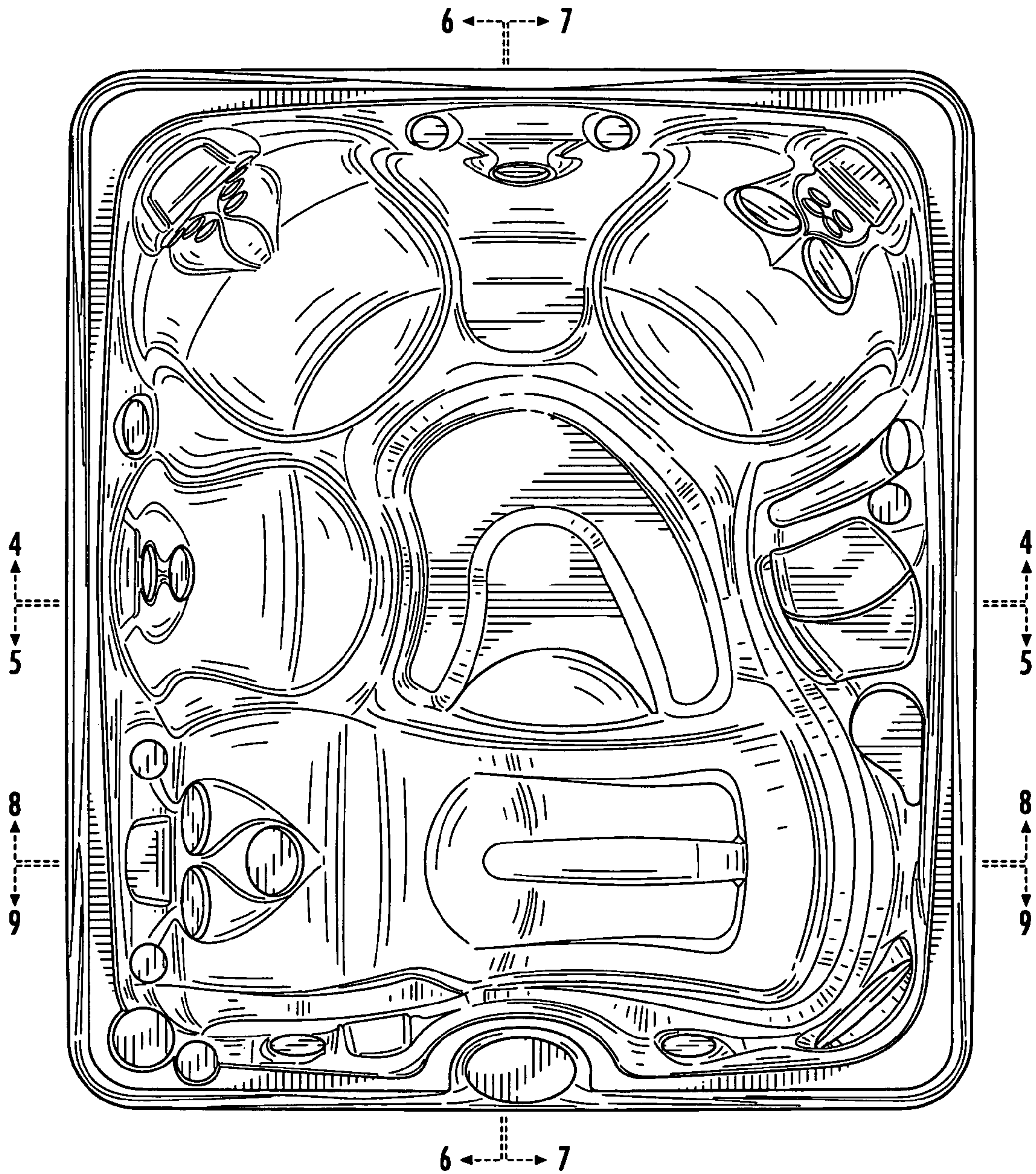

FIG. 3

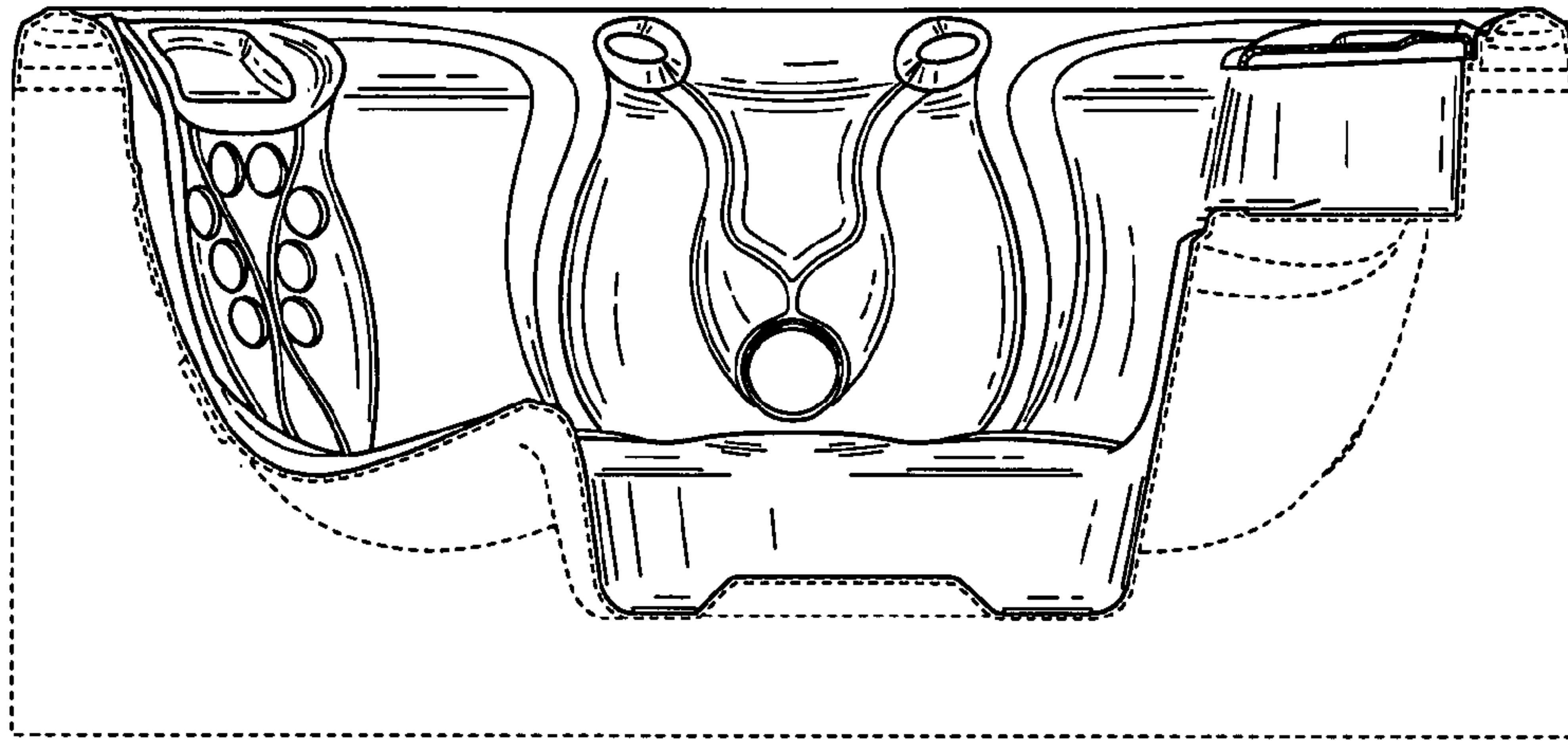

FIG. 4

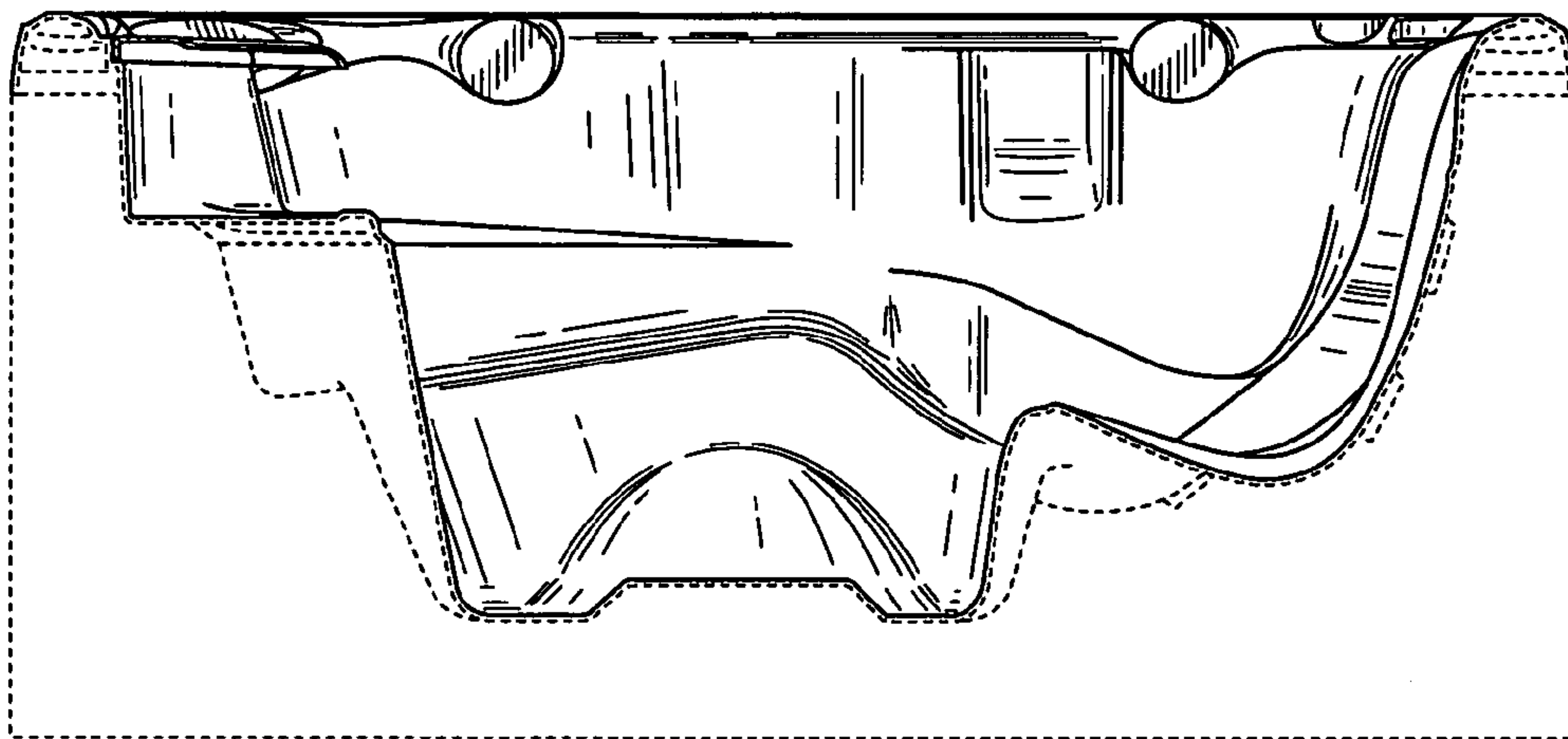

FIG. 5

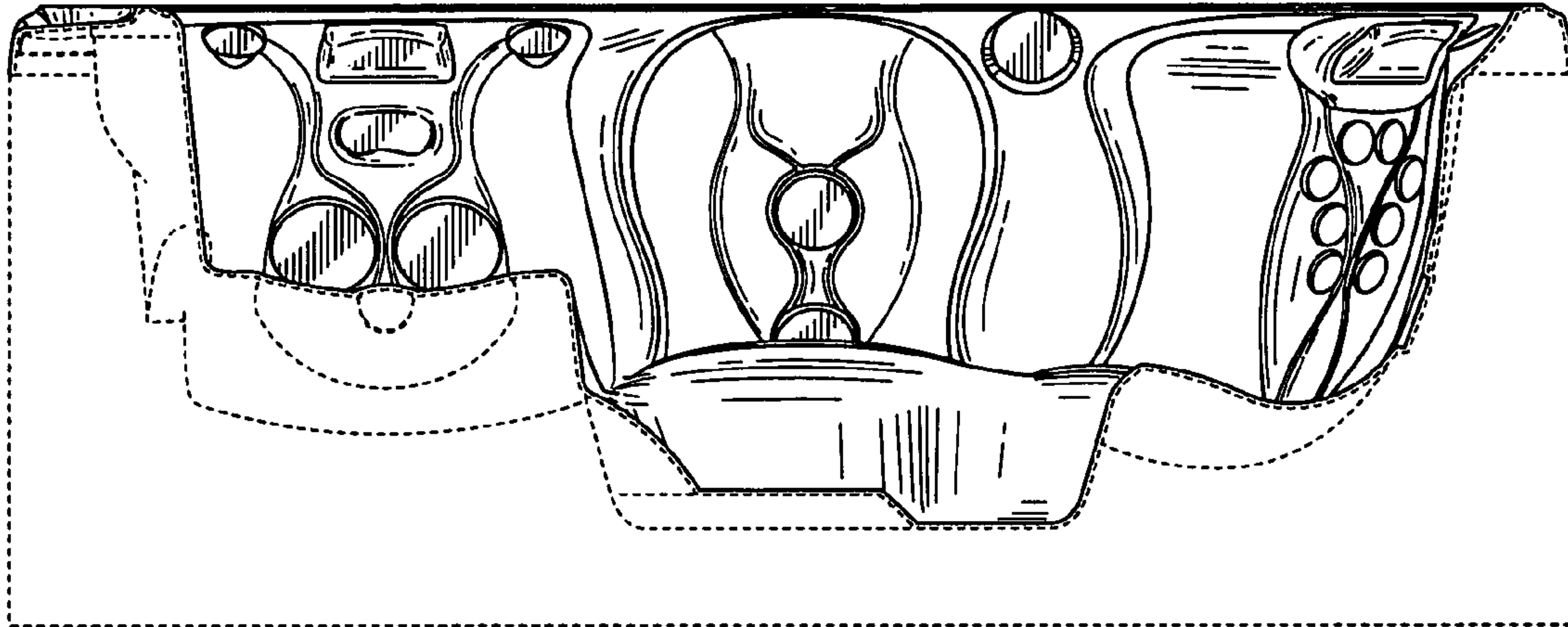

FIG. 6

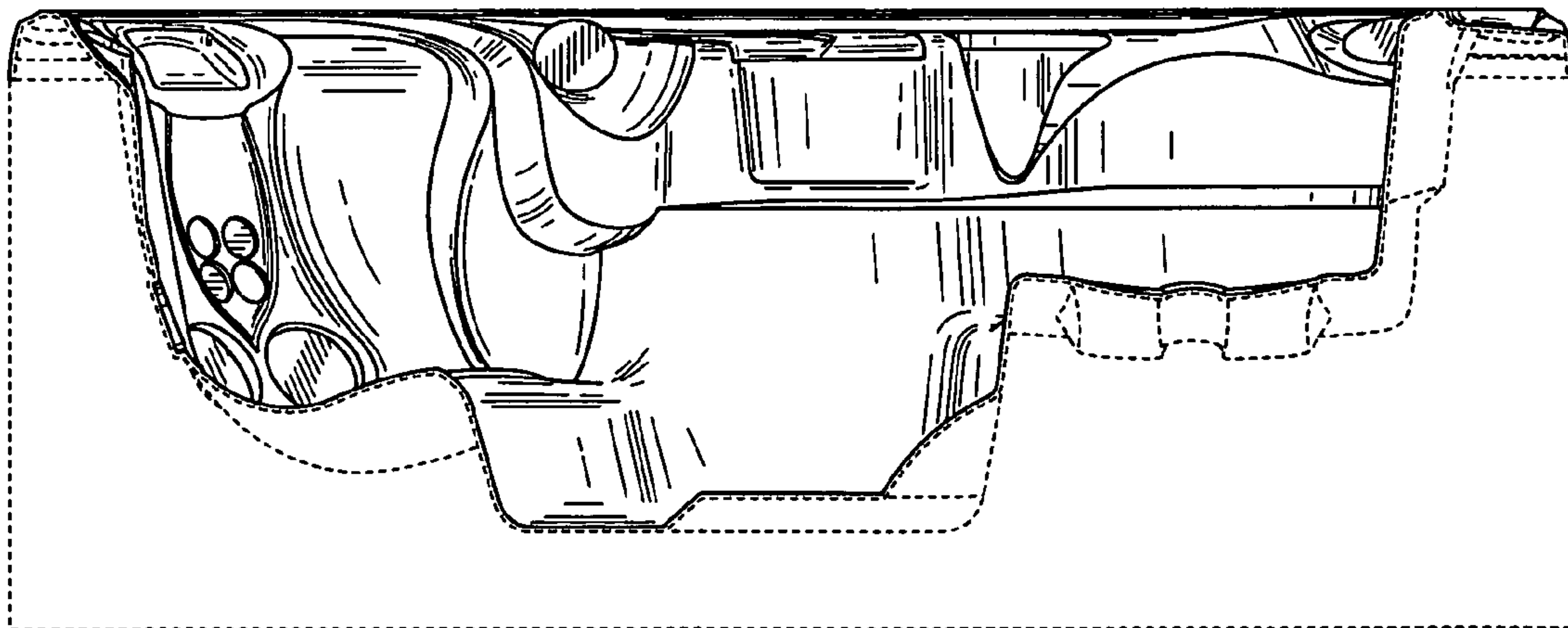

FIG. 7

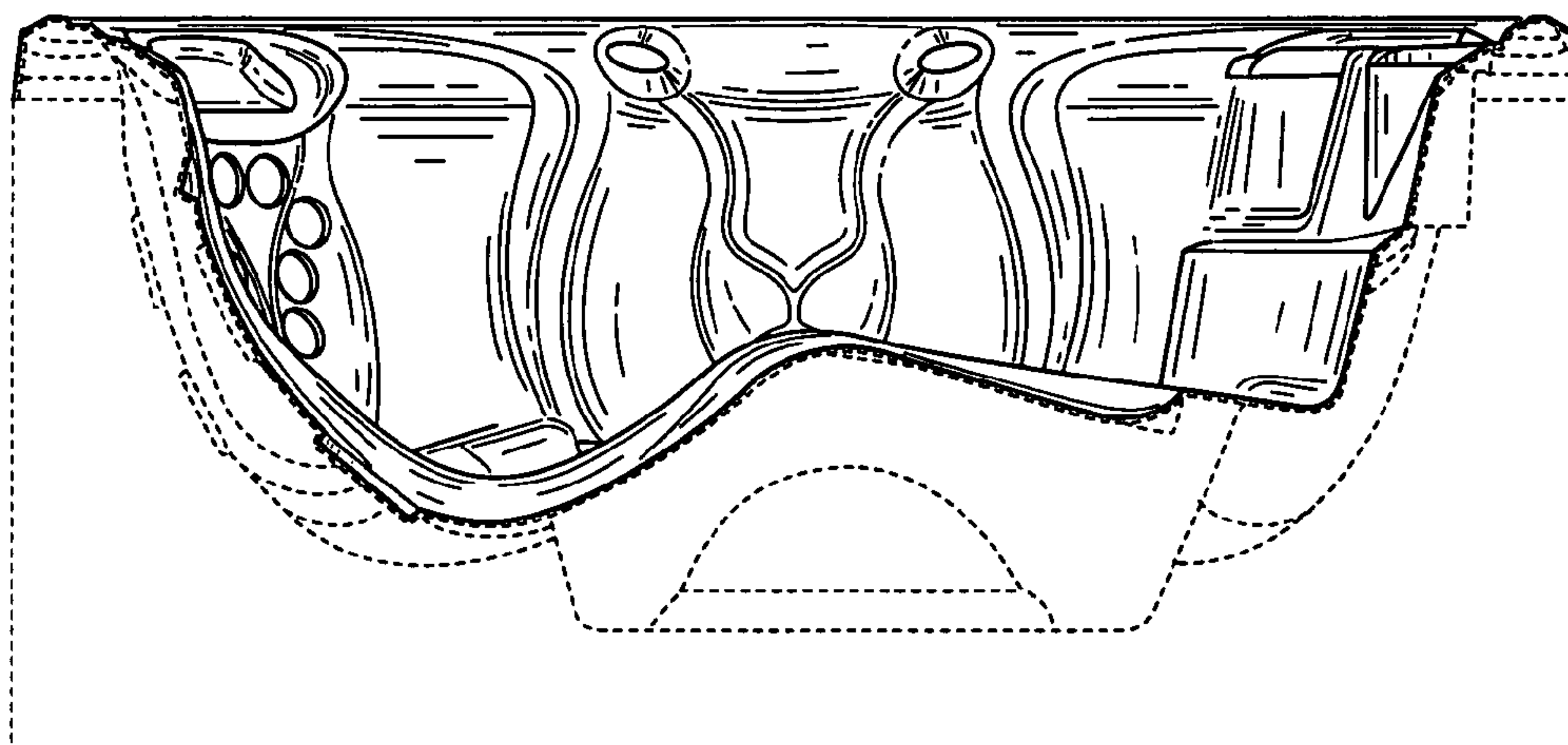

FIG. 8

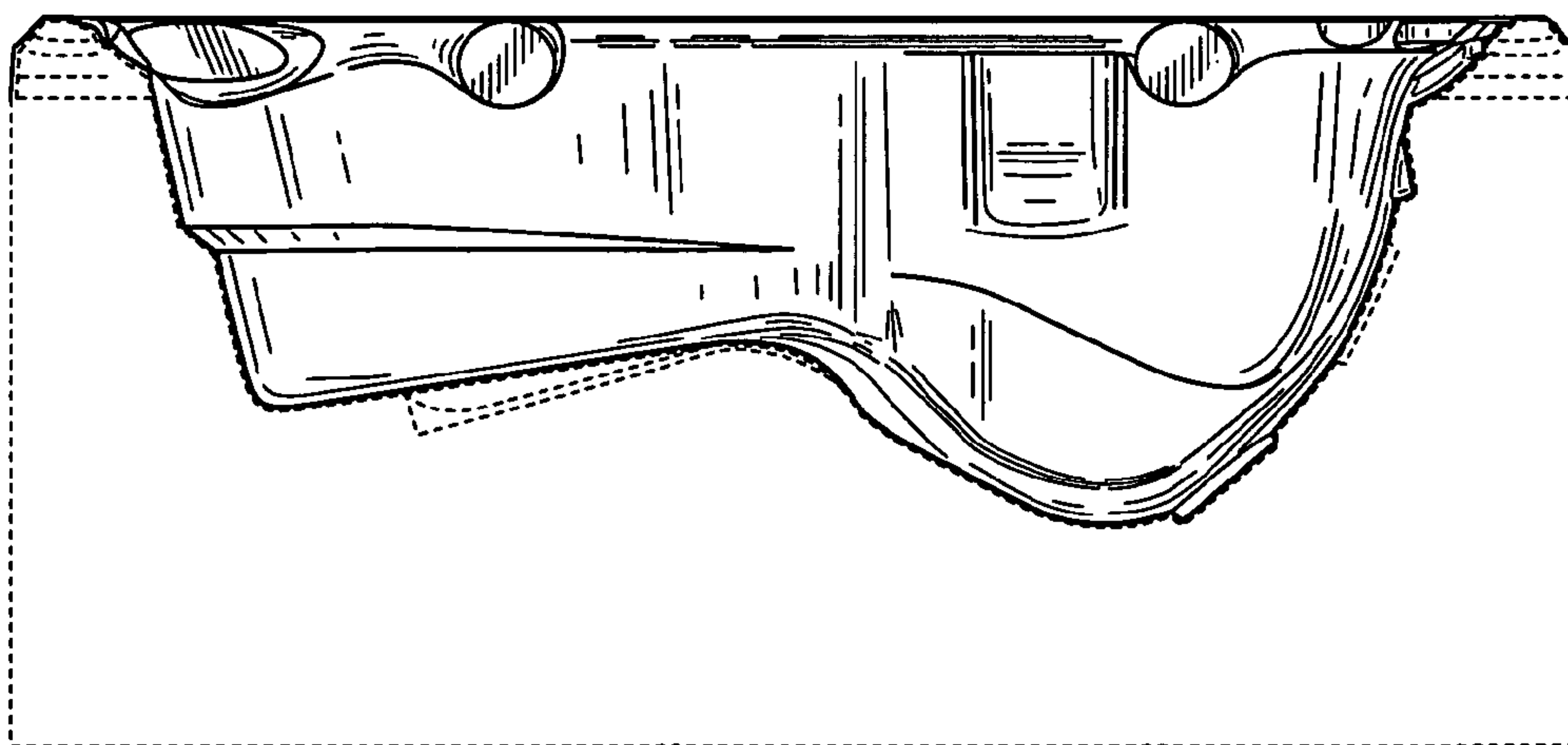

FIG. 9