



US00D641888S

(12) **United States Design Patent**  
**Jenkins et al.**

(10) **Patent No.:** **US D641,888 S**

(45) **Date of Patent:** **\*\* Jul. 19, 2011**

(54) **BABY BOTTLE**

(76) Inventors: **David Jenkins**, Hooksett, NH (US);  
**Ashley Jenkins**, Hooksett, NH (US)

(\*\*) Term: **14 Years**

(21) Appl. No.: **29/368,511**

(22) Filed: **Aug. 25, 2010**

(51) **LOC (9) Cl.** ..... **07-01**

(52) **U.S. Cl.** ..... **D24/197**

(58) **Field of Classification Search** ..... D24/193-199,  
D24/117; D7/510-511, 533-534; D9/500,  
D9/503-504, 547, 668; 215/11.1-11.6, 387,  
215/398, DIG. 8

See application file for complete search history.

(56) **References Cited**

**U.S. PATENT DOCUMENTS**

D302,038 S *	7/1989	Barber	.....	D24/197
D309,781 S *	8/1990	Sharon et al.	.....	D24/197
D317,256 S *	6/1991	Samuels	.....	D9/503
D335,450 S *	5/1993	Pezzoli et al.	.....	D9/500
D354,913 S *	1/1995	Pezzoli et al.	.....	D9/500
D465,151 S *	11/2002	Mixon	.....	D9/668

D477,668 S *	7/2003	Kipperman et al.	.....	D24/197
6,786,344 B2 *	9/2004	Kipperman et al.	.....	215/11.1
D542,923 S *	5/2007	Merkin et al.	.....	D24/197
H2199 H *	9/2007	Horton et al.	.....	D24/197
D596,492 S *	7/2009	Safdieh	.....	D9/668
D609,968 S *	2/2010	Stern	.....	D7/510
D627,234 S *	11/2010	Hanak	.....	D9/668

\* cited by examiner

*Primary Examiner* — Susan E Krakower

(74) *Attorney, Agent, or Firm* — Bay State IP; Adam J. Bruno

(57) **CLAIM**

I claim the ornamental design for a baby bottle, as shown and described.

**DESCRIPTION**

FIG. 1 is an isometric front and side view showing my new design;

FIG. 2 is a back view thereof;

FIG. 3 is a front view thereof;

FIG. 4 is a side view thereof;

FIG. 5 is a top view thereof; and,

FIG. 6 is a bottom view thereof.

**1 Claim, 3 Drawing Sheets**

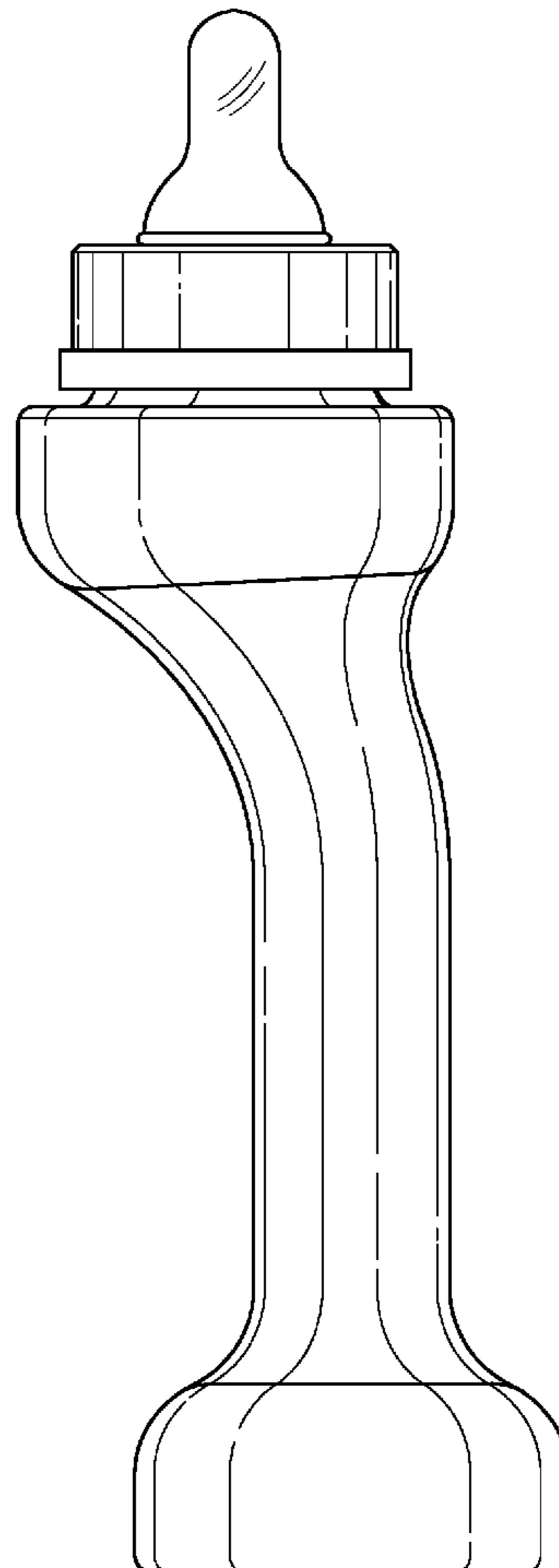
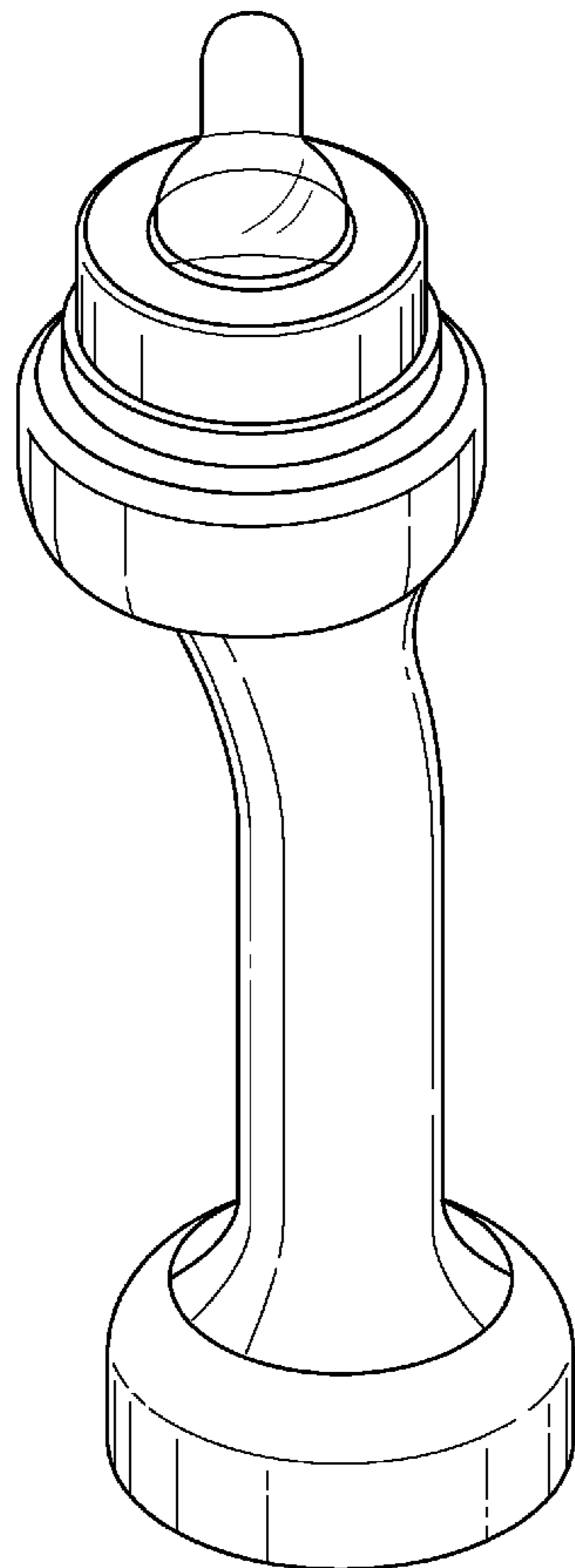

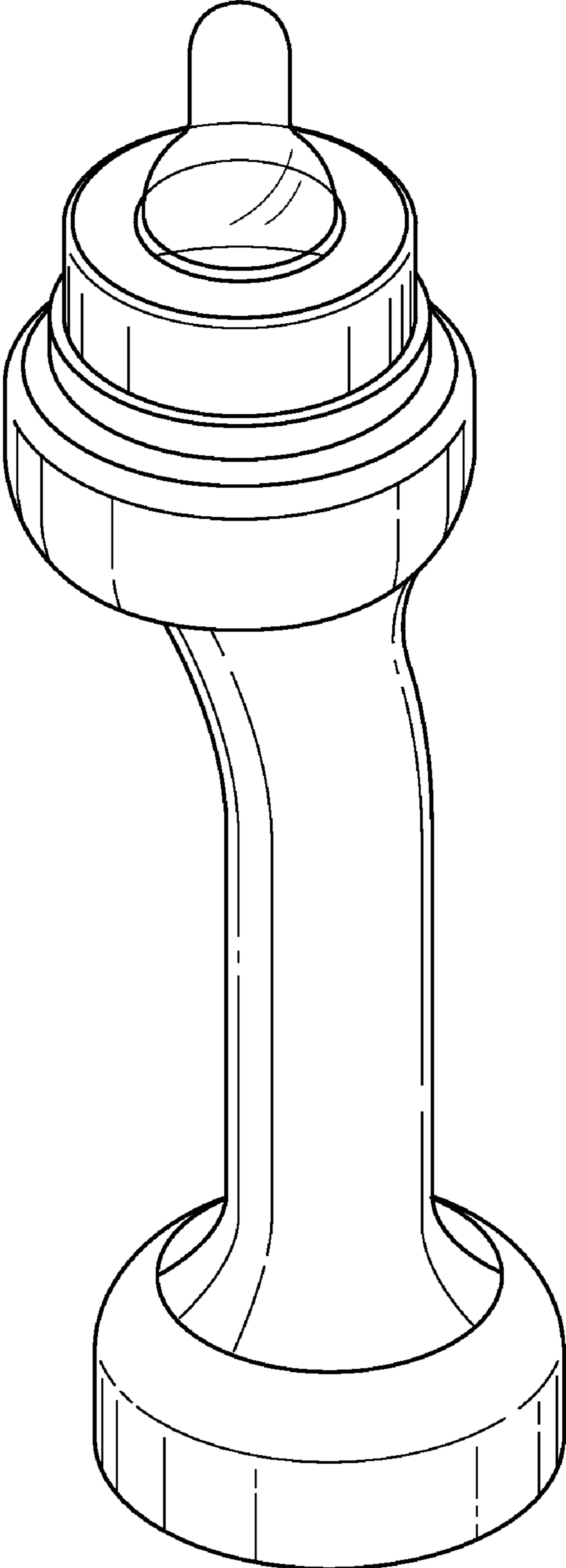

FIG. 1

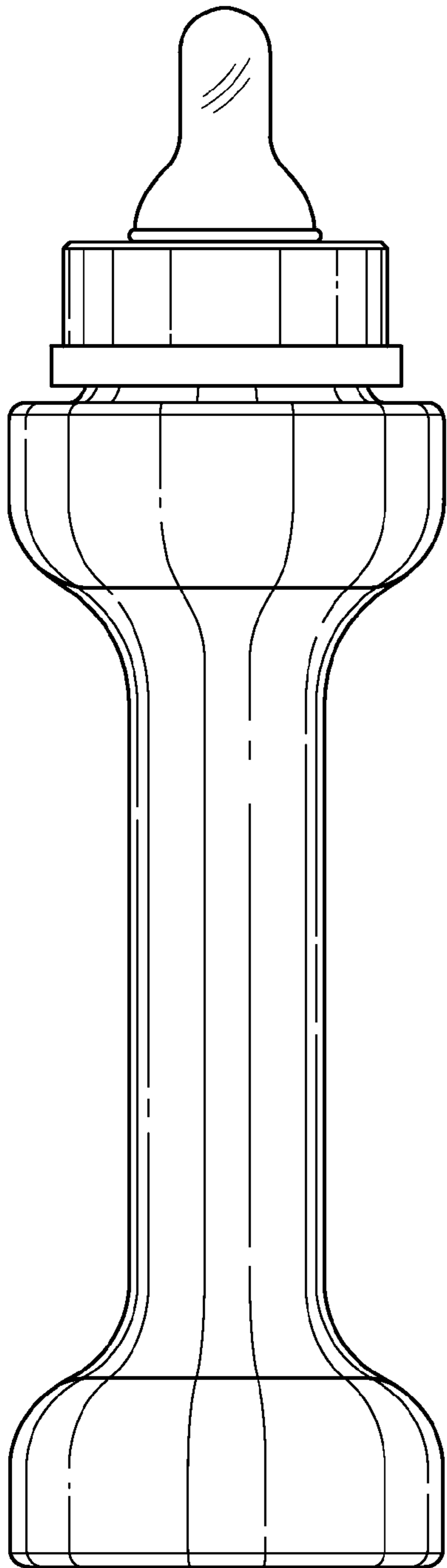

FIG. 2

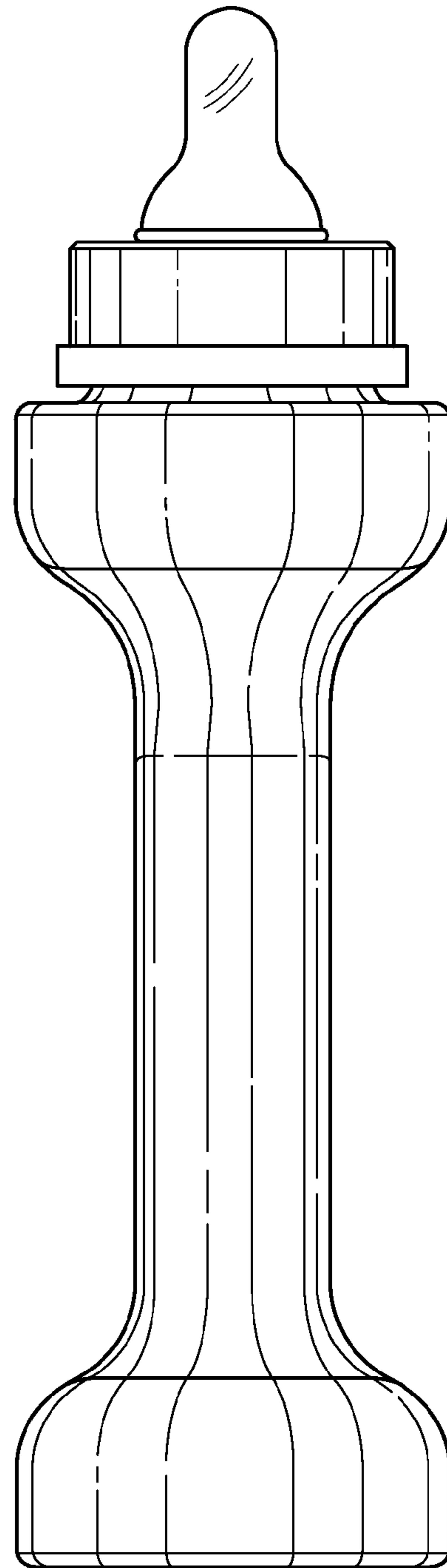

FIG. 3

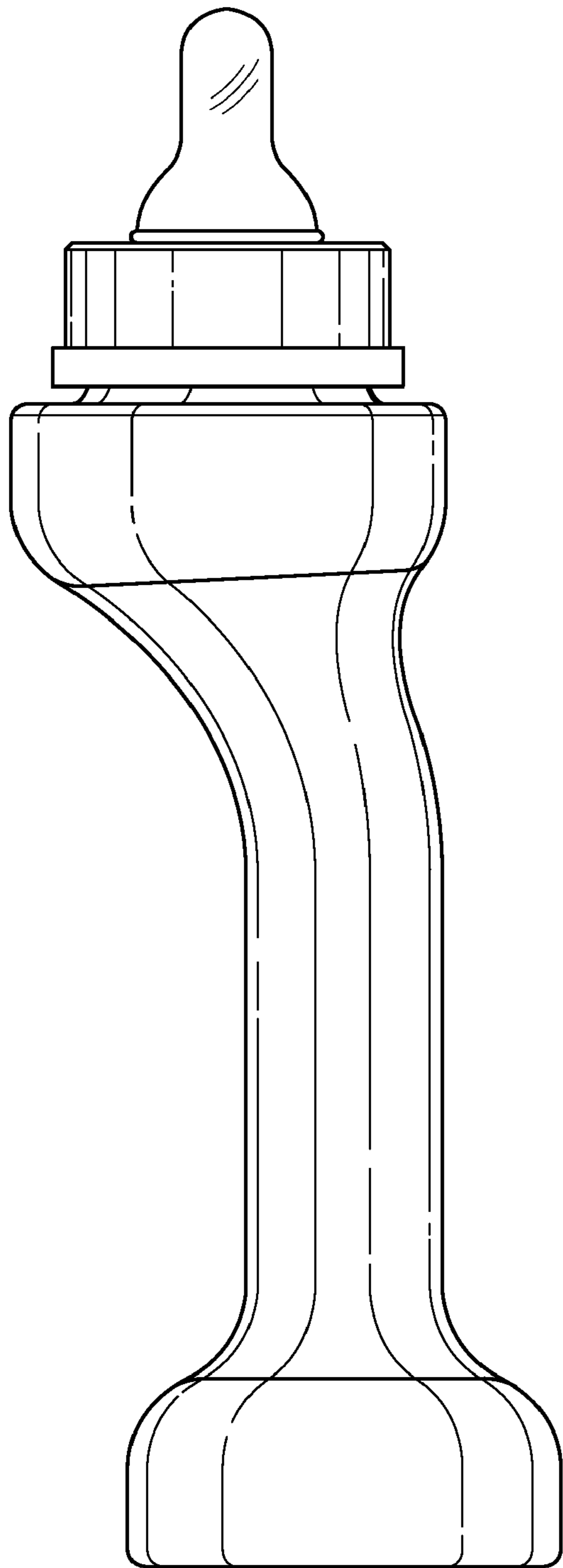

FIG. 4

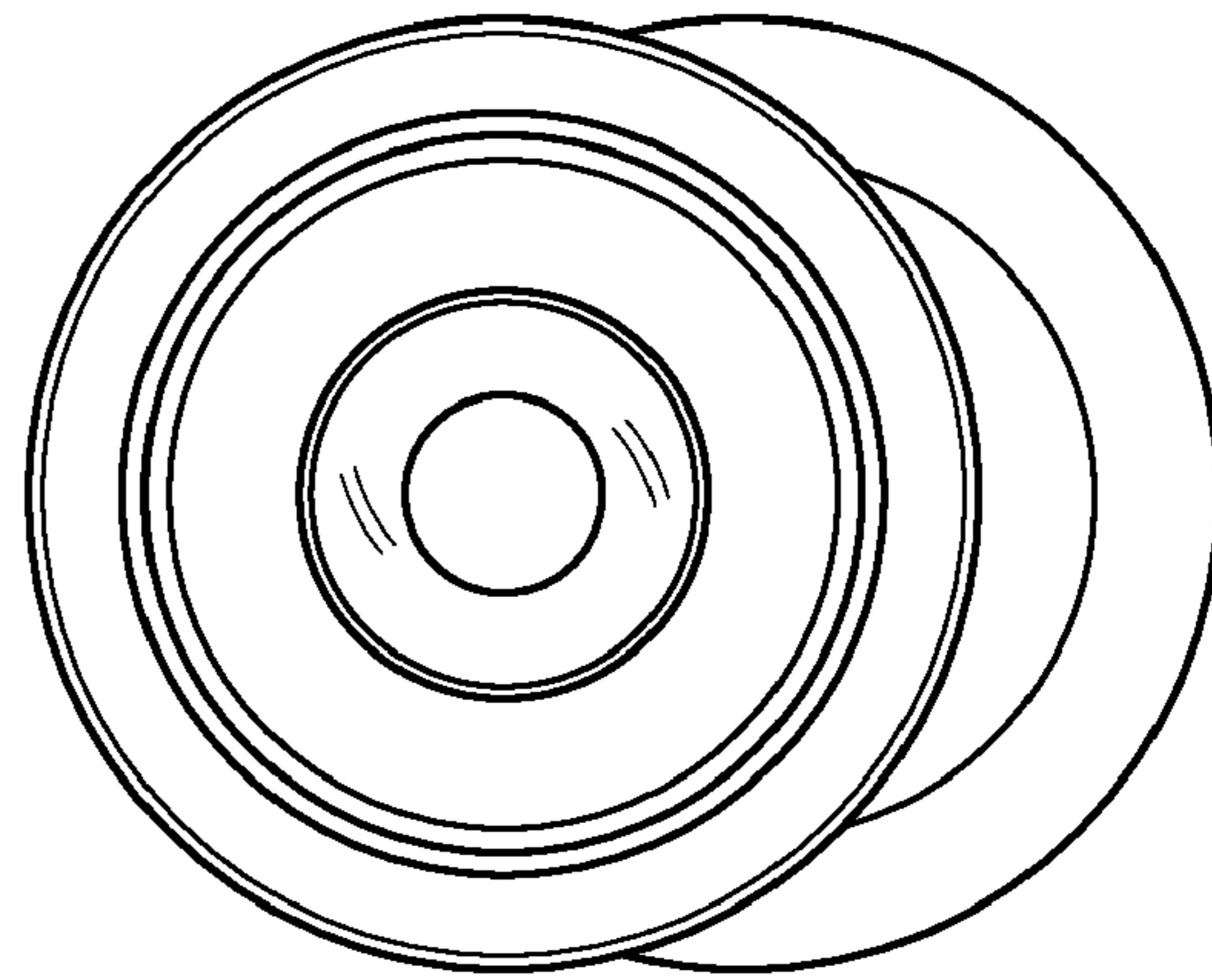

FIG. 5

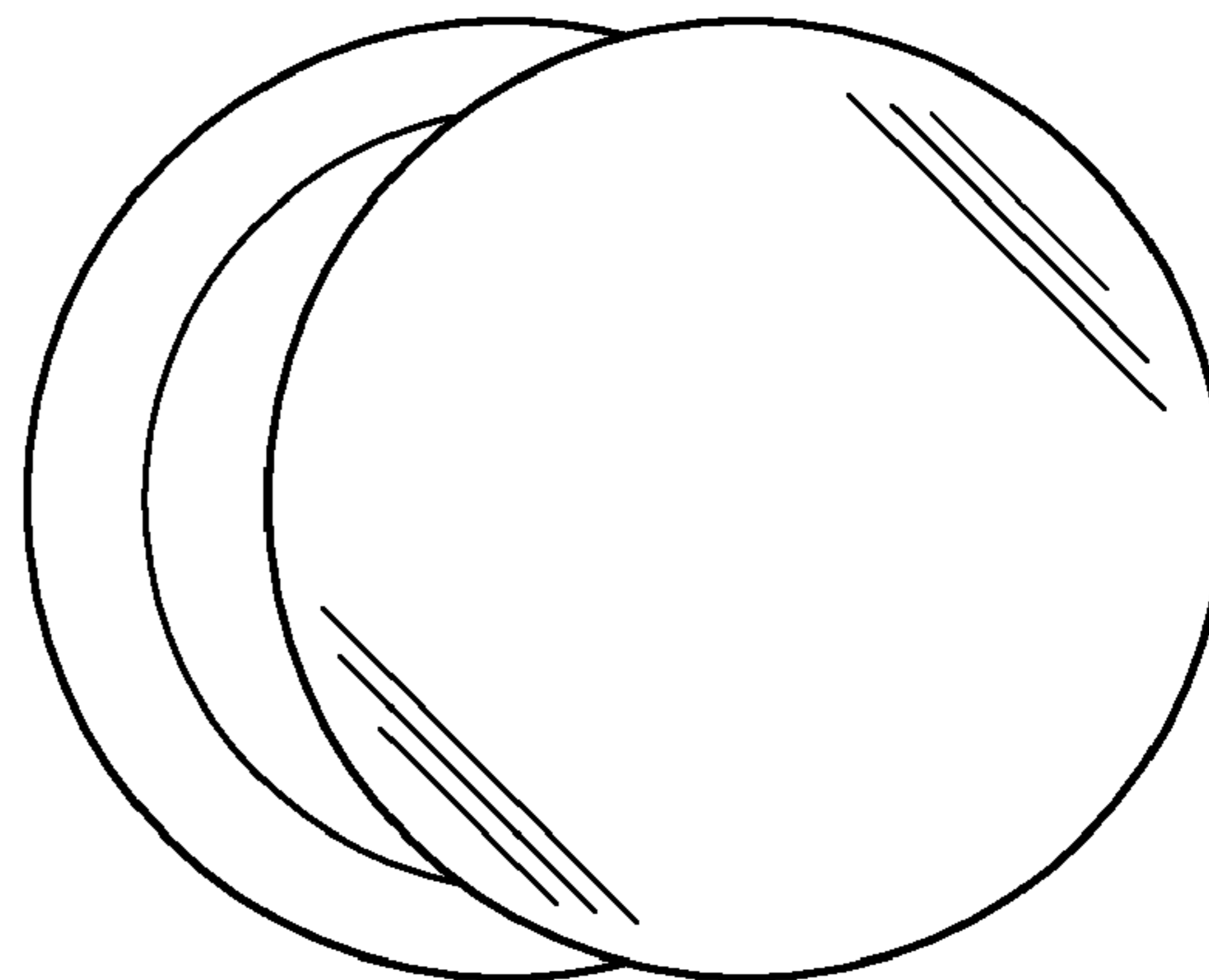

FIG. 6