

US00D641823S

(12) **United States Design Patent**  
**Hunter**

(10) **Patent No.:** **US D641,823 S**

(45) **Date of Patent:** **\*\* \*Jul. 19, 2011**

(54) **WATERSLIDE**

(75) Inventor: **Richard D Hunter**, Ottawa (CA)

(73) Assignee: **Proslide Technology, Inc.** (CA)

(\*) Notice: This patent is subject to a terminal disclaimer.

(\*\*) Term: **14 Years**

(21) Appl. No.: **29/346,755**

(22) Filed: **Nov. 5, 2009**

(30) **Foreign Application Priority Data**

Sep. 17, 2009 (CA) ..... 132175

(51) **LOC (9) Cl.** ..... **21-03**

(52) **U.S. Cl.** ..... **D21/819**

(58) **Field of Classification Search** ..... D21/818-822;  
472/116-117

See application file for complete search history.

(56) **References Cited**

**U.S. PATENT DOCUMENTS**

D250,784 S *	1/1979	Dieter et al.	.....	D21/821
D256,827 S *	9/1980	Allen, 3rd	.....	D21/819
D256,828 S *	9/1980	Allen, 3rd	.....	D21/819
D256,940 S *	9/1980	Allen, 3rd	.....	D21/819
D269,104 S *	5/1983	Brown	.....	D21/819
D269,105 S *	5/1983	Brown	.....	D21/819
D269,106 S *	5/1983	Brown	.....	D21/819
D269,107 S *	5/1983	Brown	.....	D21/819
4,487,411 A *	12/1984	Ahrens	.....	472/116
D328,119 S *	7/1992	Matsch	.....	D21/821
D330,579 S *	10/1992	Briggs	.....	D21/822
D344,317 S *	2/1994	Petersheim	.....	D21/821

D372,065 S *	7/1996	Gilles	.....	D21/821
D429,788 S *	8/2000	Sutton et al.	.....	D21/818
6,342,014 B1 *	1/2002	Lynch	.....	472/116
D524,895 S *	7/2006	VanDeusen et al.	.....	D21/820
D619,186 S *	7/2010	Strall	.....	D21/818

\* cited by examiner

*Primary Examiner* — Mitchell I Siegel

(74) *Attorney, Agent, or Firm* — Barnes & Thornburg LLP

(57) **CLAIM**

The ornamental design for a waterslide, as shown and described.

**DESCRIPTION**

FIG. 1 is a perspective view of the waterslide showing the design;

FIG. 2 is an enlarged perspective view of FIG. 1;

FIG. 3 is a top view of the waterslide of FIG. 1;

FIG. 4 is a bottom view of the waterslide of FIG. 1;

FIG. 5 is an enlarged front view of the waterslide of FIG. 1;

FIG. 6 is an enlarged rear view of the waterslide of FIG. 1;

FIG. 7 is a right side view of the waterslide of FIG. 1;

FIG. 8 is a left side view of the waterslide of FIG. 1;

FIG. 9 is a perspective view of a second embodiment of the waterslide of FIG. 1;

FIG. 10 is an enlarged perspective view of FIG. 9;

FIG. 11 is a top view of the waterslide of FIG. 9;

FIG. 12 is a bottom view of the waterslide of FIG. 9;

FIG. 13 is an enlarged front view of the waterslide of FIG. 9;

FIG. 14 is an enlarged rear view of the waterslide of FIG. 9;

FIG. 15 is a right side view of the waterslide of FIG. 9; and,

FIG. 16 is a left side view of the waterslide of FIG. 9.

The broken line showing is included for the purpose of illustrating and forms no part of the claimed design.

**1 Claim, 12 Drawing Sheets**

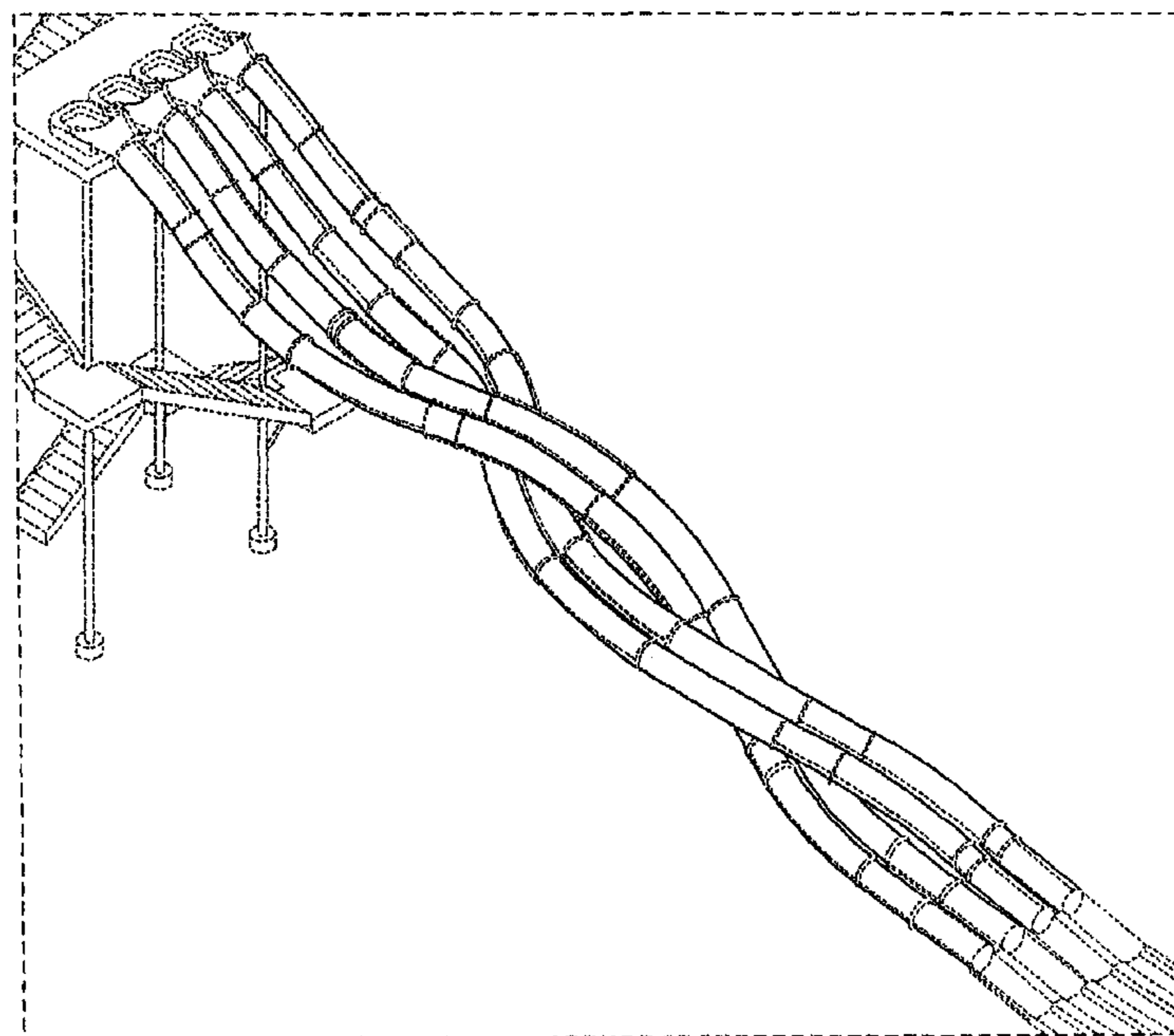

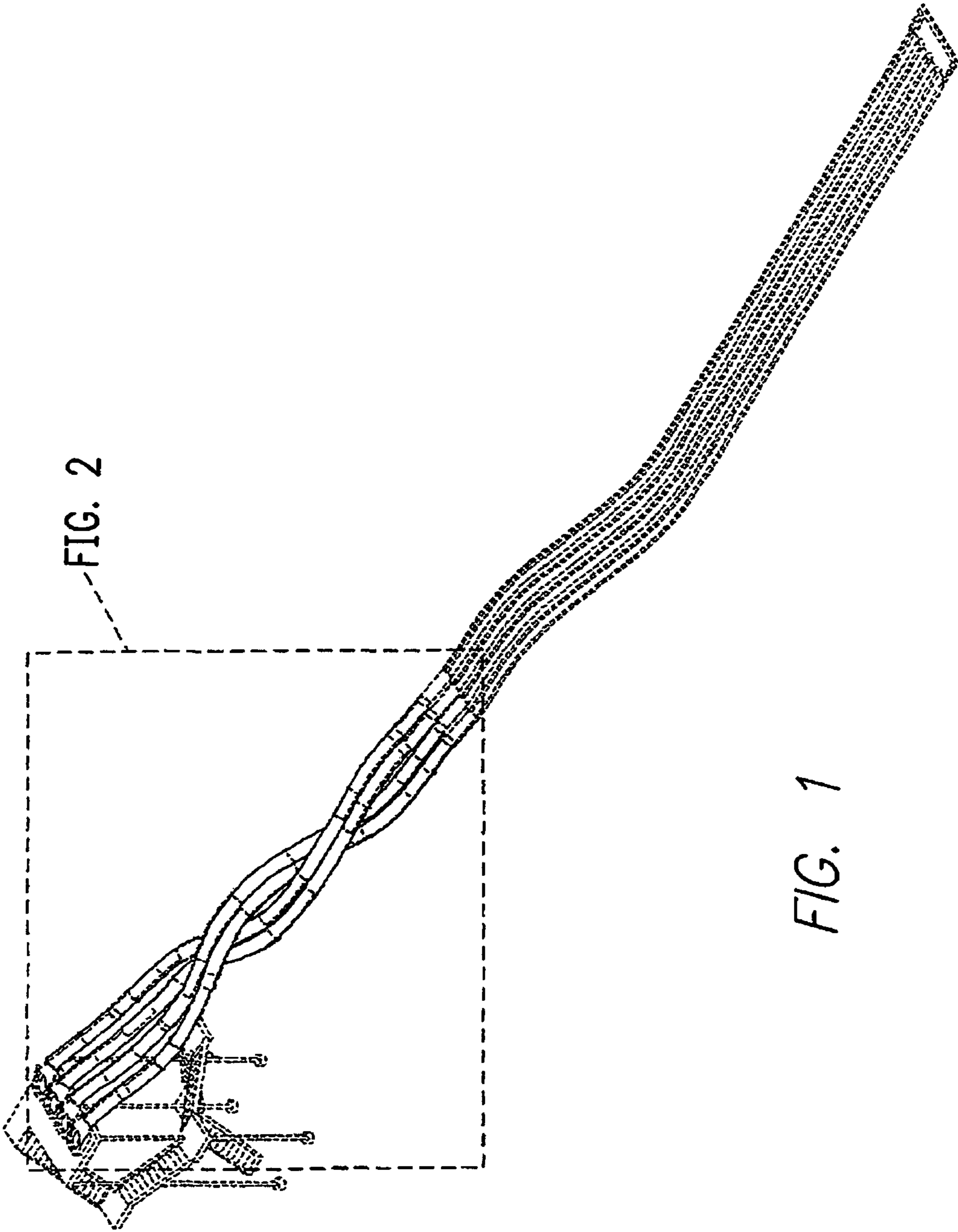

FIG. 1

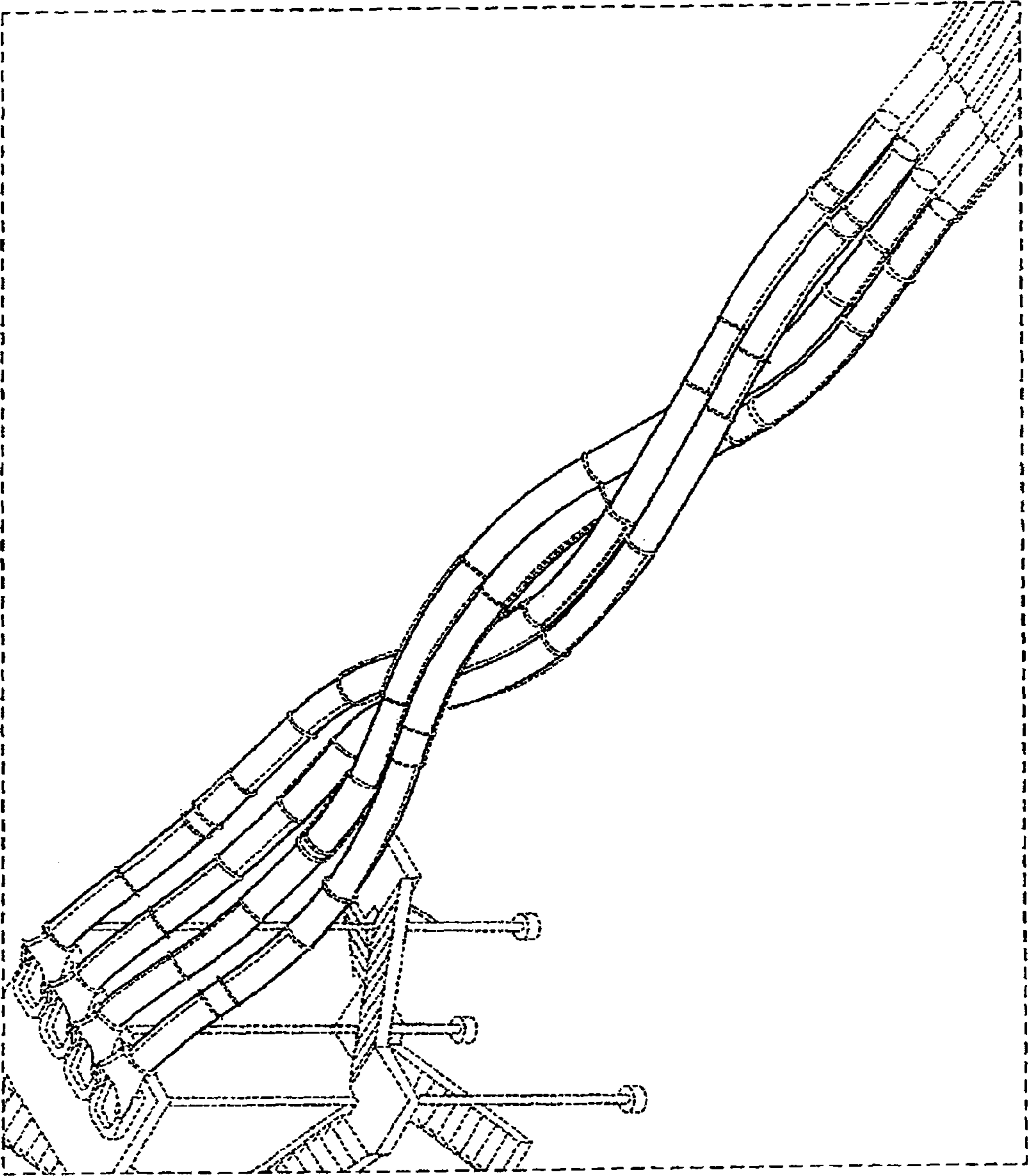

FIG. 2

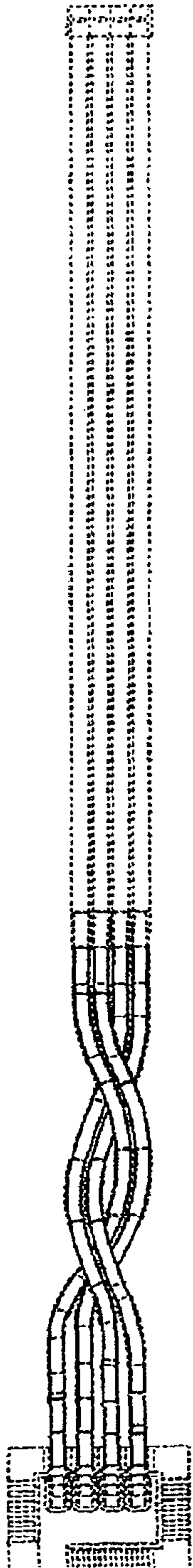

FIG. 3

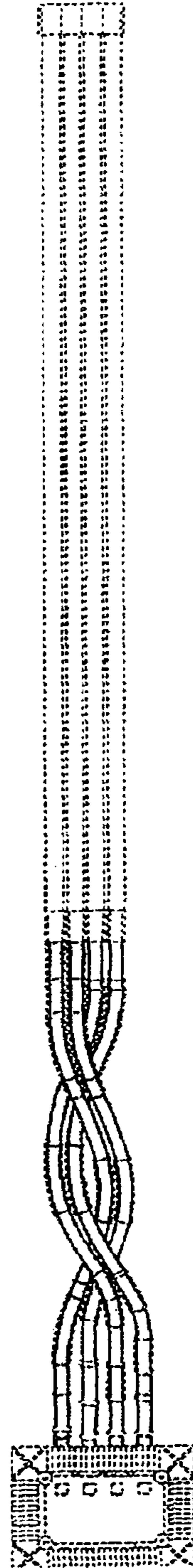

FIG. 4

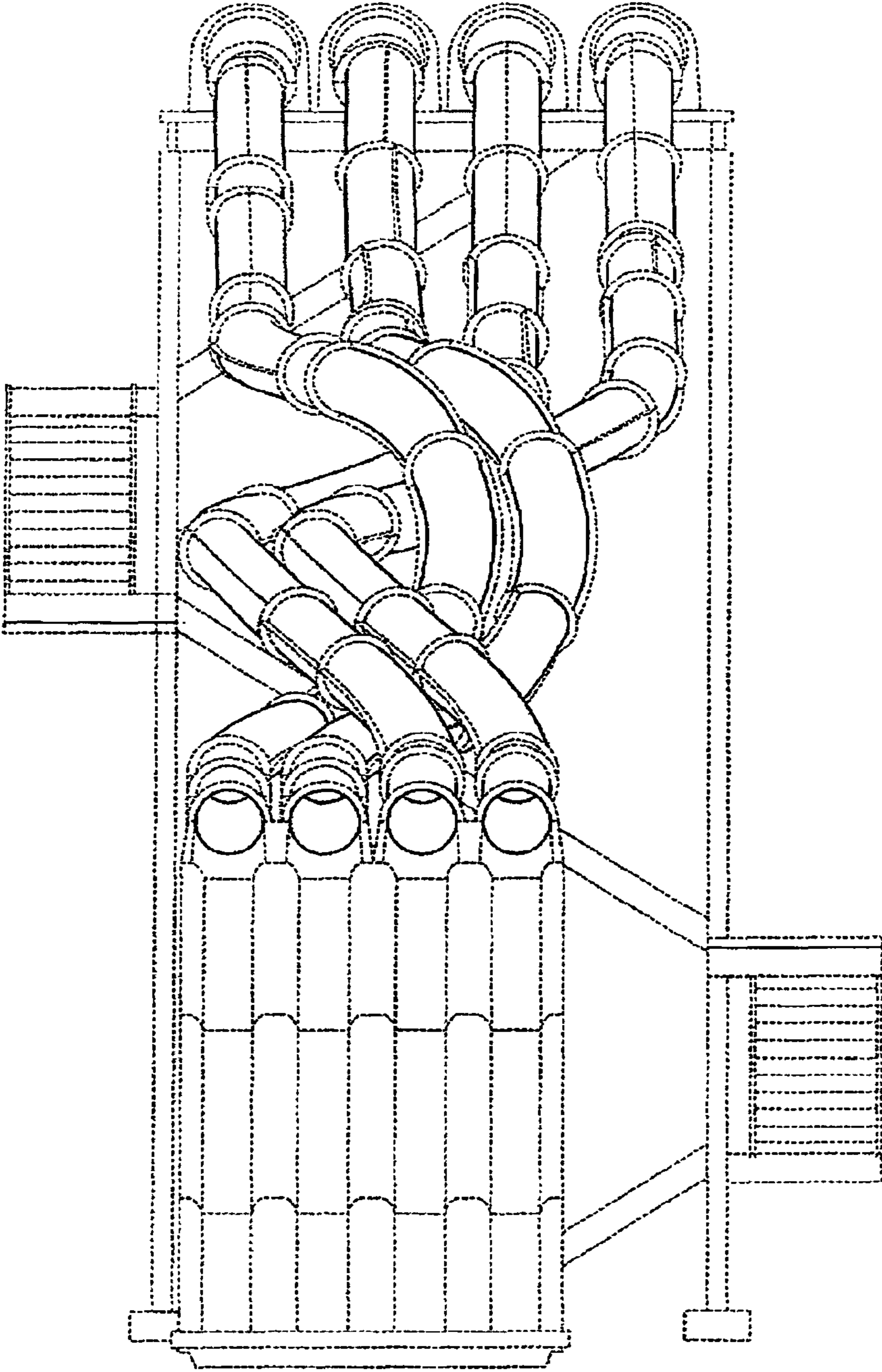

FIG. 5

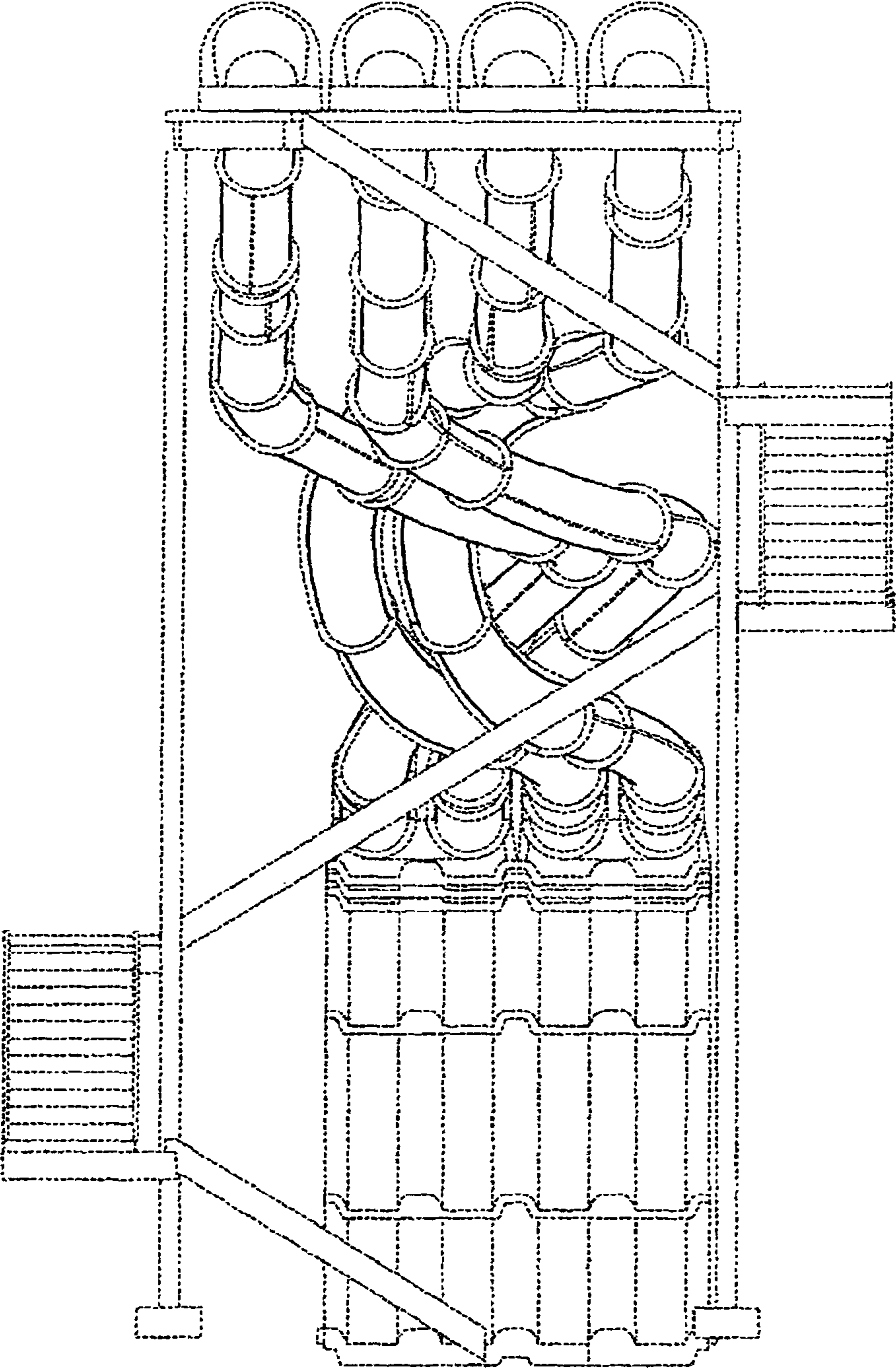

FIG. 6

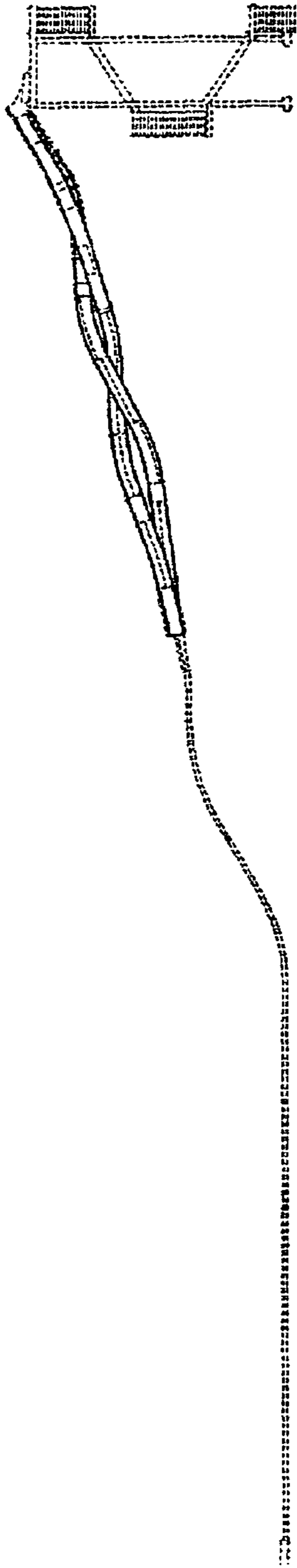

FIG. 7

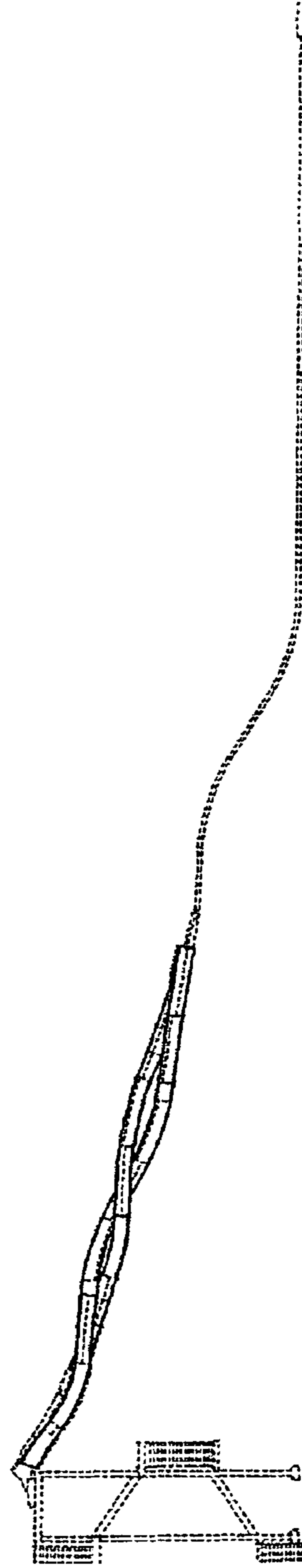

FIG. 8

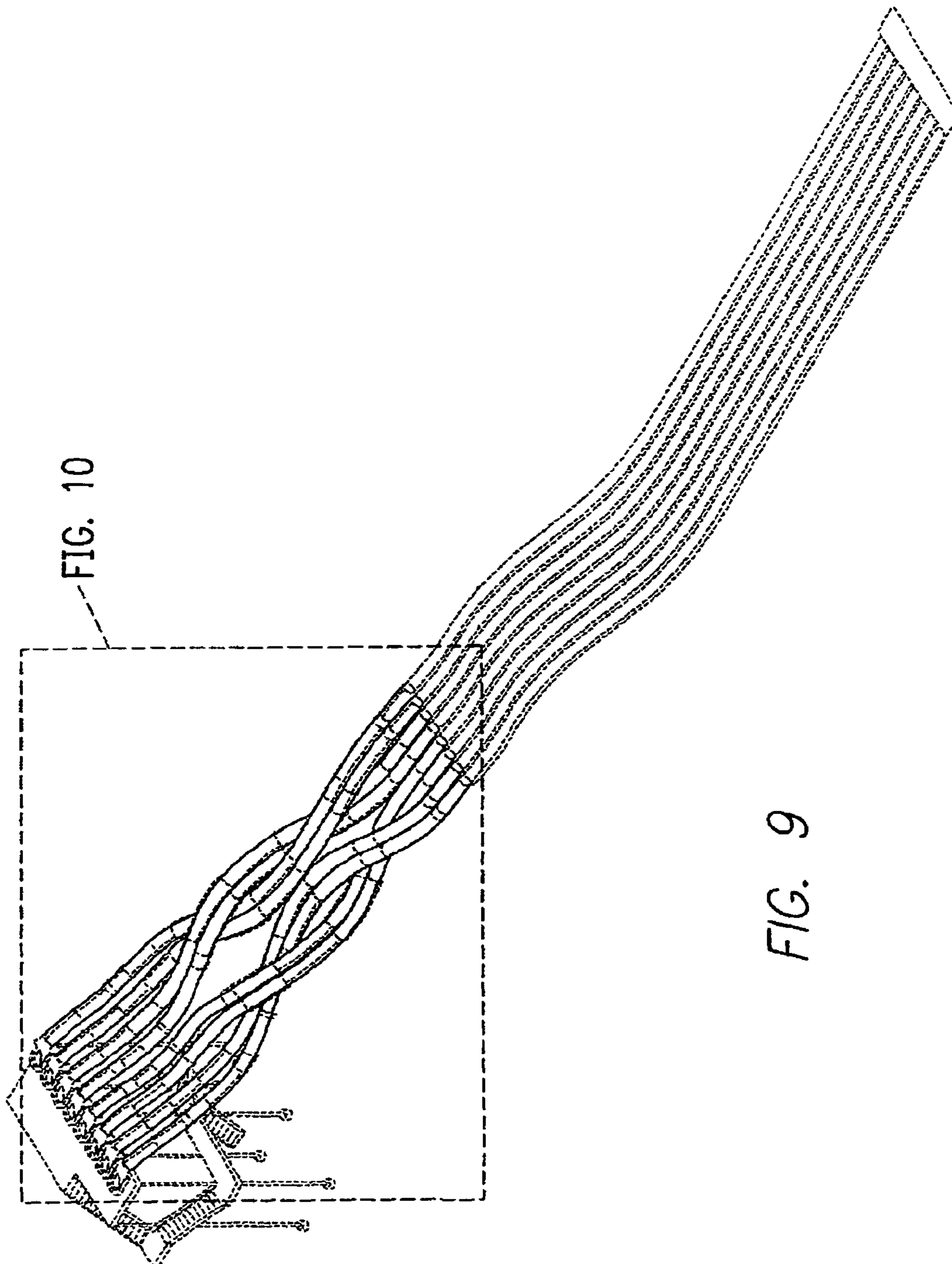

FIG. 10

FIG. 9



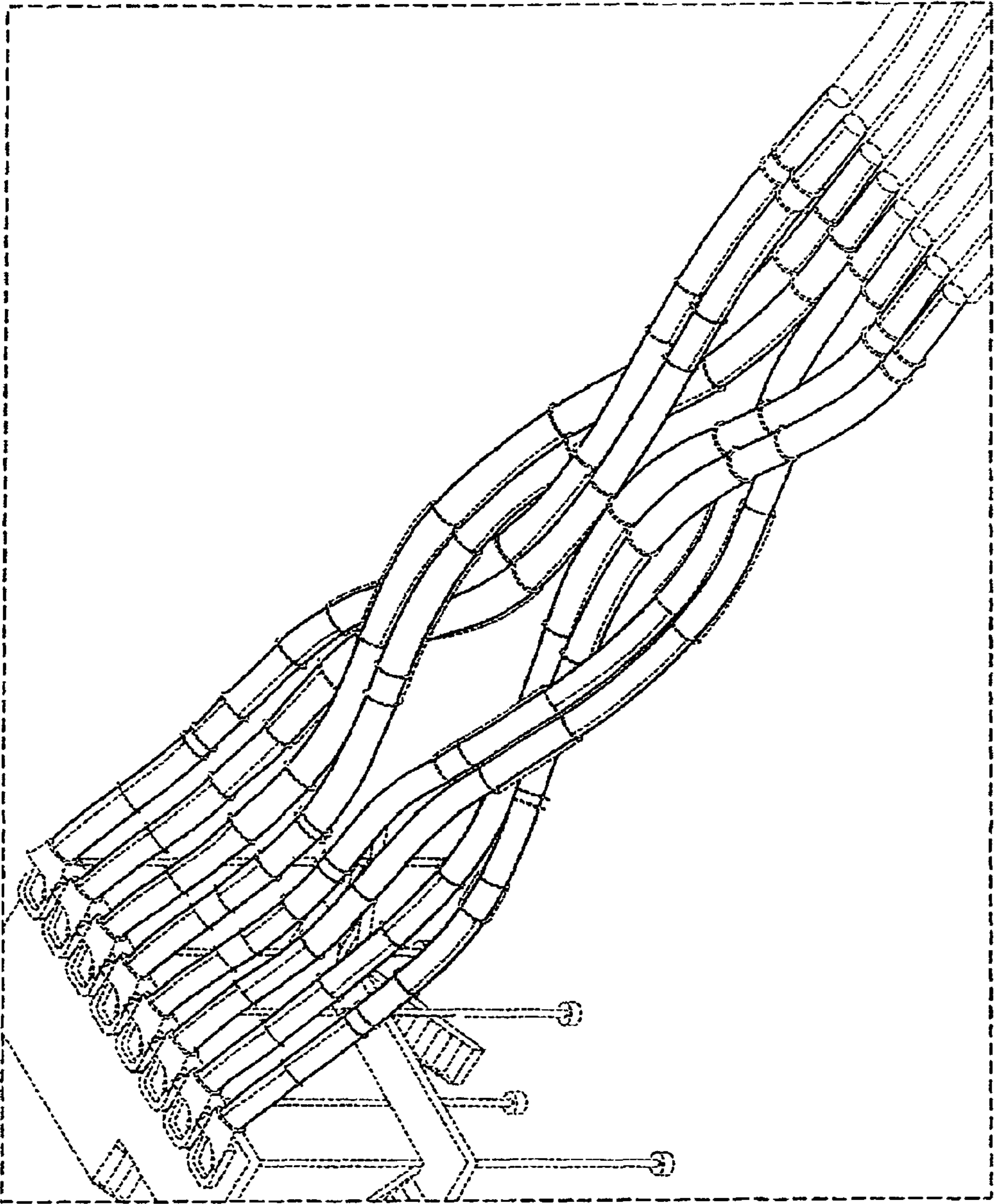

FIG. 10

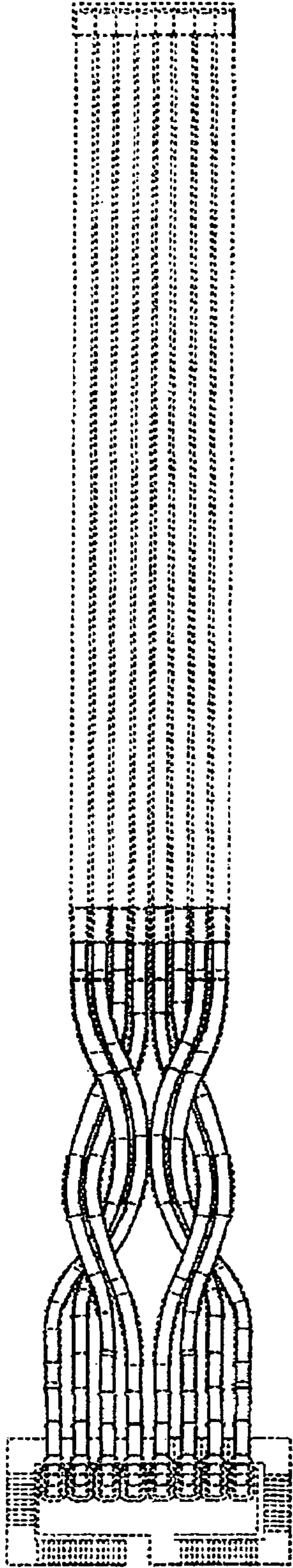

FIG. 11

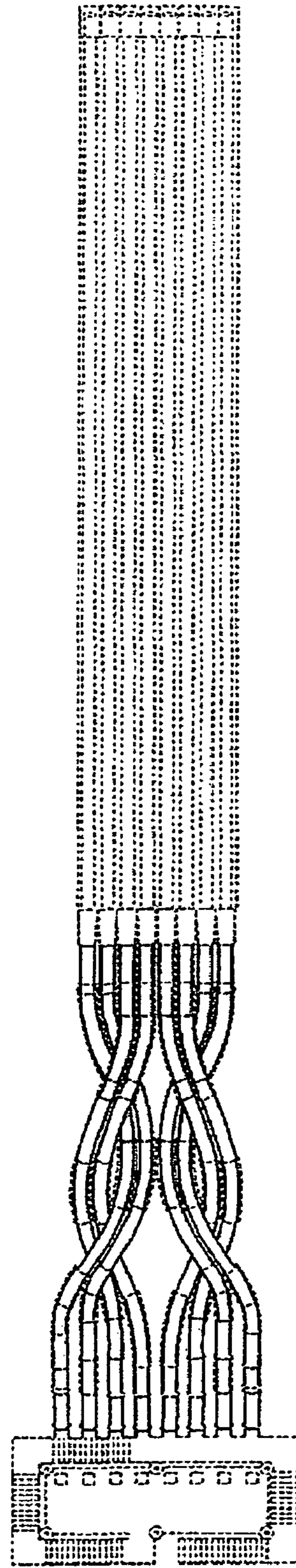

FIG. 12

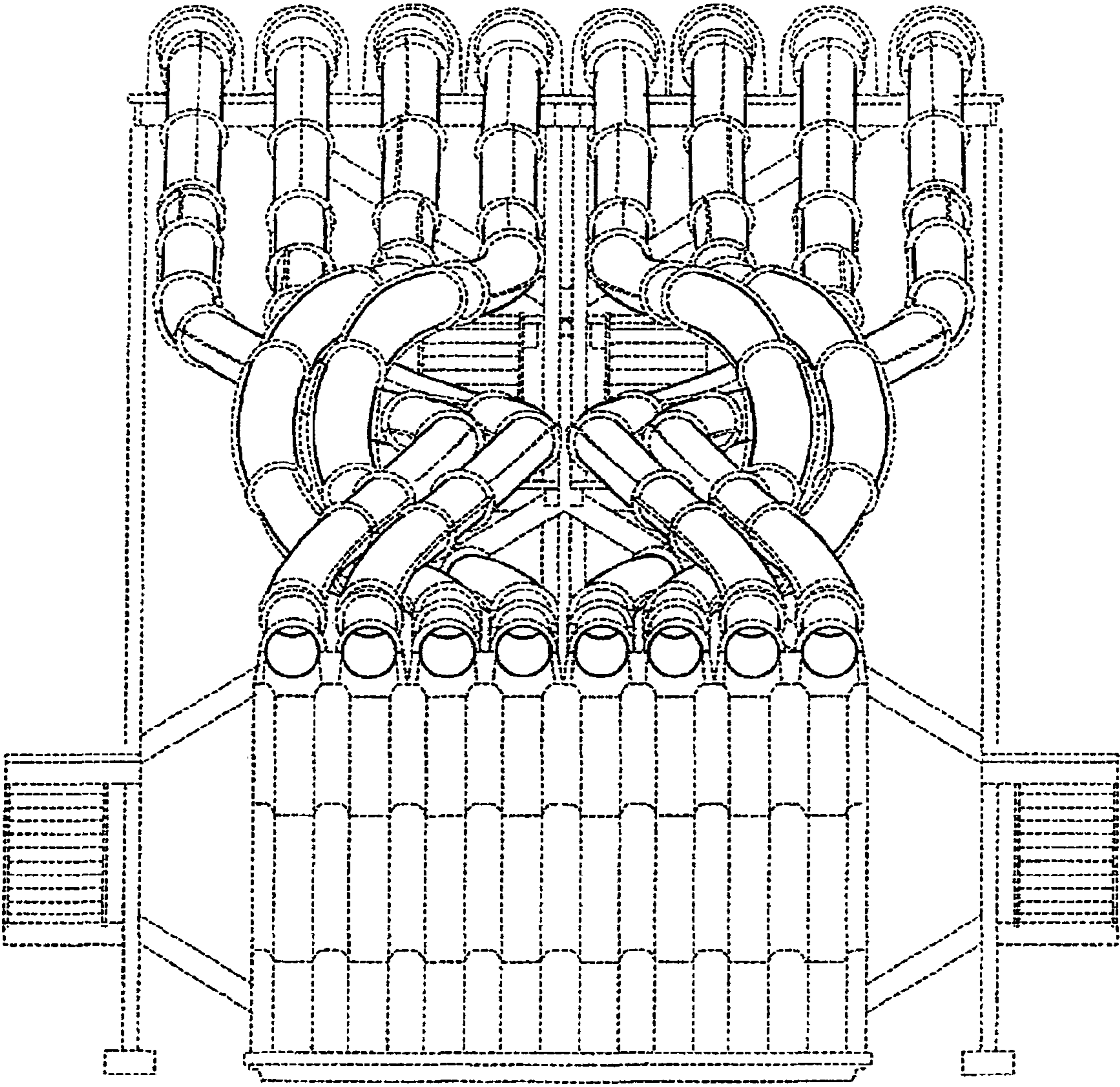

FIG. 13

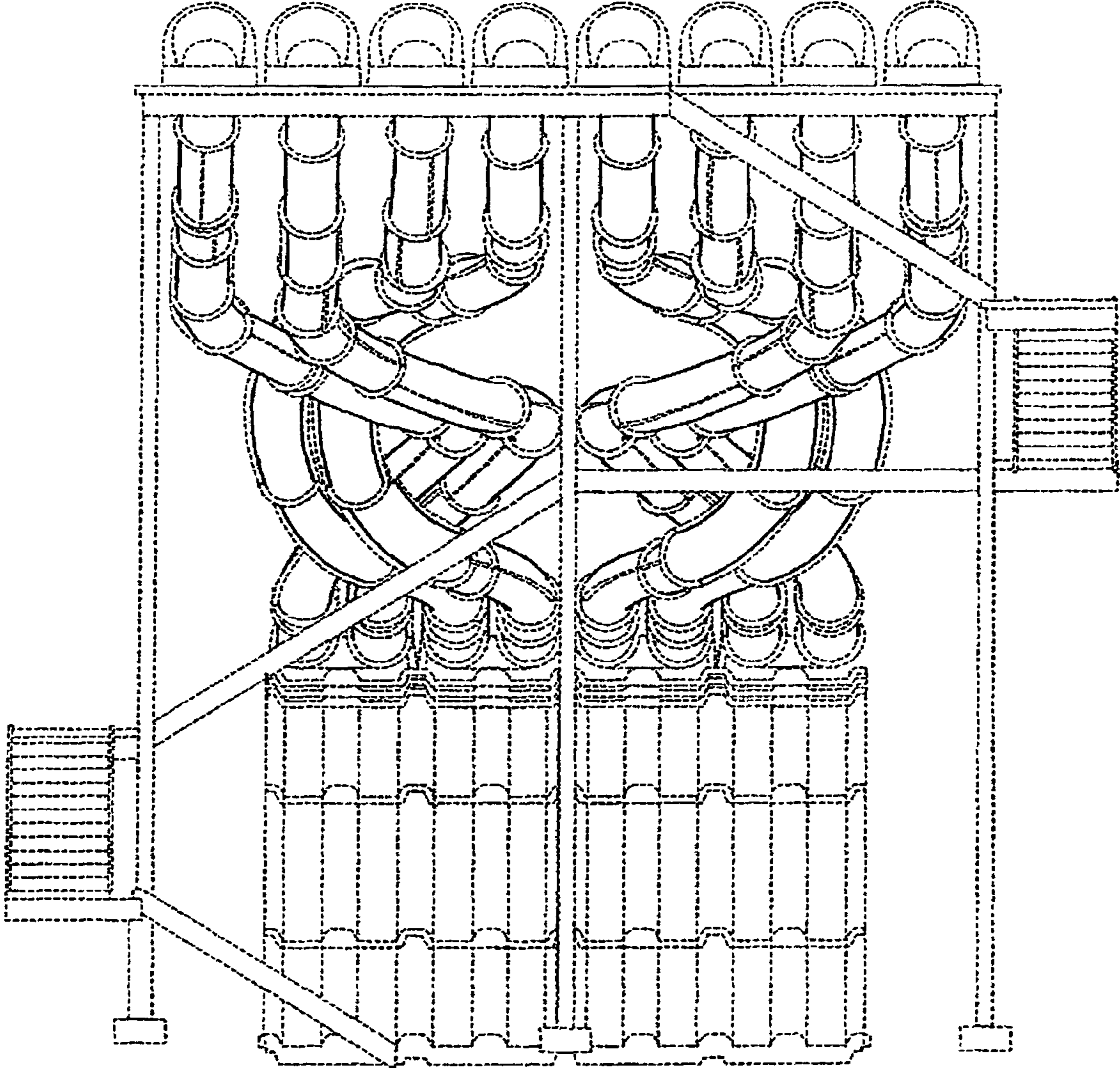

FIG. 14

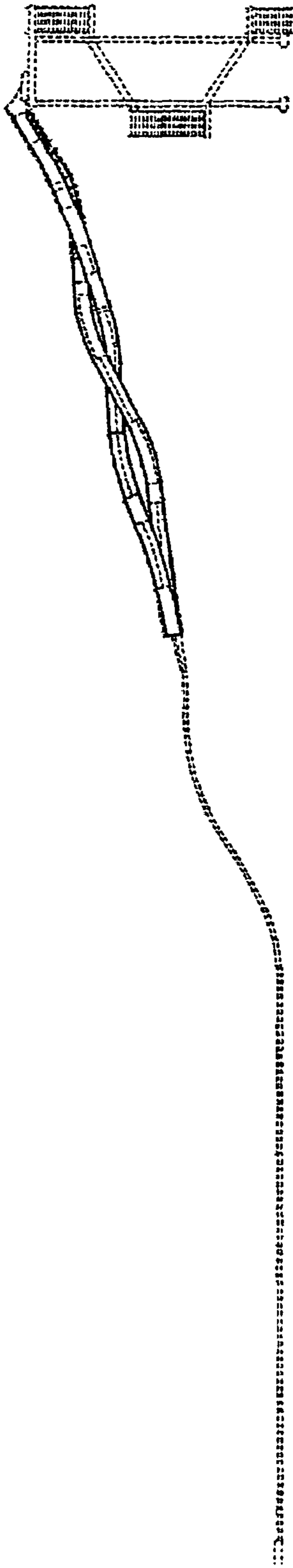

FIG. 15

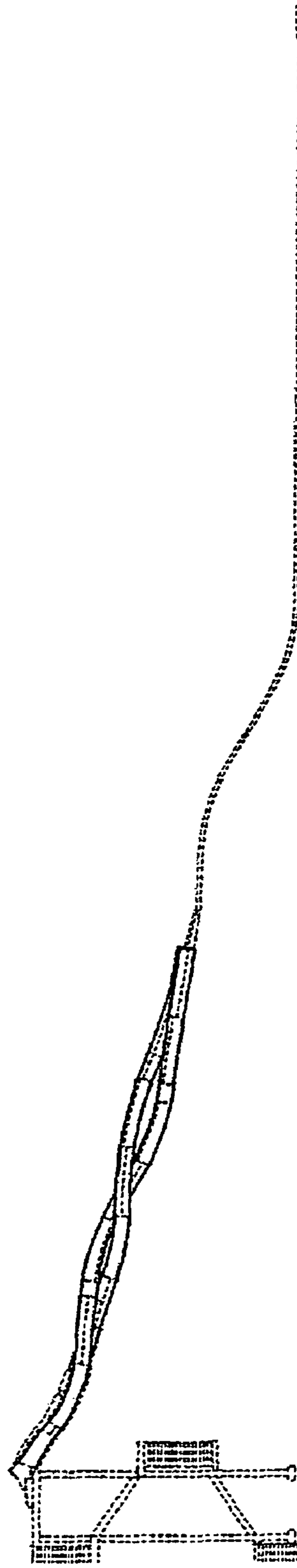

FIG. 16