



US00D641792S

(12) **United States Design Patent**
Turner et al.

(10) **Patent No.:** **US D641,792 S**

(45) **Date of Patent:** **** *Jul. 19, 2011**

- (54) **MOUNTABLE CARD ASSEMBLY**
- (75) Inventors: **James F. Turner**, Farmington Hills, MI (US); **Scott D. Best**, Troy, MI (US)
- (73) Assignee: **Saxon Inc.**, Ferndale, MI (US)
- (**) Term: **14 Years**
- (21) Appl. No.: **29/355,898**
- (22) Filed: **Feb. 16, 2010**
- (51) **LOC (9) Cl.** **20-02**
- (52) **U.S. Cl.** **D20/40; D19/11**
- (58) **Field of Classification Search** D20/10-12, D20/19, 22-28, 40, 99; 40/1.5, 1.6, 5, 6, 40/27, 124.01-124.09, 124.11, 124.19, 124.191, 40/299.01, 312, 313, 360, 538, 539, 630, 40/638, 641, 661.08, 662; D19/1, 2, 9-11; 235/379, 380, 487, 489, 473; 283/51, 56, 283/62, 71, 72, 101, 105, 81, 904; 428/34.1, 428/40.1, 42.1-42.3, 43, 195.1, 211.1, 914; D9/414; D14/436

See application file for complete search history.

6,588,658	B1 *	7/2003	Blank	235/380
D487,907	S *	3/2004	Kumakura	D20/22
D493,840	S *	8/2004	Best et al.	D20/27
D494,223	S *	8/2004	Best et al.	D20/27
D504,159	S *	4/2005	Best et al.	D20/27
6,898,880	B2 *	5/2005	Best et al.	40/299.01
6,974,159	B2 *	12/2005	Thompson et al.	283/51
7,005,170	B1 *	2/2006	Simpson et al.	428/40.1
7,032,817	B2 *	4/2006	Blank	235/380
7,140,135	B2	11/2006	Irvine et al.		
D533,220	S *	12/2006	Graves et al.	D19/9
D541,873	S *	5/2007	Turner et al.	D20/40
D541,874	S *	5/2007	Turner et al.	D20/40
D561,252	S *	2/2008	Phillips et al.	D19/10
D582,474	S *	12/2008	Phillips et al.	D19/10
D616,294	S *	5/2010	Britt et al.	D9/414
7,753,262	B2 *	7/2010	Kingsborough et al.	235/380
2003/0177674	A1	9/2003	Miller		
2005/0191449	A1 *	9/2005	Funato et al.	428/34.1
2005/0206157	A1	9/2005	Thompson et al.		
2005/0242193	A1 *	11/2005	Smith et al.	235/487
2005/0247798	A1 *	11/2005	Graves et al.	235/493
2006/0038396	A1	2/2006	Thompson et al.		
2007/0065619	A1	3/2007	Sellars		
2007/0148393	A1	6/2007	Sellars		
2008/0095963	A1 *	4/2008	Robbins	428/40.1
2008/0142394	A1	6/2008	Thuesen et al.		
2008/0283614	A1 *	11/2008	Emery	235/487
2009/0058073	A1 *	3/2009	George	283/81
2010/0019029	A1 *	1/2010	Schultz et al.	235/379

(56) **References Cited**

U.S. PATENT DOCUMENTS

3,804,323	A *	4/1974	Bemel	383/40
3,854,229	A	12/1974	Morgan		
4,306,367	A	12/1981	Otto		
4,308,679	A	1/1982	Ray, III et al.		
4,324,823	A	4/1982	Ray, III		
4,345,393	A	8/1982	Price et al.		
4,359,358	A	11/1982	Hattemer		
4,620,664	A	11/1986	Kaufman et al.		
4,767,654	A	8/1988	Riggsbee		
5,343,647	A *	9/1994	Bulka	40/630
5,417,458	A *	5/1995	Best et al.	283/51
5,571,358	A	11/1996	Napier et al.		
5,684,291	A *	11/1997	Taskett	235/487
D394,675	S *	5/1998	Haas et al.	D20/27
5,824,380	A	10/1998	Hagen		
5,992,888	A *	11/1999	North et al.	283/56
6,042,149	A	3/2000	Roshkoff		
6,241,287	B1	6/2001	Best et al.		
6,402,086	B1	6/2002	Myers, Jr.		

FOREIGN PATENT DOCUMENTS

GB 1292962 10/1972

OTHER PUBLICATIONS

U.S. Des. Appl. No. 29/365,058; filed Jul. 2, 2010; 4 pages.
U.S. Appl. No. 12/874,316; filed Sep. 2, 2010; 38 pages.

* cited by examiner

Primary Examiner — Mary Ann Calabrese
(74) *Attorney, Agent, or Firm* — Howard & Howard Attorneys PLLC

(57) **CLAIM**

The ornamental design for a mountable card assembly, as shown and described.

DESCRIPTION

FIG. 1 is a perspective view of a first embodiment of a mountable card assembly of the present invention wherein the

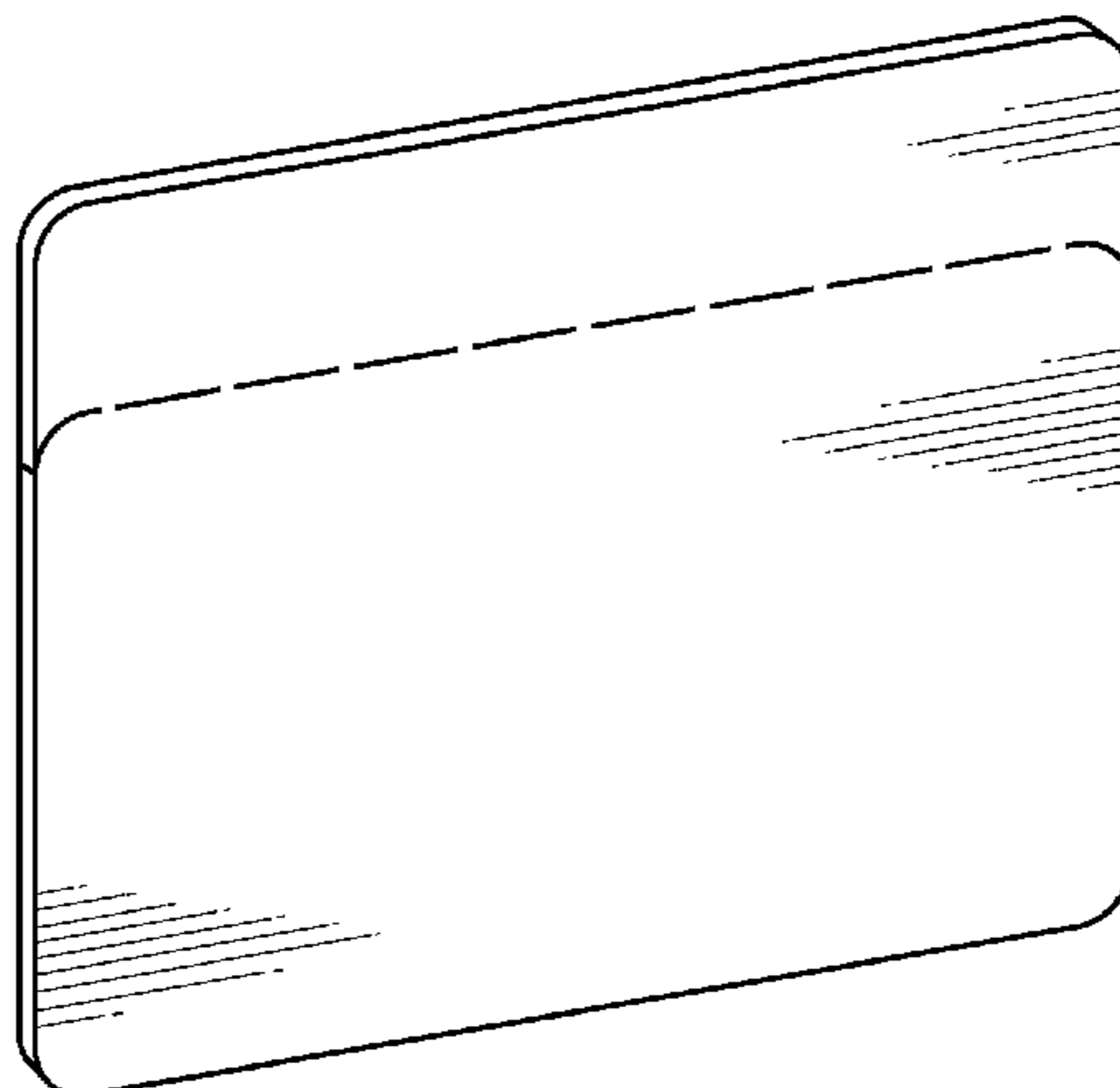

mountable card assembly of this embodiment includes a mountable portion and a card portion;

FIG. 2 is a front view of the mountable card assembly of FIG. 1;

FIG. 3 is a rear view of the mountable card assembly of FIG. 1 showing a number of coupons in dash-dot-dot-dash broken lines;

FIG. 4 is a top side elevational view of the mountable card assembly of FIG. 2;

FIG. 5 is a bottom side elevational view of the mountable card assembly of FIG. 2;

FIG. 6 is a right side elevational view of the mountable card assembly of FIG. 2;

FIG. 7 is a left side elevational view of the mountable card assembly of FIG. 2;

FIG. 8 a perspective view of a second embodiment of the mountable card assembly of the present invention wherein the mountable card assembly of this embodiment includes a mountable portion, a first card portion, and a second card portion;

FIG. 9 is a front view of the mountable card assembly of FIG. 8;

FIG. 10 is a rear view of the mountable card assembly of FIG. 8 showing a number of coupons in dash-dot-dot-dash broken lines;

FIG. 11 is a top side elevational view of the mountable card assembly of FIG. 9;

FIG. 12 is a bottom side elevational view of the mountable card assembly of FIG. 9;

FIG. 13 is a right side elevational view of the mountable card assembly of FIG. 9;

FIG. 14 is a left side elevational view of the mountable card assembly of FIG. 9;

FIG. 15 a perspective view of a third embodiment of the mountable card assembly of the present invention wherein the mountable card assembly of this embodiment includes a mountable portion, a first card portion, and a second card portion;

FIG. 16 is a front view of the mountable card assembly of FIG. 15;

FIG. 17 is a rear view of the mountable card assembly of FIG. 15 showing a number of coupons in dash-dot-dot-dash broken lines;

FIG. 18 is a top side elevational view of the mountable card assembly of FIG. 16;

FIG. 19 is a bottom side elevational view of the mountable card assembly of FIG. 16;

FIG. 20 is a right side elevational view of the mountable card assembly of FIG. 16;

FIG. 21 is a left side elevational view of the mountable card assembly of FIG. 16;

FIG. 22 is a perspective view of a fourth embodiment of the mountable card assembly of the present invention wherein the mountable card assembly of this embodiment includes a mountable portion, a first card portion, and a second card portion;

FIG. 23 is a front view of the mountable card assembly of FIG. 22;

FIG. 24 is a rear view of the mountable card assembly of FIG. 22 showing a number of coupons in dash-dot-dot-dash broken lines;

FIG. 25 is a top side elevational view of the mountable card assembly of FIG. 23;

FIG. 26 is a bottom side elevational view of the mountable card assembly of FIG. 23;

FIG. 27 is a right side elevational view of the mountable card assembly of FIG. 23; and,

FIG. 28 is a left side elevational view of the mountable card assembly of FIG. 23.

The elements shown in dash-dot-dot-dash broken line represent coupons and form no part of the claimed design. The evenly spaced broken lines represent perforations forming part of the claimed design.

1 Claim, 8 Drawing Sheets

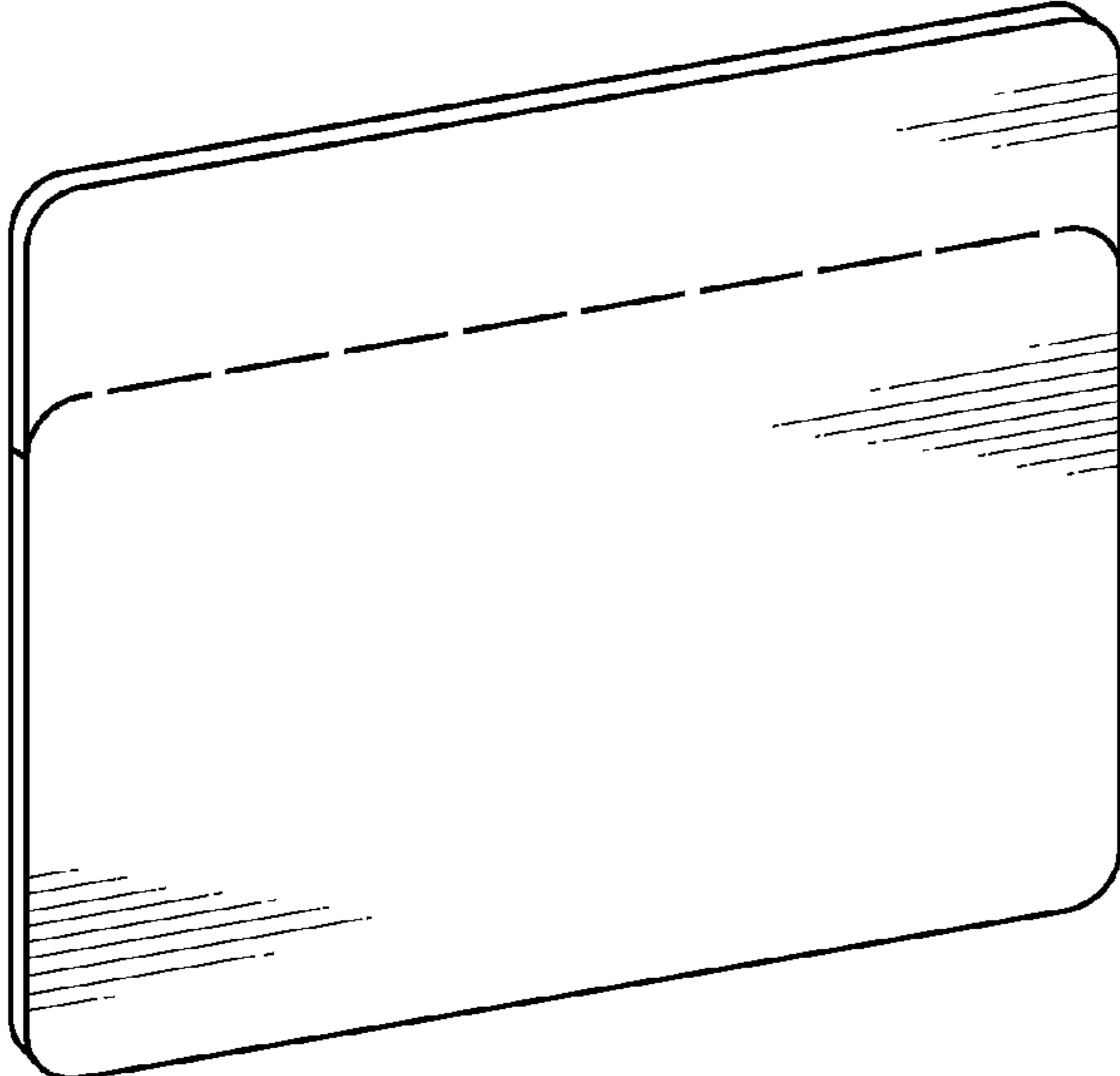

FIG. 1

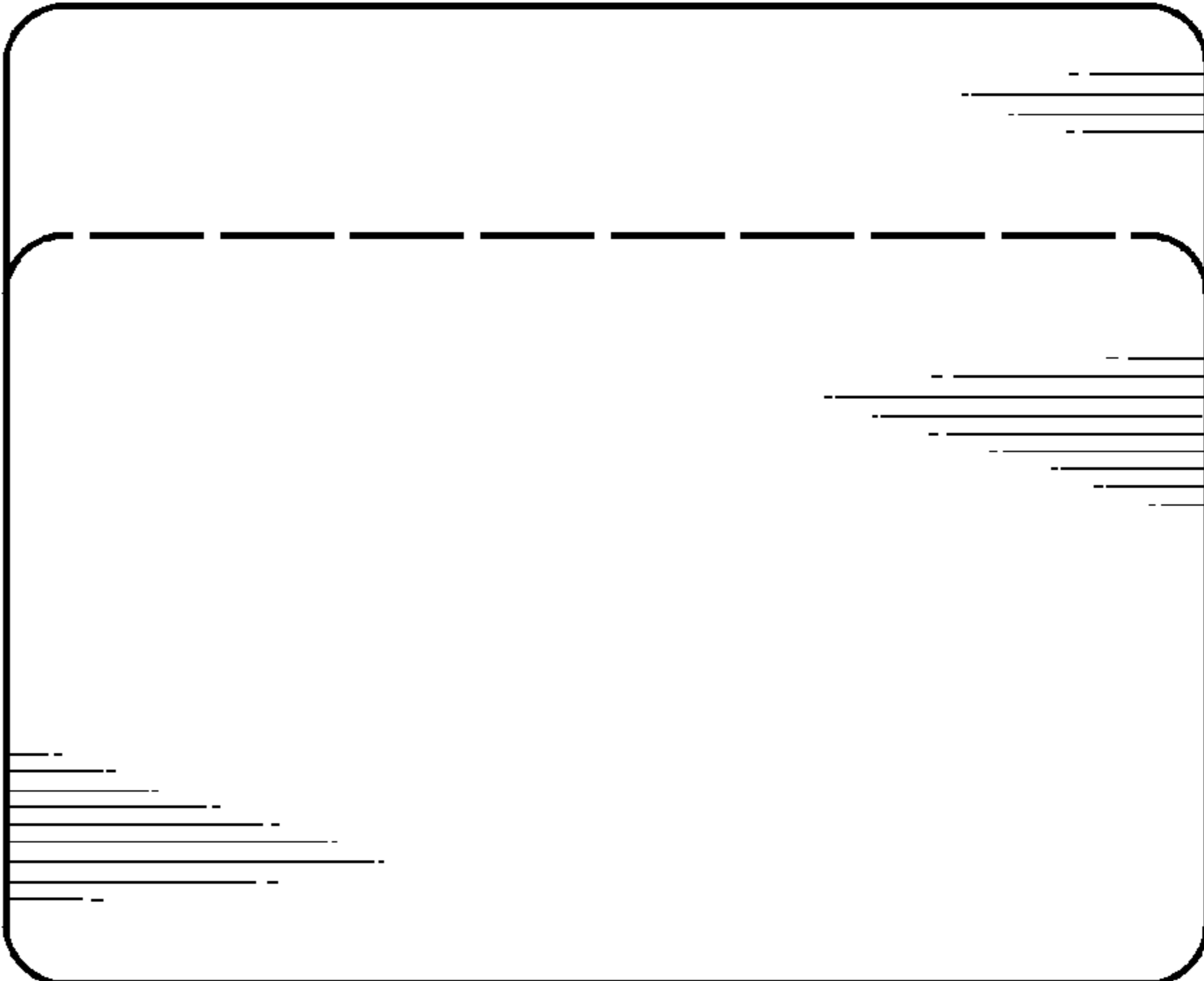

FIG. 2

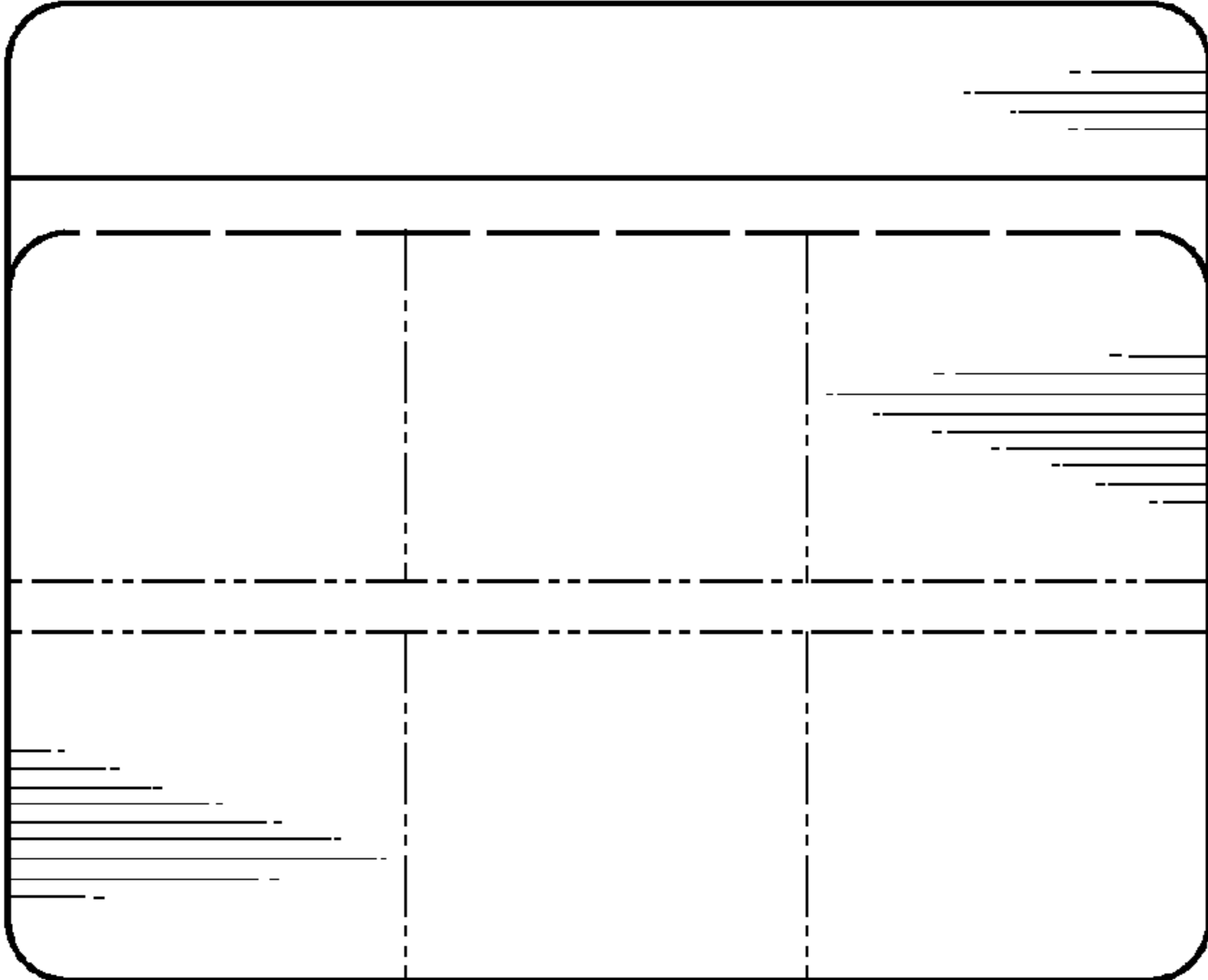

FIG. 3

FIG. 4



FIG. 5



FIG. 6

FIG. 7

FIG. 8

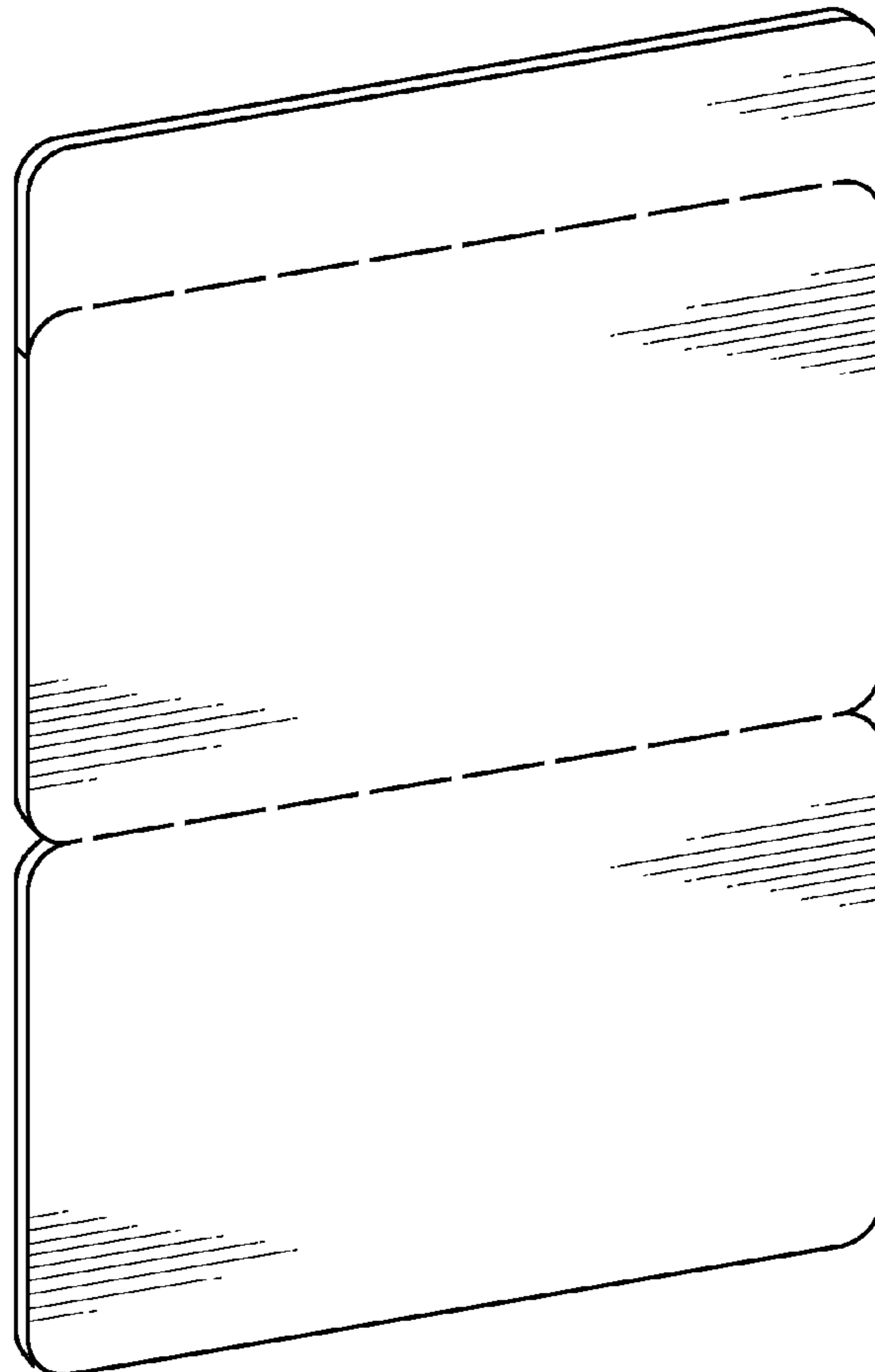

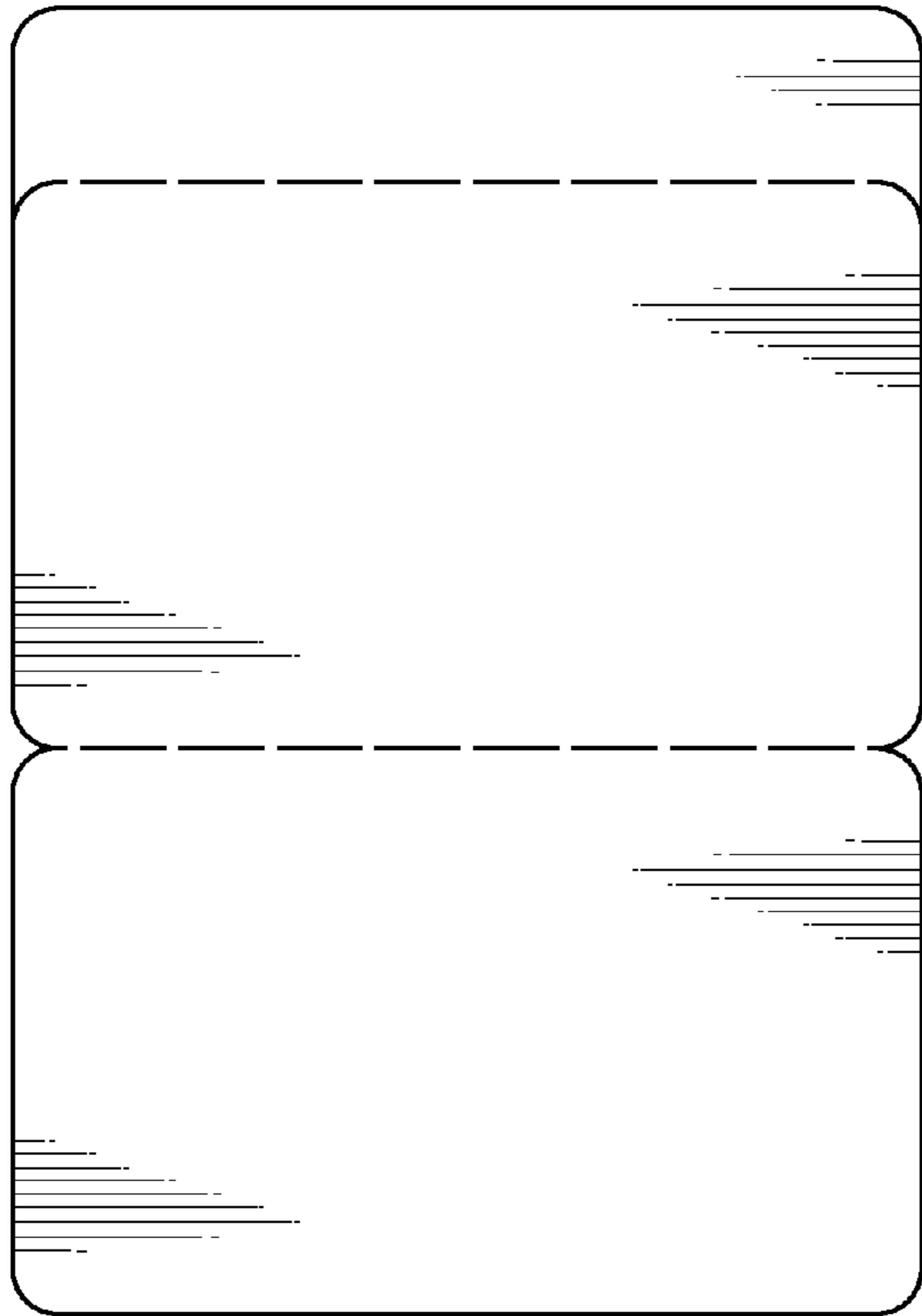

FIG. 9

FIG. 10

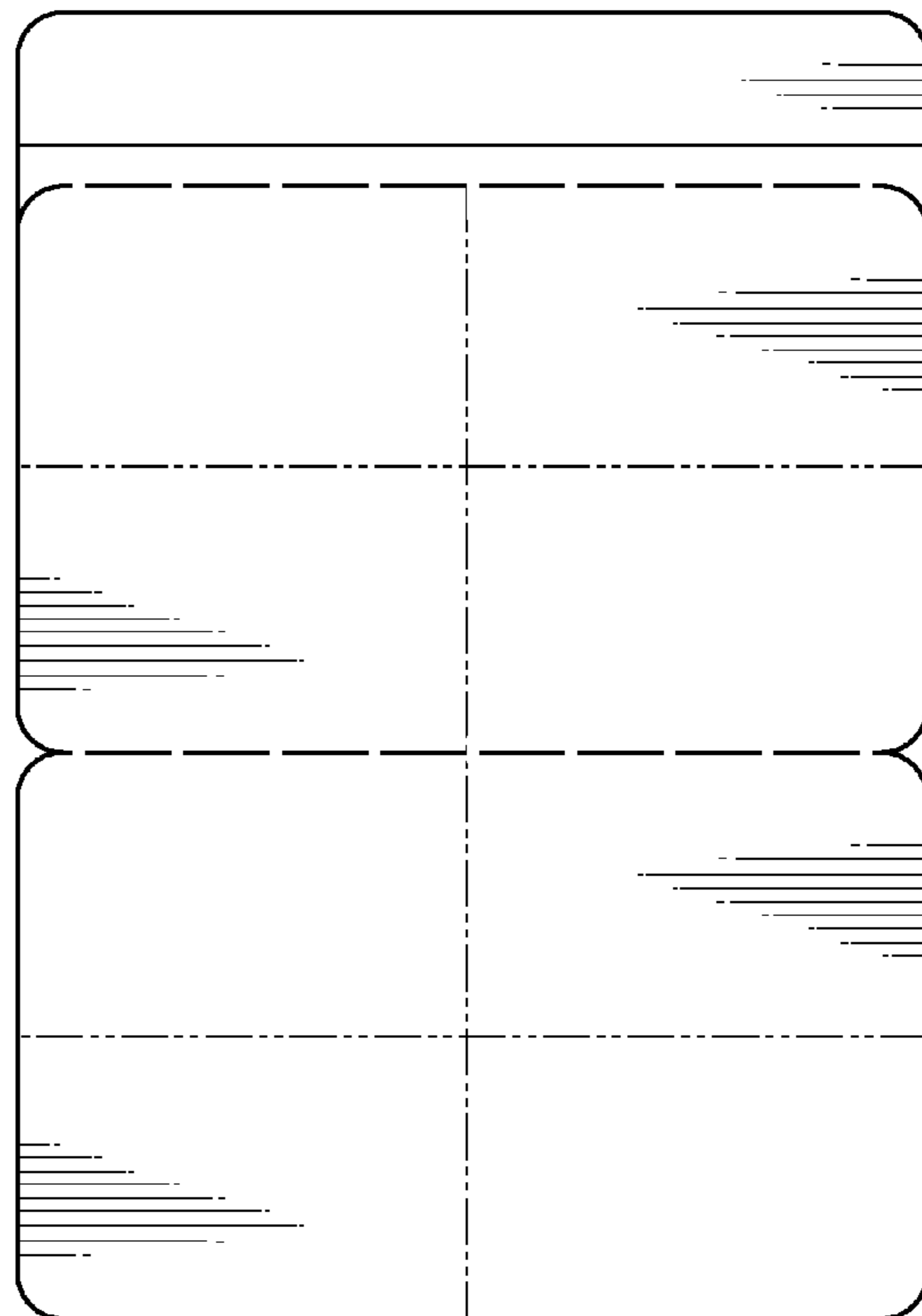



FIG. 11



FIG. 12



FIG. 13



FIG. 14

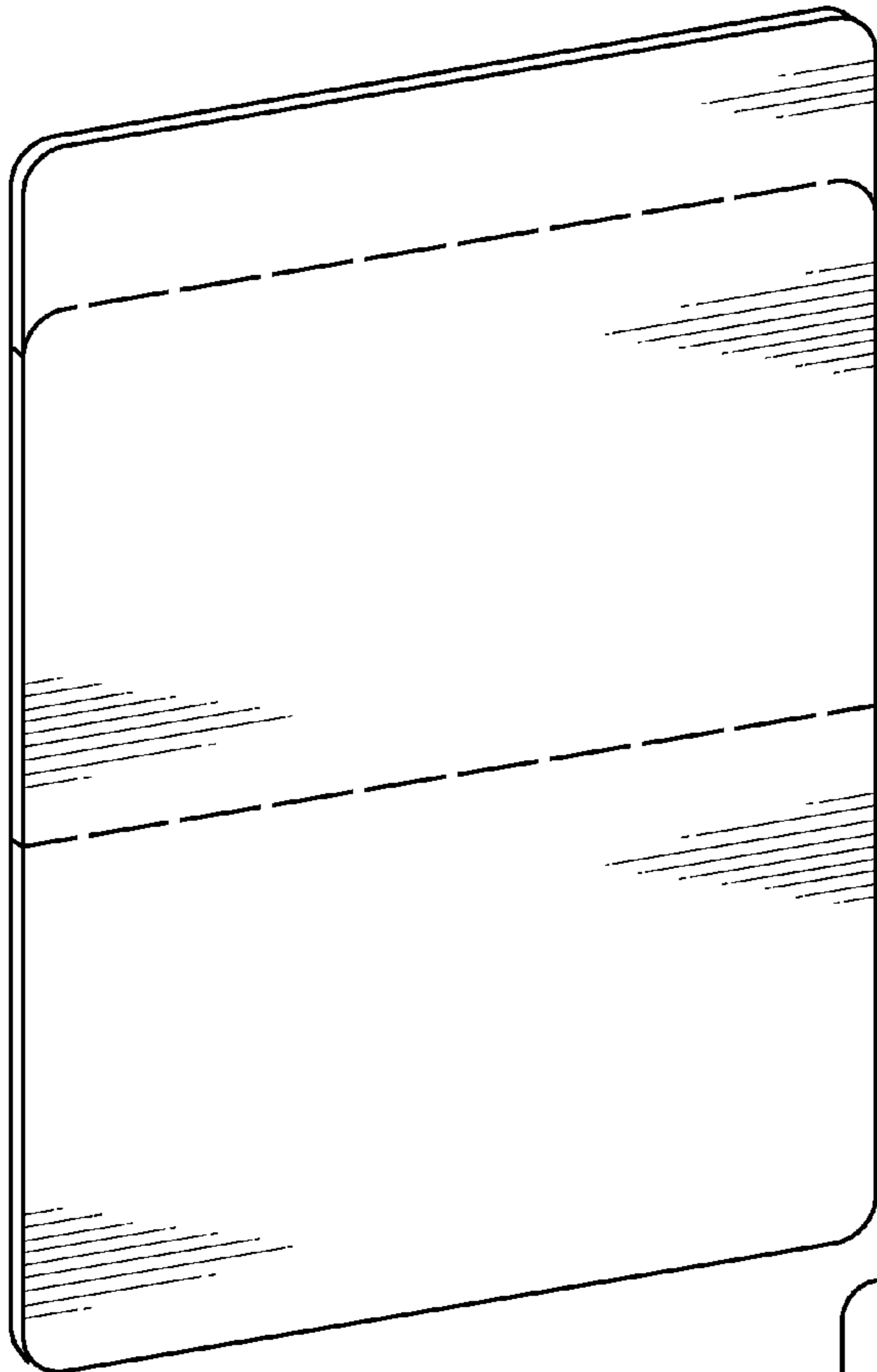

FIG. 15

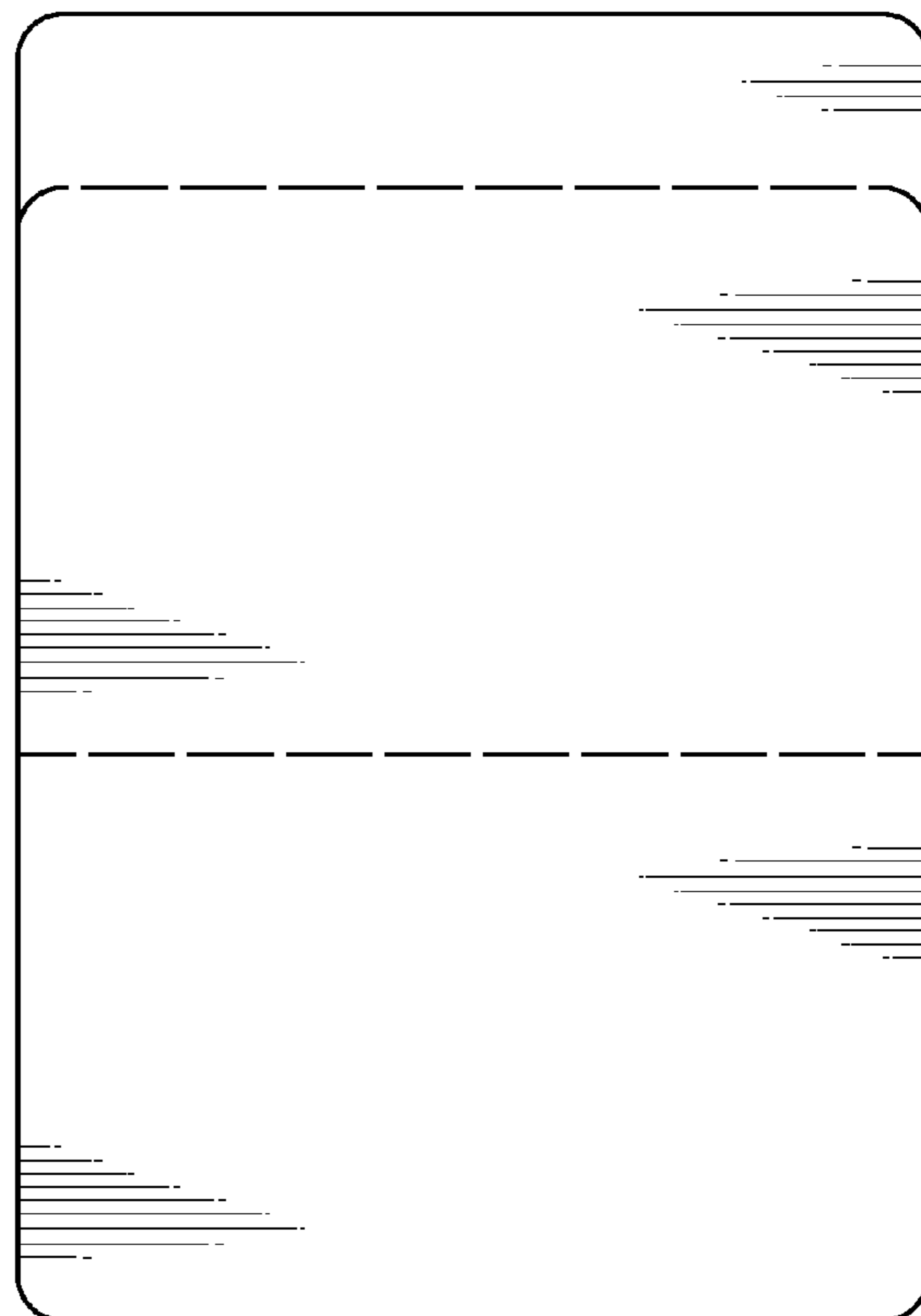

FIG. 16

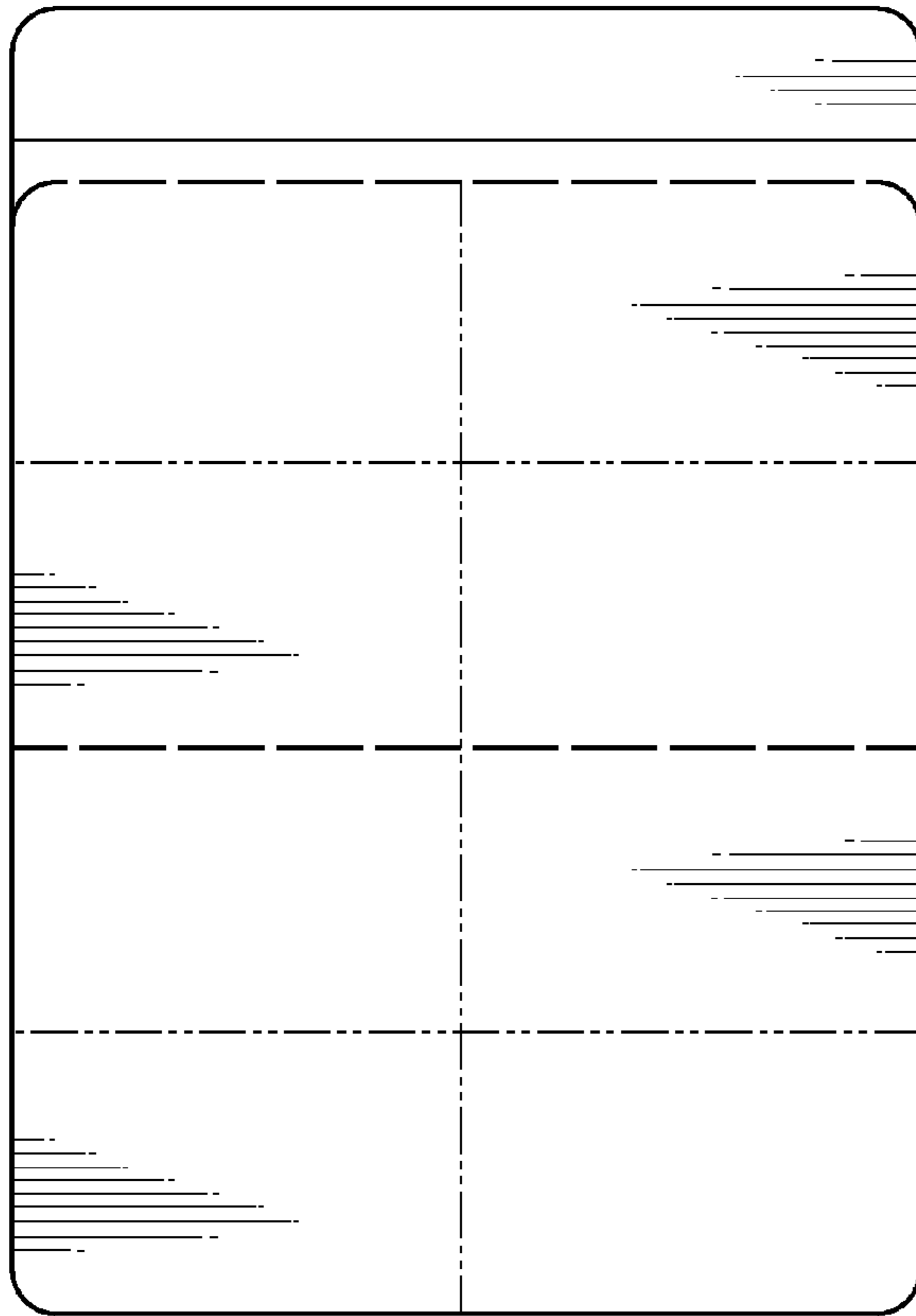

FIG. 17

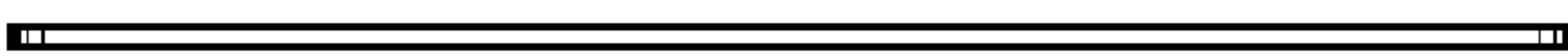

FIG. 18



FIG. 19

FIG. 20



FIG. 21

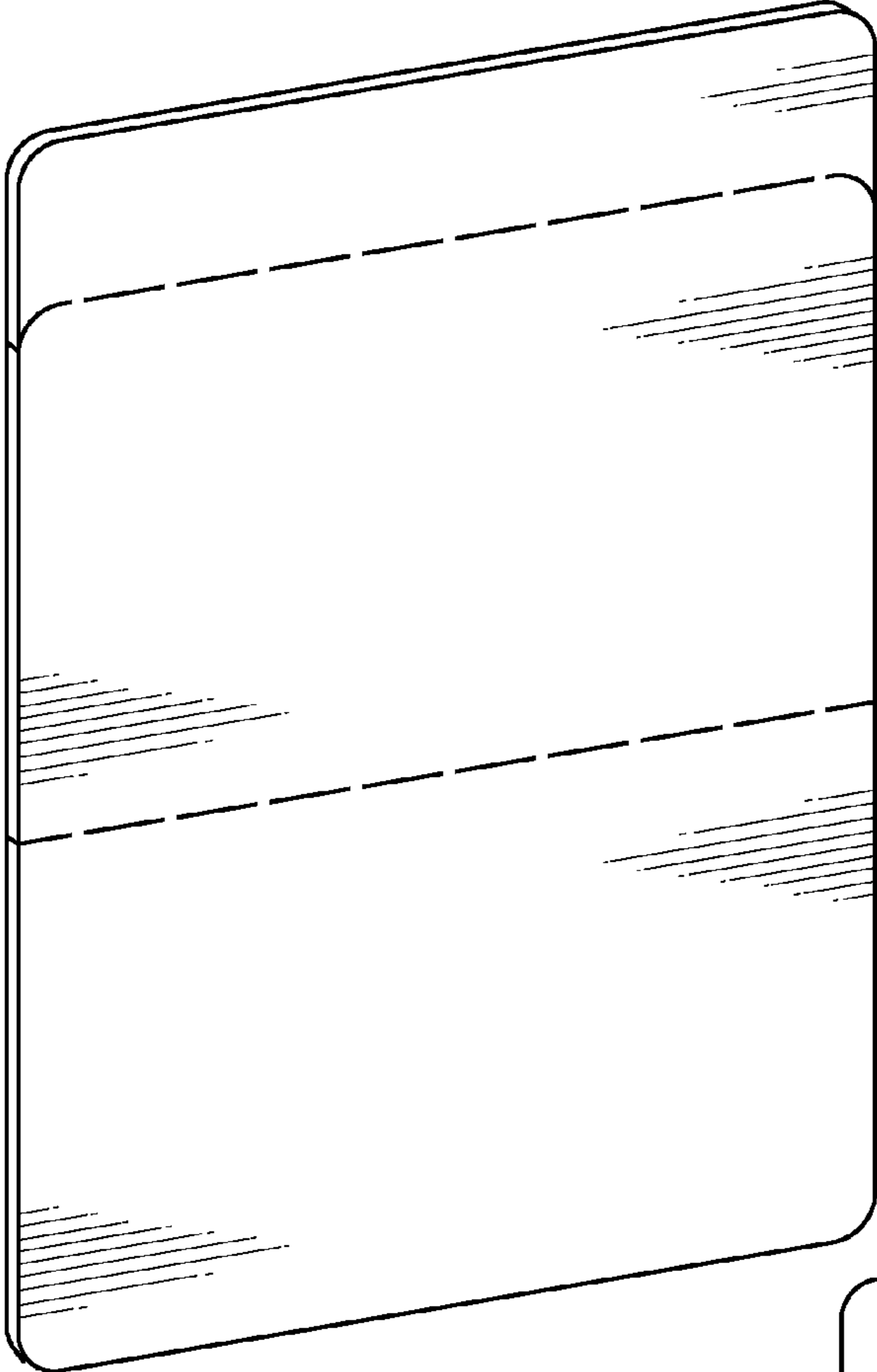

FIG. 22

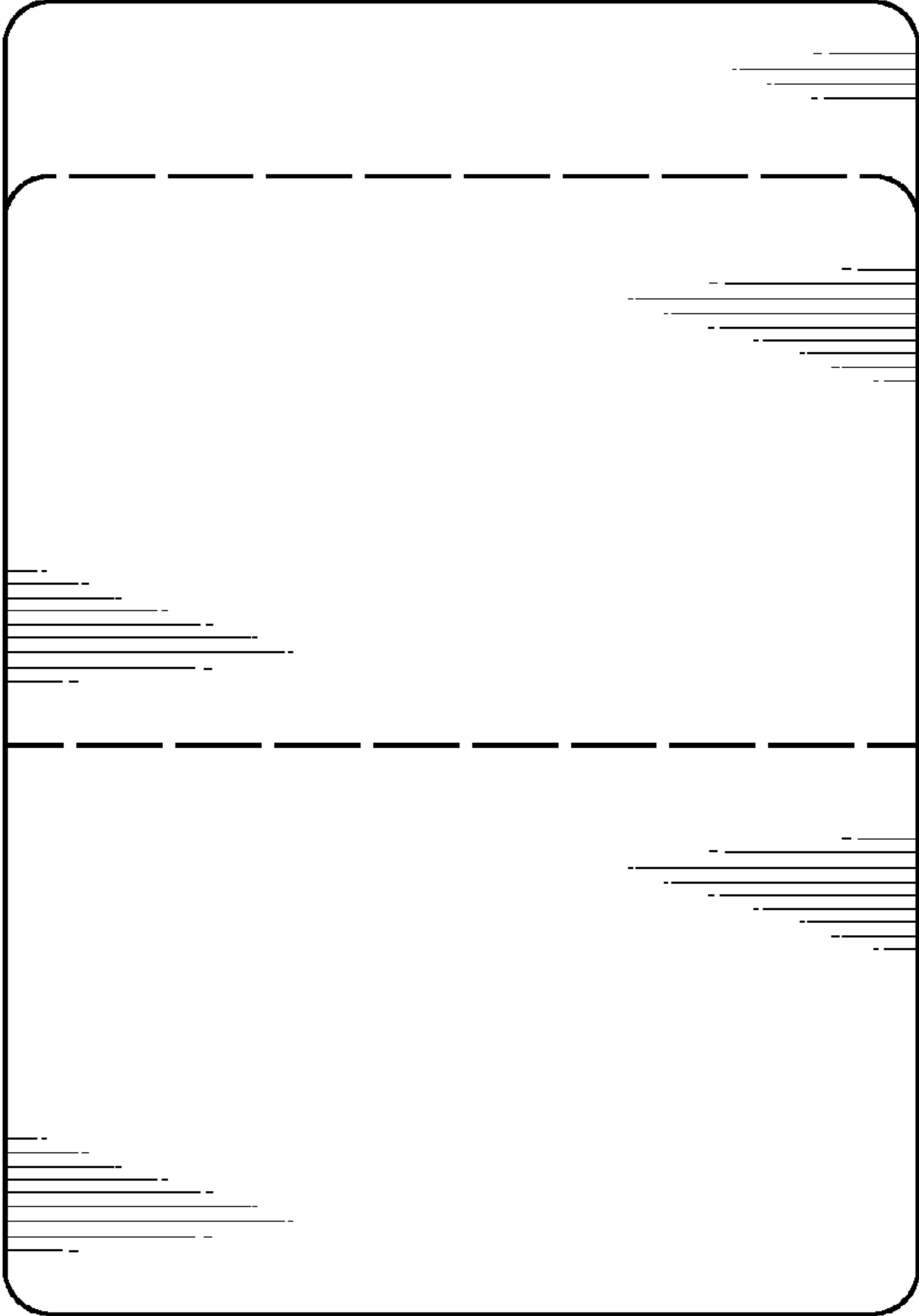

FIG. 23

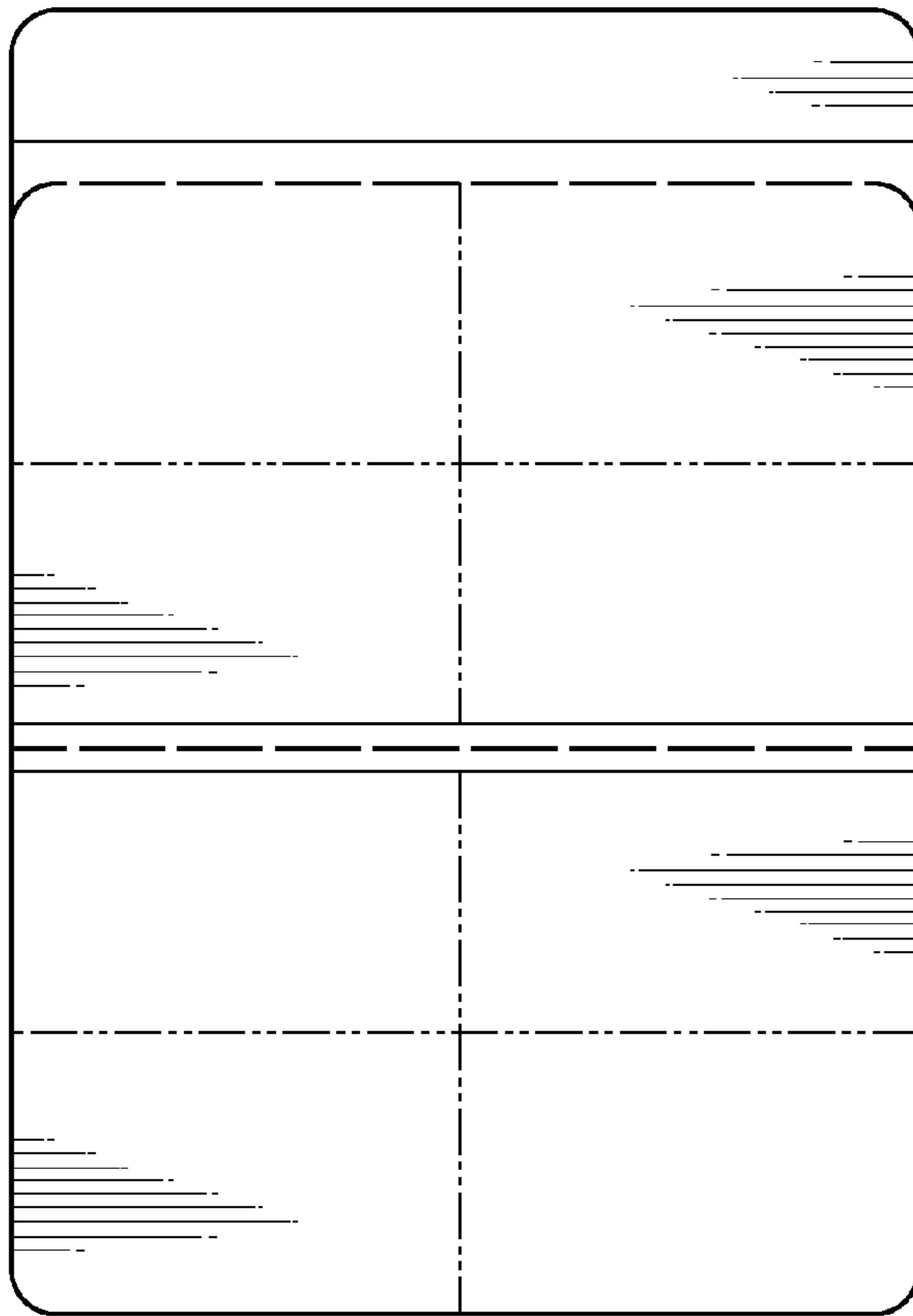

FIG. 24

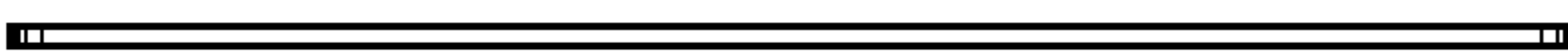

FIG. 25



FIG. 26

FIG. 27



FIG. 28