



US00D641574S

(12) **United States Design Patent**
Su

(10) **Patent No.:** **US D641,574 S**
(45) **Date of Patent:** **** Jul. 19, 2011**

(54) **CHAIR BACKREST**

(76) Inventor: **Tung-Hua Su**, Tainan Hsien (TW)

(**) Term: **14 Years**

(21) Appl. No.: **29/362,777**

(22) Filed: **May 29, 2010**

(51) **LOC (9) Cl.** **06-01**

(52) **U.S. Cl.** **D6/502**

(58) **Field of Classification Search** D6/334-336,
D6/364, 365, 366, 367, 369, 374, 476, 379,
D6/380, 500-502; 297/284.4, 284.7, 300.2,
297/452.18, 452.29, 452.3, 452.46, 452.64
See application file for complete search history.

(56) **References Cited**

U.S. PATENT DOCUMENTS

D540,579 S *	4/2007	Su	D6/502
D544,720 S *	6/2007	Berbegal Perez	D6/366
D553,886 S *	10/2007	Su	D6/502
D572,923 S *	7/2008	Huang	D6/366

D575,085 S *	8/2008	Su	D6/502
D575,969 S *	9/2008	Su	D6/502
D577,521 S *	9/2008	Su	D6/502
D580,689 S *	11/2008	Su	D6/502
7,604,299 B2 *	10/2009	Su	297/452.18

* cited by examiner

Primary Examiner — Mimoso De

(57) **CLAIM**

The ornamental design for a chair backrest, as shown and described.

DESCRIPTION

FIG. 1 is a perspective view of the chair backrest showing my new design;
FIG. 2 is a front elevation view thereof;
FIG. 3 is a rear elevation view thereof;
FIG. 4 is a left side elevation view thereof;
FIG. 5 is a right side elevation view thereof;
FIG. 6 is a top plan view thereof; and,
FIG. 7 is a bottom plan view thereof.

1 Claim, 6 Drawing Sheets

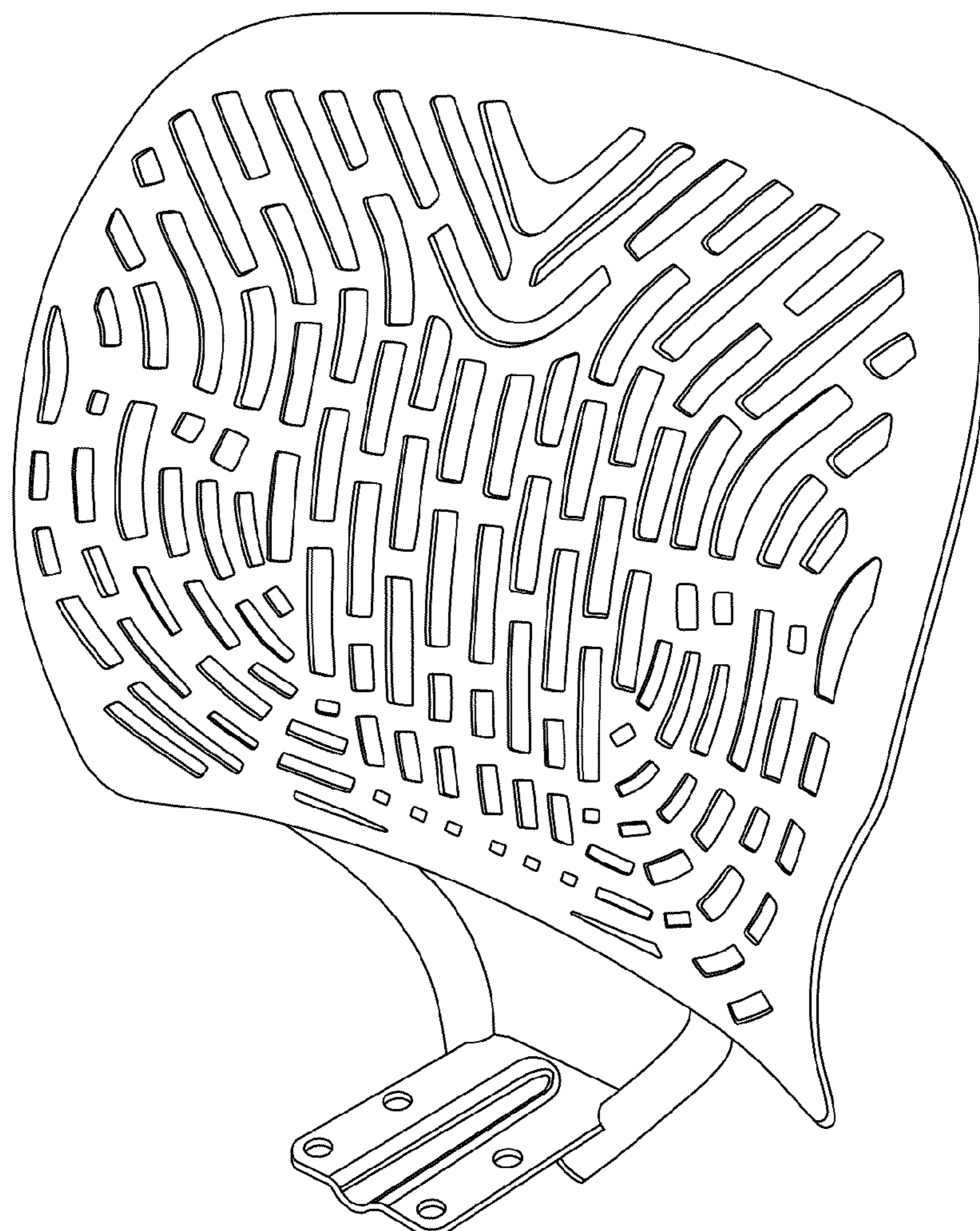

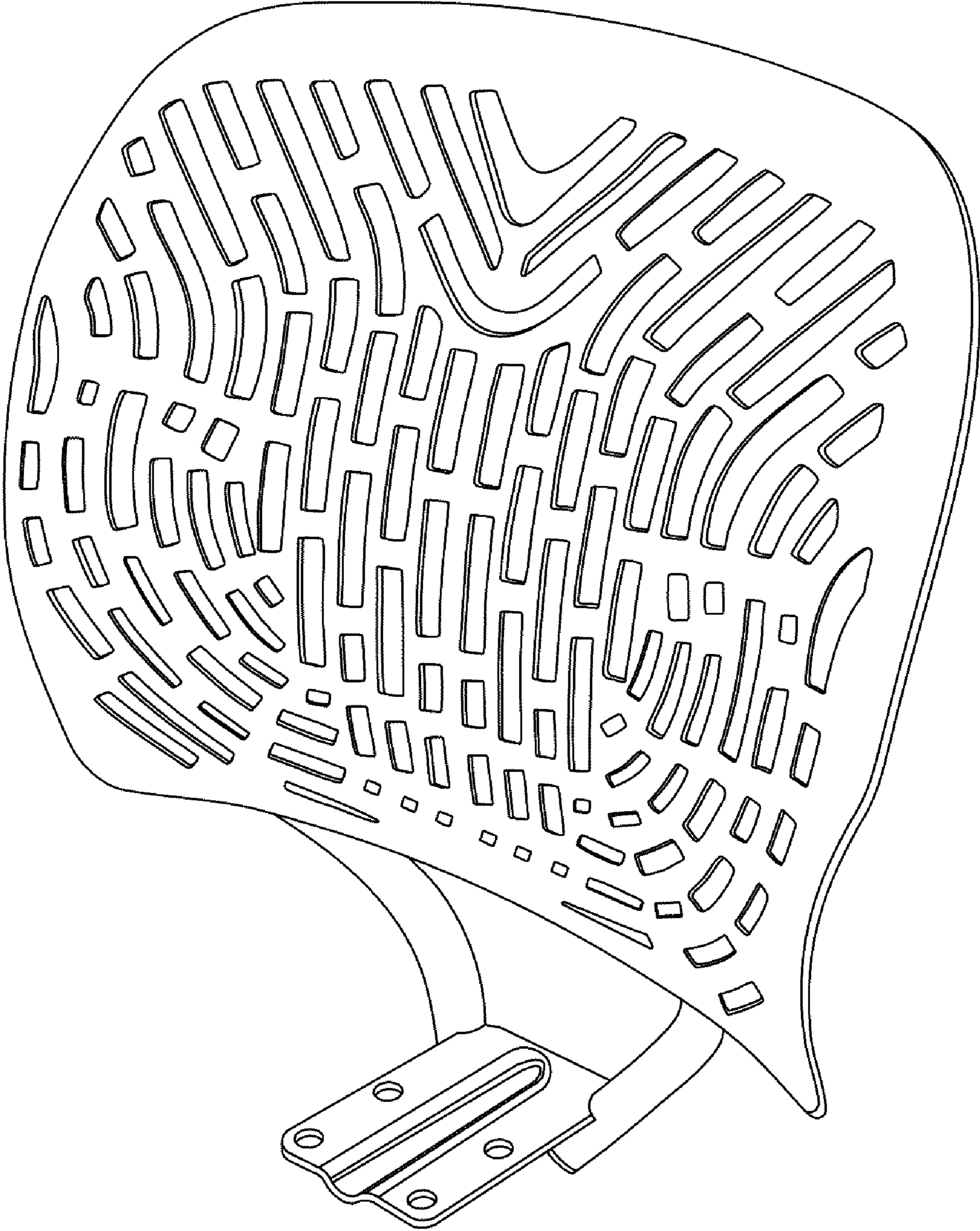

F I G . 1

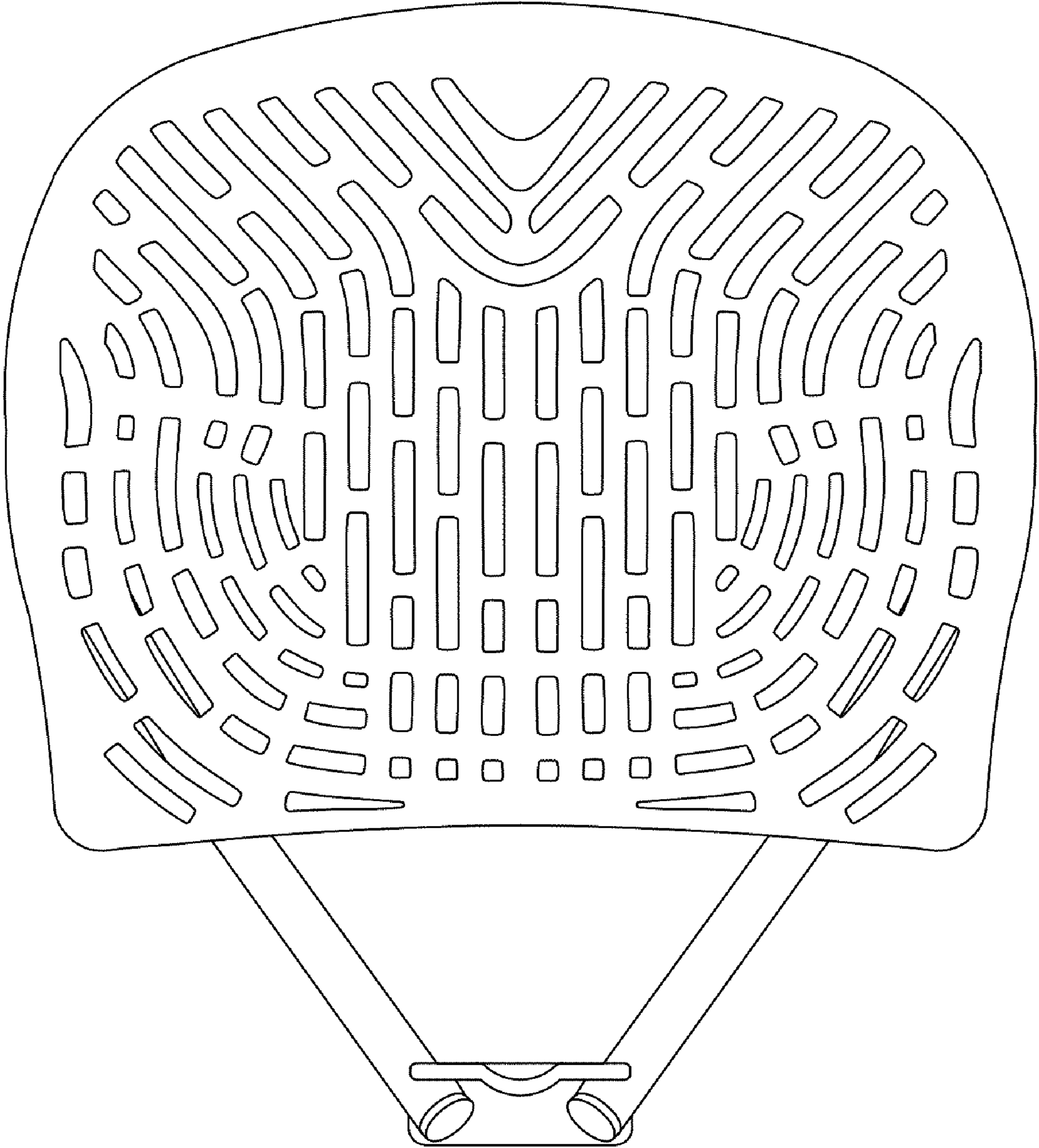

F I G . 2

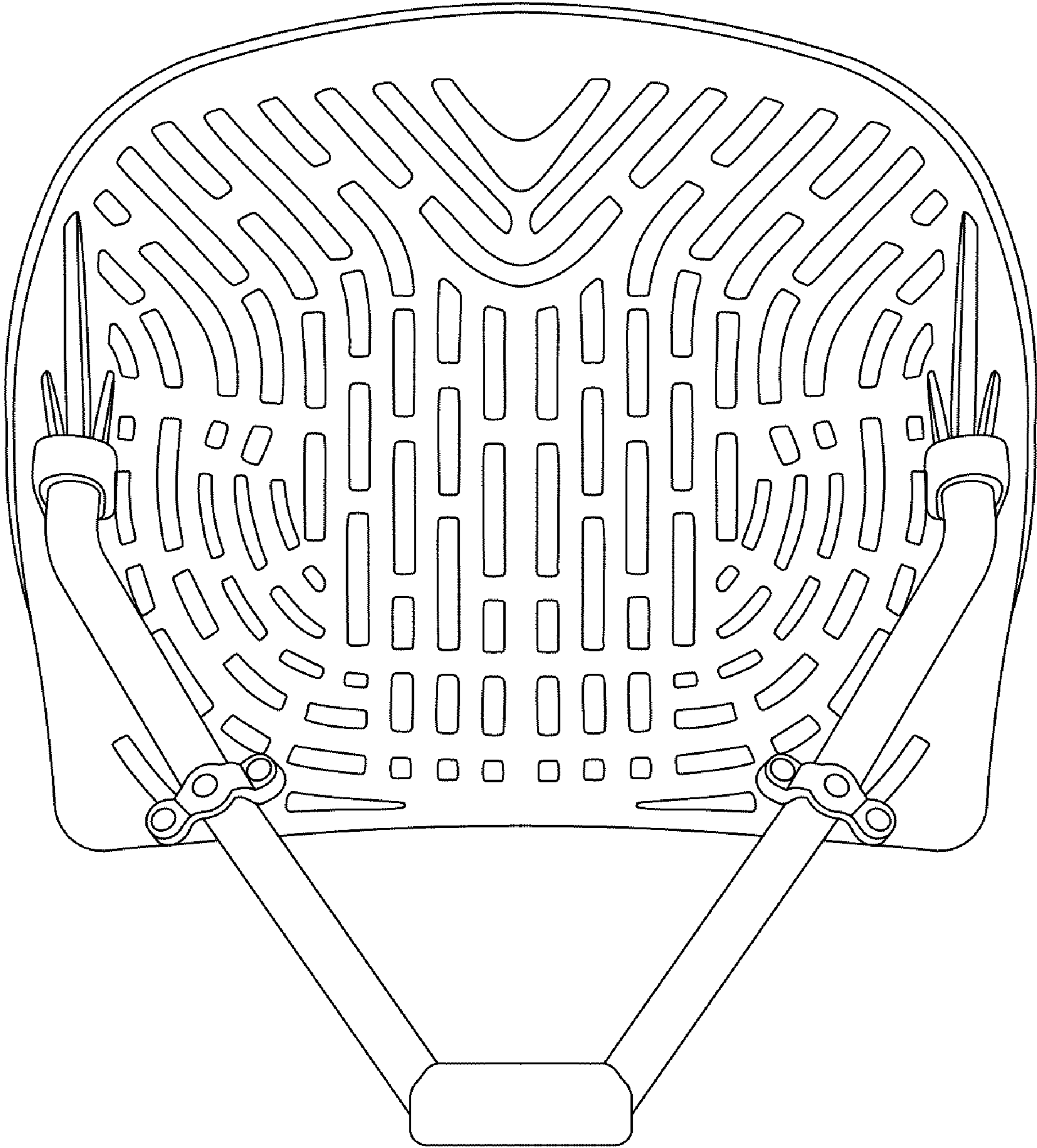

F I G . 3

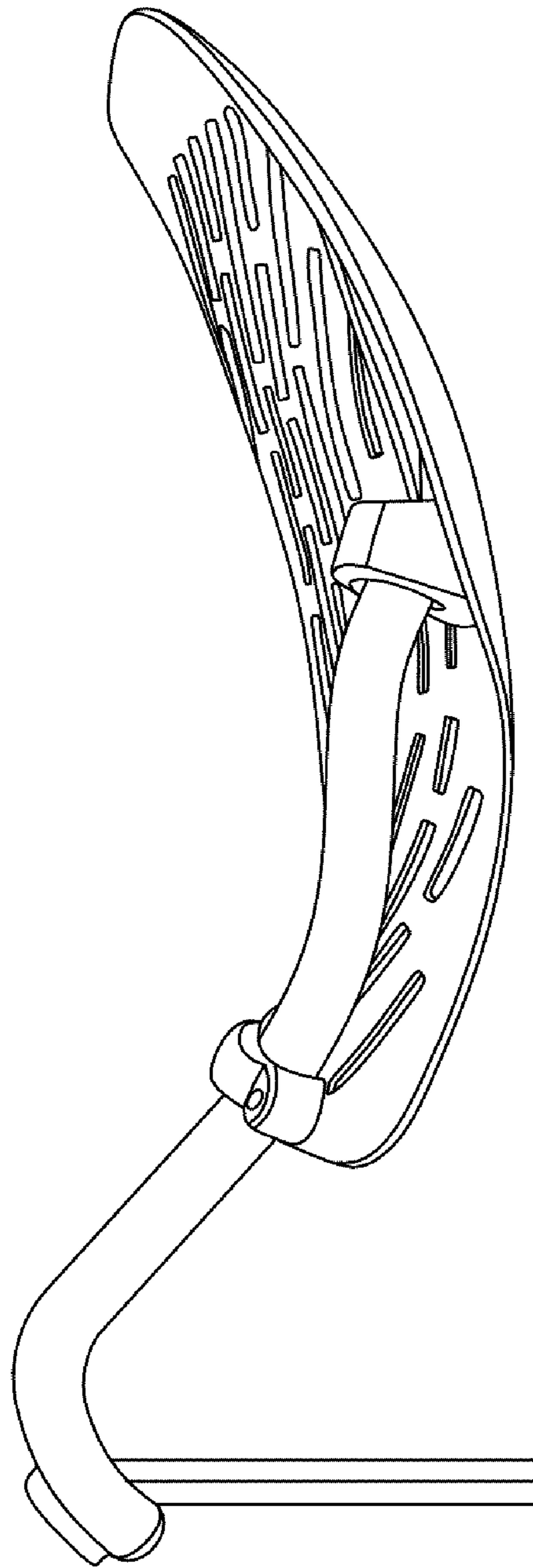

F I G . 4

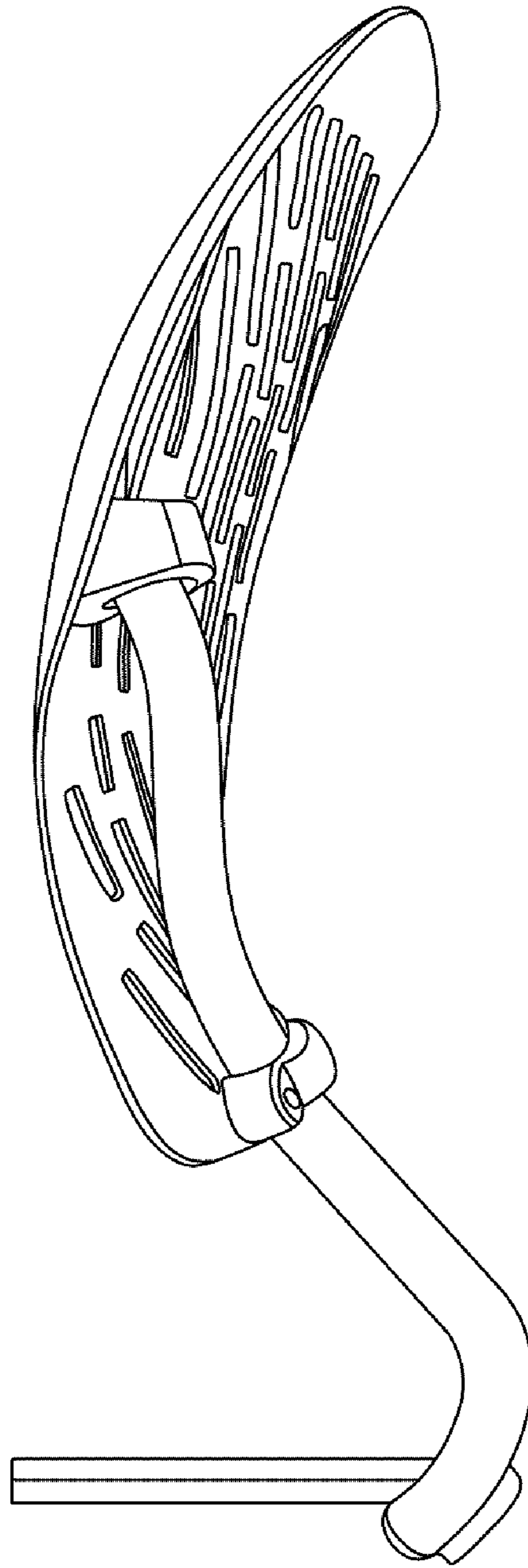
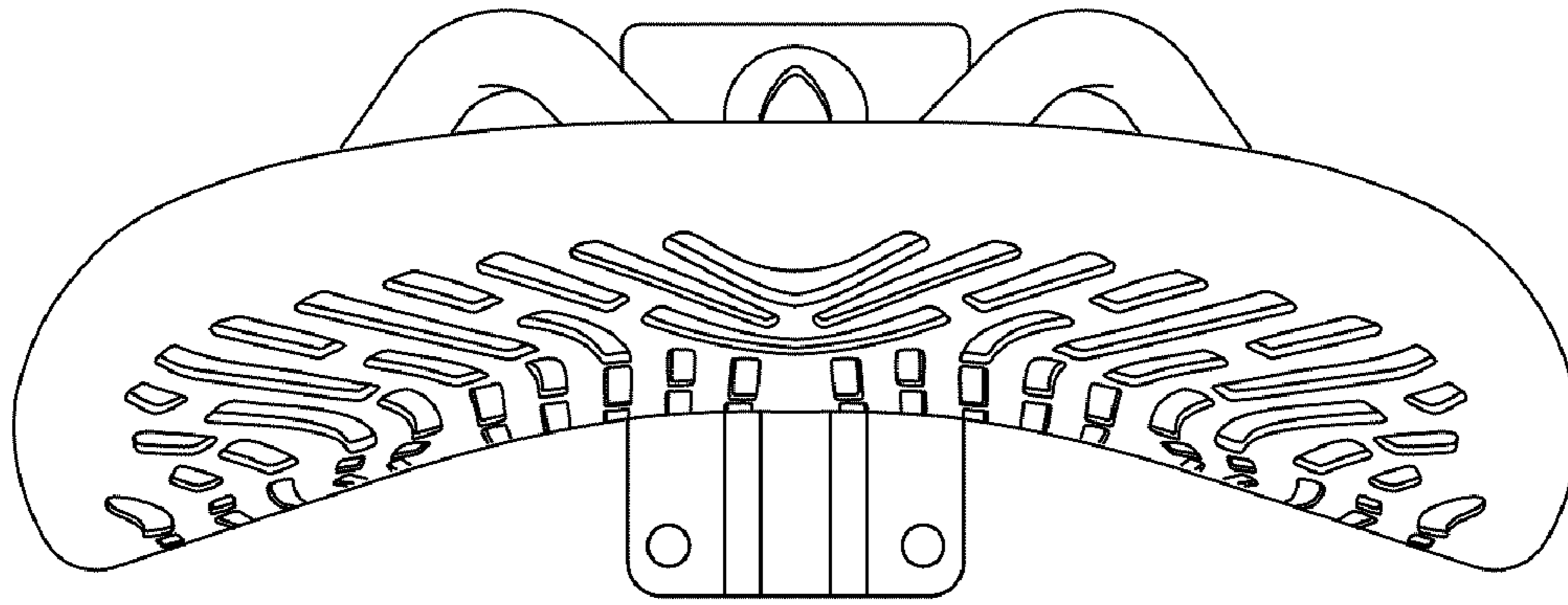
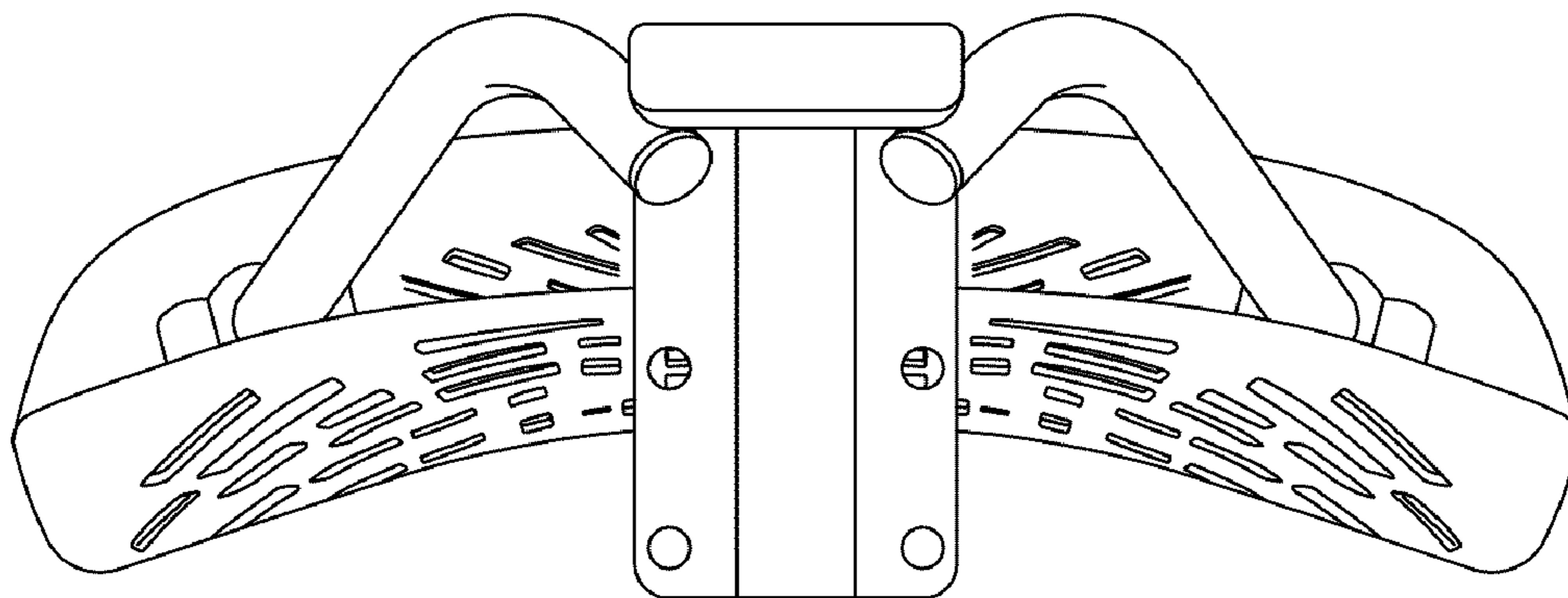

FIG. 5



F I G . 6



F I G . 7