



US00D641552S

(12) **United States Design Patent**  
**Sosnovsky**

(10) **Patent No.:** **US D641,552 S**  
(45) **Date of Patent:** **\*\* Jul. 19, 2011**

(54) **TOOL BAG**

(75) Inventor: **David Sosnovsky**, Tel Aviv (IL)

(73) Assignee: **The Stanley Works Israel Ltd.**, Rosh Ha' Ayin (IL)

(\*\*) Term: **14 Years**

(21) Appl. No.: **29/367,772**

(22) Filed: **Aug. 12, 2010**

(51) **LOC (9) Cl.** ..... **03-01**

(52) **U.S. Cl.** ..... **D3/283; D3/289**

(58) **Field of Classification Search** ..... D3/273,  
D3/276, 280, 283-293, 301, 246; 190/100,  
190/102, 106, 109-112, 115-117, 126; 206/278,  
206/372-379; 150/107-108, 110, 112, 115,  
150/118; 220/523, 527

See application file for complete search history.

(56) **References Cited**

**U.S. PATENT DOCUMENTS**

D447,632 S \* 9/2001 Gisser ..... D3/289  
D505,012 S \* 5/2005 Godshaw et al. .... D3/289  
6,915,902 B2 \* 7/2005 Brouard ..... 206/373

D525,430 S \* 7/2006 Suppancig ..... D3/289  
D610,795 S \* 3/2010 Dejadon ..... D3/283  
D610,808 S \* 3/2010 Kaddar ..... D3/276  
D628,384 S \* 12/2010 McCarthy ..... D3/289  
2005/0029066 A1 \* 2/2005 Redzisz ..... 190/111  
2007/0102253 A1 \* 5/2007 Godshaw et al. .... 190/102  
2007/0137960 A1 \* 6/2007 Redzisz ..... 190/111

\* cited by examiner

*Primary Examiner* — Jennifer Rivard

(74) *Attorney, Agent, or Firm* — Pillsbury Winthrop Shaw Pittman LLP

(57) **CLAIM**

The ornamental design for a tool bag, as shown and described.

**DESCRIPTION**

FIG. 1 is an isometric view according to my design;  
FIG. 2 is a front elevation view of the design of FIG. 1;  
FIG. 3 is a rear elevation view of the design of FIG. 1;  
FIG. 4 is a left side elevation view of the design of FIG. 1;  
FIG. 5 is a right side elevation view of the design of FIG. 1;  
FIG. 6 is a top plan view of the design of FIG. 1; and,  
FIG. 7 is a bottom plan view of the design of FIG. 1.

**1 Claim, 7 Drawing Sheets**



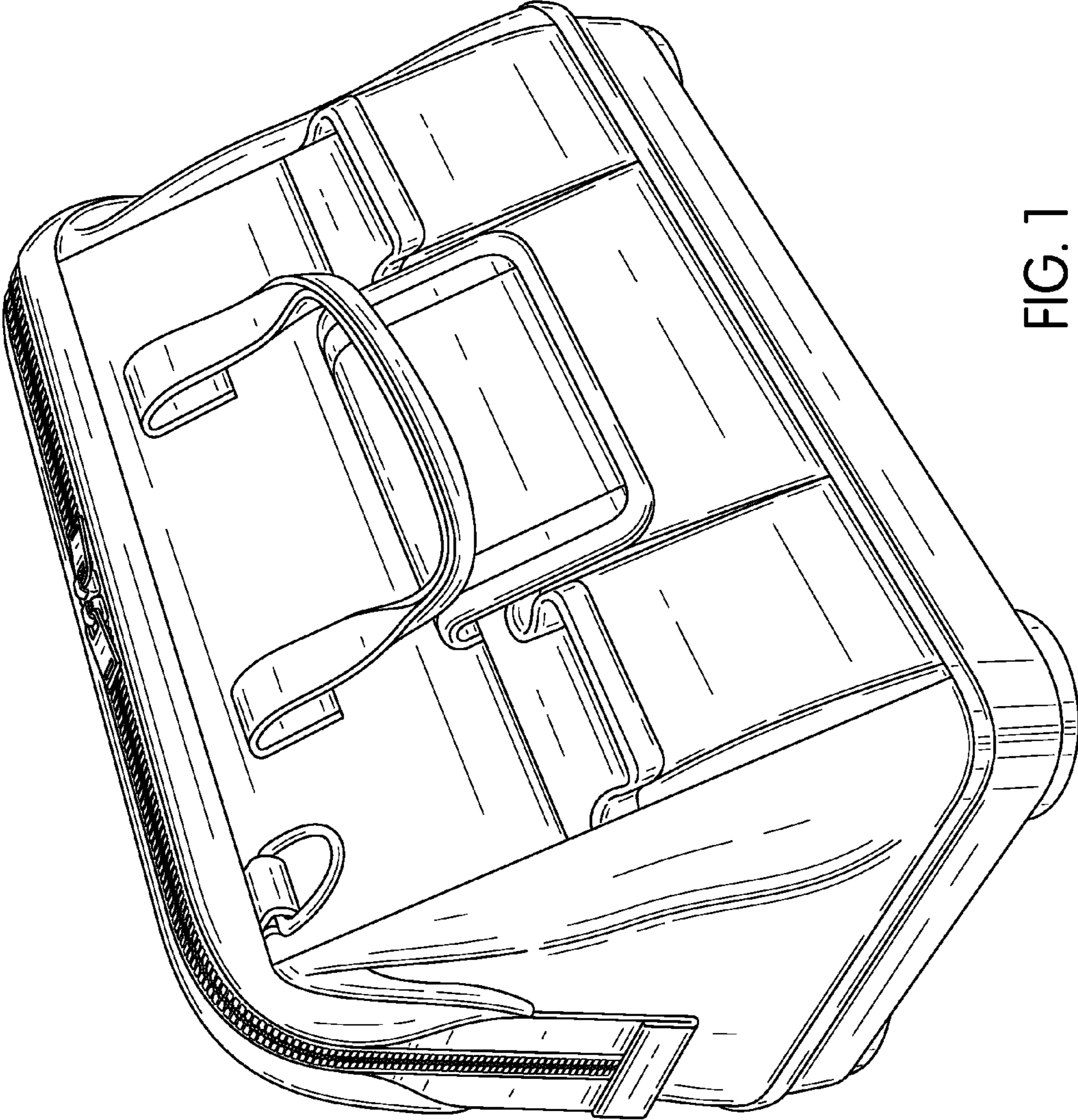

FIG. 1

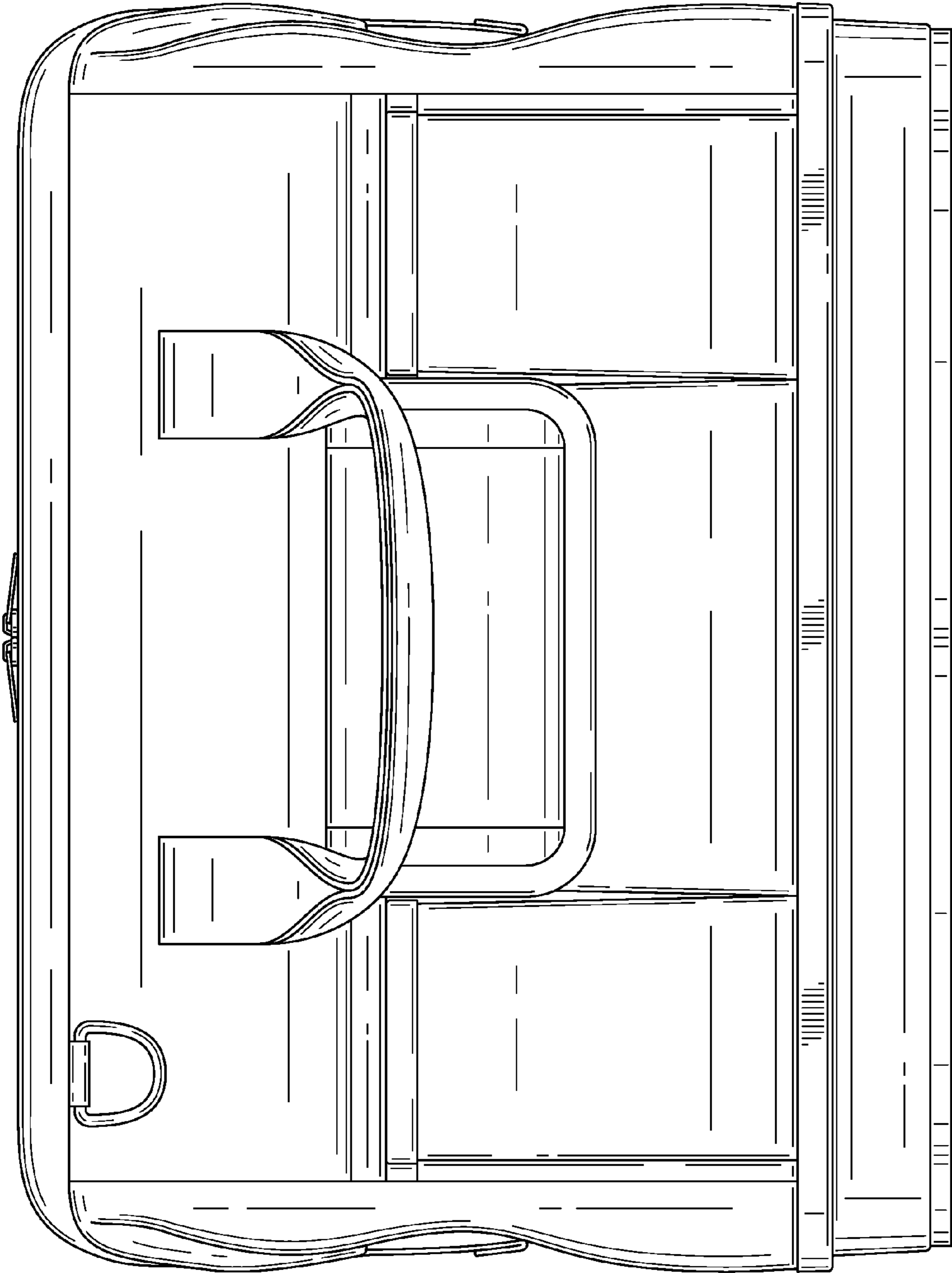

FIG. 2

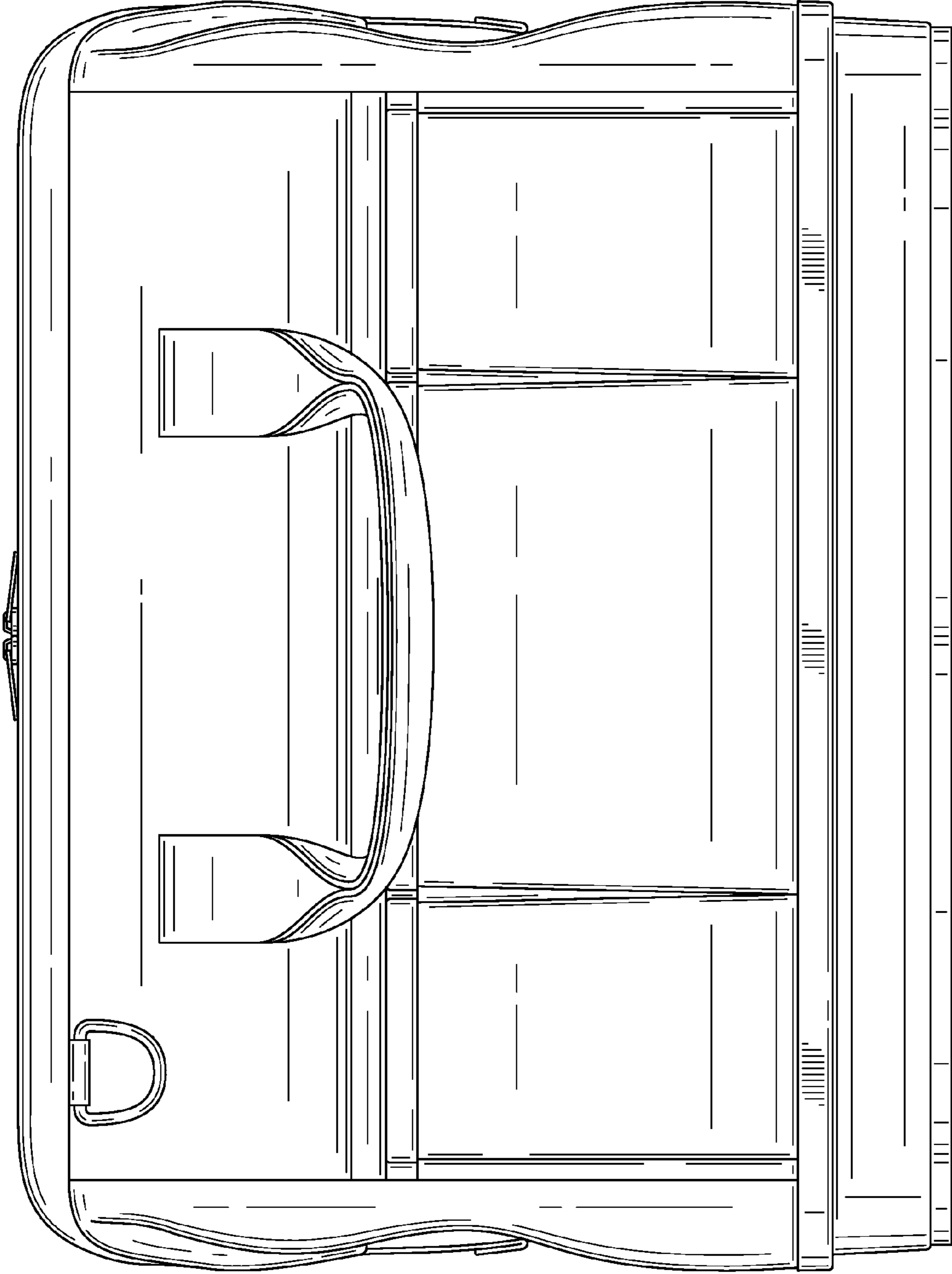

FIG. 3

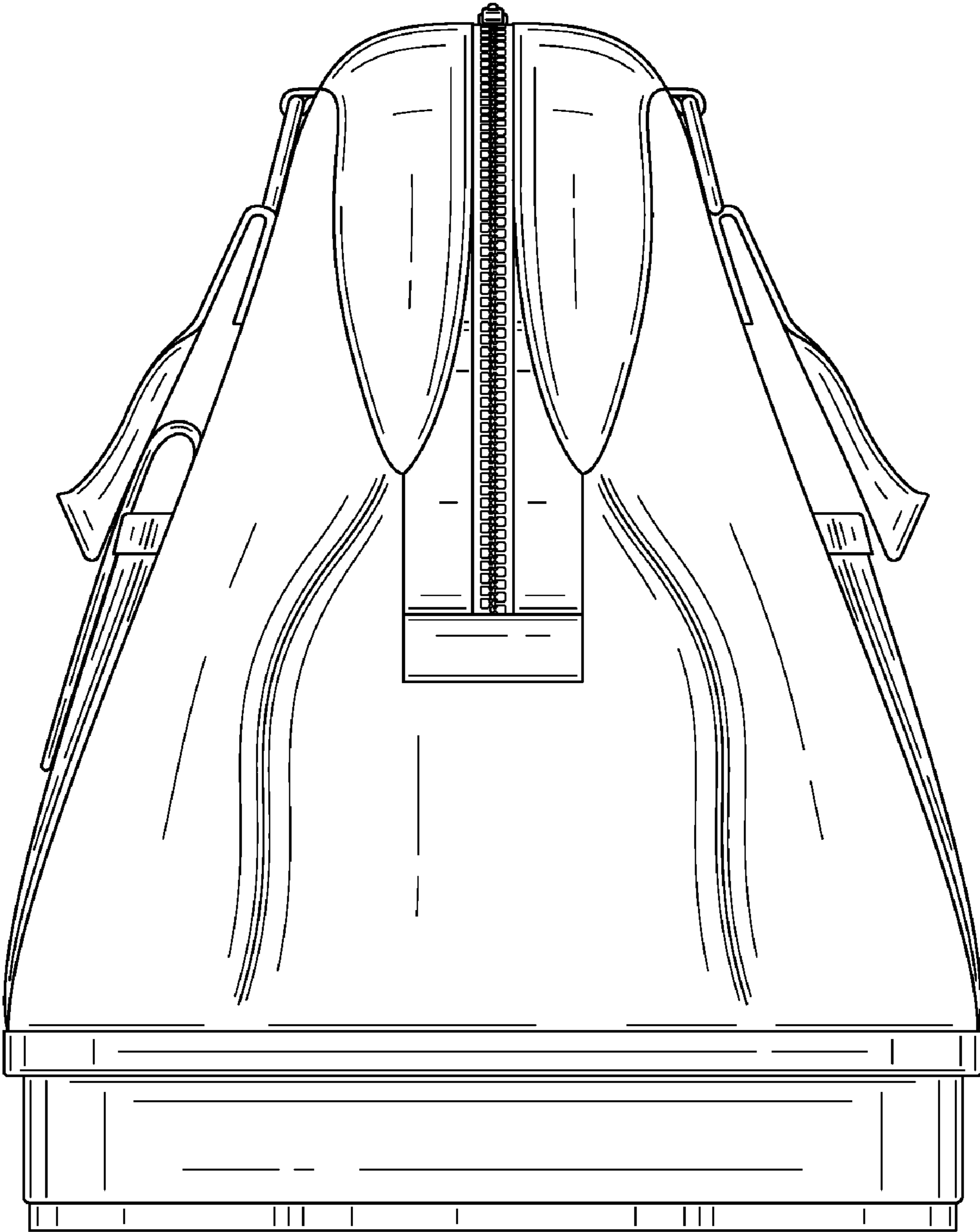

FIG. 4

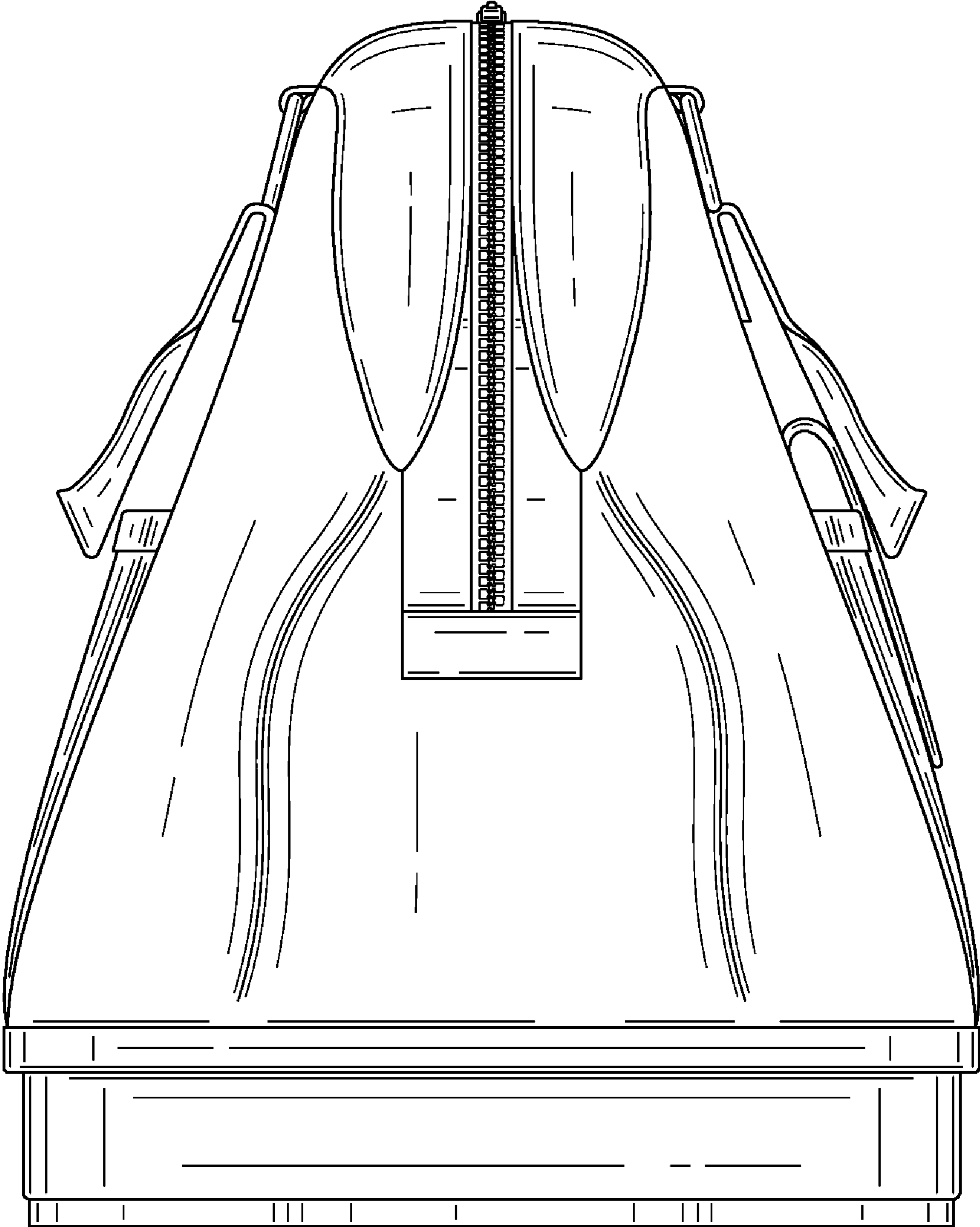

FIG. 5

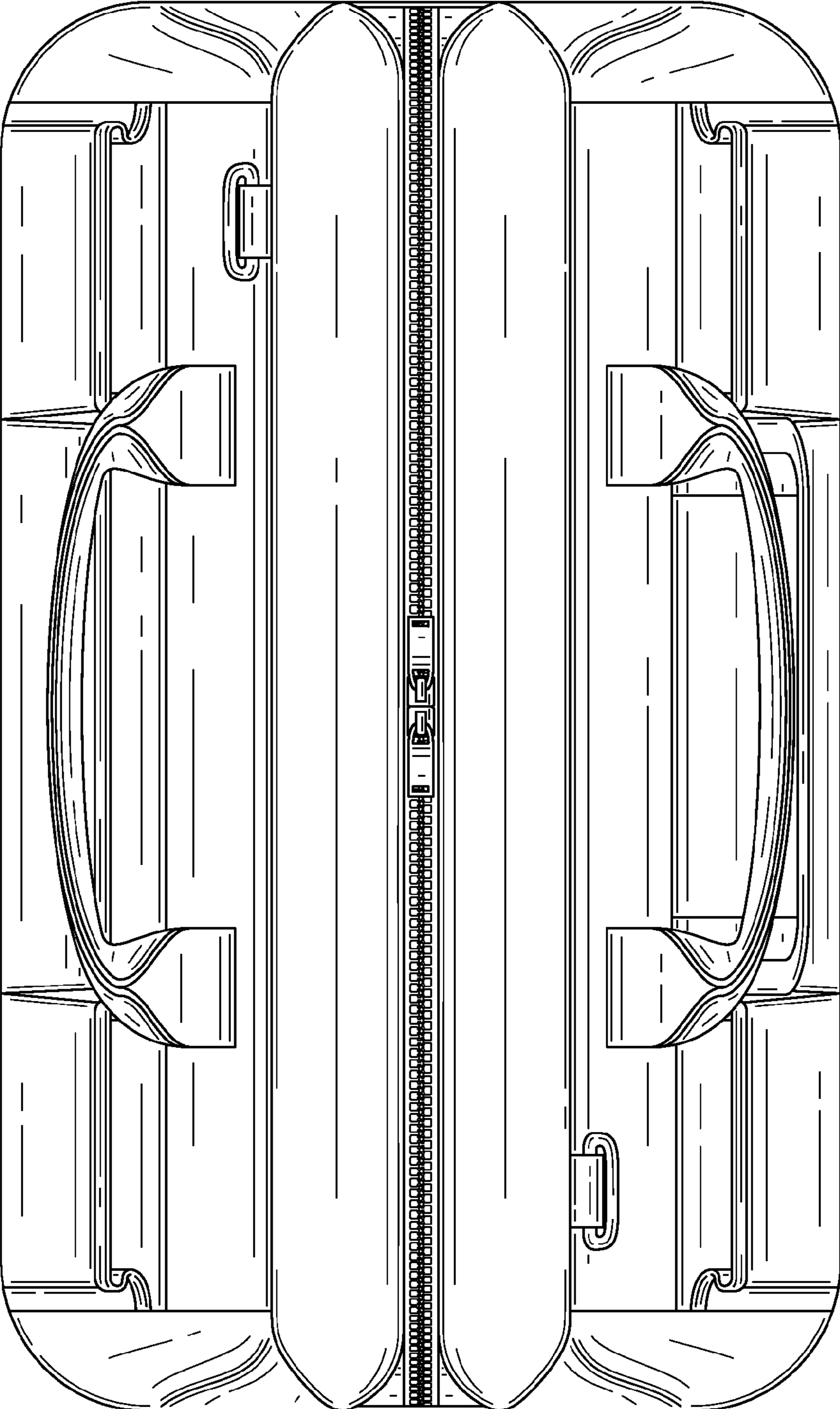

FIG. 6

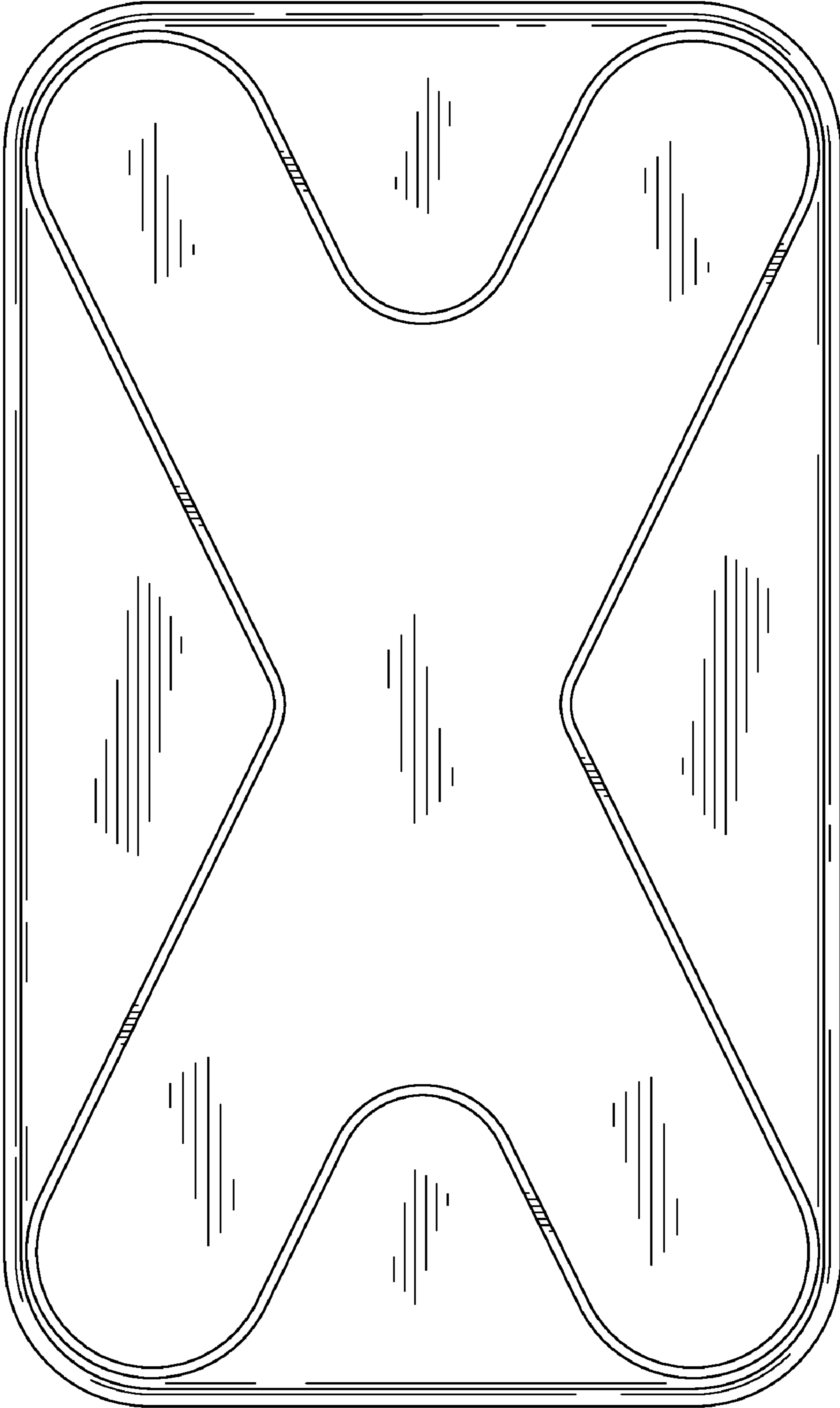

FIG. 7