

US00D641505S

(12) **United States Design Patent**
Futschik et al.

(10) **Patent No.:** **US D641,505 S**

(45) **Date of Patent:** **** Jul. 12, 2011**

(54) **FRONT LIGHT ASSEMBLY FOR A VEHICLE**

(75) Inventors: **Hans-Dieter Futschik**, Gechingen (DE);
Stefan Handt, Stuttgart (DE); **Steffen Koehl**, Stuttgart (DE); **Frank Pfisterer**, Weil der Stadt (DE)

(73) Assignee: **Daimler AG**, Stuttgart (DE)

(**) Term: **14 Years**

(21) Appl. No.: **29/360,570**

(22) Filed: **Apr. 28, 2010**

Related U.S. Application Data

(62) Division of application No. 29/300,896, filed on May 27, 2008, now Pat. No. Des. 623,782.

(30) **Foreign Application Priority Data**

Nov. 28, 2007 (DE) 40705900

(51) **LOC (9) Cl.** **26-06**

(52) **U.S. Cl.** **D26/28**

(58) **Field of Classification Search** D26/28-36;
362/459-468, 475-478, 485-487

See application file for complete search history.

(56) **References Cited**

U.S. PATENT DOCUMENTS

D537,021 S	2/2007	Pfeiffer	
D544,404 S	6/2007	Pfeiffer	
D550,380 S *	9/2007	Lin	D26/28
D561,359 S *	2/2008	Hsu	D26/28
D563,576 S *	3/2008	Hanaoka	D26/28
D573,282 S	7/2008	Hsu	
D623,782 S *	9/2010	Futschik et al.	D26/28
D627,906 S *	11/2010	Varga	D26/28

* cited by examiner

Primary Examiner — Marcus Jackson

(74) *Attorney, Agent, or Firm* — Crowell & Moring LLP

(57) **CLAIM**

The ornamental design for a front light assembly for a vehicle, as shown and described.

DESCRIPTION

FIG. 1 is a front view of a first embodiment of a front light assembly for a vehicle according to our novel design;

FIG. 2 is a left perspective view thereof; and

FIG. 3 is a right perspective view thereof.

FIG. 4 is a right side front perspective view thereof according to my design, with the front light assembly for a vehicle for the opposite side of the vehicle being depicted in the FIGS. 1 to 3;

FIG. 5 is a right perspective view thereof; and,

FIG. 6 is a left perspective view thereof.

The broken lines are for illustrative purposes only and form no part of the claimed design.

1 Claim, 6 Drawing Sheets

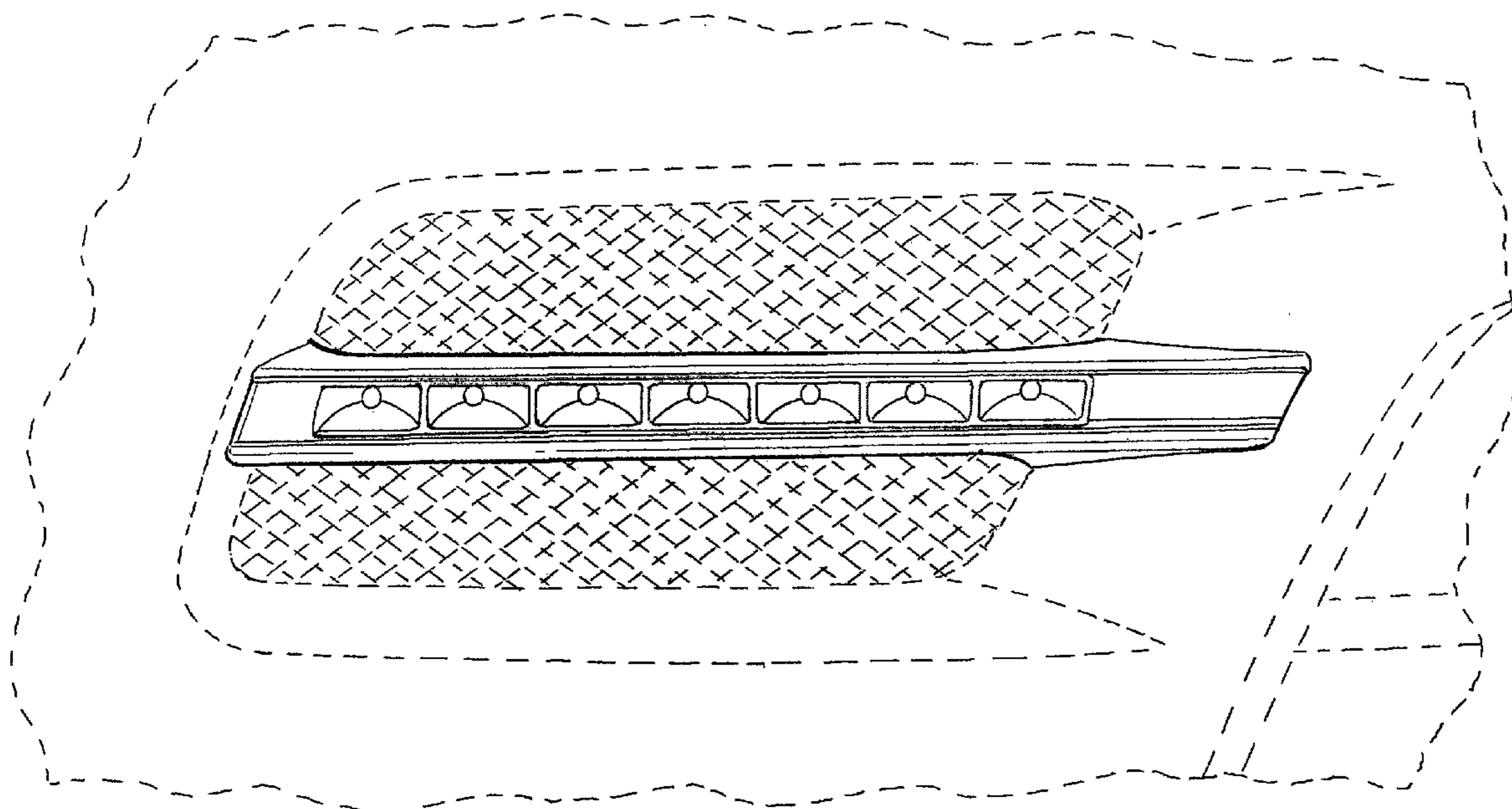

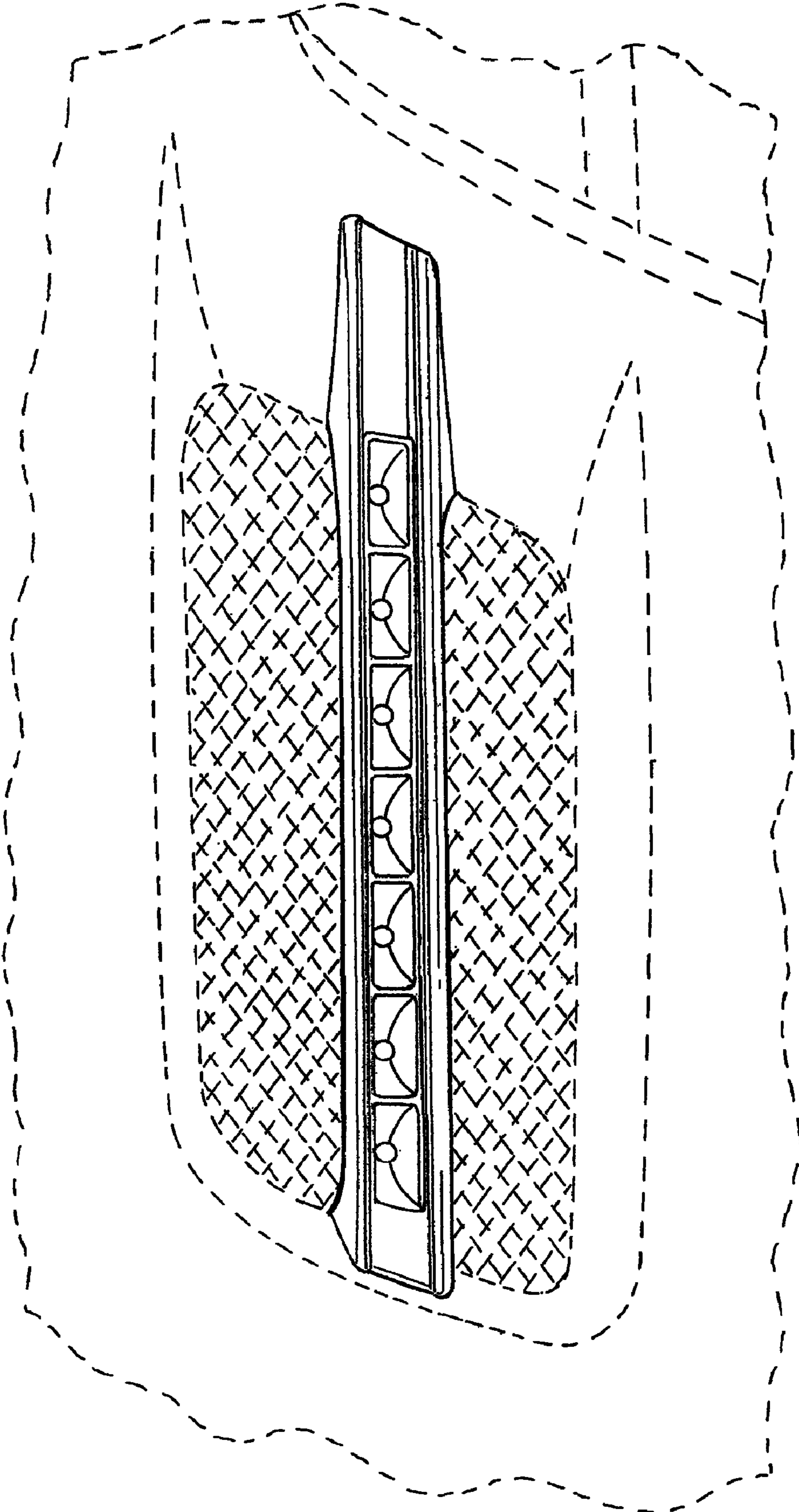

FIG. 1

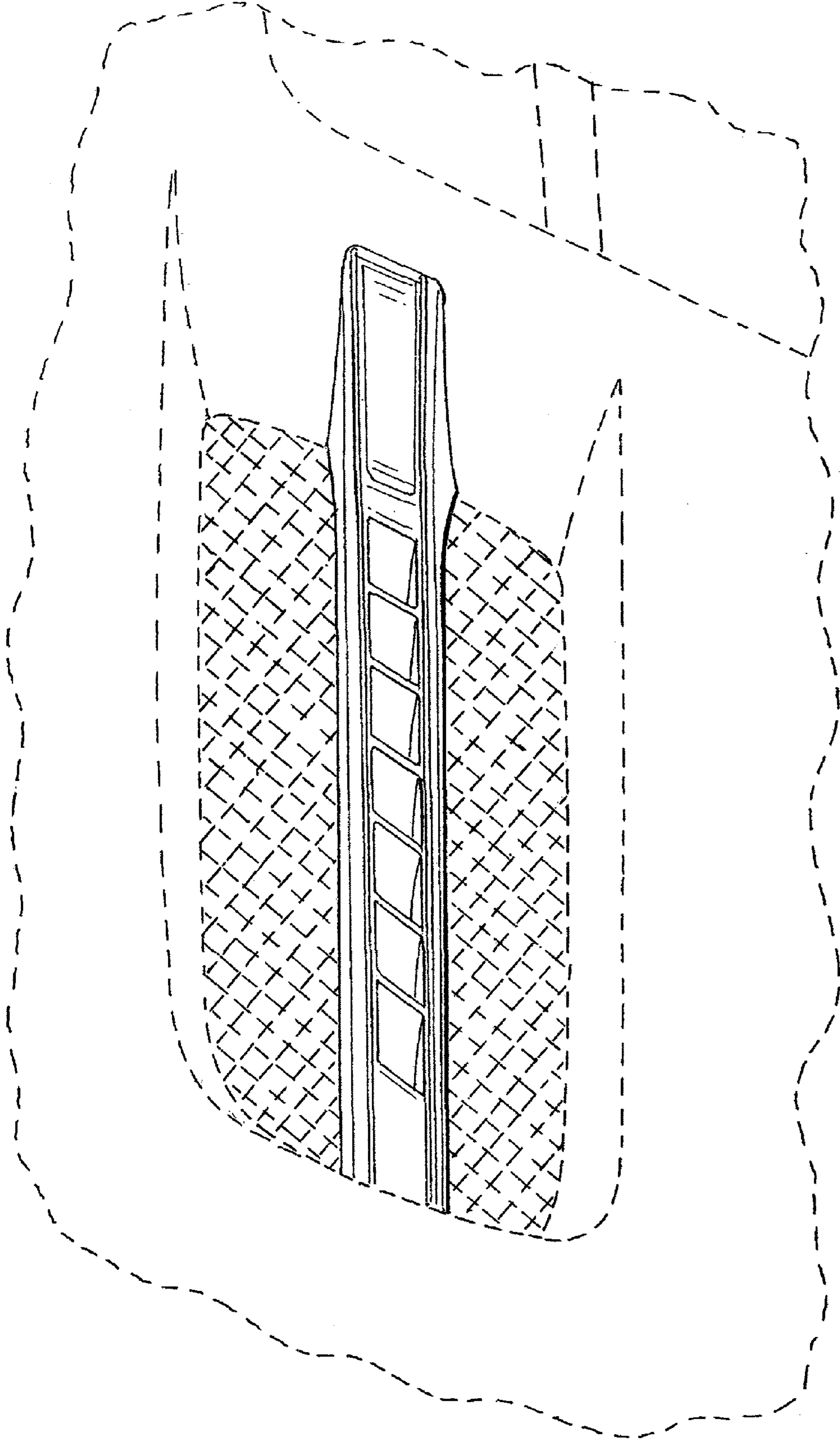

FIG. 2

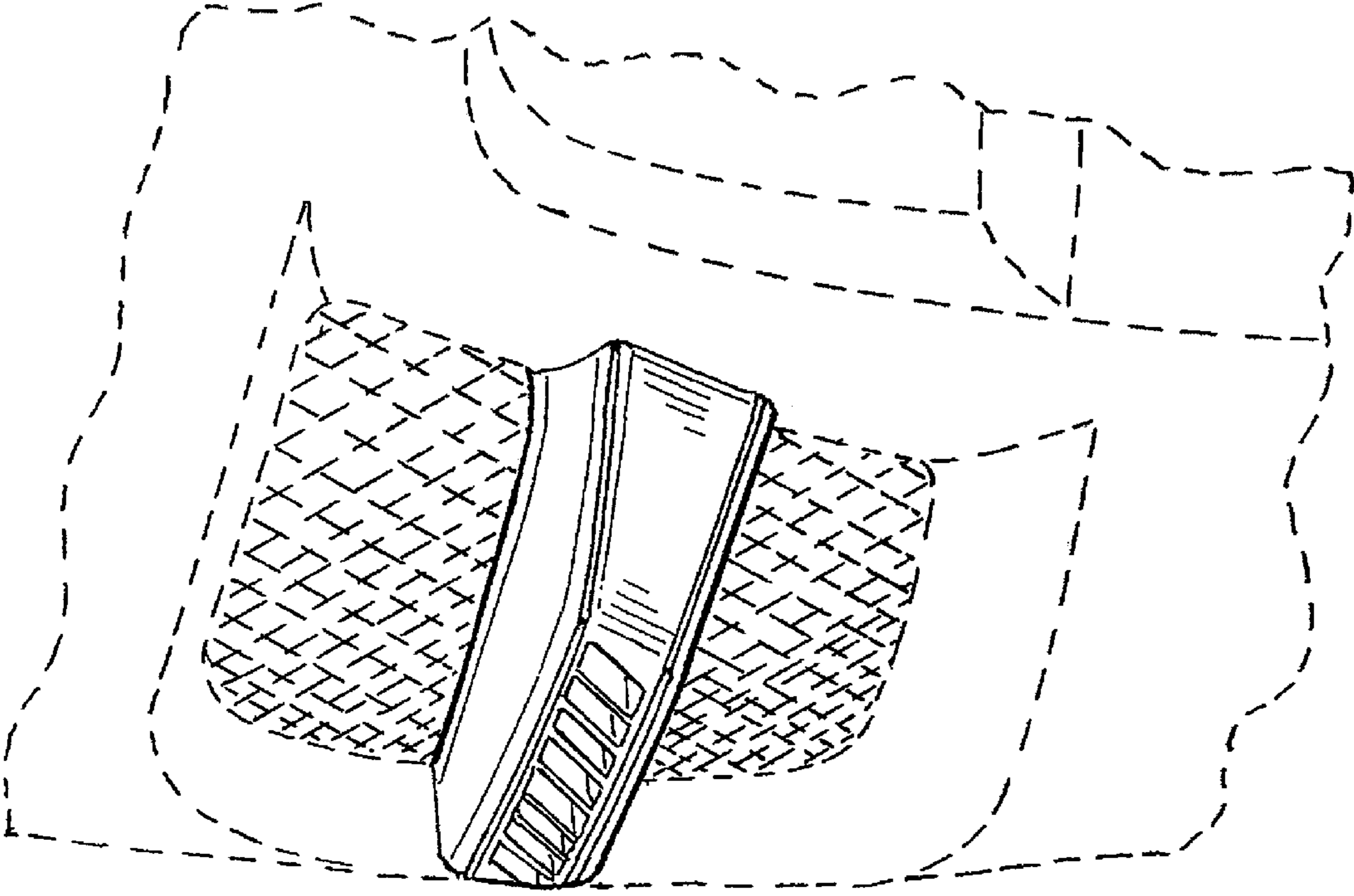

FIG. 3

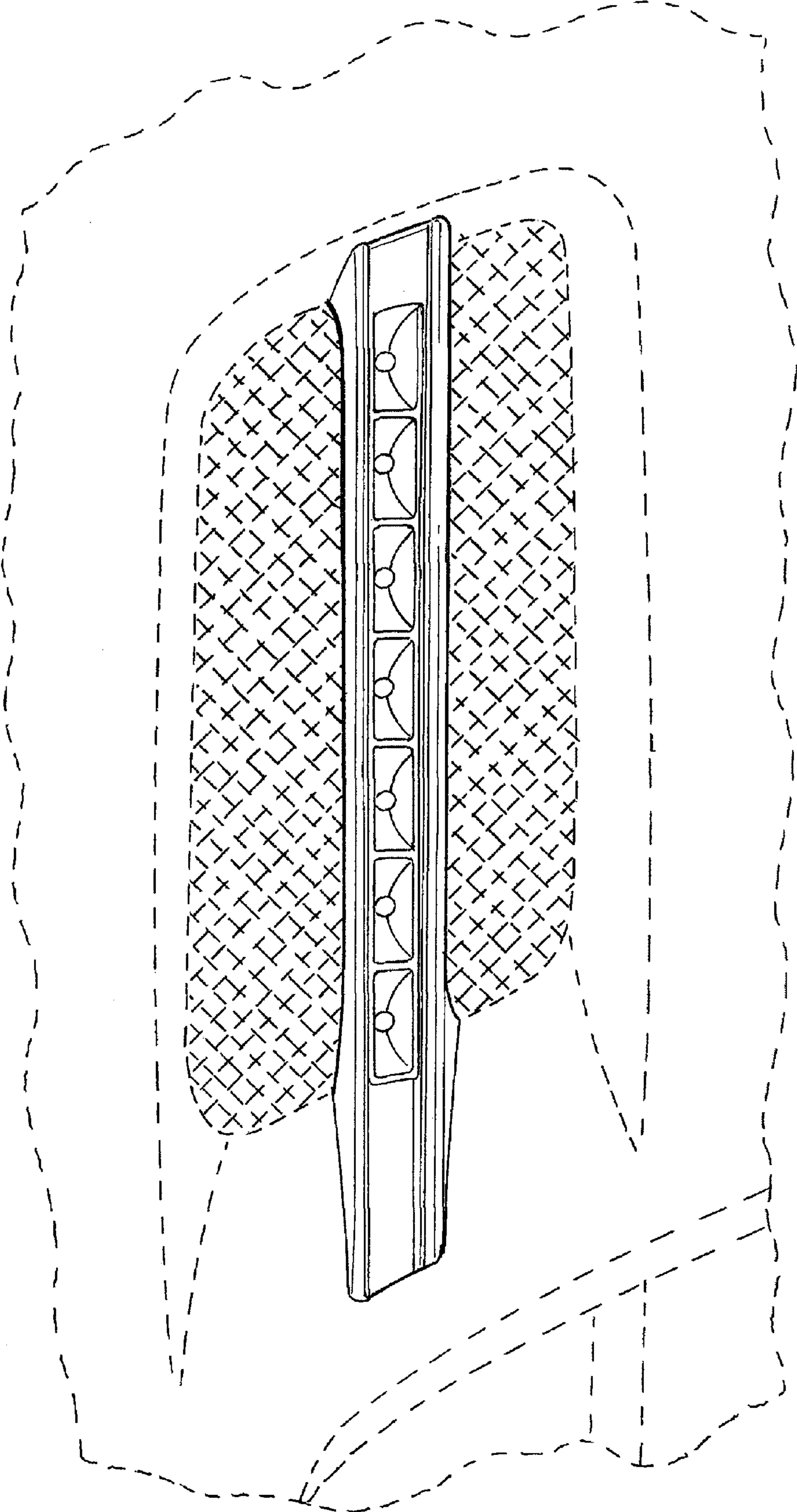

FIG. 4

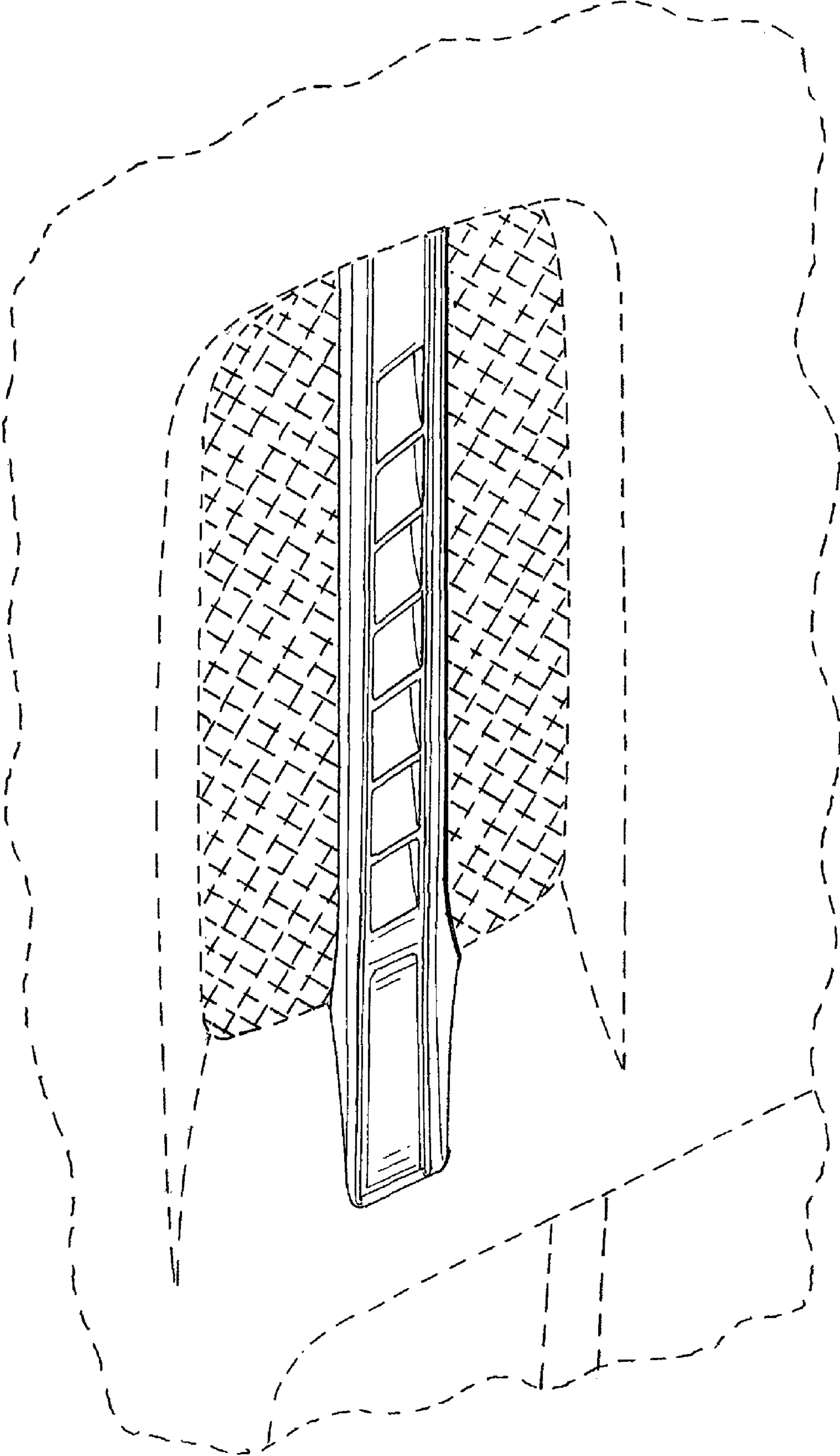

FIG. 5

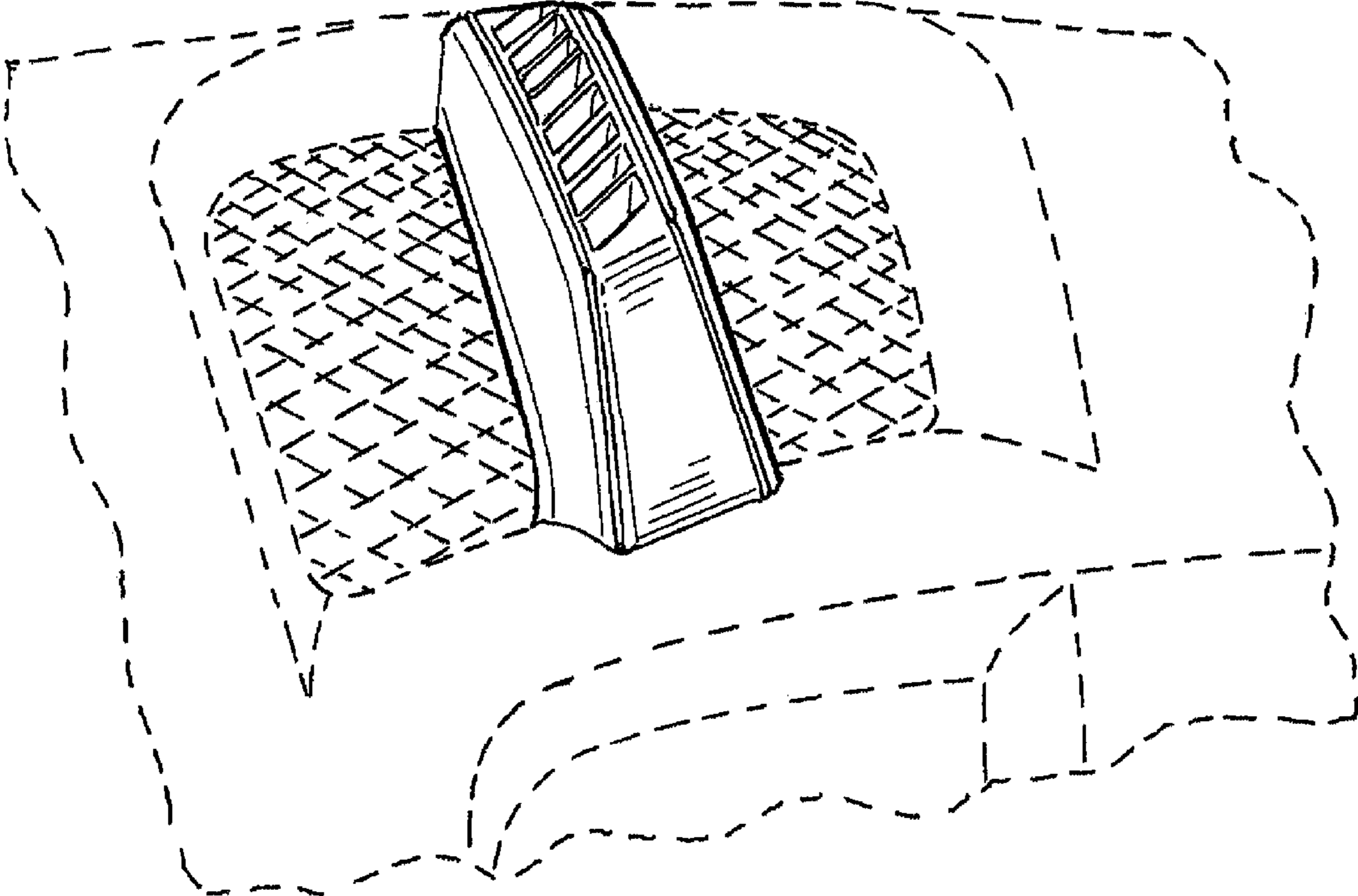

FIG. 6