



US00D641437S

(12) **United States Design Patent**  
**Nugent**

(10) **Patent No.:** **US D641,437 S**  
(45) **Date of Patent:** **\*\* Jul. 12, 2011**

- (54) **BALL THROWING MACHINE**
- (75) Inventor: **Timothy Nugent**, Santa Monica, CA (US)
- (73) Assignee: **Lob-ster, Inc.**, North Hollywood, CA (US)
- (\*\*) Term: **14 Years**
- (21) Appl. No.: **29/368,439**
- (22) Filed: **Aug. 24, 2010**
- (51) **LOC (9) Cl.** ..... **21-02**
- (52) **U.S. Cl.** ..... **D21/722**
- (58) **Field of Classification Search** ..... D21/722,  
D21/720, 698, 780, 789; 473/436; 124/78,  
124/75, 56, 50, 51.1, 81, 44.7  
See application file for complete search history.

- (56) **References Cited**
- U.S. PATENT DOCUMENTS
- 2,918,915 A \* 12/1959 Doeg ..... 124/78
- 3,777,732 A \* 12/1973 Holloway et al. .... 124/78
- 3,913,552 A \* 10/1975 Yarur et al. .... 124/78
- D251,029 S \* 2/1979 Haller et al. .... D21/720
- 4,273,095 A \* 6/1981 Speer ..... 124/56
- D269,894 S \* 7/1983 Hirabayashi et al. .... D21/720
- 4,772,017 A \* 9/1988 Eriksen ..... 473/436
- 4,774,928 A \* 10/1988 Kholin ..... 124/75
- 4,841,945 A \* 6/1989 Braden ..... 124/78
- D373,397 S \* 9/1996 DeBardelaben ..... D21/720
- D456,866 S \* 5/2002 Turpault et al. .... D21/698
- D626,611 S \* 11/2010 Magnone ..... D21/722

- OTHER PUBLICATIONS
- www.sportstutor.com (2010).
- www.playtennismachines.com (2010).

www.mastersports.com (2010).  
2010 Guide to Ball Machines: Find Your Ball Machine, Jul. 2010.  
\* cited by examiner  
*Primary Examiner* — Mitchell Siegel  
(74) *Attorney, Agent, or Firm* — Lerner, David, Littenberg, Krumholz & Mentlik, LLP

(57) **CLAIM**  
The ornamental design for a ball throwing machine, as shown and described.

**DESCRIPTION**

FIG. 1 is a perspective view of a ball throwing machine, in accordance with one embodiment of the present invention. FIG. 2 is a front view of the ball throwing machine shown in FIG. 1. FIG. 3 is a rear view of the ball throwing machine shown in FIG. 1. FIG. 4 is right side view of the ball throwing machine shown in FIG. 1, the left side being a mirror image thereof. FIG. 5 is top view of the ball throwing machine shown in FIG. 1. FIG. 6 is a bottom view of the ball throwing machine shown in FIG. 1; and, FIG. 7 is a perspective view of the ball throwing machine shown in FIG. 1, with an upper portion rotated with respect to a lower portion. Portions of the ball throwing machine shown in the drawings in phantom lines constitute no part of the claimed design.

**1 Claim, 7 Drawing Sheets**

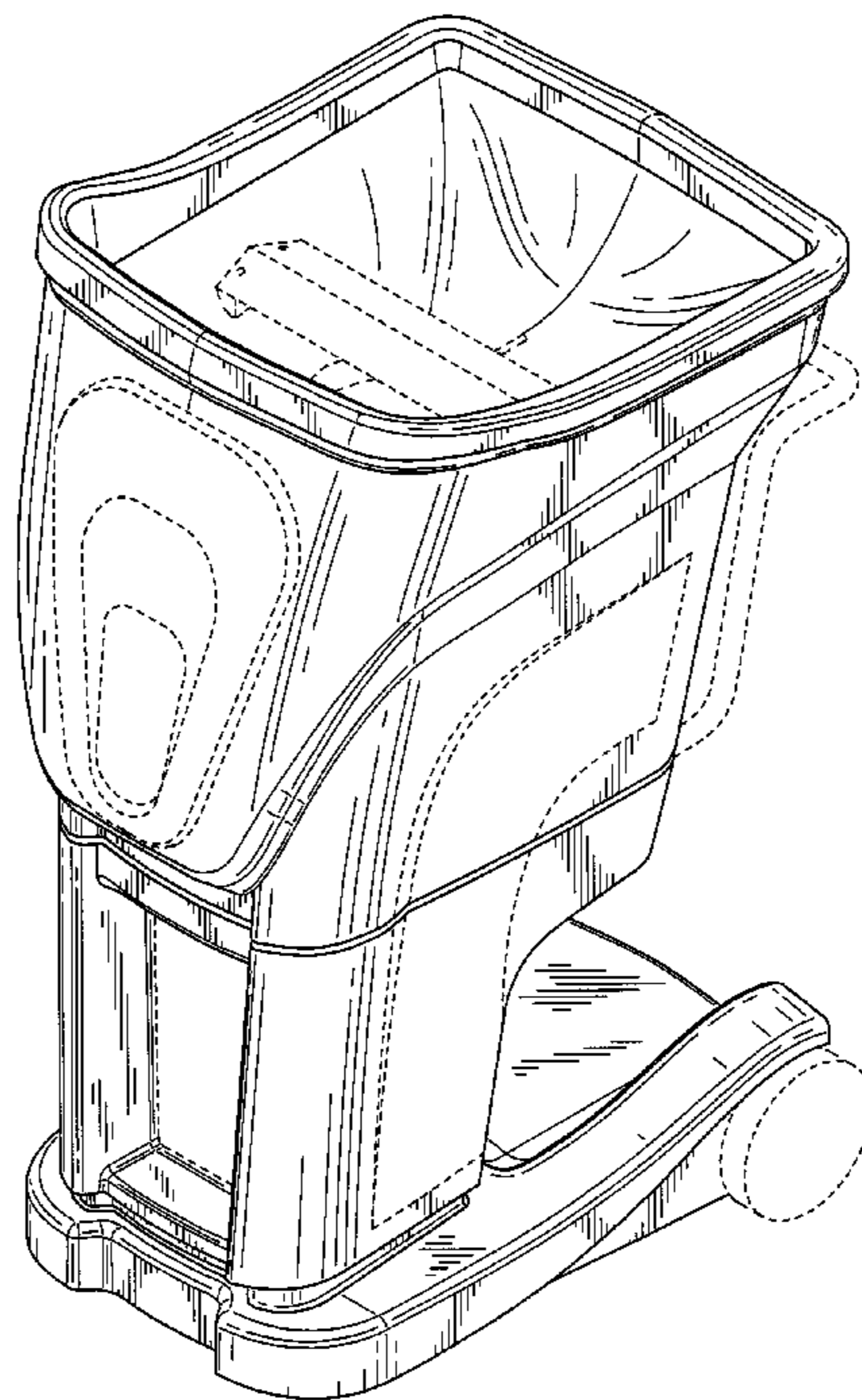

FIG. 1

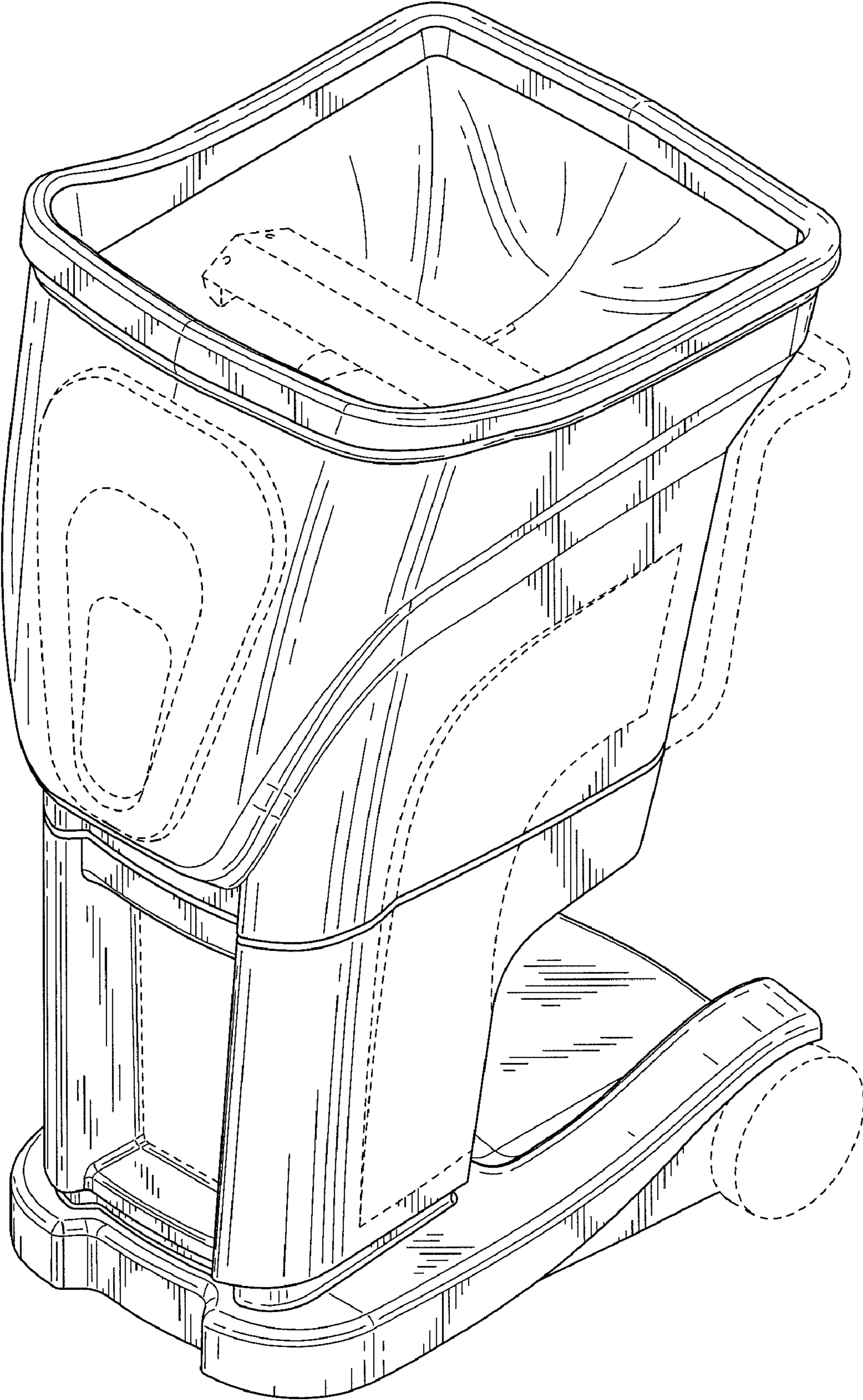

FIG. 2

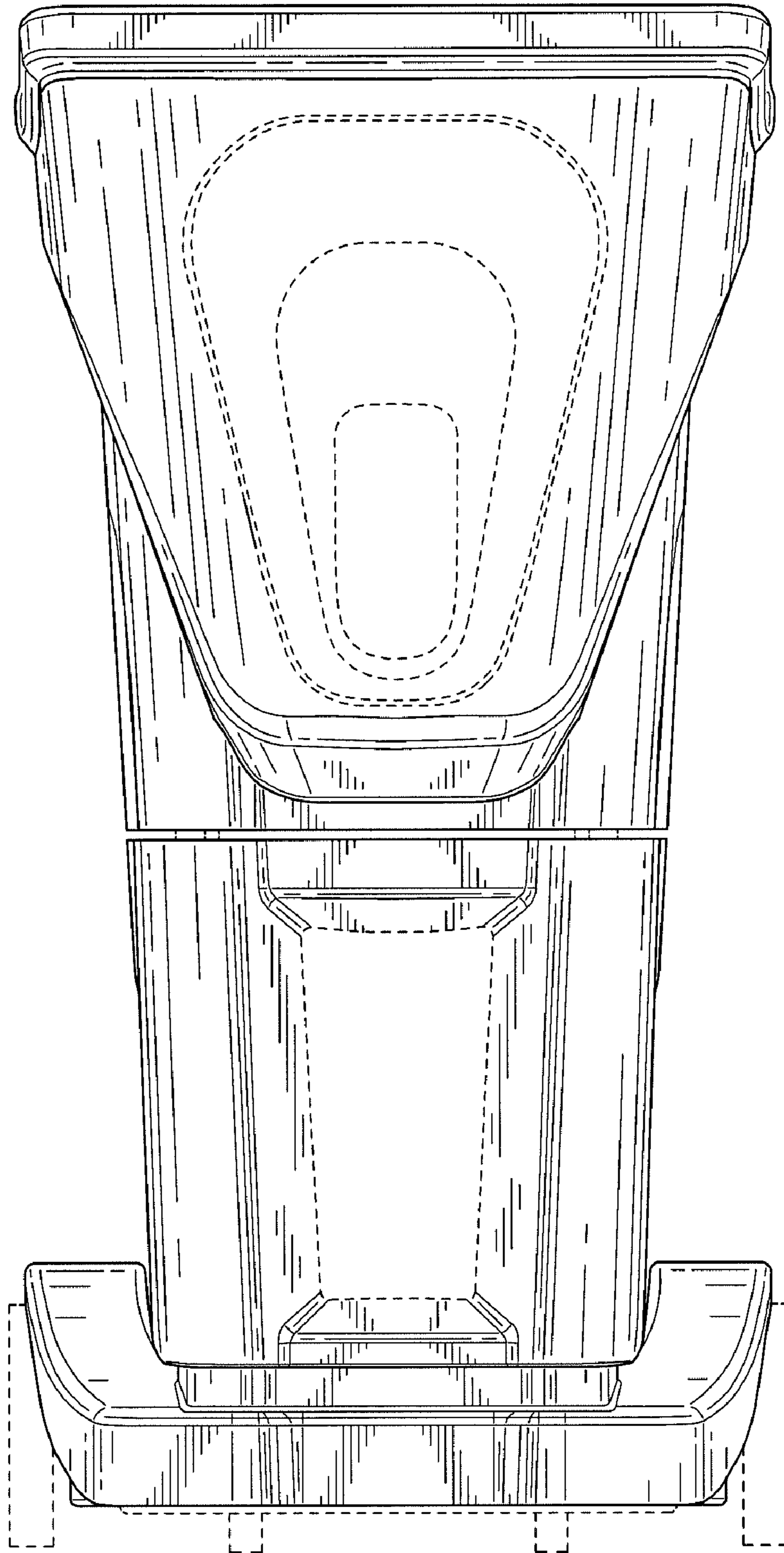

FIG. 3

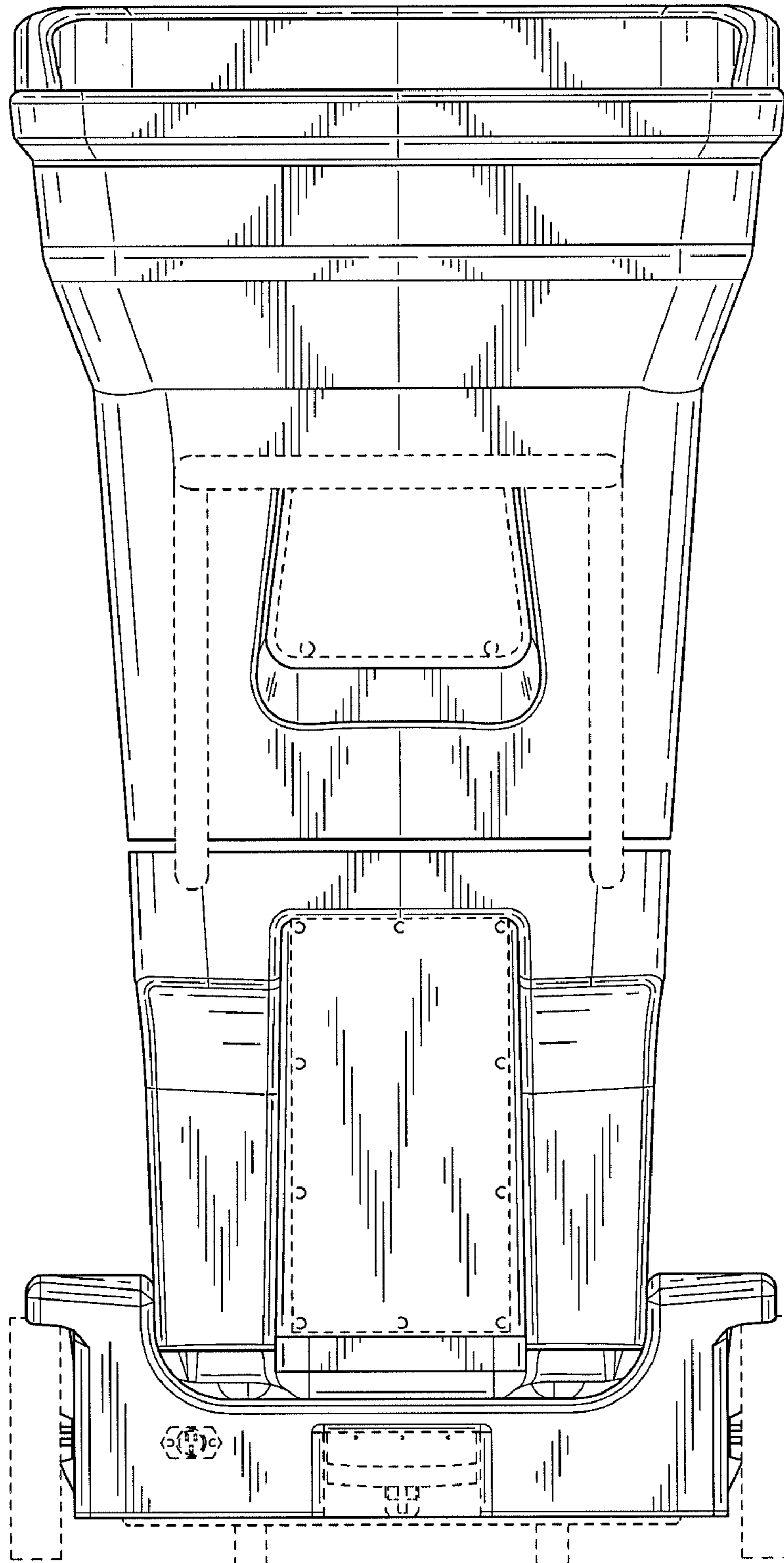

FIG. 4

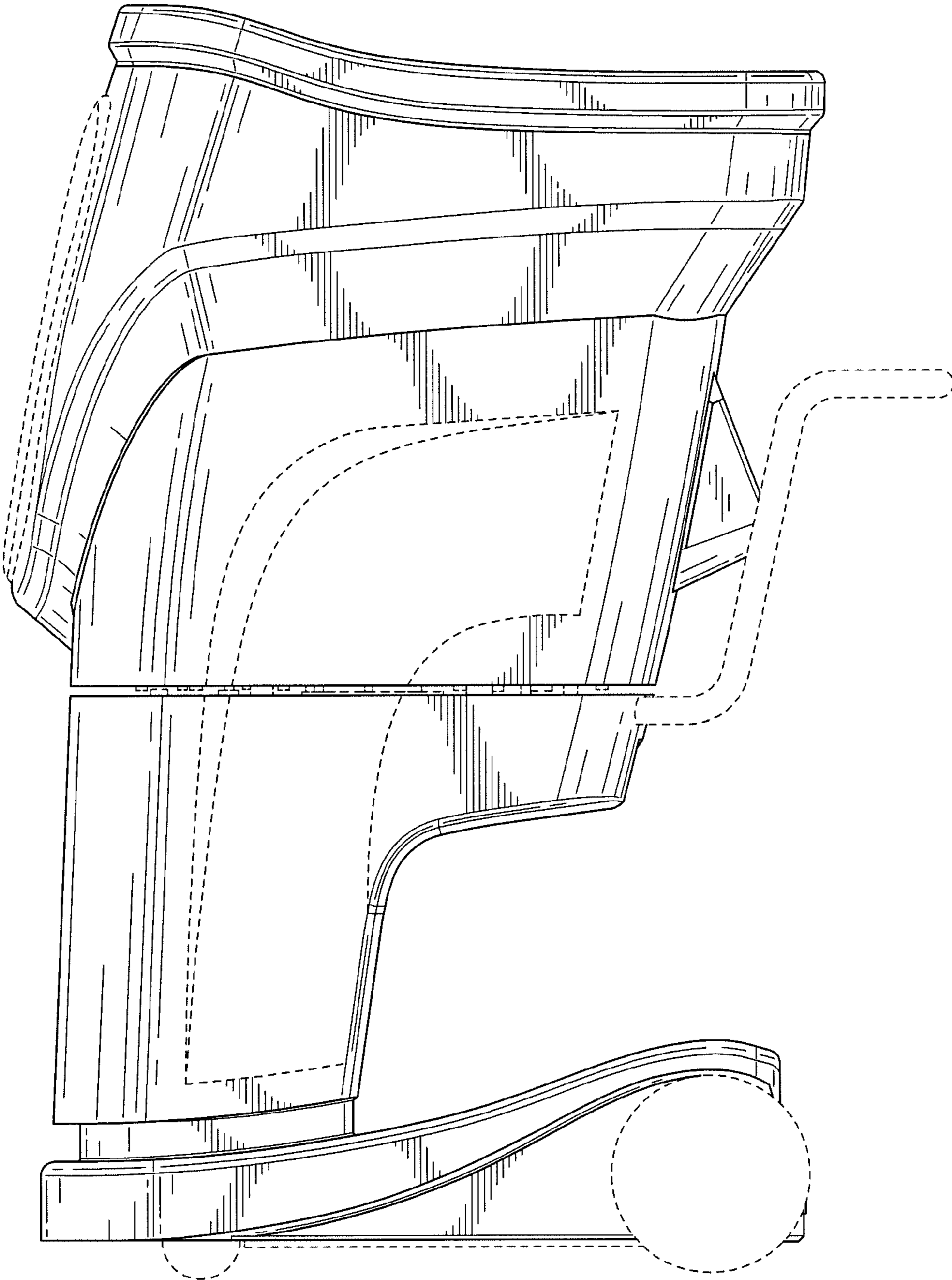

FIG. 5

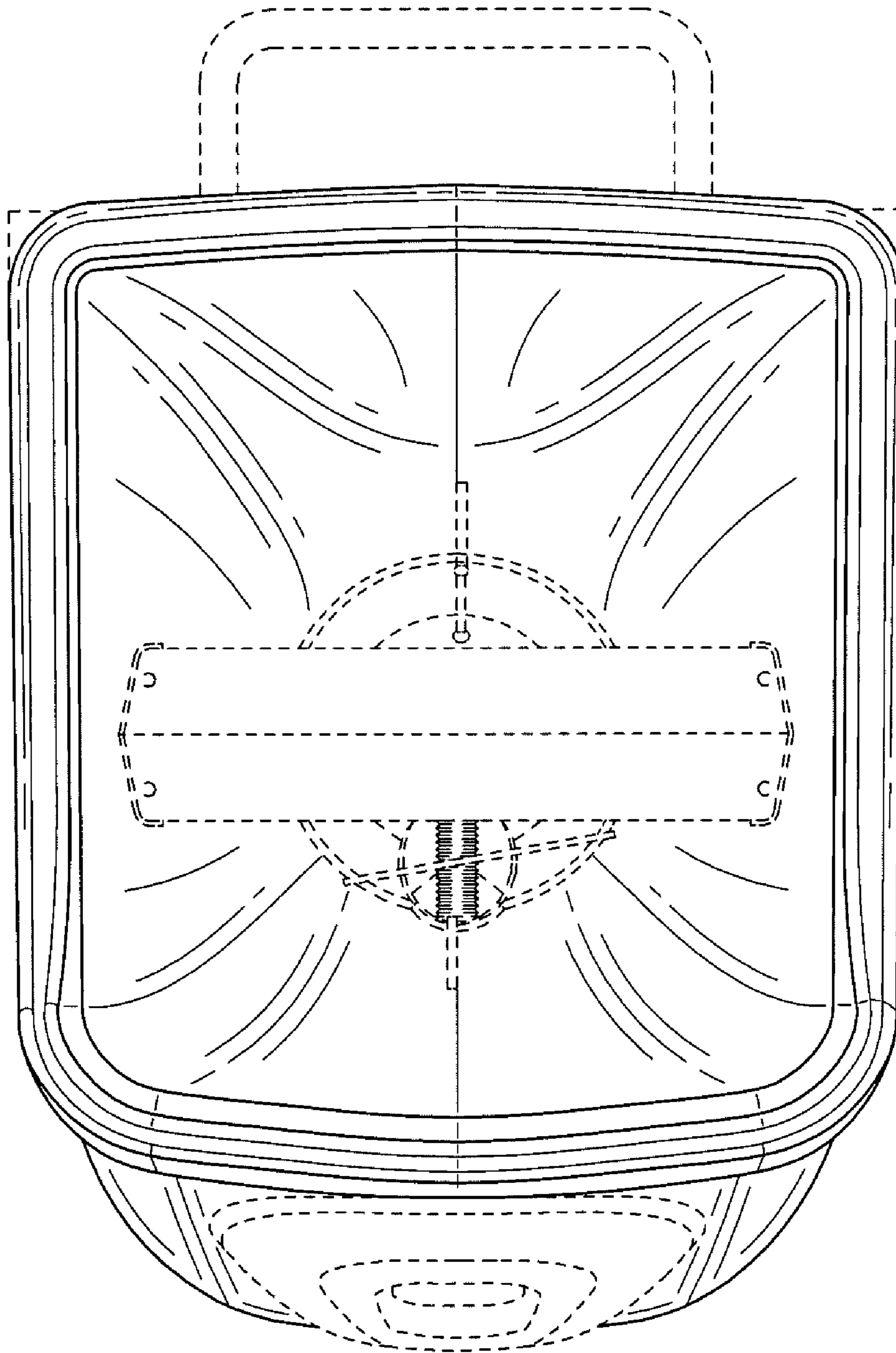

FIG. 6

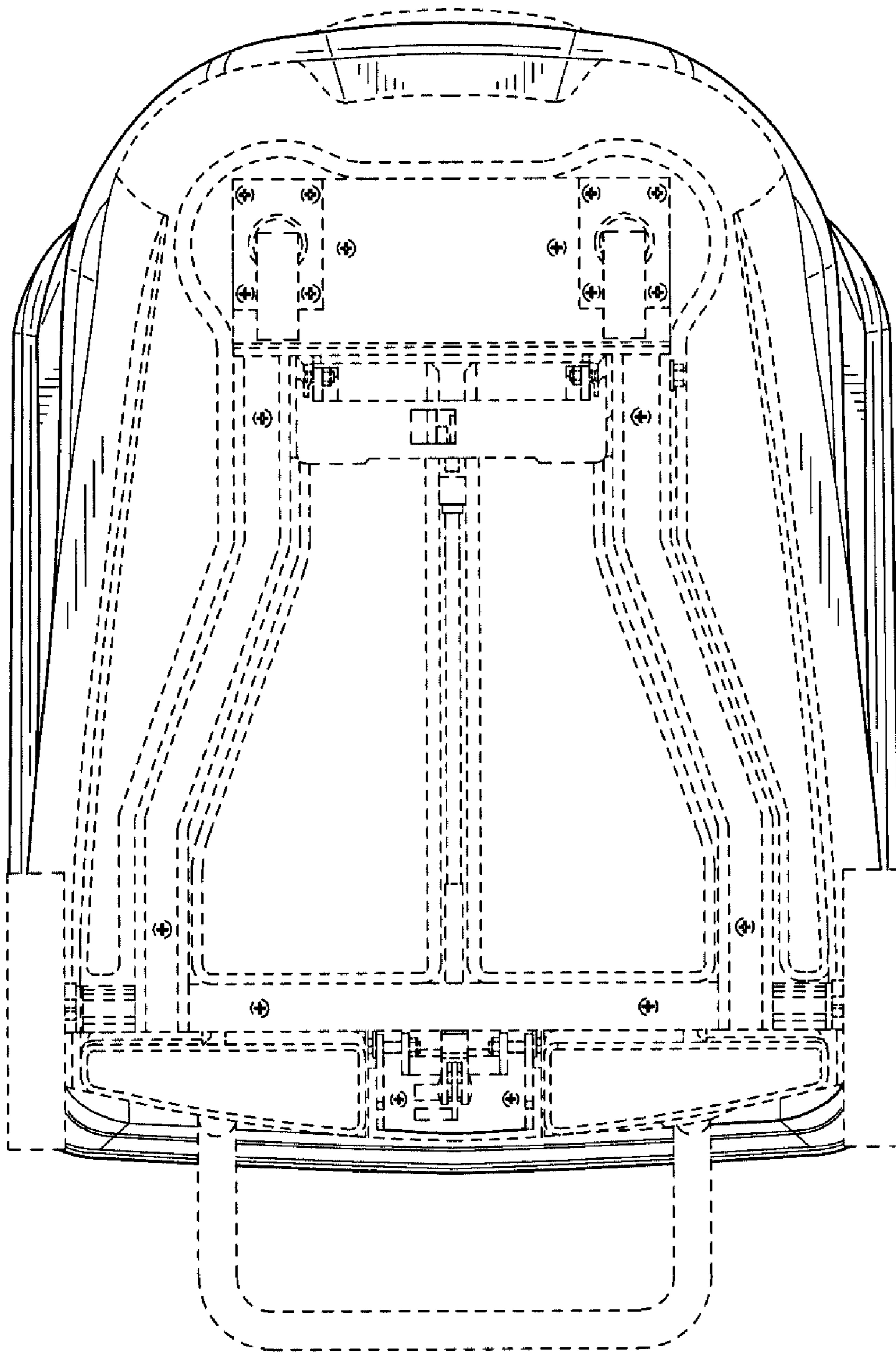

FIG. 7

