



US00D641405S

(12) **United States Design Patent**
Guo

(10) **Patent No.:** **US D641,405 S**
(45) **Date of Patent:** **** Jul. 12, 2011**

(54) **PEN**
(75) **Inventor:** **Yuanqi Guo, Ningbo (CN)**
(73) **Assignee:** **Beifa Group Co., Ltd., Ningbo (CN)**
(**) **Term:** **14 Years**
(21) **Appl. No.:** **29/364,901**

D543,237 S * 5/2007 Bickert et al. D19/42
D546,389 S 7/2007 Chiaruttini
D548,788 S 8/2007 Anand
D550,281 S * 9/2007 Tien D19/48
D562,895 S 2/2008 Shibata
D563,469 S 3/2008 Qiu
D567,857 S 4/2008 Qiu
D570,412 S 6/2008 Qiu
D579,496 S 10/2008 Qiu

(Continued)

(22) **Filed:** **Jun. 30, 2010**

(30) **Foreign Application Priority Data**

Dec. 31, 2009 (CN) 2009 3 0385686

(51) **LOC (9) Cl.** **19-06**
(52) **U.S. Cl.** **D19/48**
(58) **Field of Classification Search** D19/35,
D19/36, 41-51, 54-58; 24/11 F, 11 P, 11 R;
401/52, 99, 100, 104-109, 192, 195, 196
See application file for complete search history.

FOREIGN PATENT DOCUMENTS

EM 000845060-0005 12/2007

OTHER PUBLICATIONS

Fei, Y., "Pen," U.S. Appl. No. 29/298,536, filed Dec. 6, 2007.

(Continued)

Primary Examiner — Elizabeth Albert
(74) *Attorney, Agent, or Firm* — Christensen O'Connor
Johnson Kindness PLLC

(56) **References Cited**

U.S. PATENT DOCUMENTS

D407,114 S 3/1999 Sakuno
D441,017 S 4/2001 Gault
D444,498 S * 7/2001 Izushima D19/49
D480,756 S 10/2003 Hwang
D490,107 S 5/2004 Wong
D490,108 S 5/2004 Moon
D490,465 S 5/2004 Qiu
D492,349 S 6/2004 Qiu
D499,139 S 11/2004 Oka
D506,503 S 6/2005 Qiu
D506,506 S 6/2005 Qiu
D512,098 S 11/2005 Qiu
D537,877 S 3/2007 Bickert
D539,345 S * 3/2007 Bickert et al. D19/42
D540,386 S 4/2007 Qiu
D540,861 S * 4/2007 Bickert et al. D19/42

(57) **CLAIM**
The ornamental design for a pen, as shown and described.

DESCRIPTION

FIG. 1 is a front right perspective view of a pen showing my new design;
FIG. 2 is a right side elevation view thereof, with the left side elevation view being a minor image of the right side elevation view;
FIG. 3 is a front elevation view thereof;
FIG. 4 is a rear elevation view thereof;
FIG. 5 is an enlarged top plan view thereof; and,
FIG. 6 is an enlarged bottom plan view thereof.
The stippling in the drawings represents a texture on the surface of the pen.

1 Claim, 3 Drawing Sheets

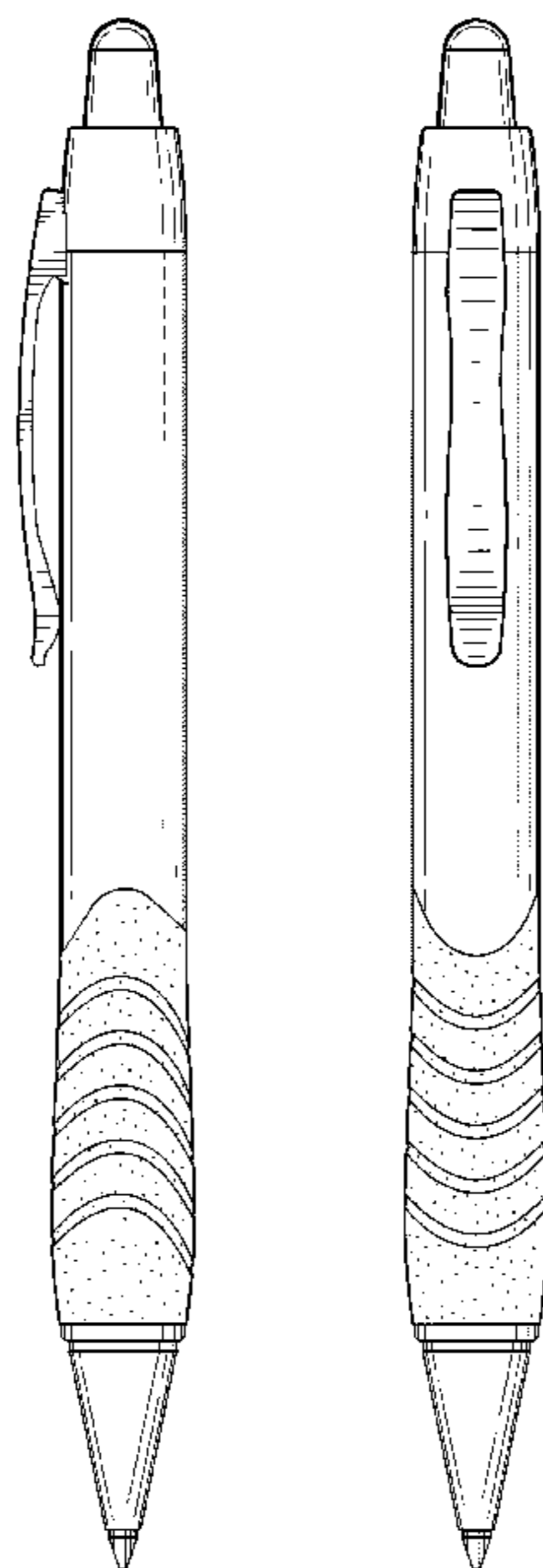

US D641,405 S

Page 2

U.S. PATENT DOCUMENTS

D583,864 S 12/2008 Liu
D585,492 S * 1/2009 Booker D19/50
D609,744 S 2/2010 Rathod
D611,535 S 3/2010 Shimizu
D619,169 S * 7/2010 Kent et al. D19/48
D619,170 S * 7/2010 Kent et al. D19/55
D623,223 S * 9/2010 Chaffee et al. D19/36

D626,995 S * 11/2010 Ikeda D19/48
D628,643 S * 12/2010 Li D19/50
D628,645 S * 12/2010 Zhang D19/51
D633,142 S * 2/2011 Chaffee et al. D19/36

OTHER PUBLICATIONS

Li, B., "Pen," U.S. Appl. No. 29/363,162, filed Jun. 4, 2010.

* cited by examiner

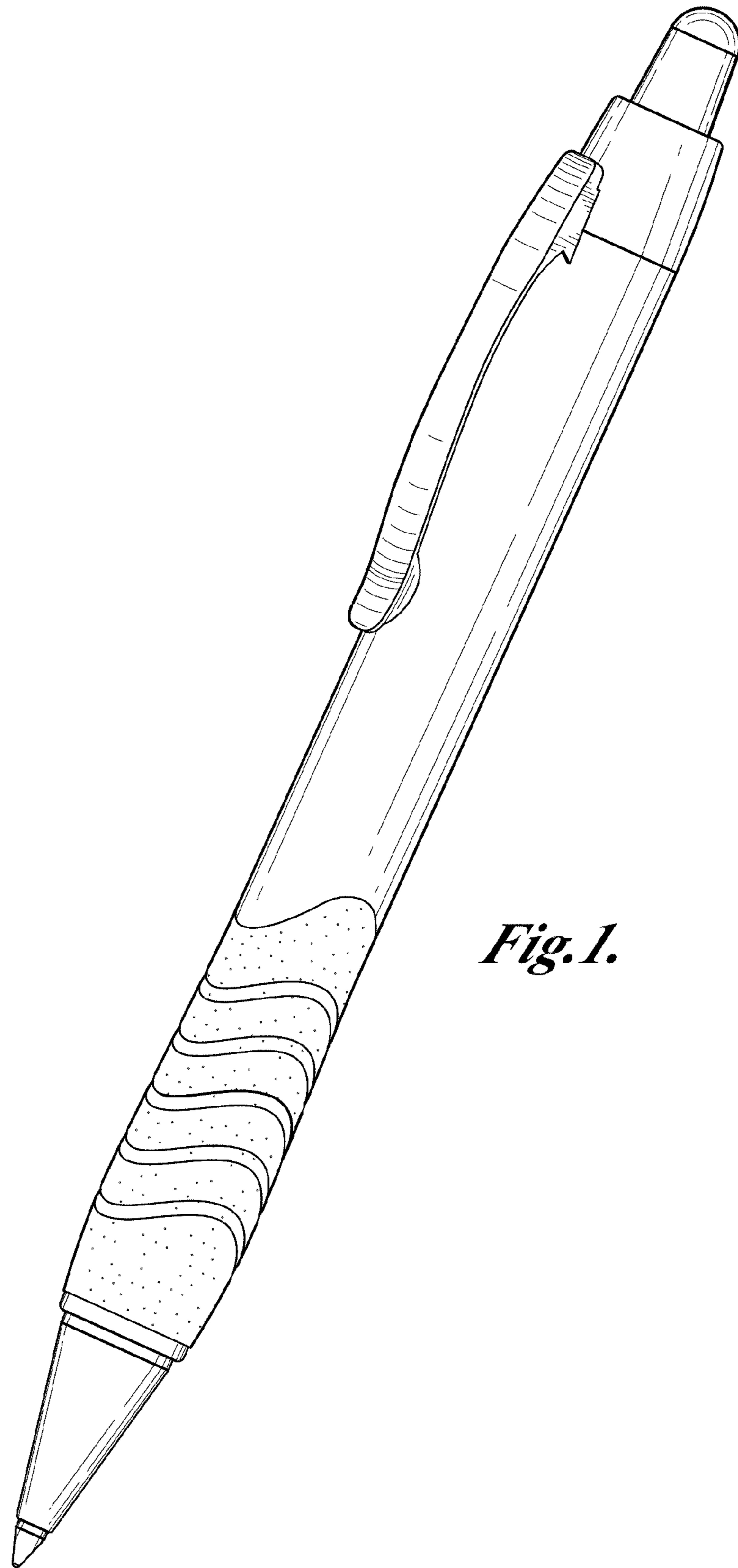

Fig. 1.

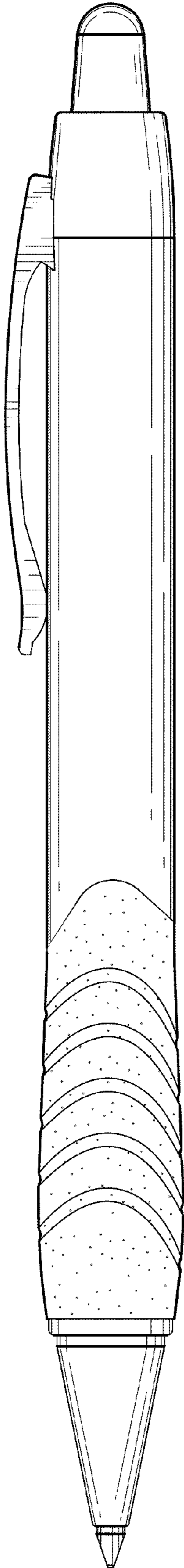

Fig. 2.

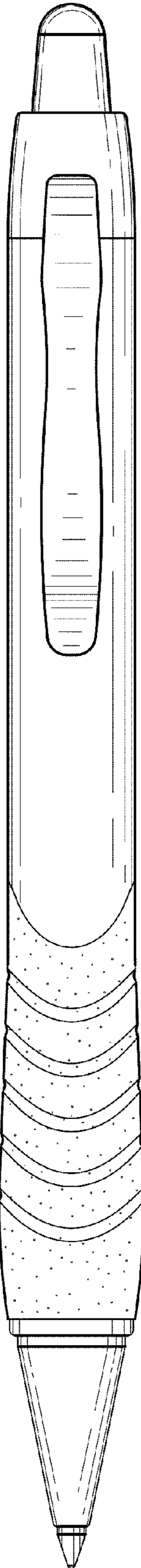

Fig. 3.

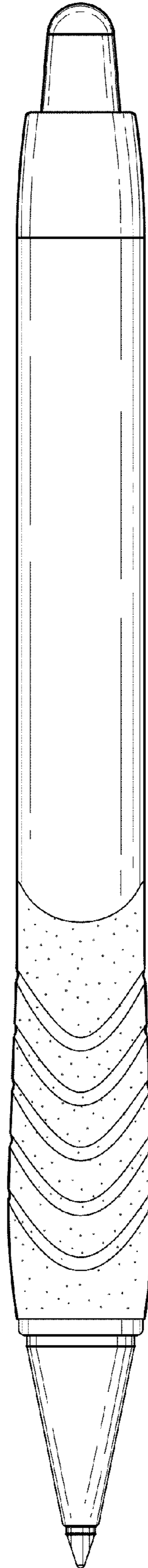

Fig. 4.

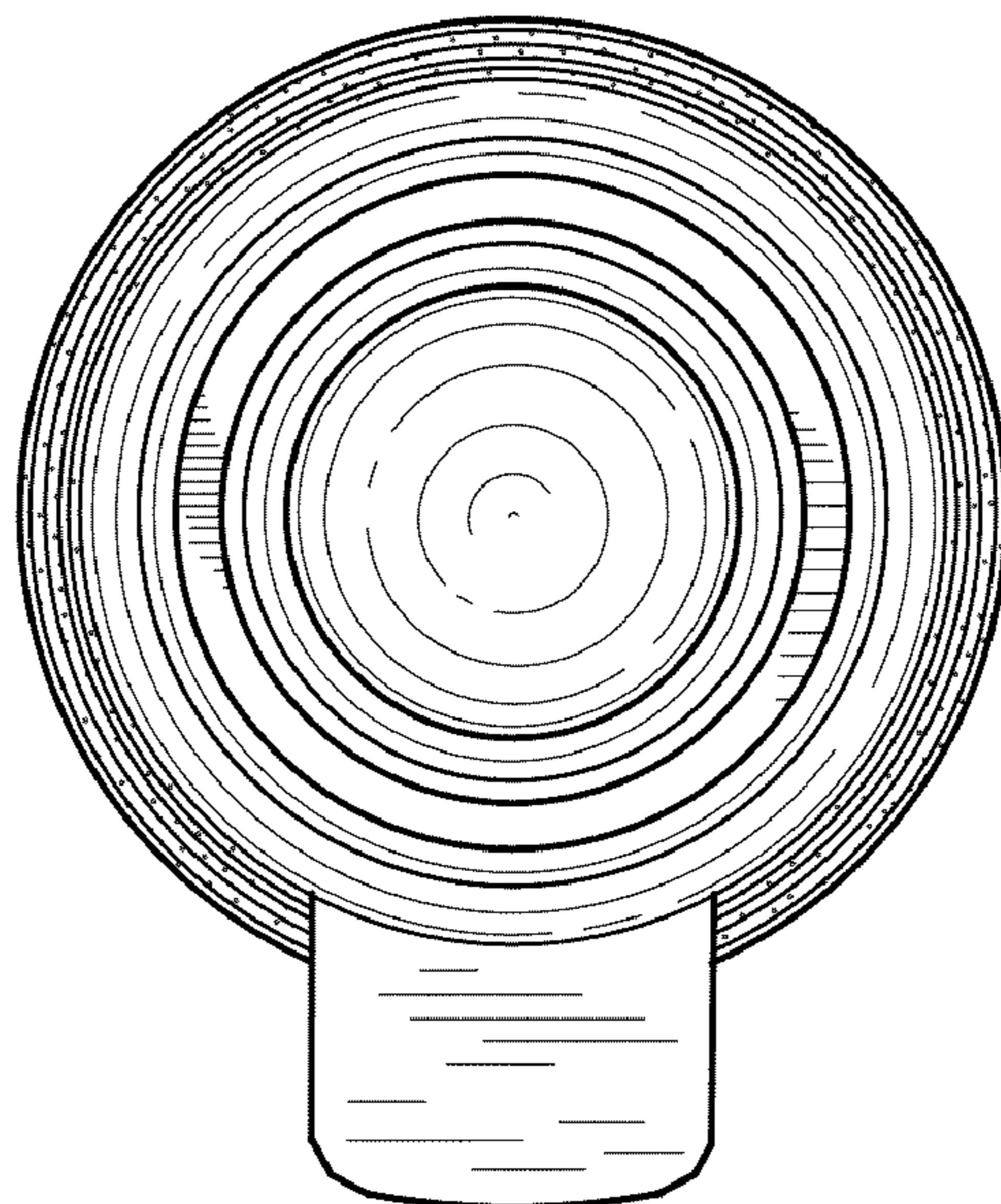

Fig. 5.

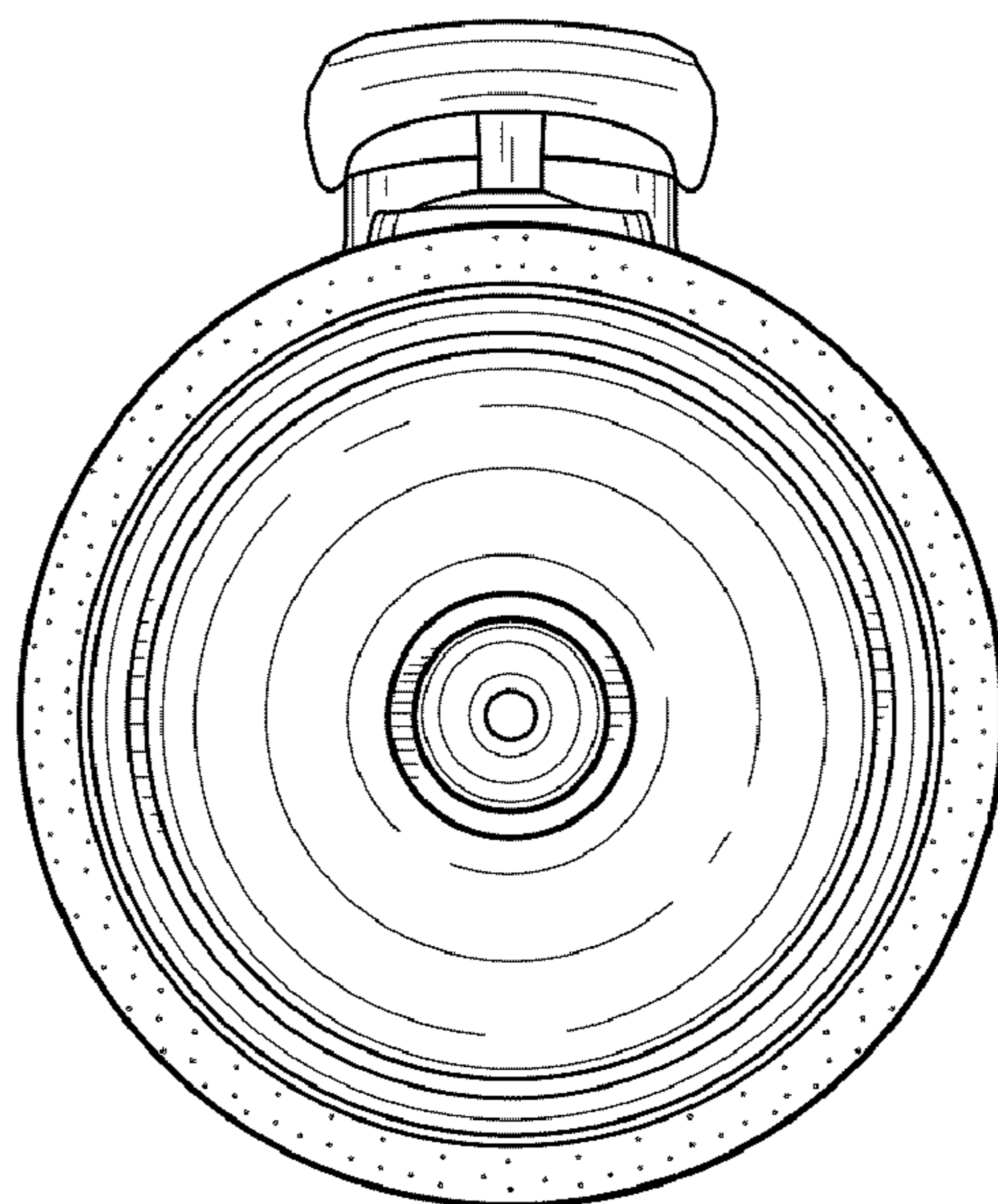

Fig. 6.

UNITED STATES PATENT AND TRADEMARK OFFICE
CERTIFICATE OF CORRECTION

PATENT NO. : D641,405 S
APPLICATION NO. : 29/364901
DATED : July 12, 2011
INVENTOR(S) : Y. Guo

Page 1 of 1

It is certified that error appears in the above-identified patent and that said Letters Patent is hereby corrected as shown below:

<u>COLUMN</u>	<u>LINE</u>	<u>ERROR</u>
(57) Pg. 1, col. 2	Description, Line 4	“a minor image” should read --a mirror image--

Signed and Sealed this
First Day of November, 2011



David J. Kappos
Director of the United States Patent and Trademark Office