



US00D641372S

(12) **United States Design Patent**
Gardner et al.

(10) **Patent No.:** **US D641,372 S**

(45) **Date of Patent:** **** Jul. 12, 2011**

(54) **DISPLAY SCREEN WITH ANIMATED USER INTERFACE**

(75) Inventors: **David Gardner**, Covington, WA (US); **Ali Vassigh**, Redmond, WA (US); **Cyrus Kanga**, Redmond, WA (US); **Michael Kleinerman**, Redmond, WA (US); **James Lee**, Lynwood, WA (US); **Julian Selman**, Redmond, WA (US)

(73) Assignee: **Microsoft Corporation**, Redmond, WA (US)

(**) Term: **14 Years**

(21) Appl. No.: **29/363,640**

(22) Filed: **Jun. 11, 2010**

(51) **LOC (9) Cl.** **32-00**

(52) **U.S. Cl.** **D14/486**

(58) **Field of Classification Search** D14/485-495;
715/700-867

See application file for complete search history.

(56) **References Cited**

U.S. PATENT DOCUMENTS

D438,873	S	*	3/2001	Wang et al.	D14/486
D440,575	S	*	4/2001	Wang et al.	D14/489
D445,426	S	*	7/2001	Wang et al.	D14/486
D446,790	S	*	8/2001	Wang et al.	D14/486
D539,810	S	*	4/2007	Cummins	D14/489
D540,343	S	*	4/2007	Cummins	D14/489
D556,768	S	*	12/2007	Morris	D14/487
D582,426	S	*	12/2008	Chen et al.	D14/488
D585,453	S		1/2009	Chen et al.		
D588,154	S		3/2009	Bouchard et al.		
D589,528	S	*	3/2009	Koh	D14/486
D593,110	S	*	5/2009	Danton	D14/485
D593,120	S		5/2009	Bouchard et al.		
D594,020	S	*	6/2009	Ball et al.	D14/486
7,552,387	B2	*	6/2009	Shen et al.	715/716
D599,368	S	*	9/2009	Kanga et al.	D14/485
D599,373	S	*	9/2009	Kobayashi et al.	D14/486
D599,806	S	*	9/2009	Brown et al.	D14/485
D603,416	S	*	11/2009	Poling et al.	D14/485
D605,657	S	*	12/2009	Danton	D14/487

D607,468	S	*	1/2010	Ho	D14/486
7,747,968	B2	*	6/2010	Brodersen et al.	715/821
D624,088	S	*	9/2010	Salay et al.	D14/486
D627,790	S	*	11/2010	Chaudhri	D14/486
7,864,163	B2	*	1/2011	Ording et al.	345/173
D633,920	S	*	3/2011	Luke et al.	D14/488
D633,921	S	*	3/2011	Brinda	D14/488
2009/0249400	A1	*	10/2009	Carlberg et al.	725/44
2010/0125786	A1	*	5/2010	Ozawa et al.	715/702

* cited by examiner

Primary Examiner — Cathron Brooks

Assistant Examiner — Deanna Fluegeman

(74) *Attorney, Agent, or Firm* — Banner & Witcoff, Ltd.

(57) **CLAIM**

The ornamental design for a display screen with animated user interface, as shown and described.

DESCRIPTION

FIG. 1 is a first image in the sequence for an display screen with animated user interface showing our new design; FIG. 2 is the second image thereof; FIG. 3 is the third image thereof; FIG. 4 is the fourth image thereof; FIG. 5 is the fifth image thereof; FIG. 6 is the sixth image thereof; FIG. 7 is the seventh image thereof; FIG. 8 is the eighth image thereof; FIG. 9 is the ninth image thereof; FIG. 10 is the tenth image thereof; FIG. 11 is the eleventh image thereof; FIG. 12 is the twelfth image thereof; FIG. 13 is the thirteenth image thereof; and, FIG. 14 is the fourteenth image thereof.

The appearance of the user interface sequentially transitions between the images shown in FIGS. 1-14. The process or period in which one image transitions to another forms no part of the claimed design. The broken line showing of the display screen and the portions of the animated user interface illustrate unclaimed environment and form no part of the claimed design.

1 Claim, 14 Drawing Sheets

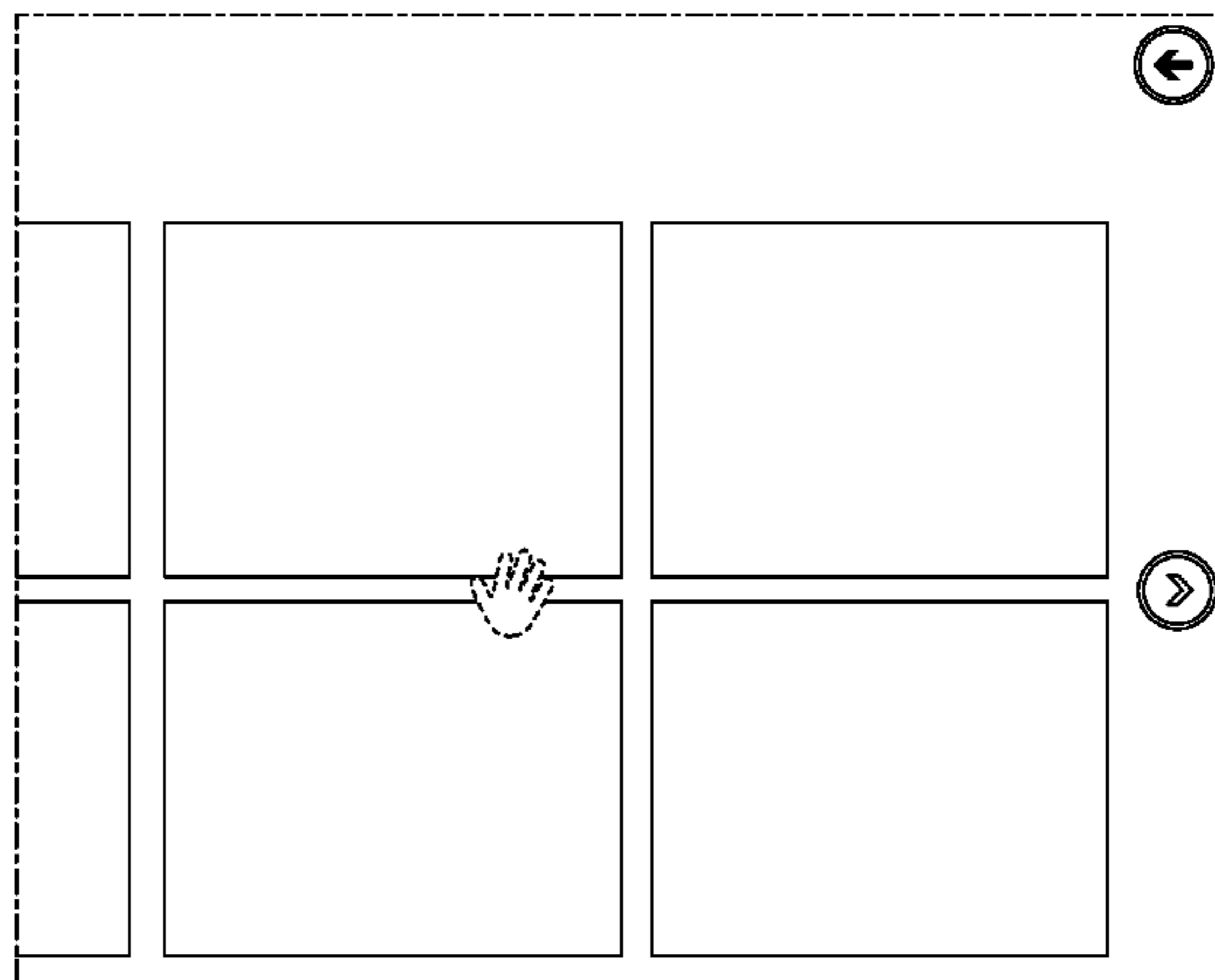
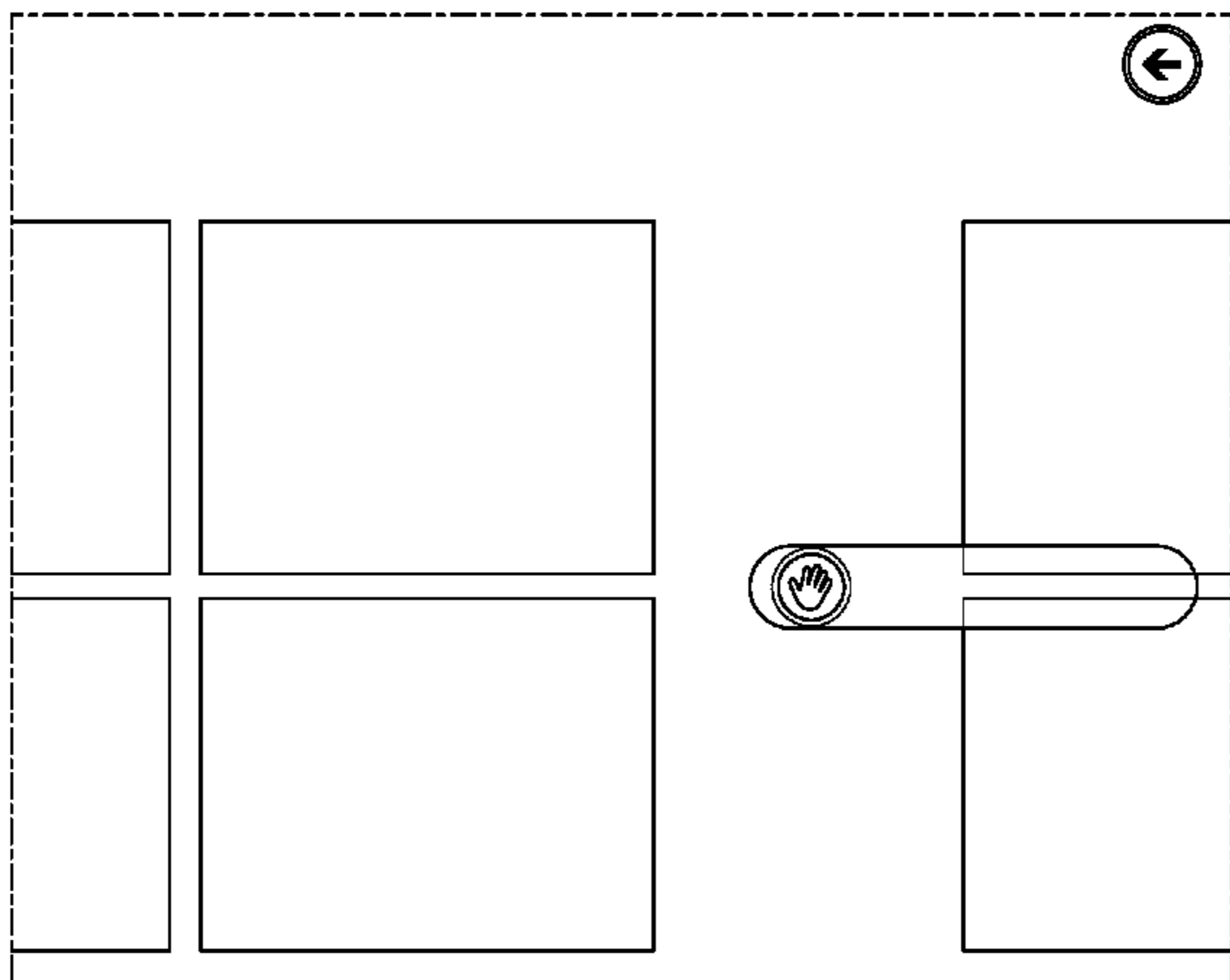

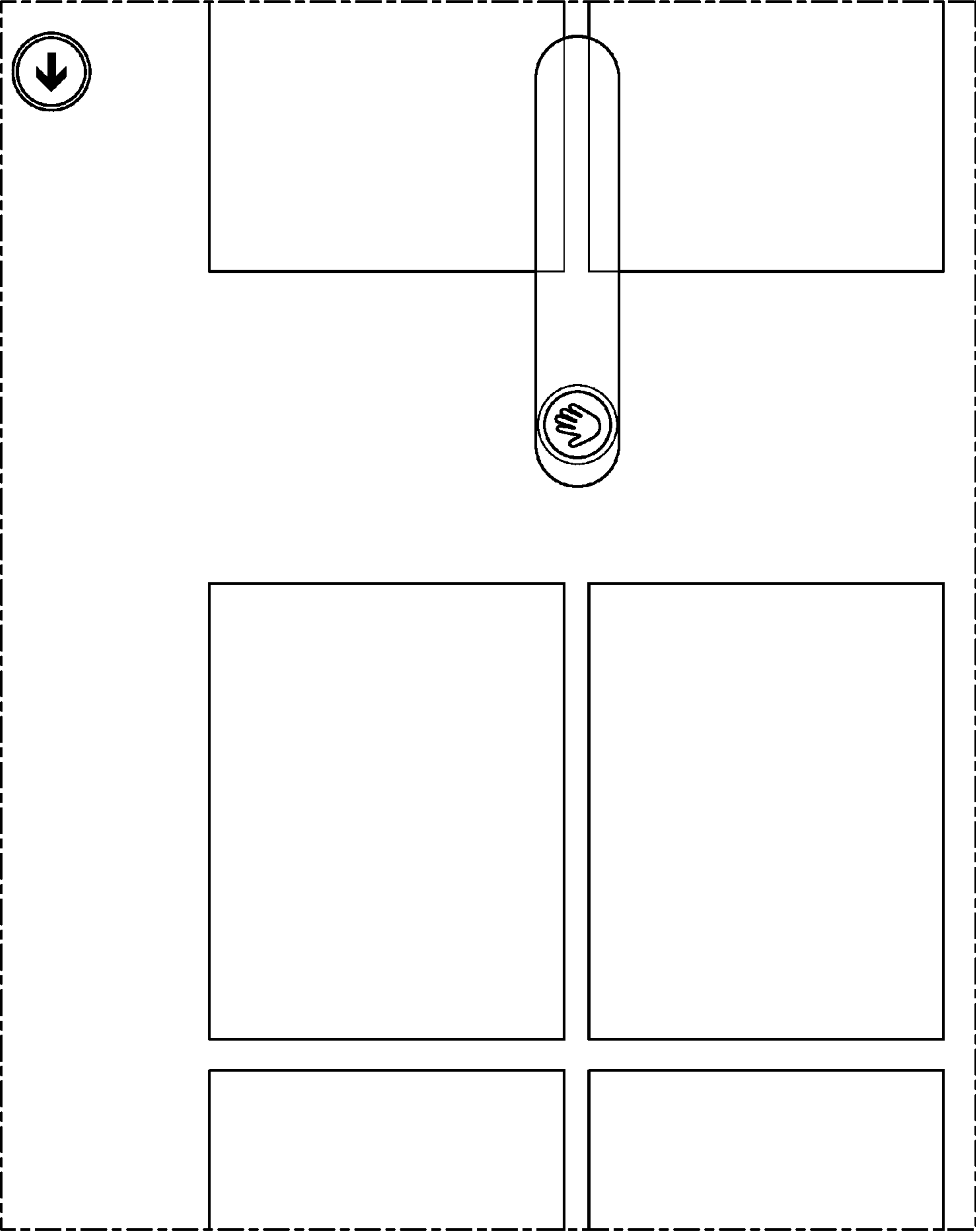

FIG. 1

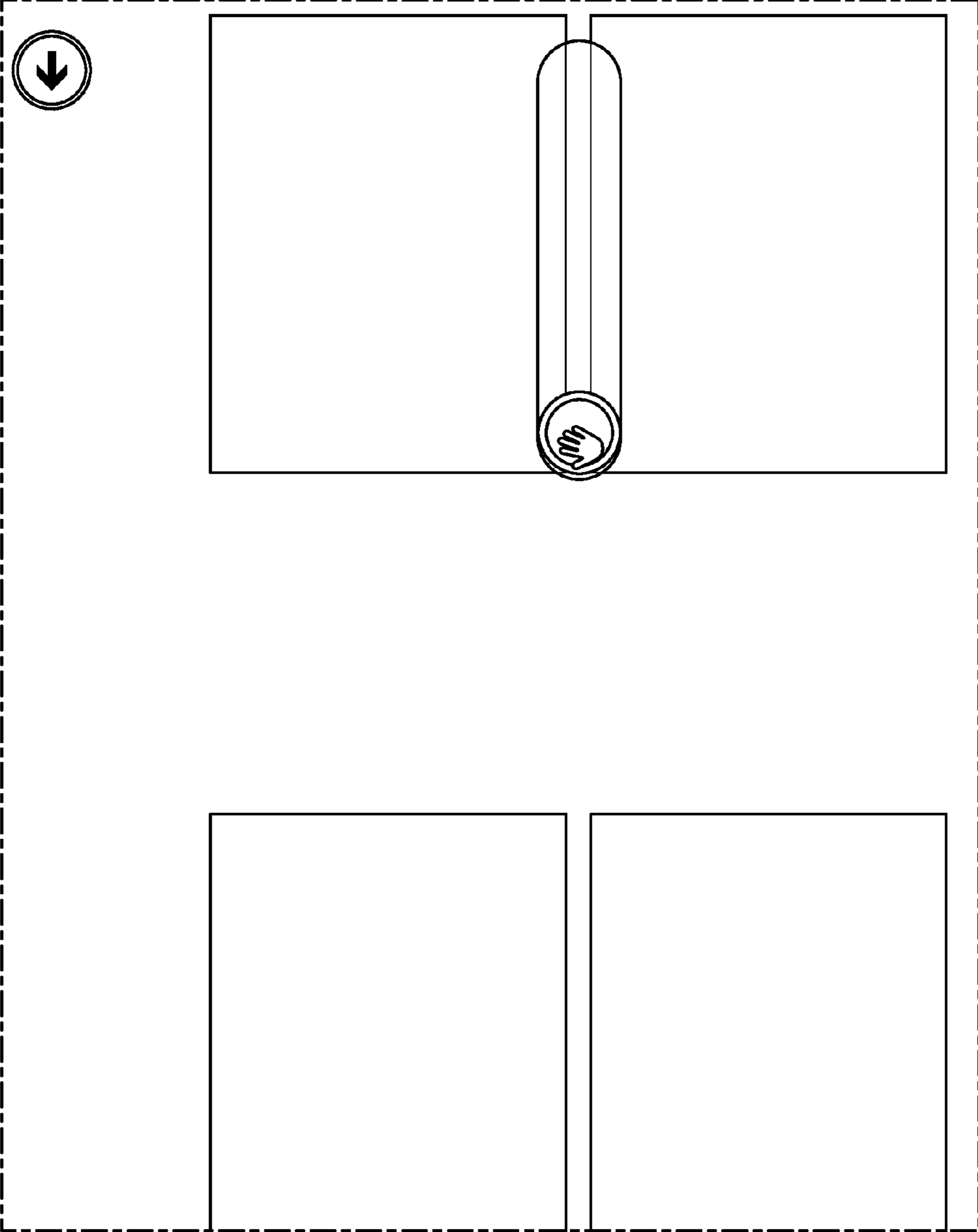

FIG. 2

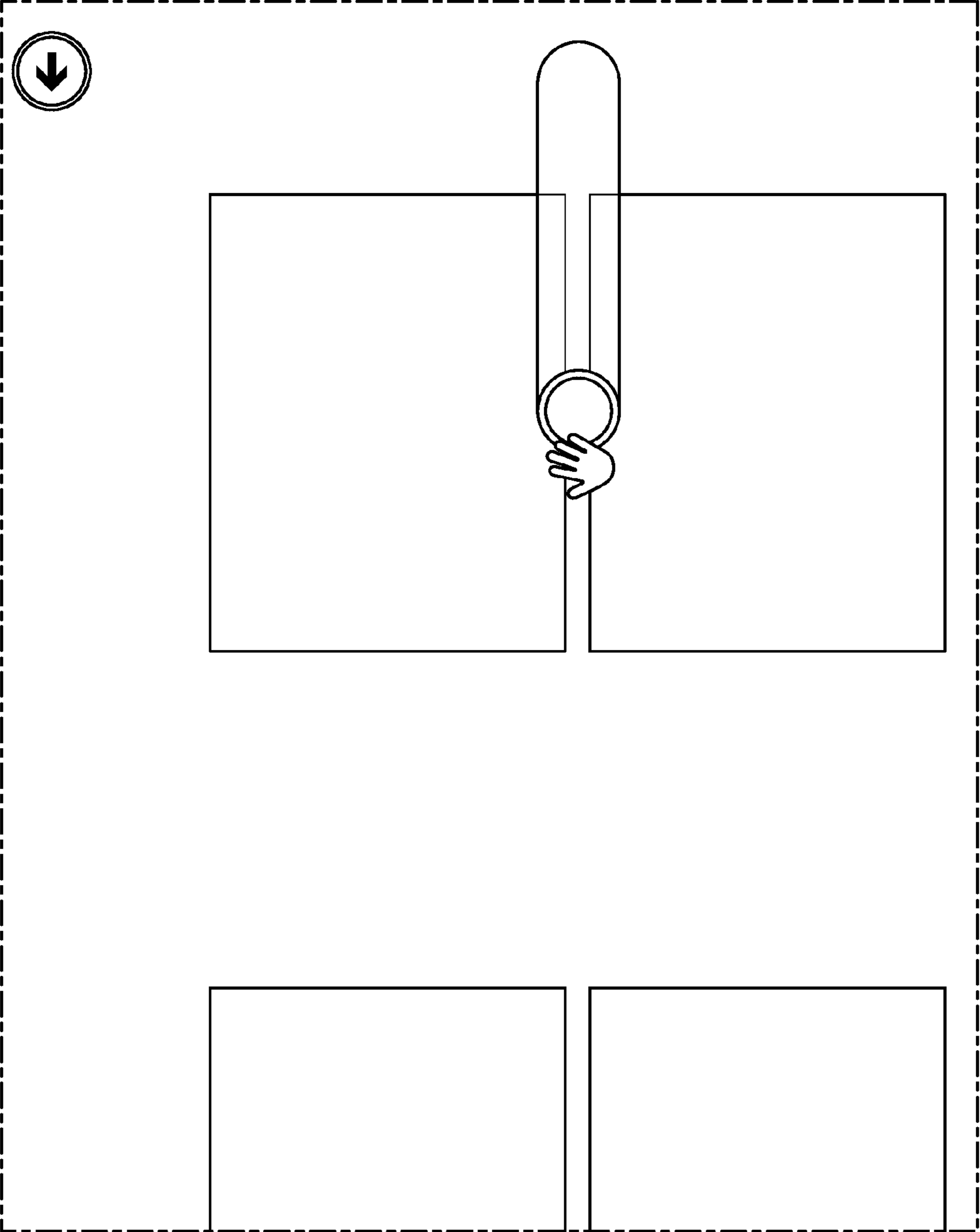

FIG. 3

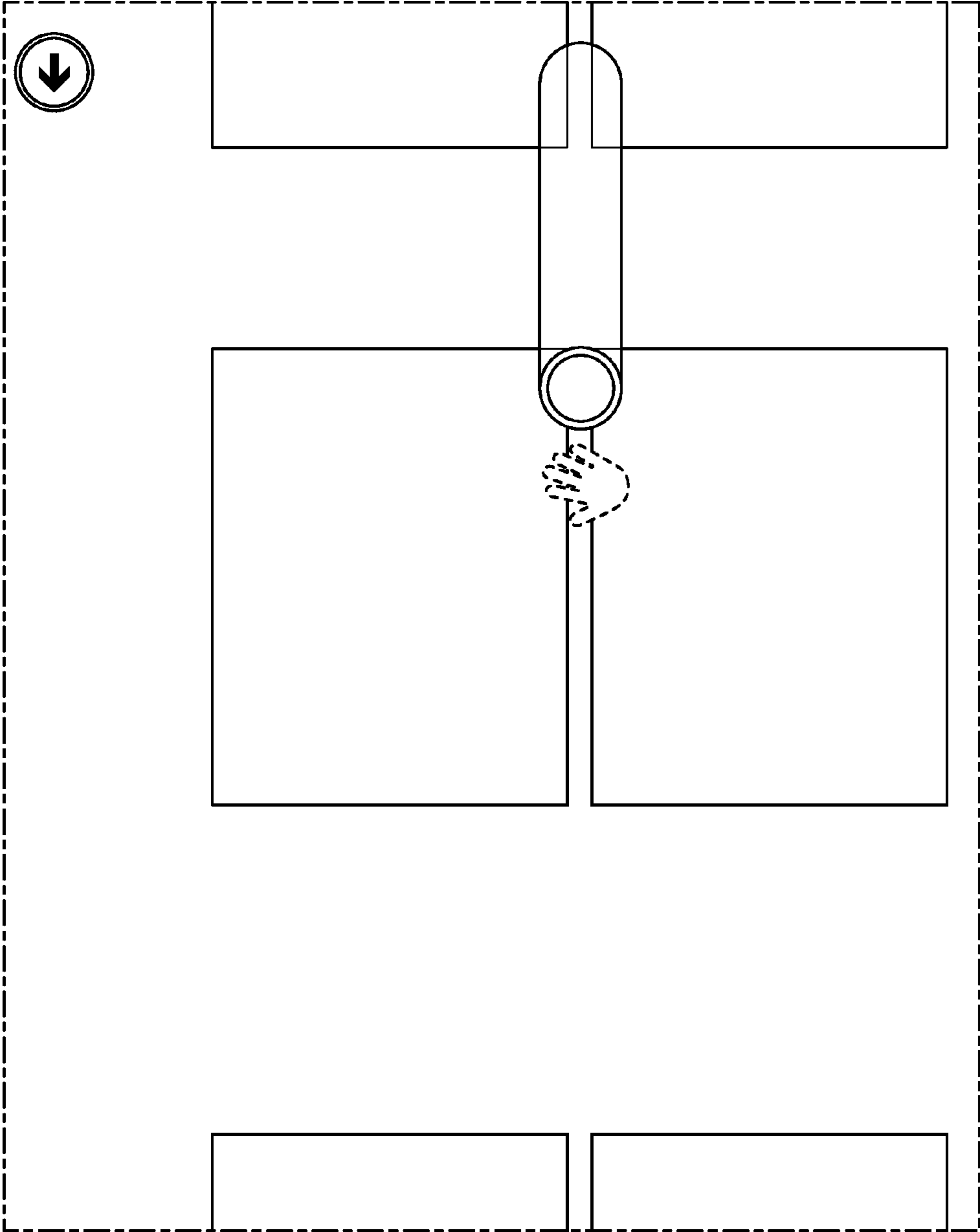

FIG. 4

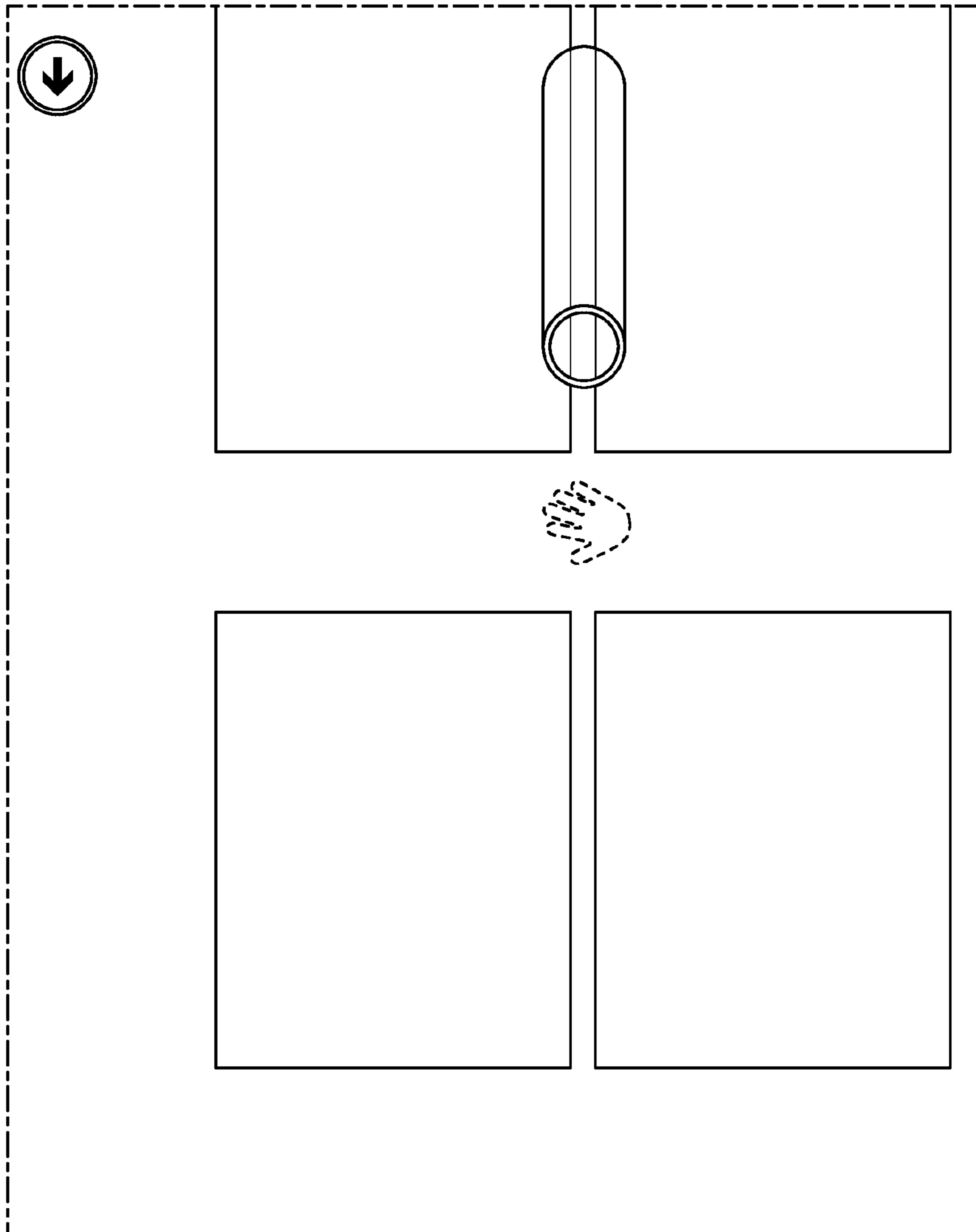

FIG. 5

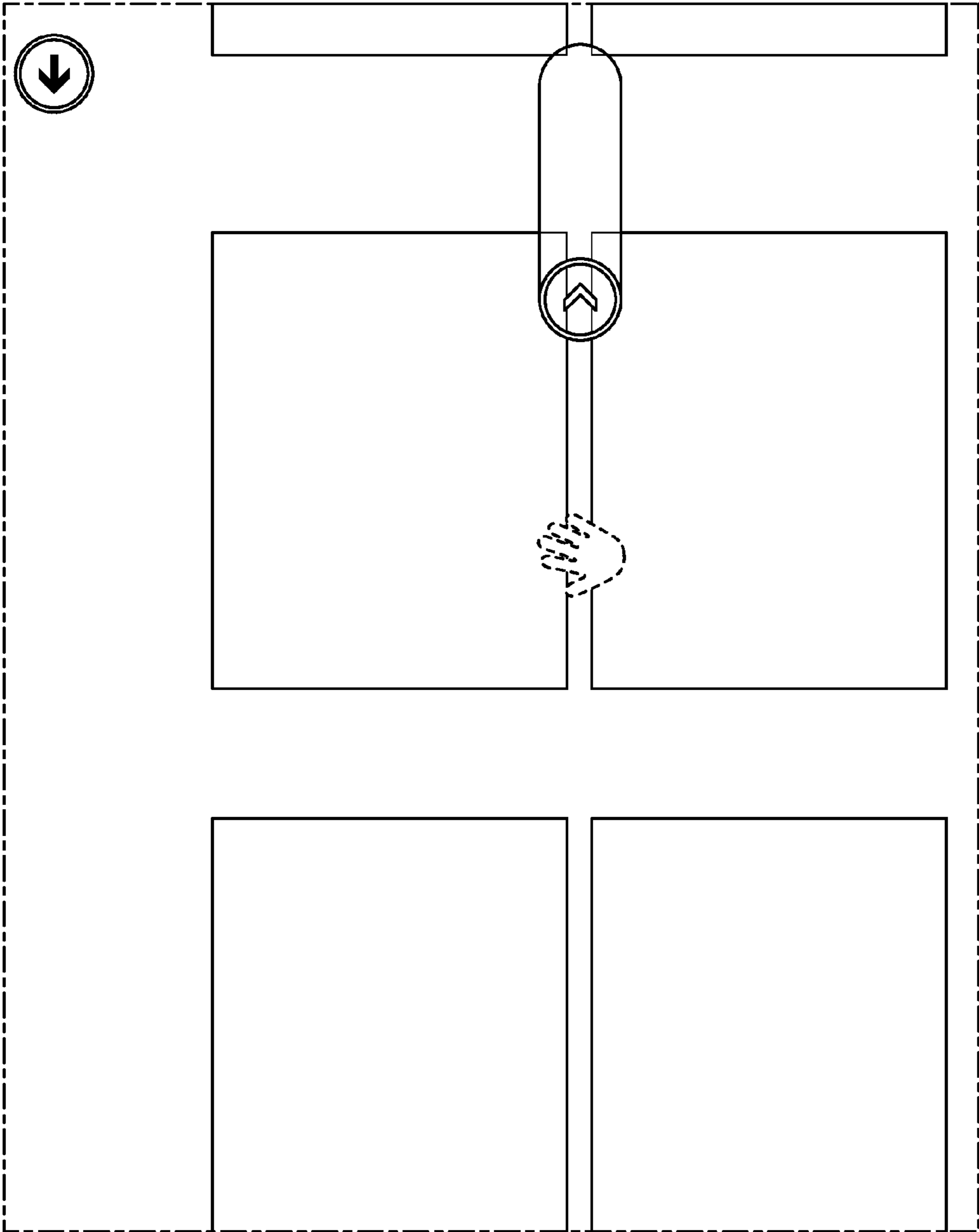

FIG. 6

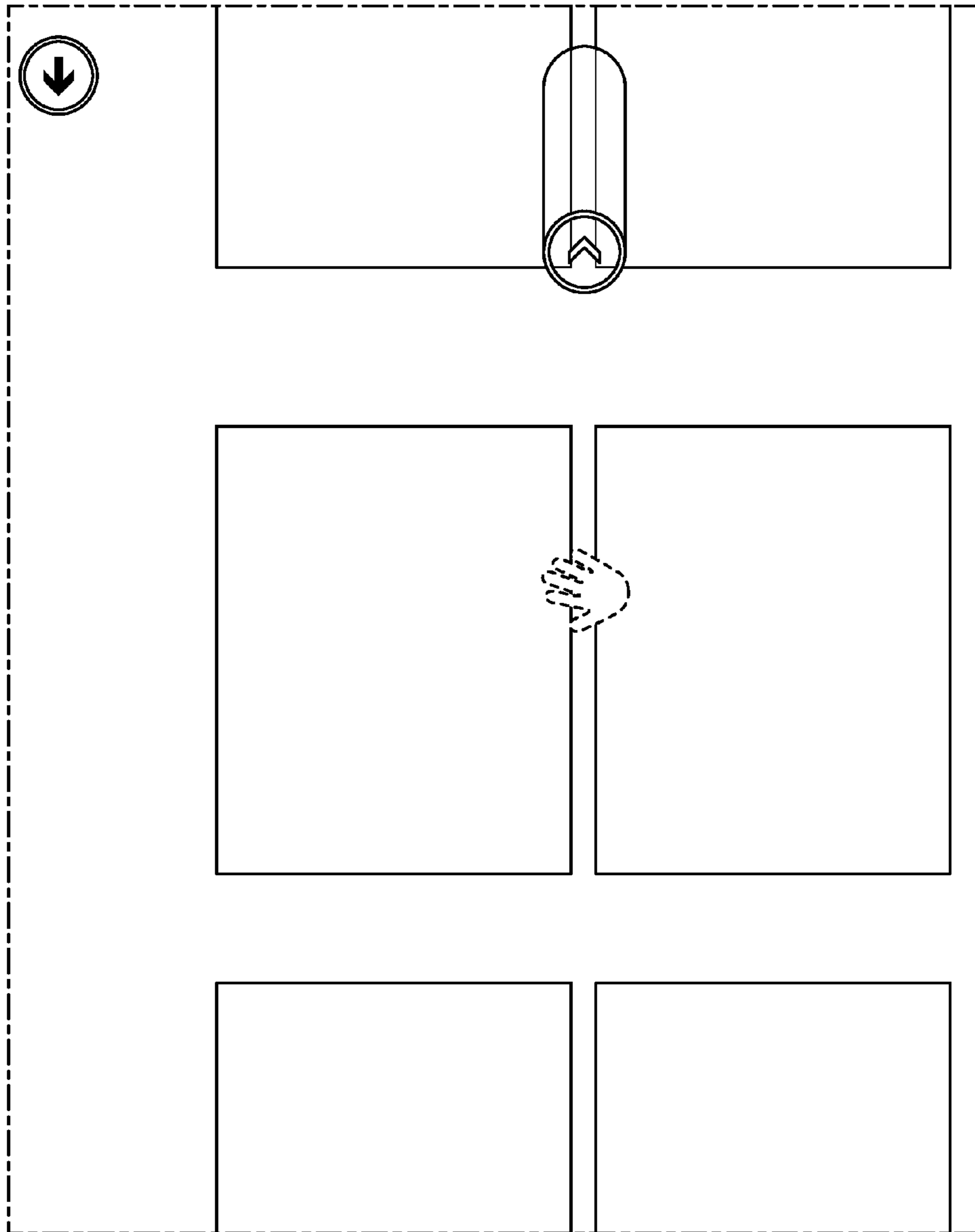

FIG. 7

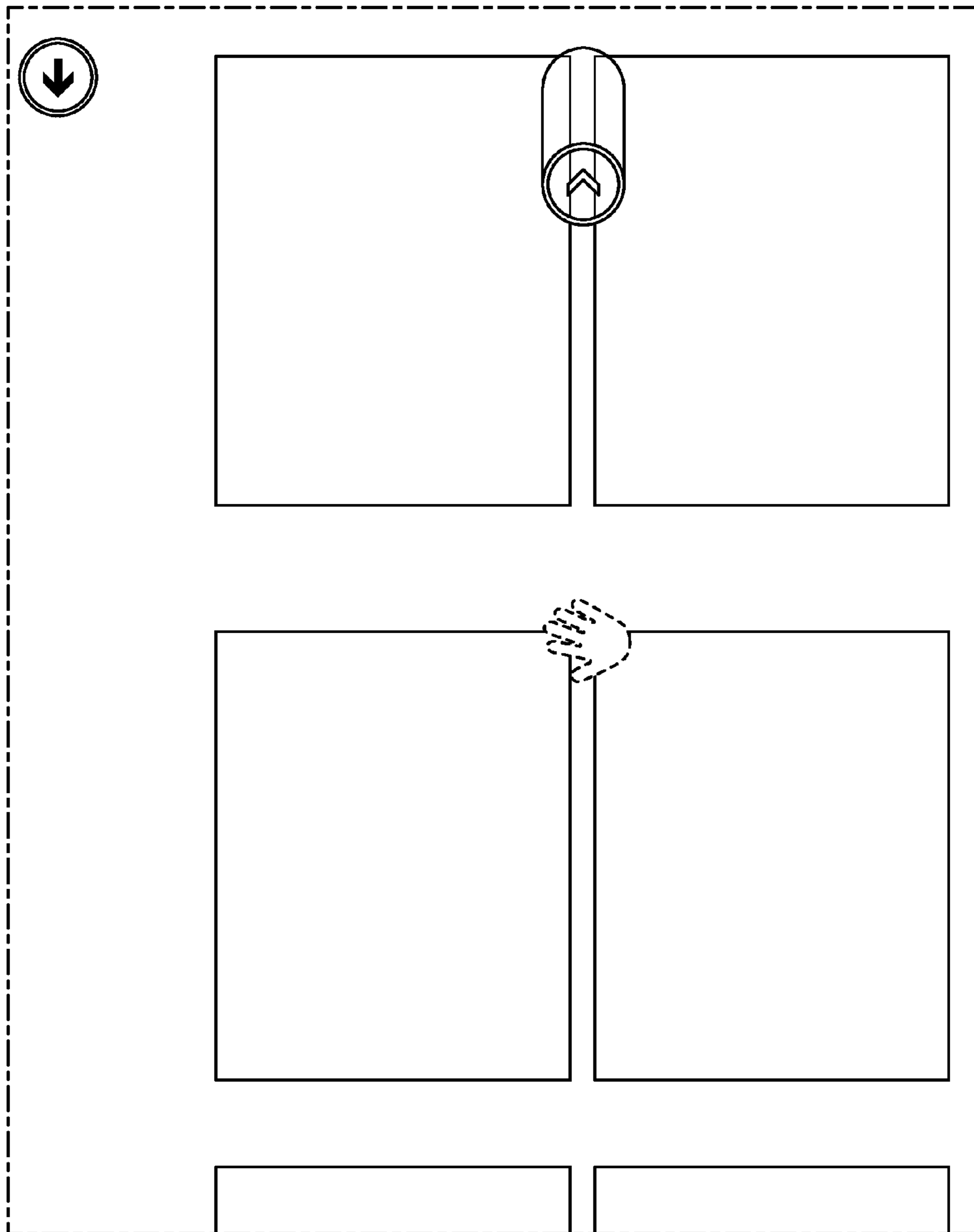

FIG. 8

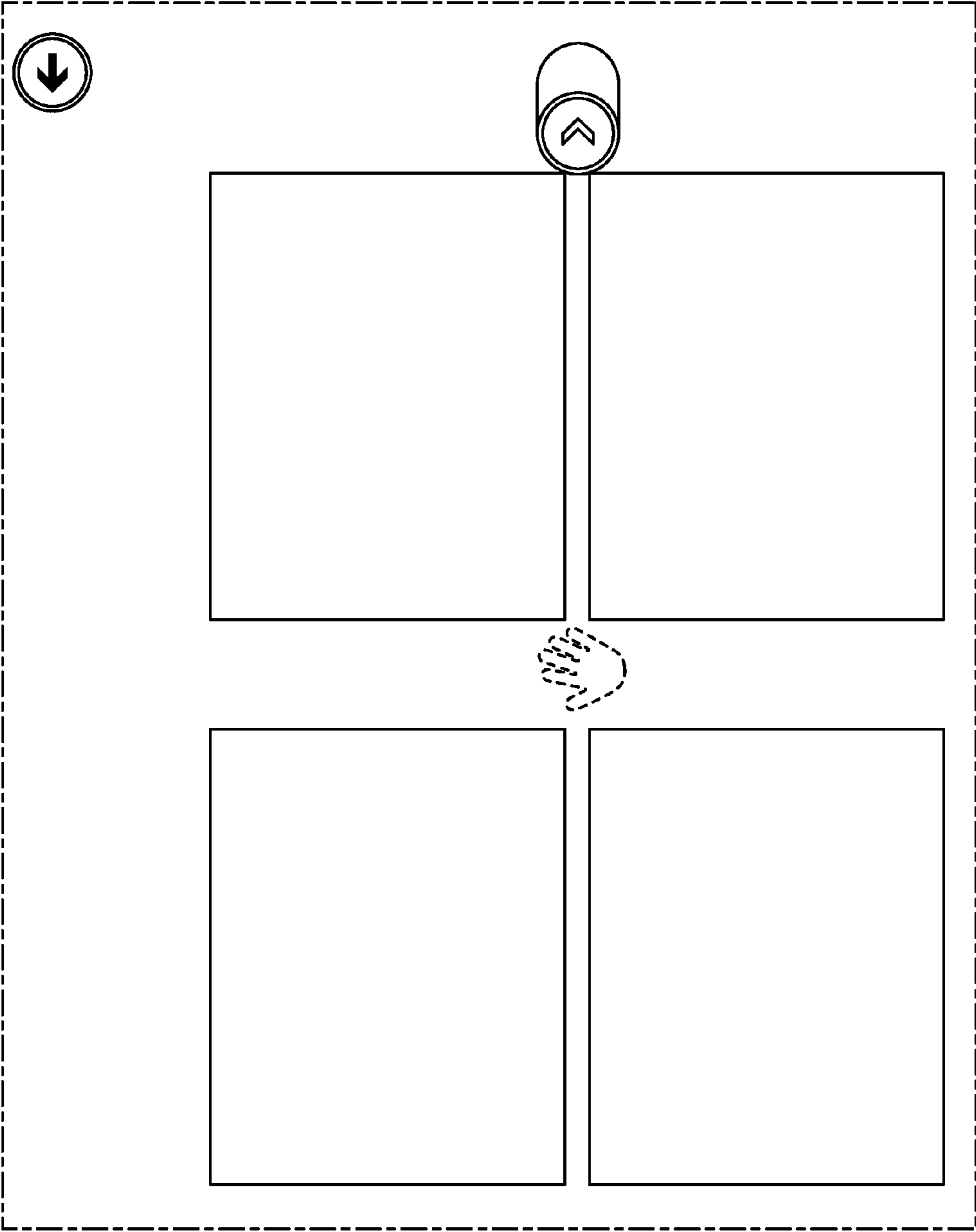

FIG. 9

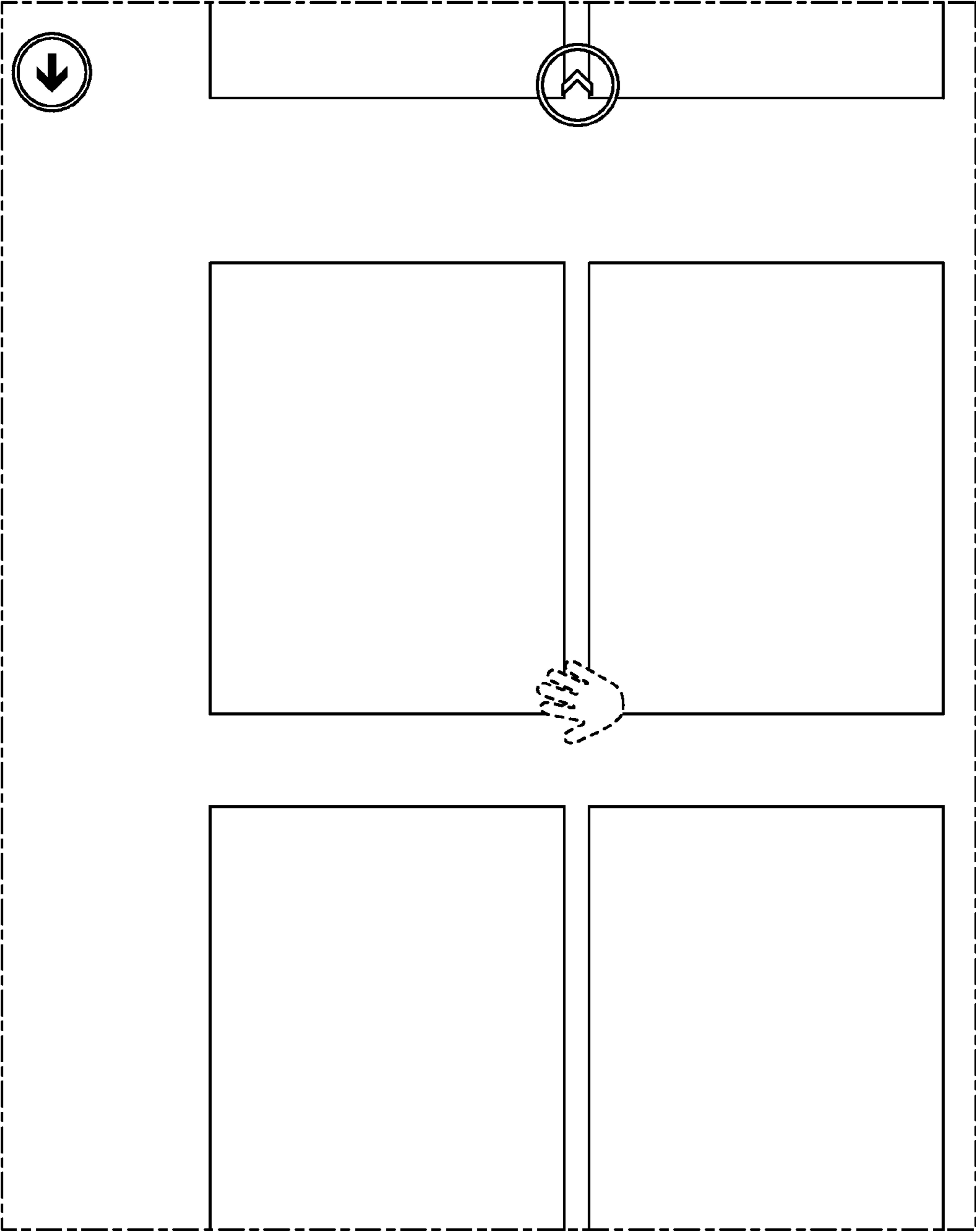

FIG. 10

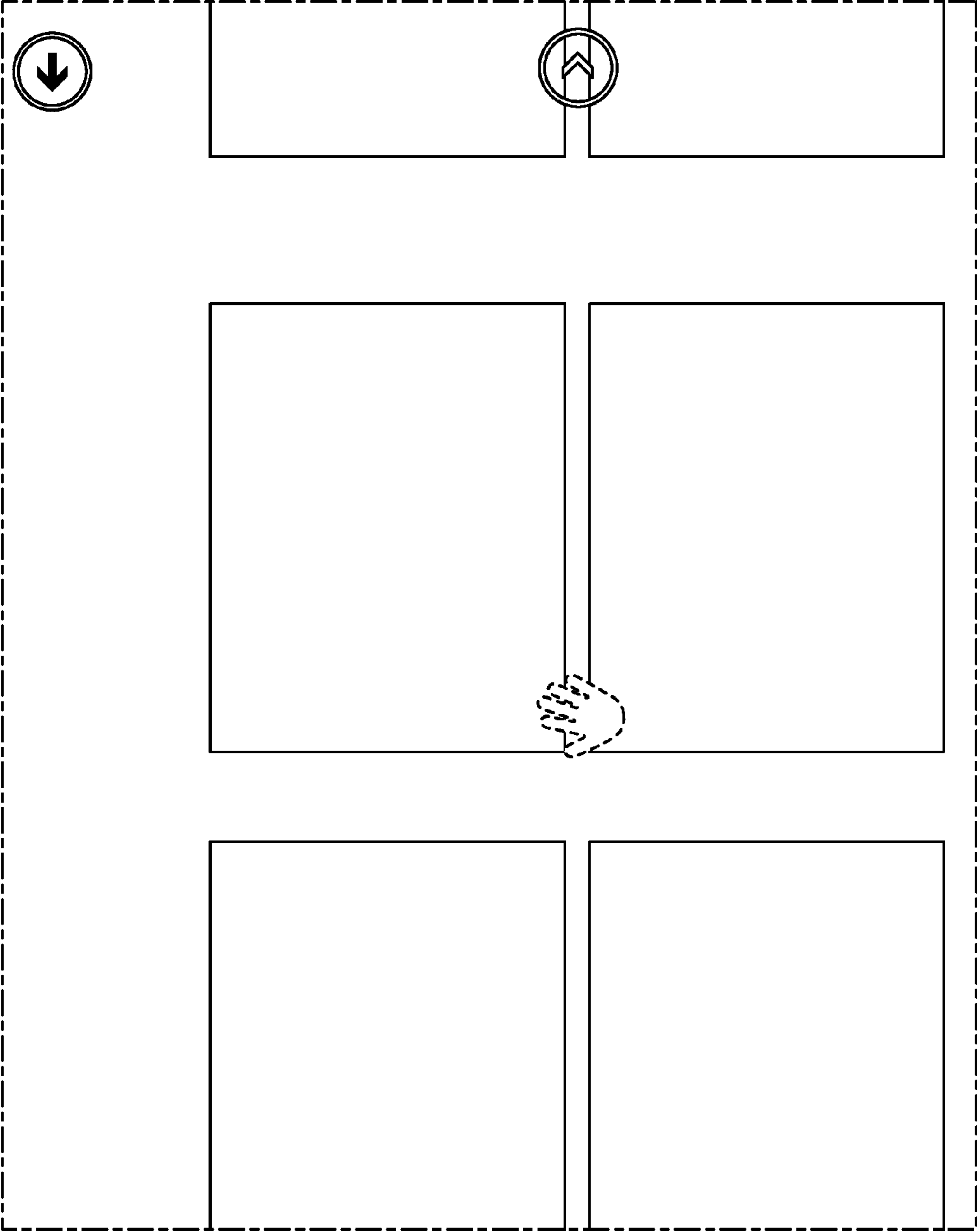

FIG. 11

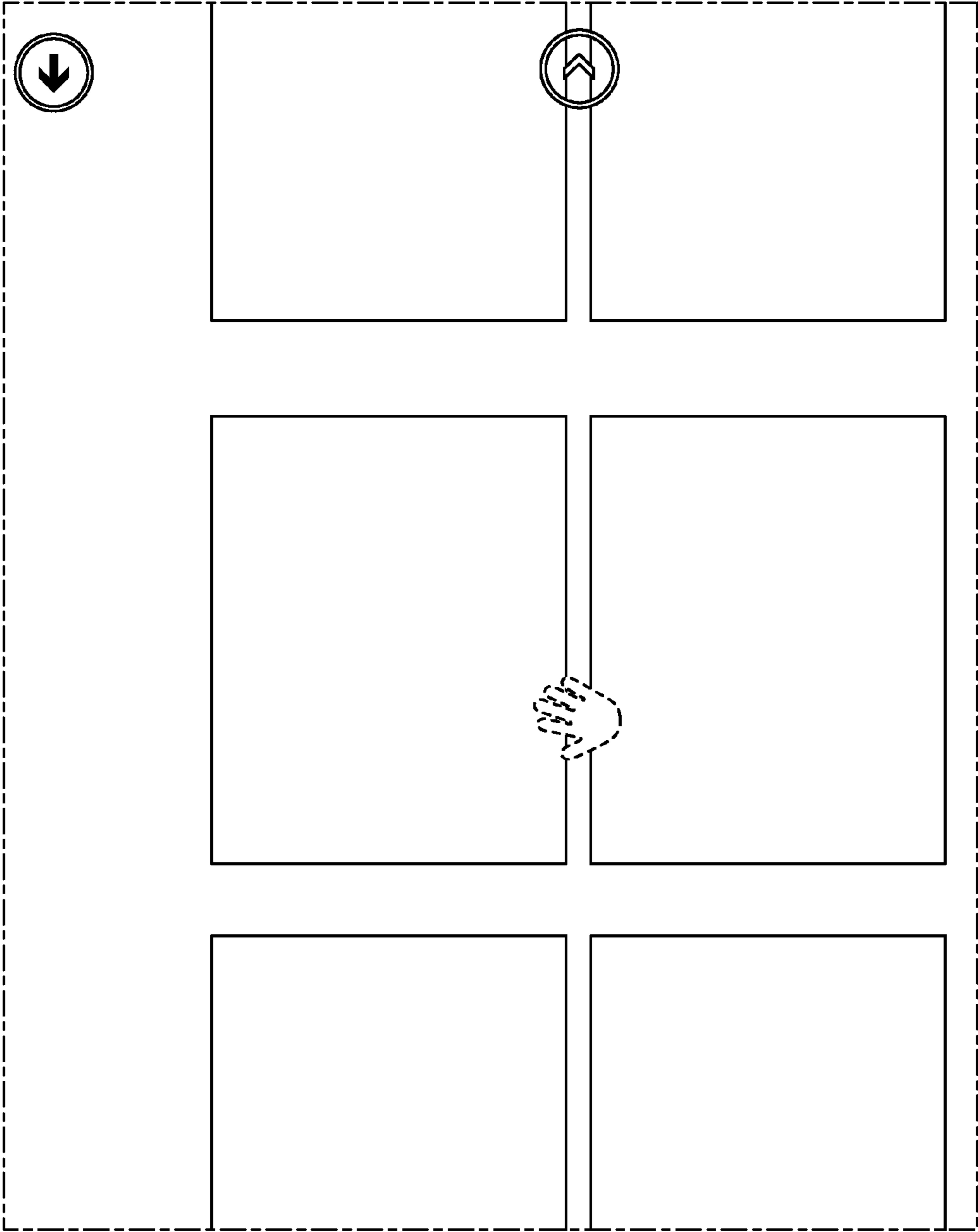

FIG. 12

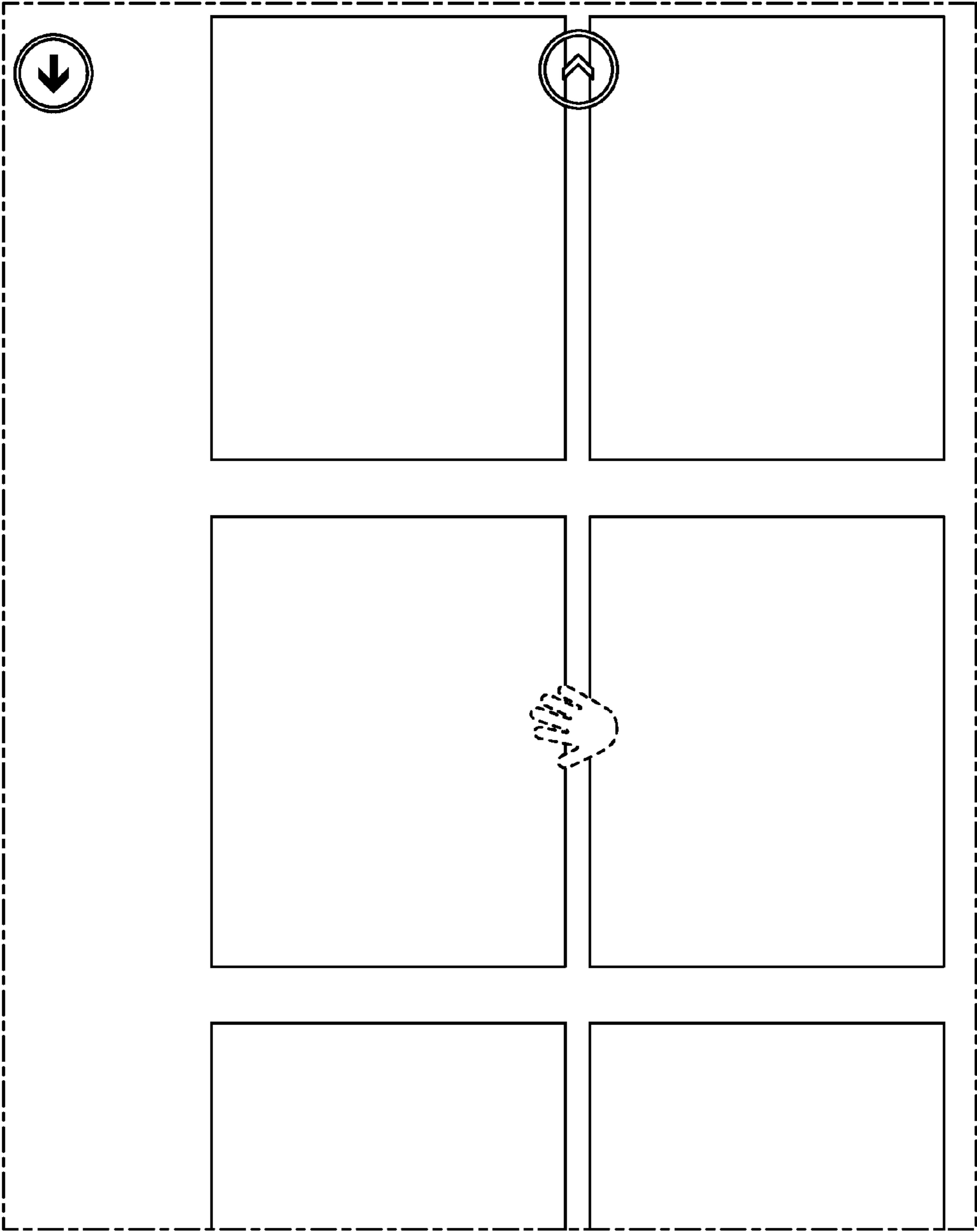

FIG. 13

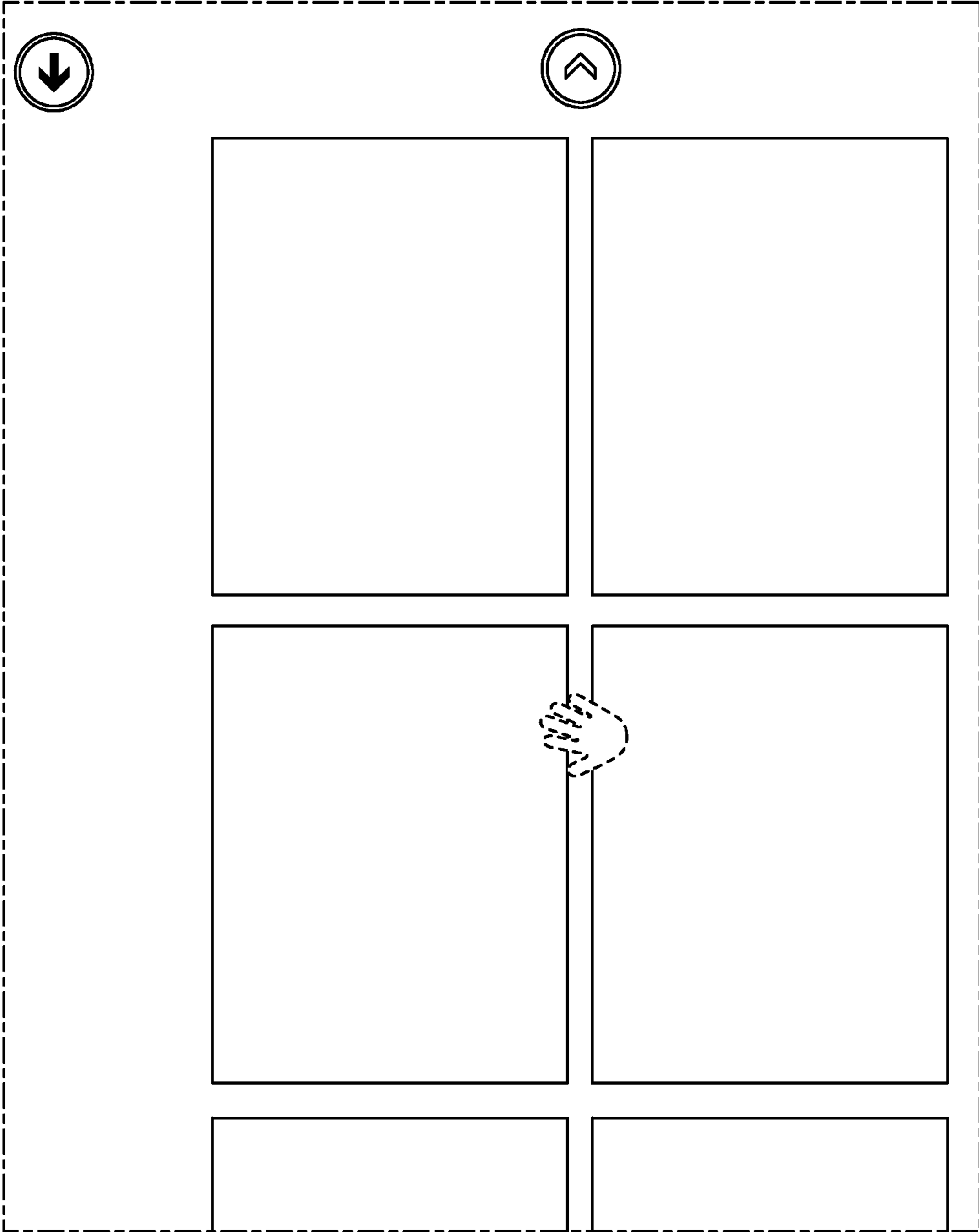

FIG. 14