



US00D641350S

(12) **United States Design Patent**
Drysdale et al.

(10) **Patent No.:** **US D641,350 S**
(45) **Date of Patent:** **** Jul. 12, 2011**

(54) **BASE FOR A PORTABLE MEDICAL DEVICE OR LAPTOP**

(75) Inventors: **Ian George Moir Drysdale**, Inverness (GB); **David Morris Williams**, Wirral (GB)

(73) Assignee: **DanMedical Ltd.**, Inverness (GB)

(**) Term: **14 Years**

(21) Appl. No.: **29/363,864**

(22) Filed: **Jun. 15, 2010**

(30) **Foreign Application Priority Data**

Dec. 19, 2009 (GB) 4013832

(51) **LOC (9) Cl.** **14-02**

(52) **U.S. Cl.** **D14/315; D14/434**

(58) **Field of Classification Search** D14/230, D14/240, 300, 315-327, 356, 358, 433, 434; D13/103, 123, 152, 162, 184, 199; D24/185, D24/186; 361/679.02, 679.08, 679.09, 679.27, 361/679.55, 679.58; 455/521, 522; 600/300, 600/437, 443, 459; 345/30

See application file for complete search history.

(56) **References Cited**

U.S. PATENT DOCUMENTS

5,459,388 A * 10/1995 Illingworth et al. 429/7
D365,336 S * 12/1995 Vossoughi et al. D14/322
5,818,690 A * 10/1998 Spencer 361/679.09

6,049,450 A * 4/2000 Cho et al. 361/679.27
6,274,266 B1 * 8/2001 Wang 429/163
6,580,948 B2 * 6/2003 Hauptert et al. 607/60
6,617,063 B1 * 9/2003 Ohnishi 429/7
6,695,777 B2 * 2/2004 Solomon et al. 600/437
6,757,159 B2 * 6/2004 Zarek et al. 361/679.09
6,894,894 B2 * 5/2005 Zarek et al. 361/679.08
7,199,999 B2 * 4/2007 Shin et al. 361/679.55
2009/0186647 A1 * 7/2009 Smart et al. 455/521

* cited by examiner

Primary Examiner — Freda Nunn

(74) *Attorney, Agent, or Firm* — Plumsea Law Group, LLC

(57) **CLAIM**

The ornamental design for a base for a portable medical device or laptop, as shown and described.

DESCRIPTION

FIG. 1 is a front elevational view of a base for a portable medical device or laptop showing our new design; FIG. 2 is a rear elevational view thereof; FIG. 3 is a side elevational view of the left side thereof; FIG. 4 is a side elevational view of the right side thereof; FIG. 5 is a left frontal perspective view thereof; FIG. 6 is a right frontal perspective view thereof; FIG. 7 is a left rear perspective view thereof; FIG. 8 is a left bottom perspective view thereof; FIG. 9 is a right rear perspective view thereof; and, FIG. 10 is a right bottom perspective view thereof.

The broken line showings of the connectors, ports, controllers, indicators within the claimed design, and the remainder of the device or laptop form no part of the claimed design.

1 Claim, 4 Drawing Sheets

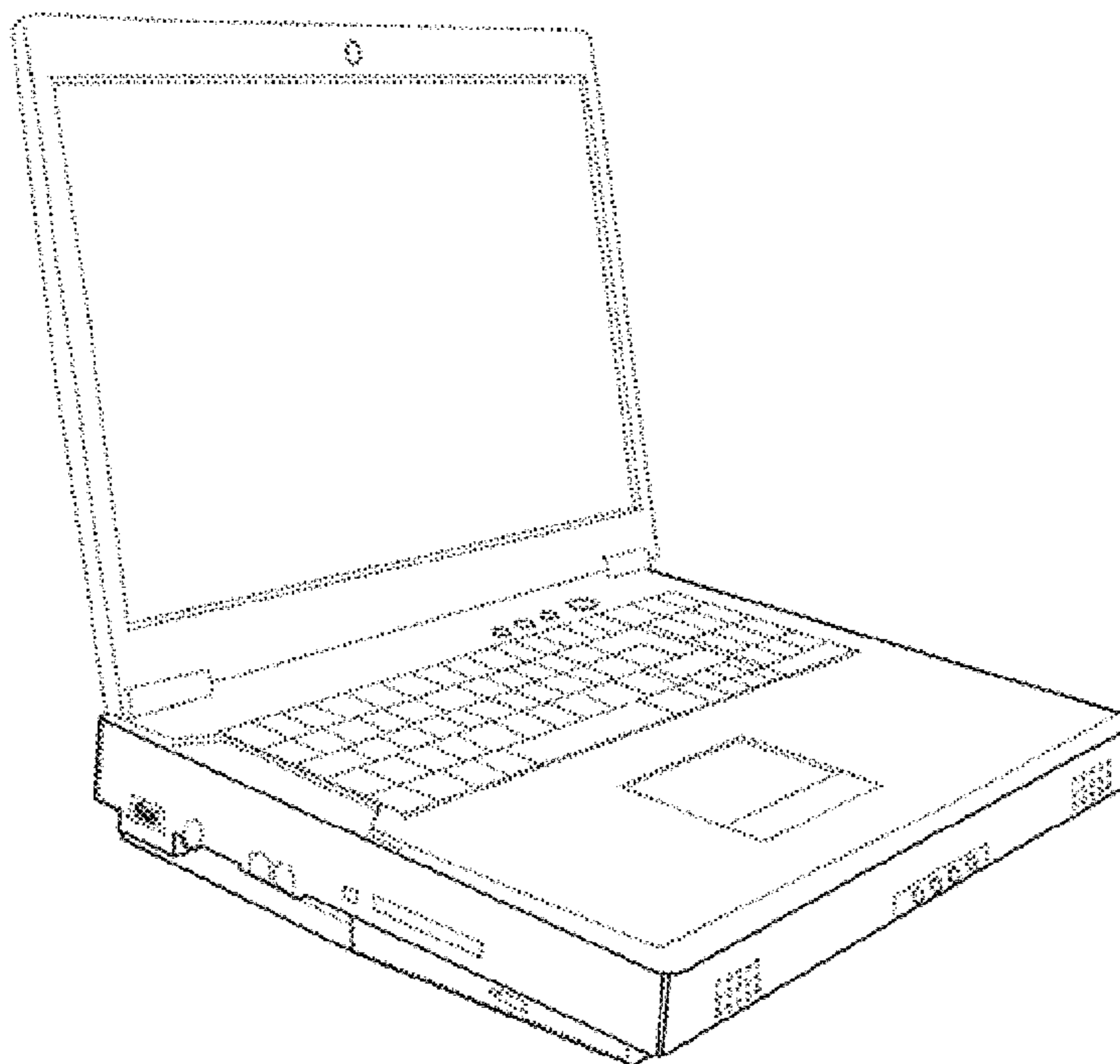

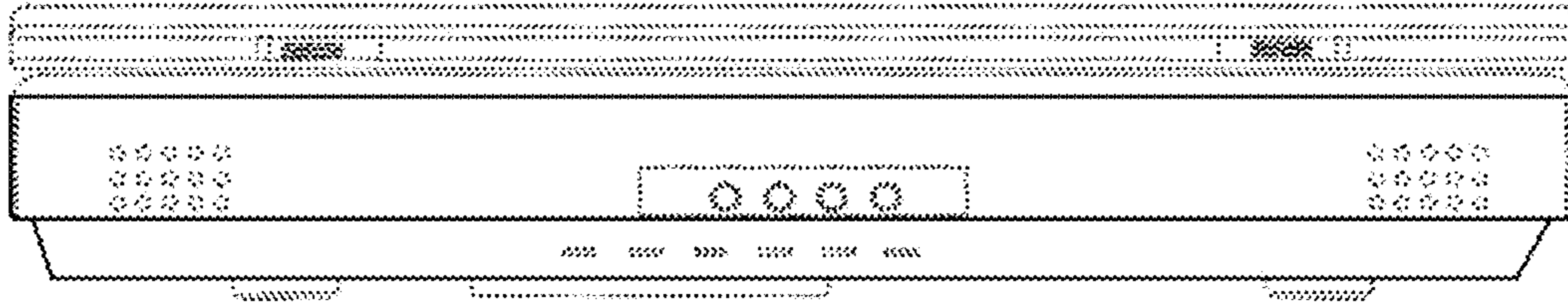

FIG. 1

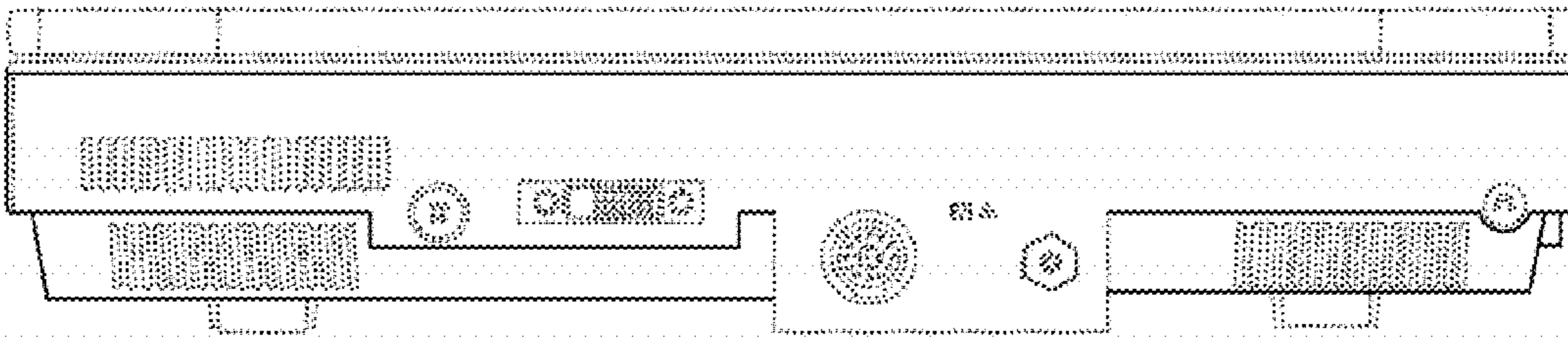

FIG. 2

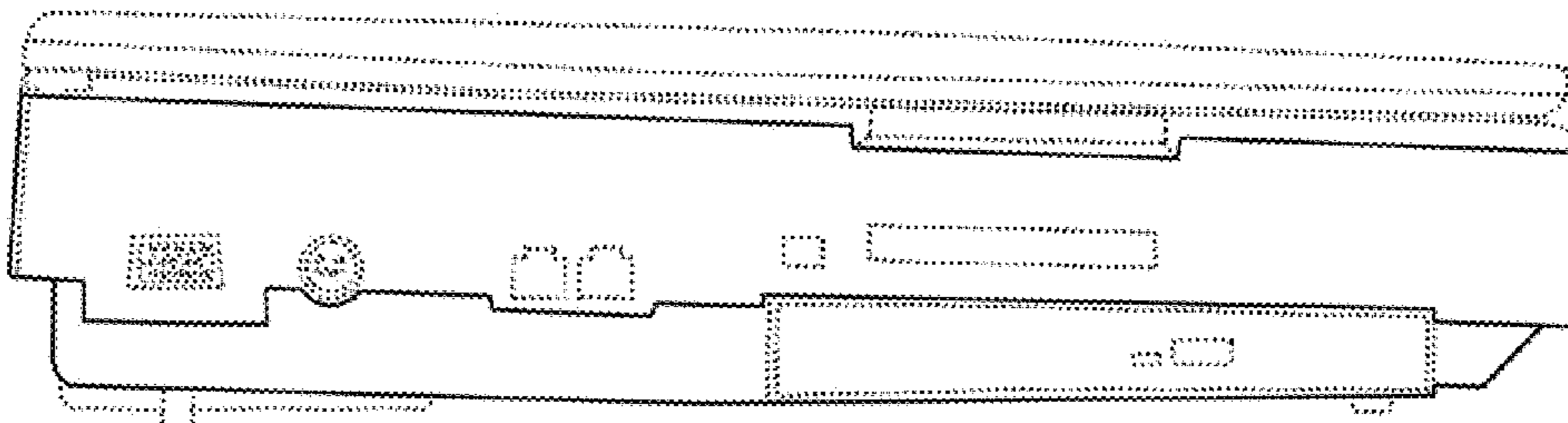

FIG. 3

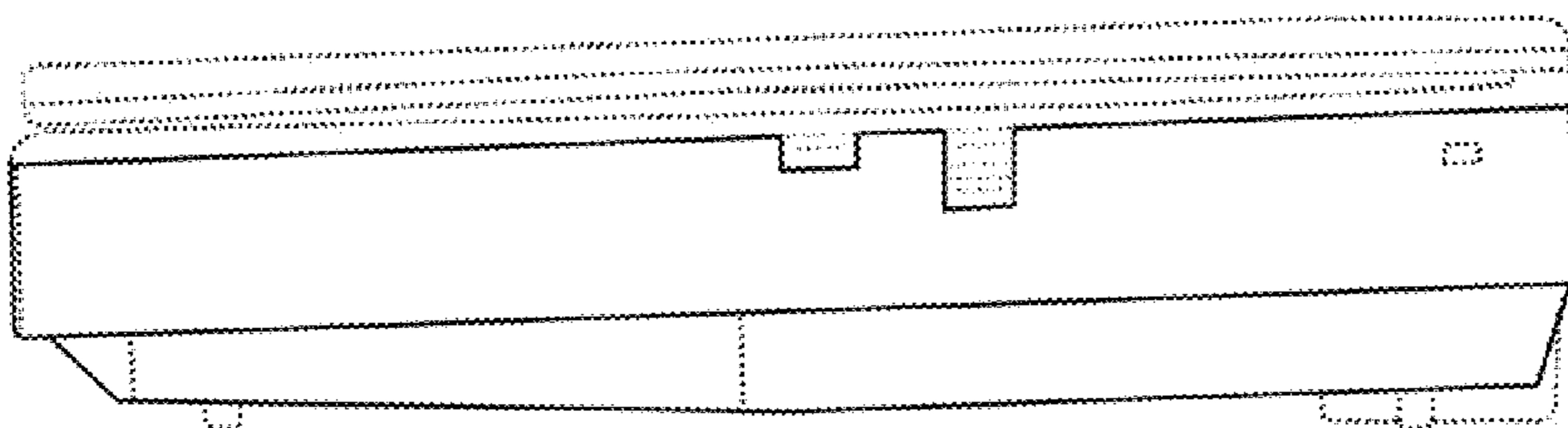

FIG. 4

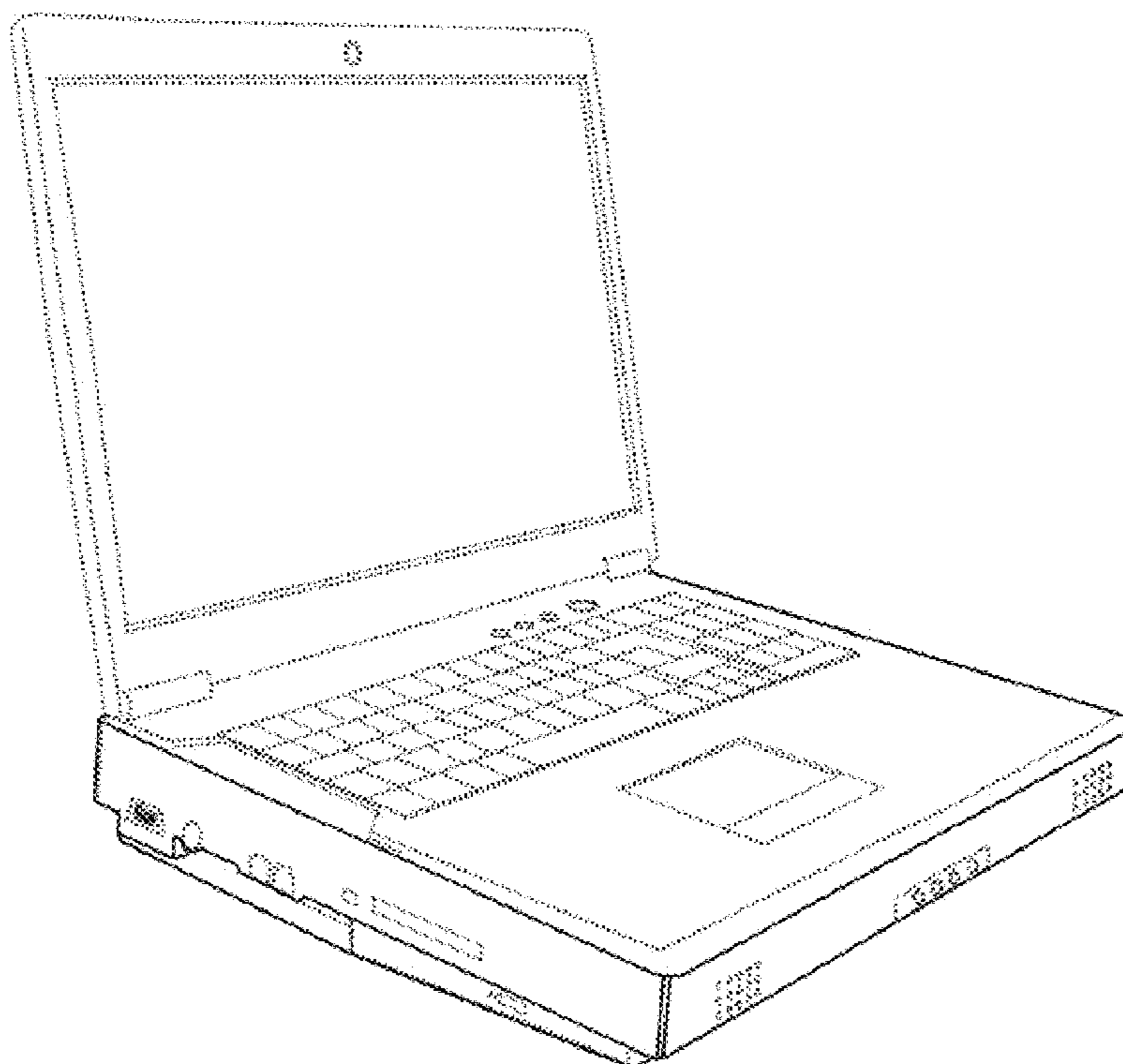

FIG. 5

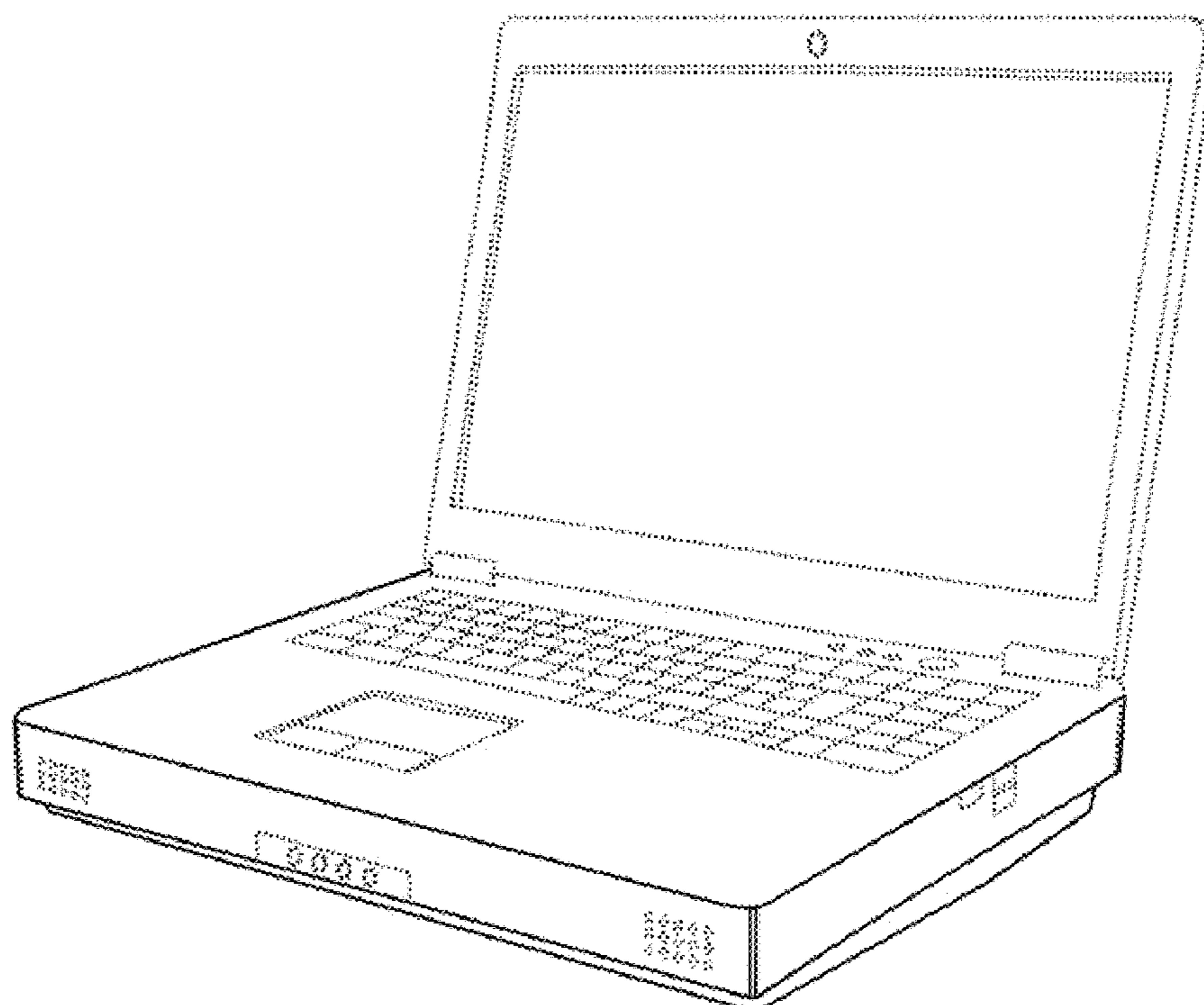

FIG. 6

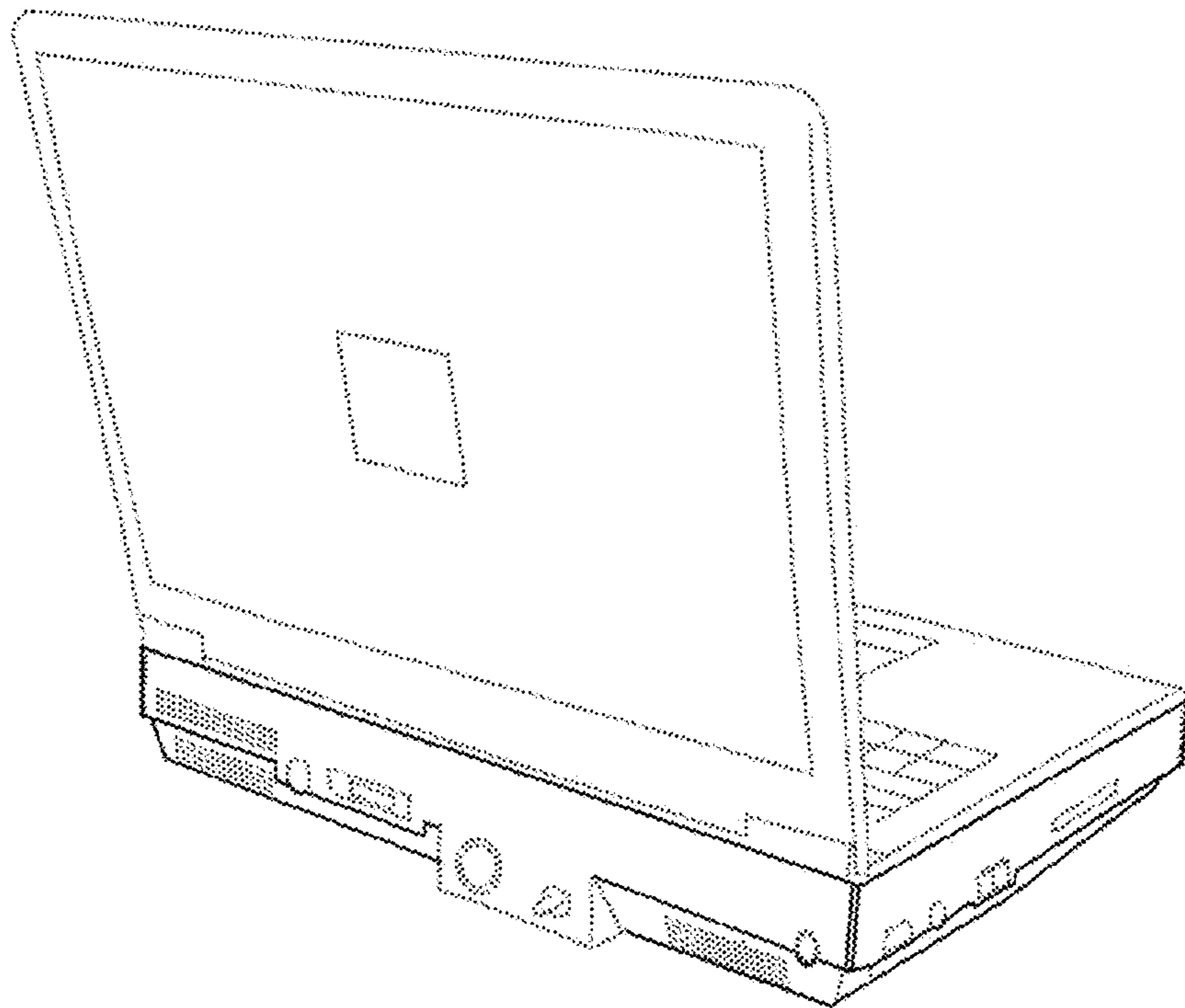

FIG. 7

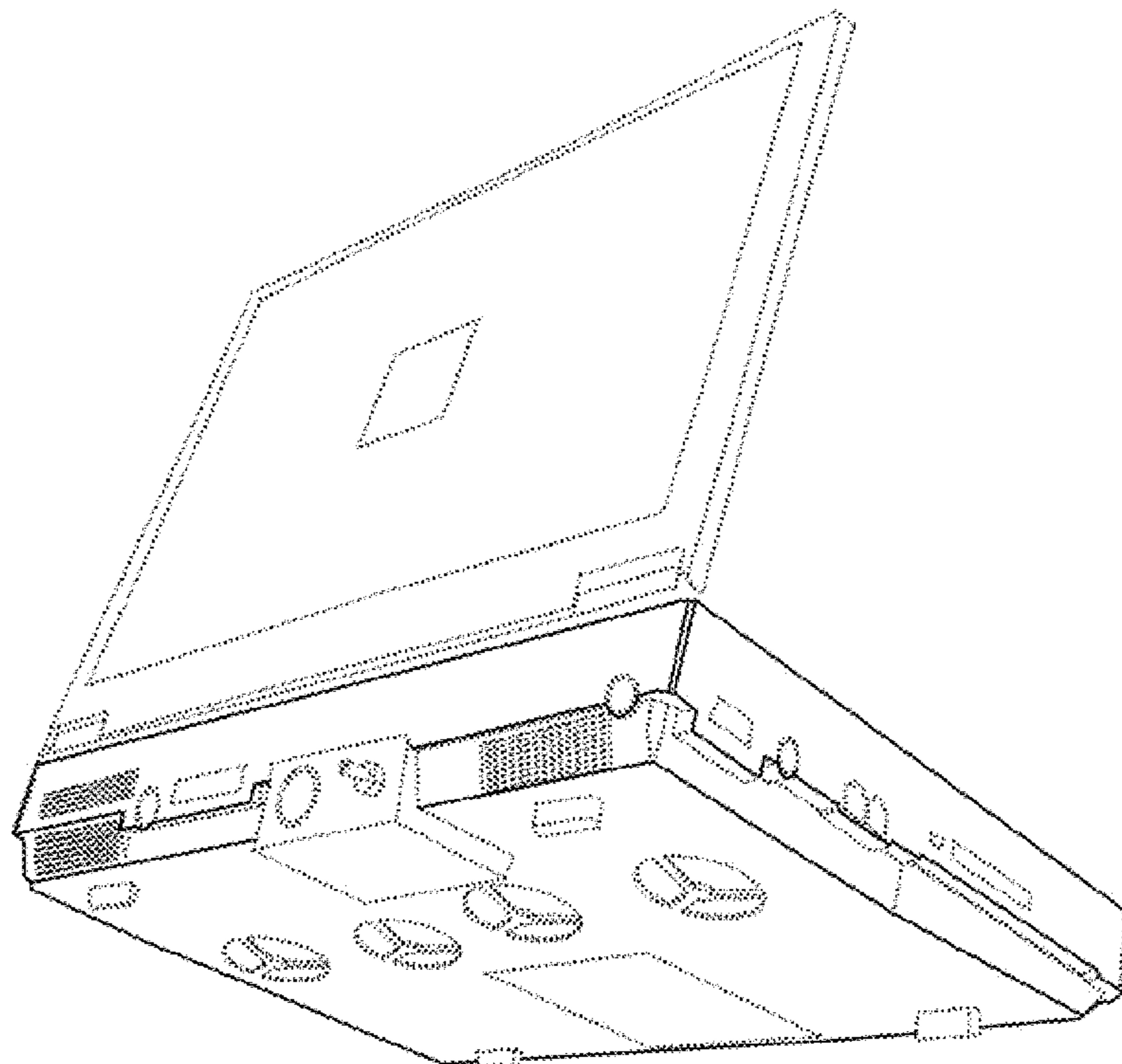

FIG. 8

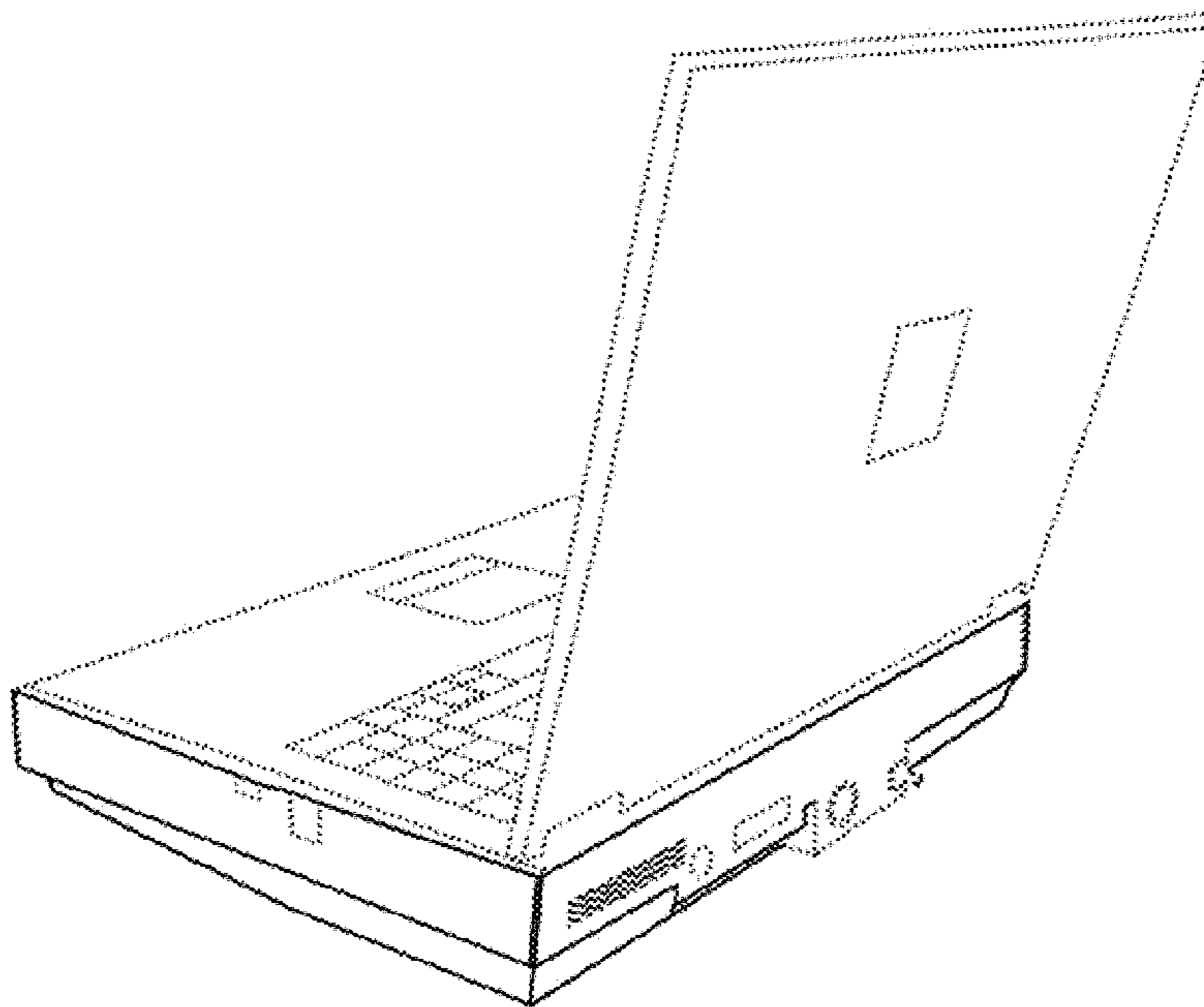

FIG. 9

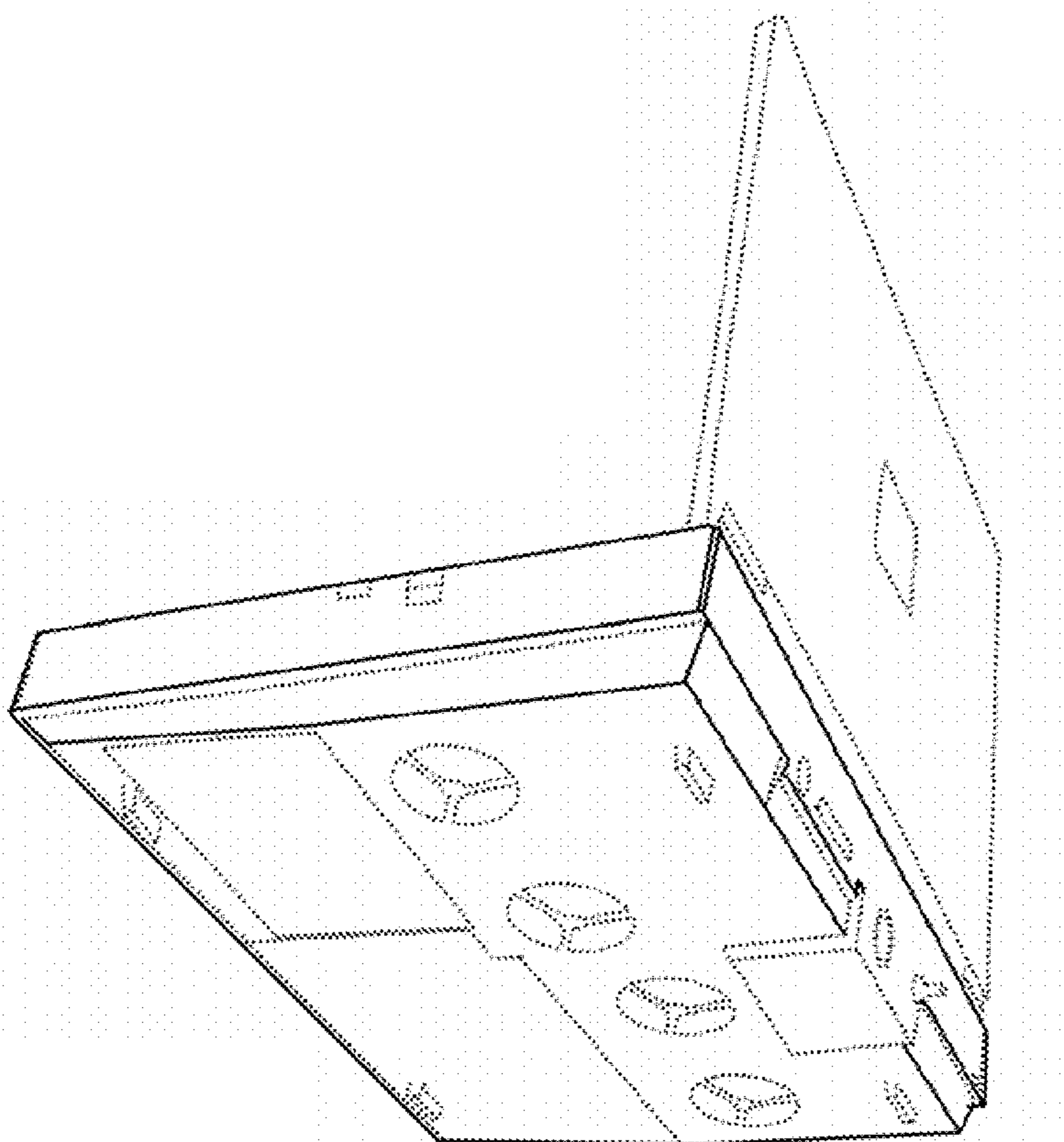

FIG. 10