



US00D641348S

(12) **United States Design Patent**
Kim et al.

(10) **Patent No.:** **US D641,348 S**
(45) **Date of Patent:** **** Jul. 12, 2011**

(54) **MOBILE TERMINAL CASE**

(75) Inventors: **Yoon-Young Kim**, Yongin-Si (KR);
Jin-Soo Kim, Yongin-si (KR);
Seog-Guen Kim, Seoul (KR)

(73) Assignee: **Samsung Electronics Co., Ltd.** (KR)

(**) Term: **14 Years**

(21) Appl. No.: **29/379,737**

(22) Filed: **Nov. 23, 2010**

(30) **Foreign Application Priority Data**

Sep. 30, 2010 (KR) 30-2010-0042612

(51) **LOC (9) Cl.** **14-03**

(52) **U.S. Cl.** **D14/250**

(58) **Field of Classification Search** D14/250-253,
D14/440, 203.7, 217, 496, 203.3; D3/201,
D3/218, 269, 301, 273, 303; D13/103; 220/4.02;
224/191, 240, 241, 245, 682-683; 248/309.1;
361/679.56; 379/426, 433.11, 455; 455/575.1,
455/575.8; 190/100; 206/305, 320
See application file for complete search history.

(56) **References Cited**

U.S. PATENT DOCUMENTS

- D116,977 S * 10/1939 Bellau D3/301
- D144,533 S * 4/1946 Worley D3/295
- 4,718,550 A * 1/1988 Johnson 206/387.13
- D317,977 S * 7/1991 Felkner et al. D3/299
- 5,145,068 A * 9/1992 Schmitz et al. 206/472
- D414,033 S * 9/1999 Rohm D3/249
- D423,273 S * 4/2000 Sankey et al. D6/632
- D435,550 S * 12/2000 Chu et al. D14/345
- D462,518 S * 9/2002 Truffier-Blanc et al. D3/273
- D519,275 S * 4/2006 Shertzer D3/218
- D551,846 S * 10/2007 Ko et al. D3/201
- D557,495 S * 12/2007 Chan et al. D3/218

- D557,894 S * 12/2007 Yeo et al. D3/218
- D558,973 S * 1/2008 Hussaini et al. D3/201
- D559,267 S * 1/2008 Griffin et al. D14/496
- D567,500 S * 4/2008 Kwak et al. D3/218

(Continued)

OTHER PUBLICATIONS

Review of United SGP Vintage Edition Leather Case for Apple iPad, review published Apr. 26, 2010, <URL:http://www.ilounge.com/index.php/reviews/entry/united-sgp-vintage-edition-leather-case-for-apple-ipad/>, retrieved from internet Mar. 21, 2011.*

(Continued)

Primary Examiner — Rob Spear
Assistant Examiner — Carla Wright
(74) *Attorney, Agent, or Firm* — NSIP Law

(57) **CLAIM**

The ornamental design for a mobile terminal case, as shown and described.

DESCRIPTION

FIG. 1 is a perspective view of a mobile terminal case;
FIG. 2 is a front view of the mobile terminal case of FIG. 1;
FIG. 3 is a rear view of the mobile terminal case of FIG. 1;
FIG. 4 is a left-side view of the mobile terminal case of FIG. 1;
FIG. 5 is a right-side view of the mobile terminal case of FIG. 1;
FIG. 6 is a top plan view of the mobile terminal case of FIG. 1; and
FIG. 7 is a bottom plan view of the mobile terminal case of FIG. 1; and,
FIG. 8 is a perspective view of the mobile terminal case, shown with an environmental mobile terminal in broken lines.
The broken line drawing of a mobile terminal is for illustrative purpose only and forms no part of the claimed design.

1 Claim, 6 Drawing Sheets

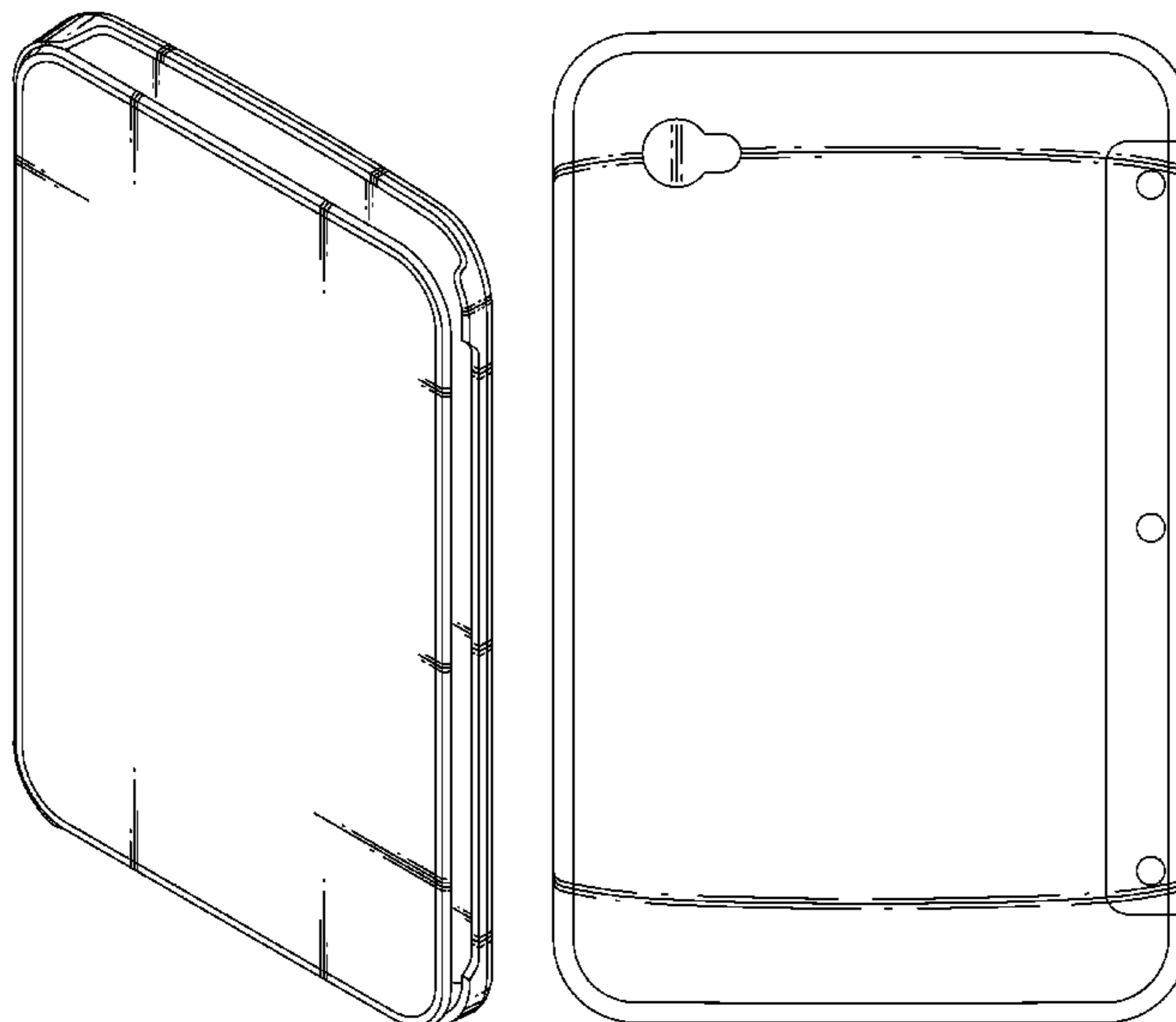

US D641,348 S

Page 2

U.S. PATENT DOCUMENTS

D570,598 S * 6/2008 Chan D3/218
D582,405 S * 12/2008 Andre et al. D3/299
D601,959 S * 10/2009 Lee et al. D13/119
D615,299 S * 5/2010 Agarwal et al. D3/269
D621,396 S * 8/2010 Lee et al. D14/252
D623,052 S * 9/2010 Giraud et al. D9/420
D623,053 S * 9/2010 Giraud et al. D9/420
D624,304 S * 9/2010 Danze et al. D3/201
D628,374 S * 12/2010 Lee et al. D3/201
2008/0053770 A1* 3/2008 Tynyk 190/100

OTHER PUBLICATIONS

SGP iPad 3G Wifi Leather Case Vintage Edition Series, <URL:<http://www.sgpstore.com/tablets/apple/ipad/sgp-ipad-3g-wifi-leather-case-vintage-edition-series.html>>, retrieved from internet Mar. 21, 2011.*
Luxury Convertible Carbon Flip Case for Samsung Galaxy Tab, <URL:<http://www.amazon.com/Luxury-Convertible-Carbon-Samsung-Galaxy/dp/B004GIWN34>>, retrieved from internet Mar. 21, 2011.*

* cited by examiner

FIG. 1

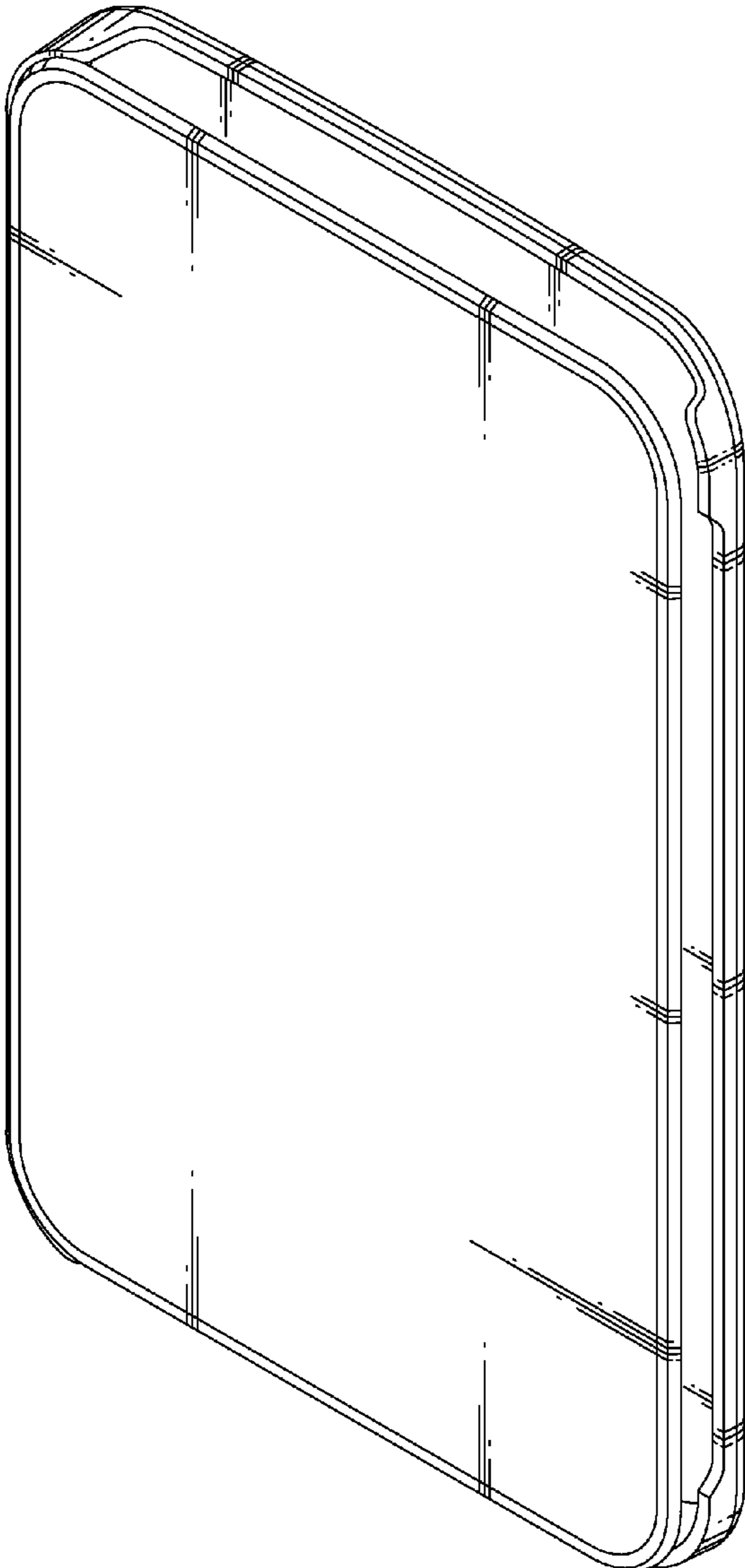

FIG. 2

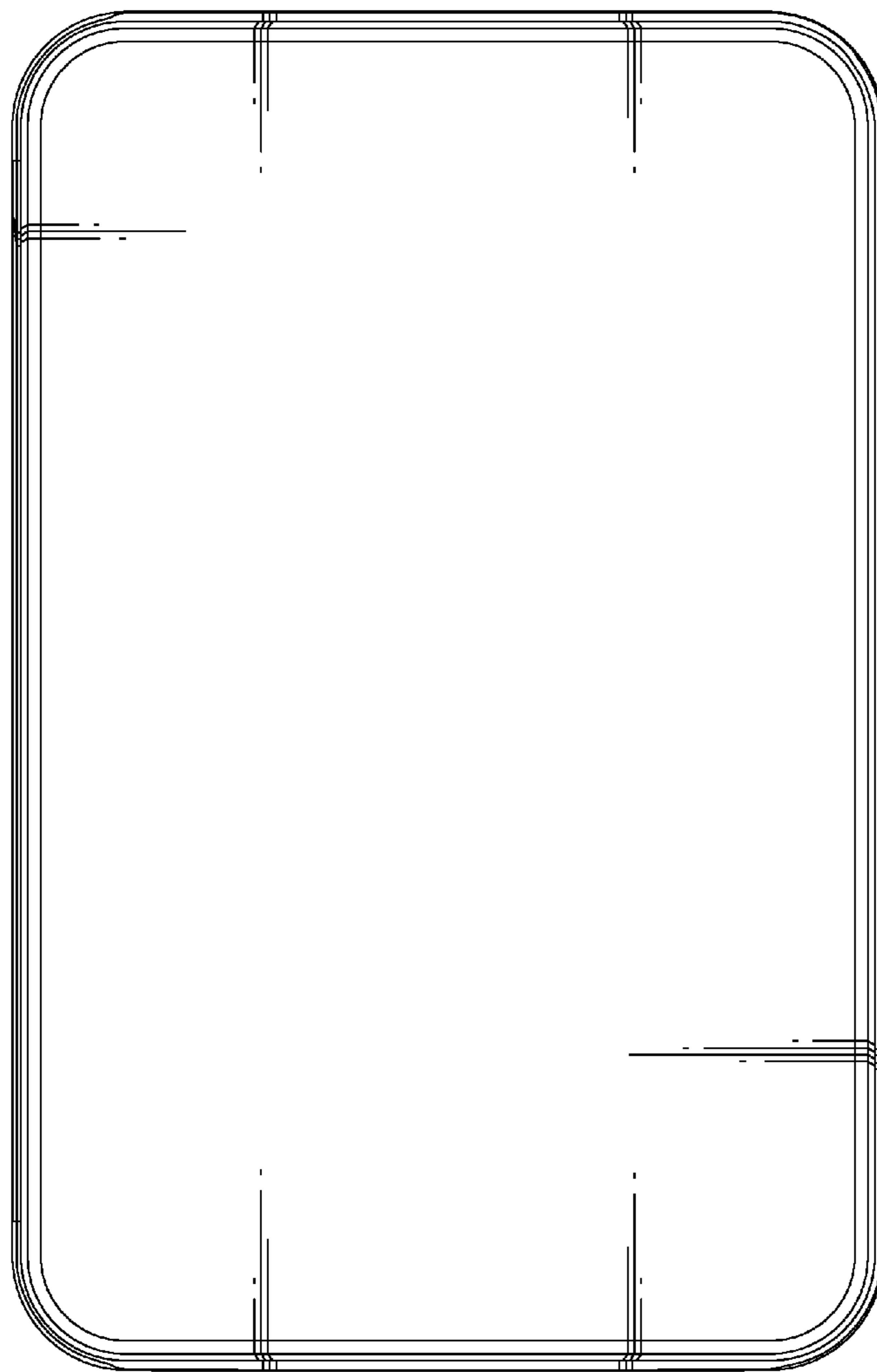

FIG. 3

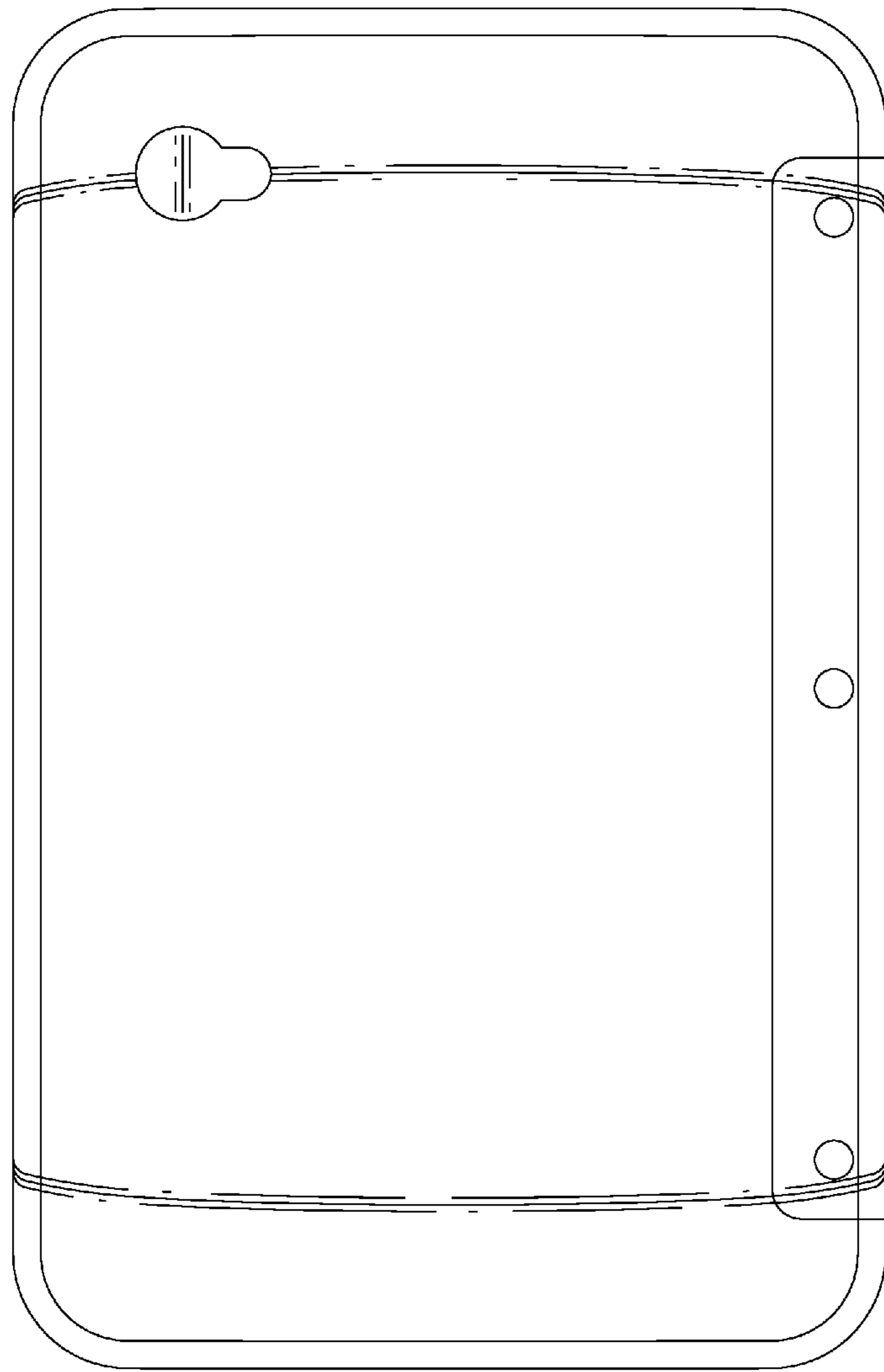

FIG. 4

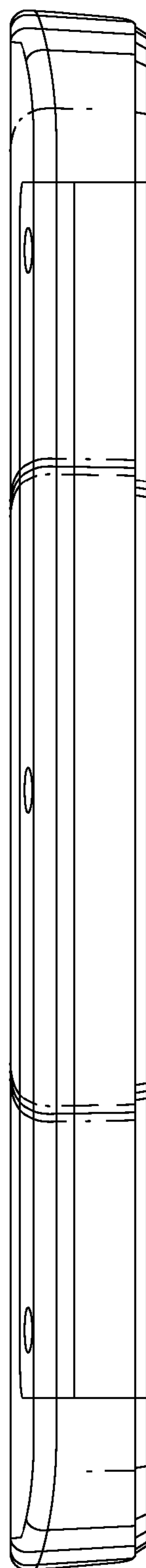

FIG. 5

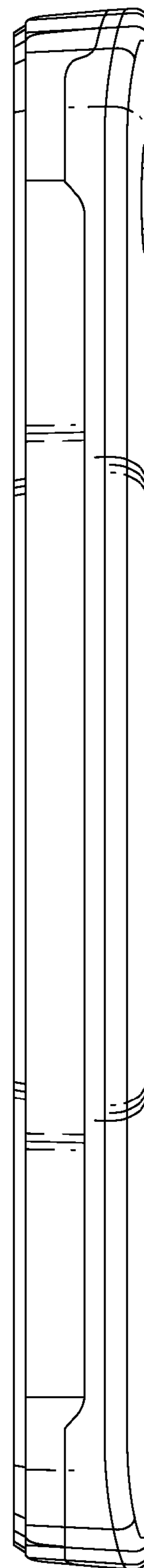

FIG. 6

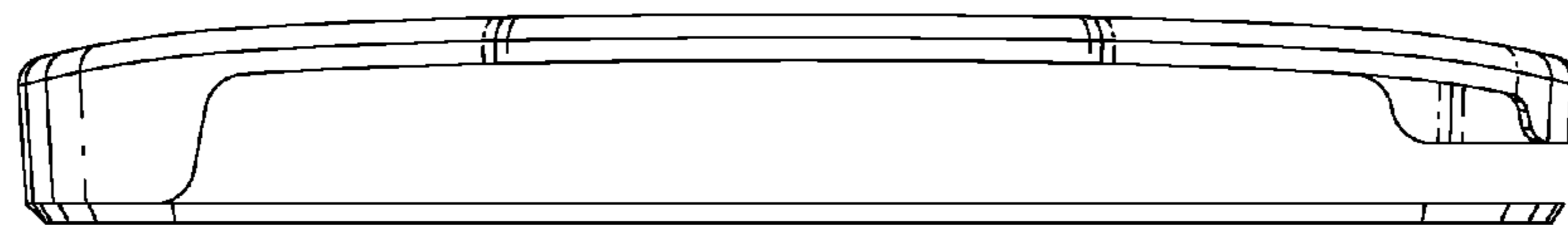

FIG. 7

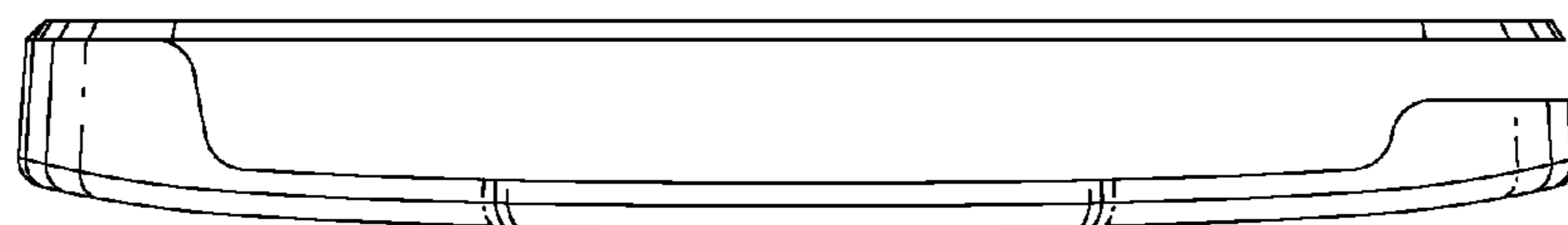

FIG. 8

