



US00D641335S

(12) **United States Design Patent**
Lee et al.

(10) **Patent No.:** **US D641,335 S**
(45) **Date of Patent:** **** Jul. 12, 2011**

(54) **MOBILE PHONE**

(75) Inventors: **Ji-Young Lee**, Seoul (KR); **Bum-Soo Park**, Gwangmyeong-si (KR); **Nam-Mi Kim**, Seoul (KR)

(73) Assignee: **Samsung Electronics Co., Ltd.**, Suwon-Si (KR)

(**) Term: **14 Years**

(21) Appl. No.: **29/379,767**

(22) Filed: **Nov. 24, 2010**

(30) **Foreign Application Priority Data**

Sep. 14, 2010 (KR) 30-2010-0040583

(51) **LOC (9) Cl.** **14-03**

(52) **U.S. Cl.** **D14/138 AA**

(58) **Field of Classification Search** D14/138 AA,
D14/496, 341, 345, 346, 203.3, 203.4, 203.7,
D14/138 AD, 138 R, 147, 218, 137; 455/575.1,
455/556.2, 575.3, 575.4; D21/517; 379/433.01,
379/433.04, 433.11, 433.12, 433.13; D13/168
See application file for complete search history.

(56) **References Cited**

U.S. PATENT DOCUMENTS

D543,182 S *	5/2007	Lee et al.	D14/138 AA
D543,186 S *	5/2007	Kim et al.	D14/138 AA
D556,171 S *	11/2007	Lee et al.	D14/138 AA
D563,931 S *	3/2008	Moon et al.	D14/138 AA
D566,093 S *	4/2008	Kim et al.	D14/138 AA
D573,573 S *	7/2008	Jung et al.	D14/138 AA
D576,585 S *	9/2008	Stillerman	D14/138 AA
D583,352 S *	12/2008	Son et al.	D14/138 AA
D590,367 S *	4/2009	Tompkin	D14/138 AA
D593,522 S *	6/2009	Chen	D14/138 AA
D597,056 S *	7/2009	Tkachuk	D14/138 AA
D608,320 S *	1/2010	Shi	D14/138 AA

D609,678 S *	2/2010	Ham	D14/138 AA
D610,109 S *	2/2010	Kim et al.	D14/138 AA
D610,111 S *	2/2010	Kim et al.	D14/138 AA
D610,565 S *	2/2010	Lee et al.	D14/138 AA
7,747,006 B2 *	6/2010	Kim et al.	379/434
D619,980 S *	7/2010	Kang	D14/138 AA
D620,466 S *	7/2010	Kim et al.	D14/138 AA
D620,911 S *	8/2010	Kim et al.	D14/138 AA
D628,178 S *	11/2010	Cai	D14/138 AA
D630,609 S *	1/2011	Yang	D14/138 AA
D634,289 S *	3/2011	Wang	D14/138 AA

OTHER PUBLICATIONS

Nokia 1661 telephone, announced Nov. 2008, [online], [site visited Mar. 25, 2011]. Available from Internet, <URL: <http://www.gsmarena.com>>.*

Samsung B130 telephone, announced Sep. 2008, [online], [site visited Mar. 25, 2011]. Available from Internet, <URL: <http://www.gsmarena.com>>.*

Samsung B110 telephone, announced Apr. 2008, [online], [site visited Mar. 25, 2011]. Available from Internet, <URL: <http://www.gsmarena.com>>.*

(Continued)

Primary Examiner — Jeff D Asch

(74) *Attorney, Agent, or Firm* — Staas & Halsey LLP

(57) **CLAIM**

The ornamental design for a mobile phone, as shown and described.

DESCRIPTION

FIG. 1 is a front perspective view of a mobile phone; FIG. 2 is a front view of the mobile phone of FIG. 1; FIG. 3 is a rear view of the mobile phone of FIG. 1; FIG. 4 is a left-side view of the mobile phone of FIG. 1; FIG. 5 is a right-side view of the mobile phone of FIG. 1; FIG. 6 is a top plan view of the mobile phone of FIG. 1; and, FIG. 7 is a bottom plan view of the mobile phone of FIG. 1.

1 Claim, 7 Drawing Sheets

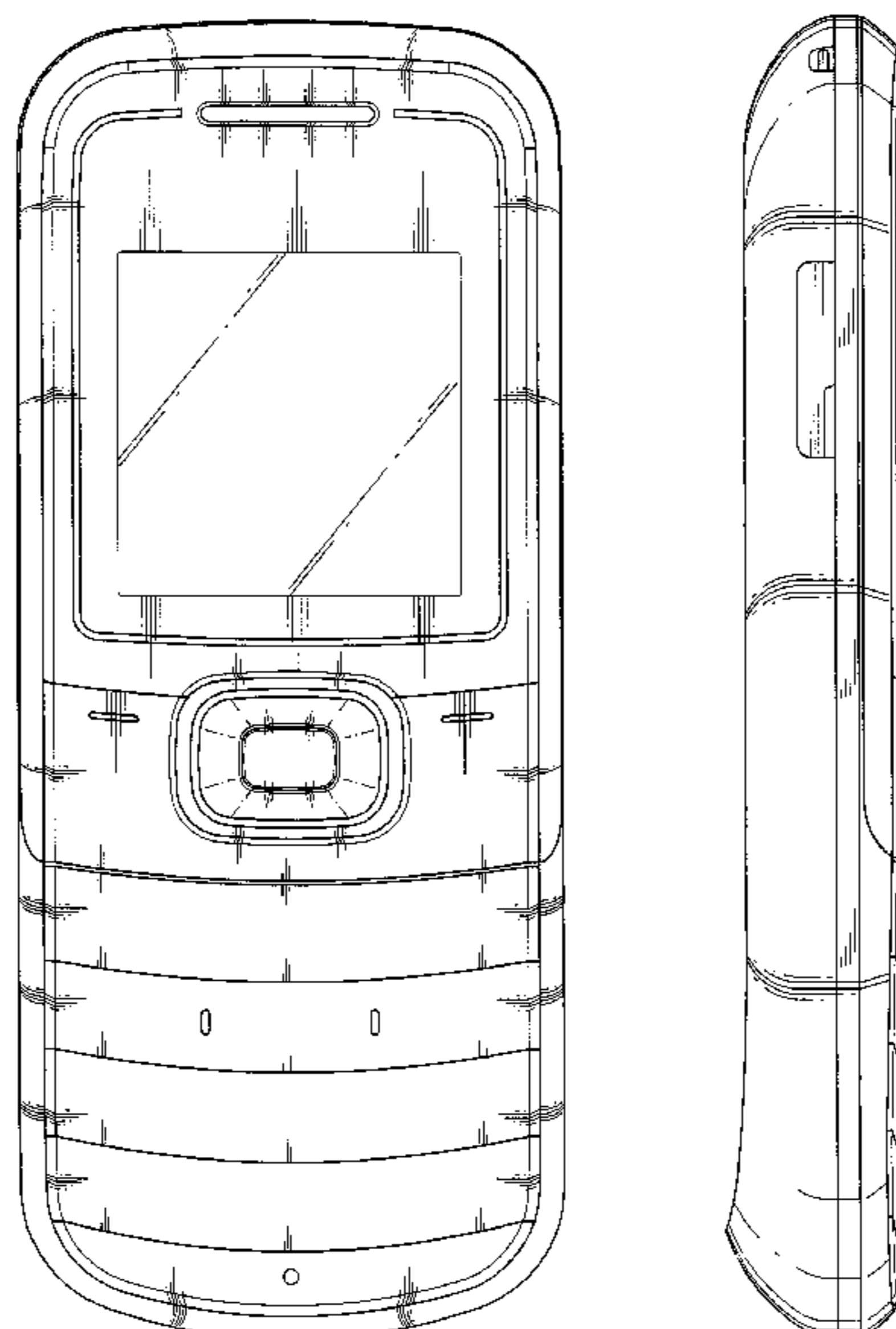

OTHER PUBLICATIONS

Samsung E1210 telephone, announced Apr. 2009, [online], [site visited Mar. 25, 2011]. Available from Internet, <URL: <http://www.gsmarena.com>>.*

Spice M-4242 telephone, announced 2010, [online], [site visited Mar. 25, 2011]. Available from Internet, <URL: <http://www.gsmarena.com>>.*

* cited by examiner

FIG. 1

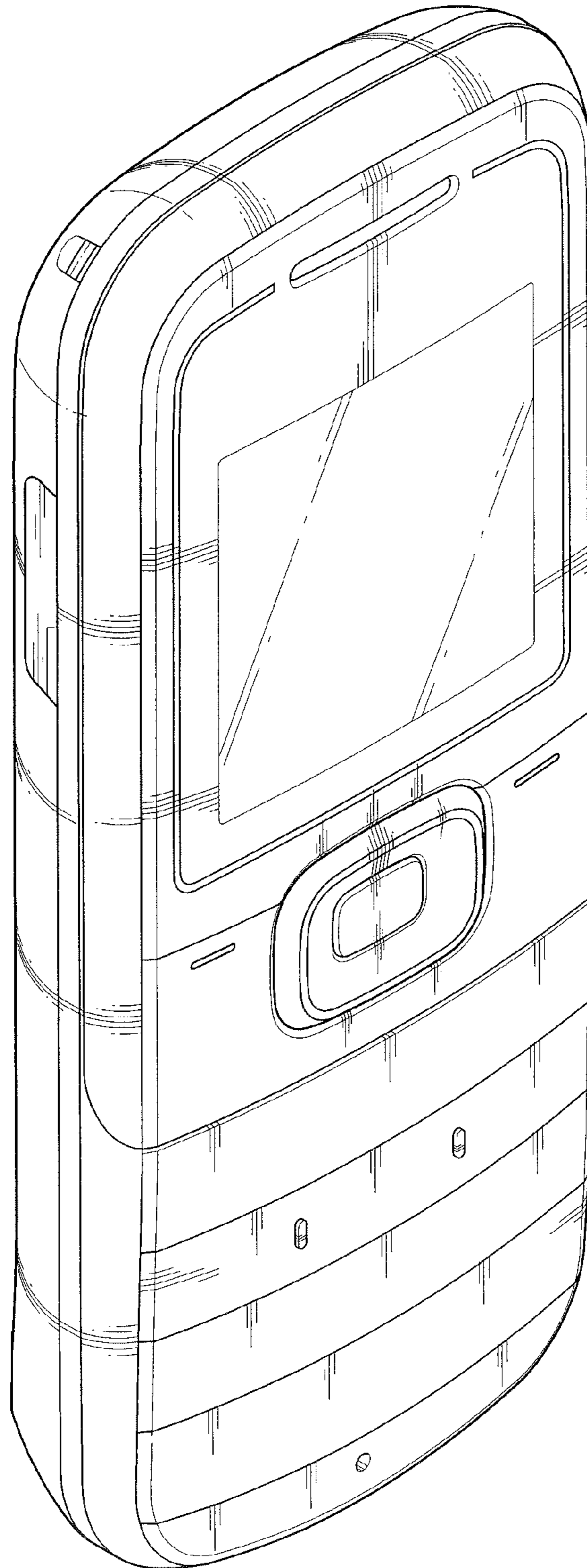

FIG. 2

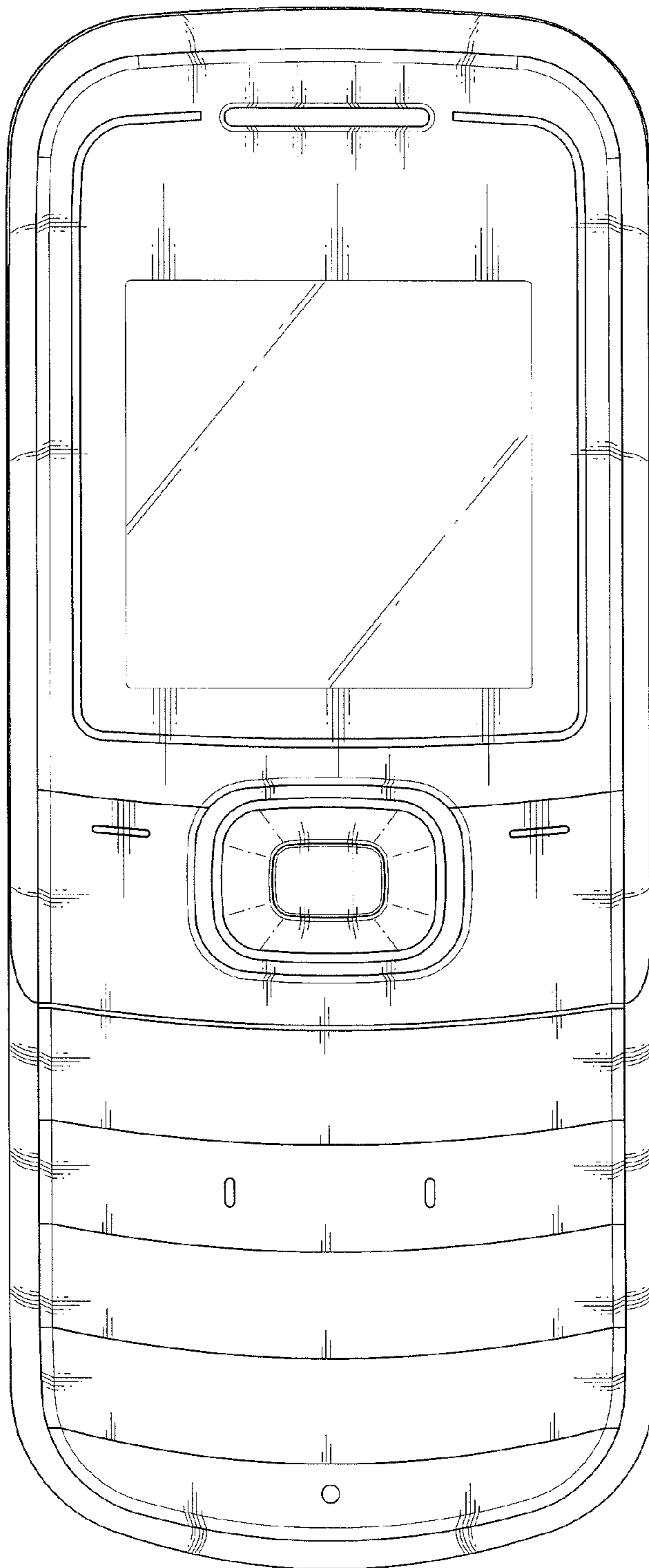

FIG. 3

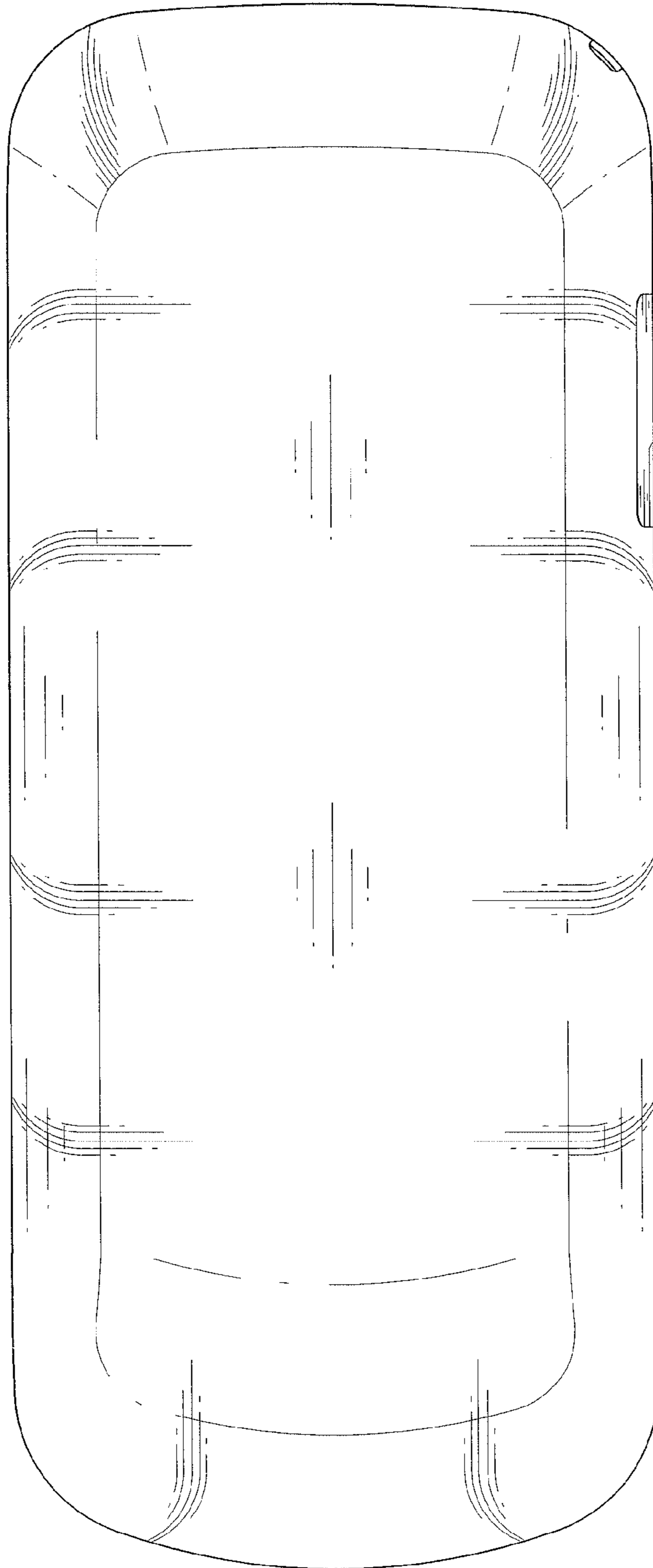

FIG. 4

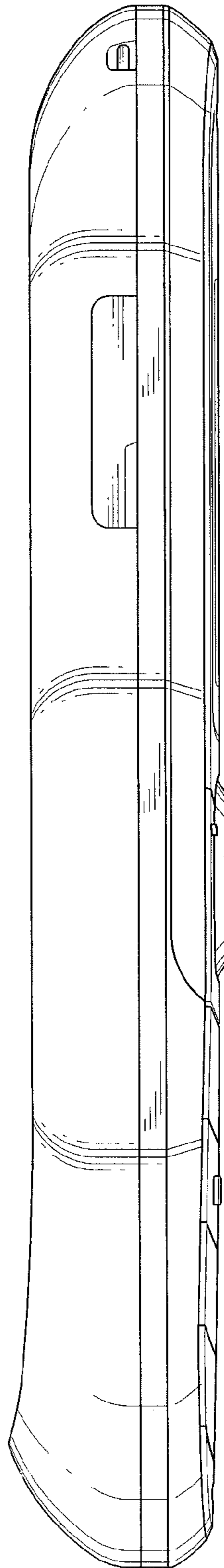

FIG. 5

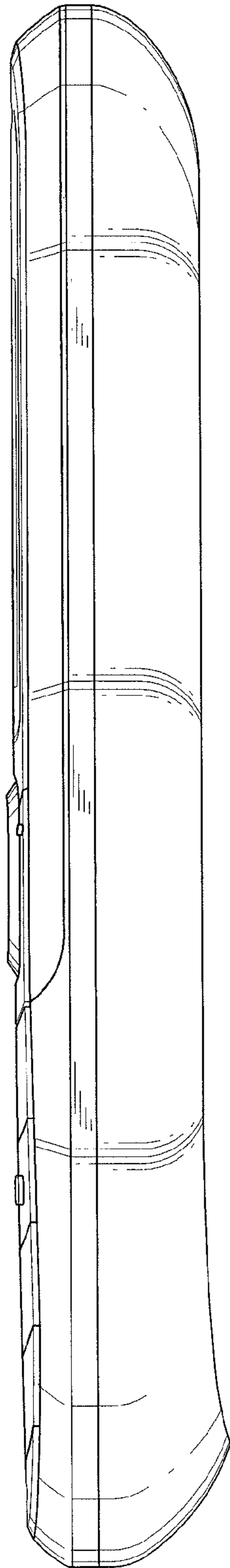

FIG. 6

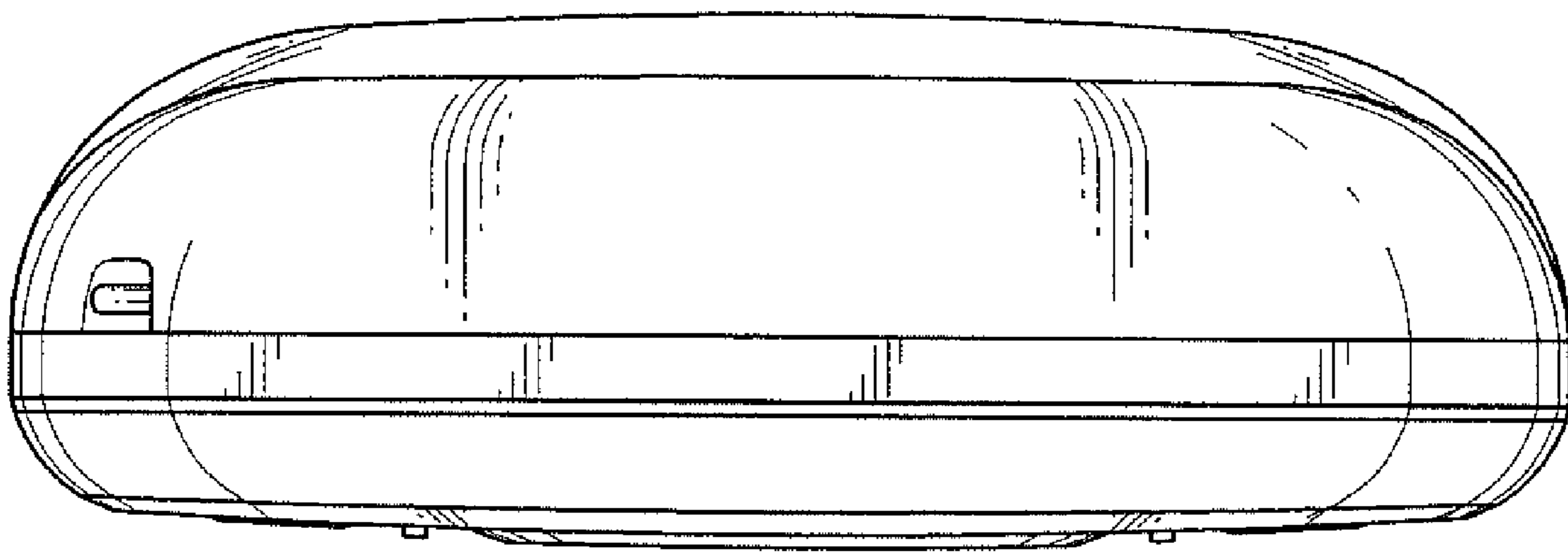

FIG. 7

