



US00D641326S

(12) **United States Design Patent**
Detemple et al.

(10) **Patent No.:** **US D641,326 S**
(45) **Date of Patent:** **** Jul. 12, 2011**

(54) **FUNCTION MODULE FOR LOW VOLTAGE SWITCHING DEVICES**

(75) Inventors: **Thomas Detemple**, Planegg (DE); **Peter Trautwein**, Munich (DE)

(73) Assignee: **Siemens Aktiengesellschaft**, Munich (DE)

(**) Term: **14 Years**

(21) Appl. No.: **29/358,862**

(22) Filed: **Apr. 1, 2010**

(30) **Foreign Application Priority Data**

Oct. 2, 2009 (EM) 001168561

(51) **LOC (9) Cl.** **13-03**

(52) **U.S. Cl.** **D13/159**

(58) **Field of Classification Search** D13/158, D13/159, 160, 162, 184, 199; 200/43.14, 200/50.01, 50.21-50.23; 361/42, 44, 50, 361/71, 115, 608, 634

See application file for complete search history.

(56) **References Cited**

U.S. PATENT DOCUMENTS

D274,720 S * 7/1984 Hannich et al. D13/159
D406,105 S * 2/1999 Gonser D13/159
D406,564 S * 3/1999 Gonser D13/159
D479,204 S * 9/2003 Nurdogan D13/159

* cited by examiner

Primary Examiner — Thomas J Johannes

(74) *Attorney, Agent, or Firm* — Harness, Dickey & Pierce, P.L.C.

(57) **CLAIM**

The ornamental design for a function module for low voltage switching devices, as shown and described.

DESCRIPTION

FIG. 1 is a front elevation view of a function module for low voltage switching devices showing our new design; FIG. 2 is a rear elevation view thereof; FIG. 3 is a top plan view thereof; FIG. 4 is a bottom plan view thereof; FIG. 5 is a left side elevation view thereof; FIG. 6 is a right side elevation view thereof; and, FIG. 7 is a perspective view thereof.

The broken line portion of the figure drawings is included to show unclaimed subject matter only and forms no part of the claimed design.

1 Claim, 7 Drawing Sheets

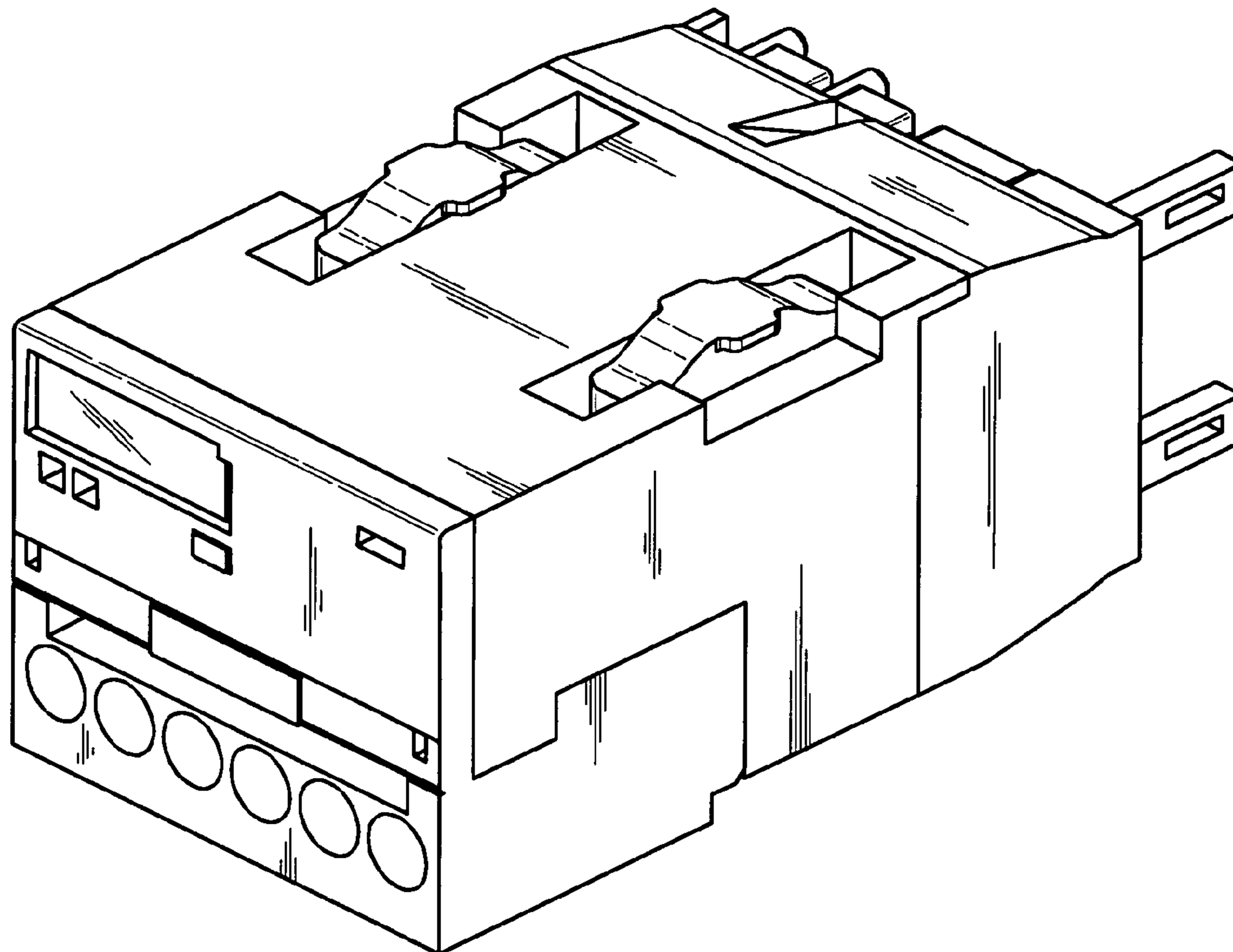

FIG 1

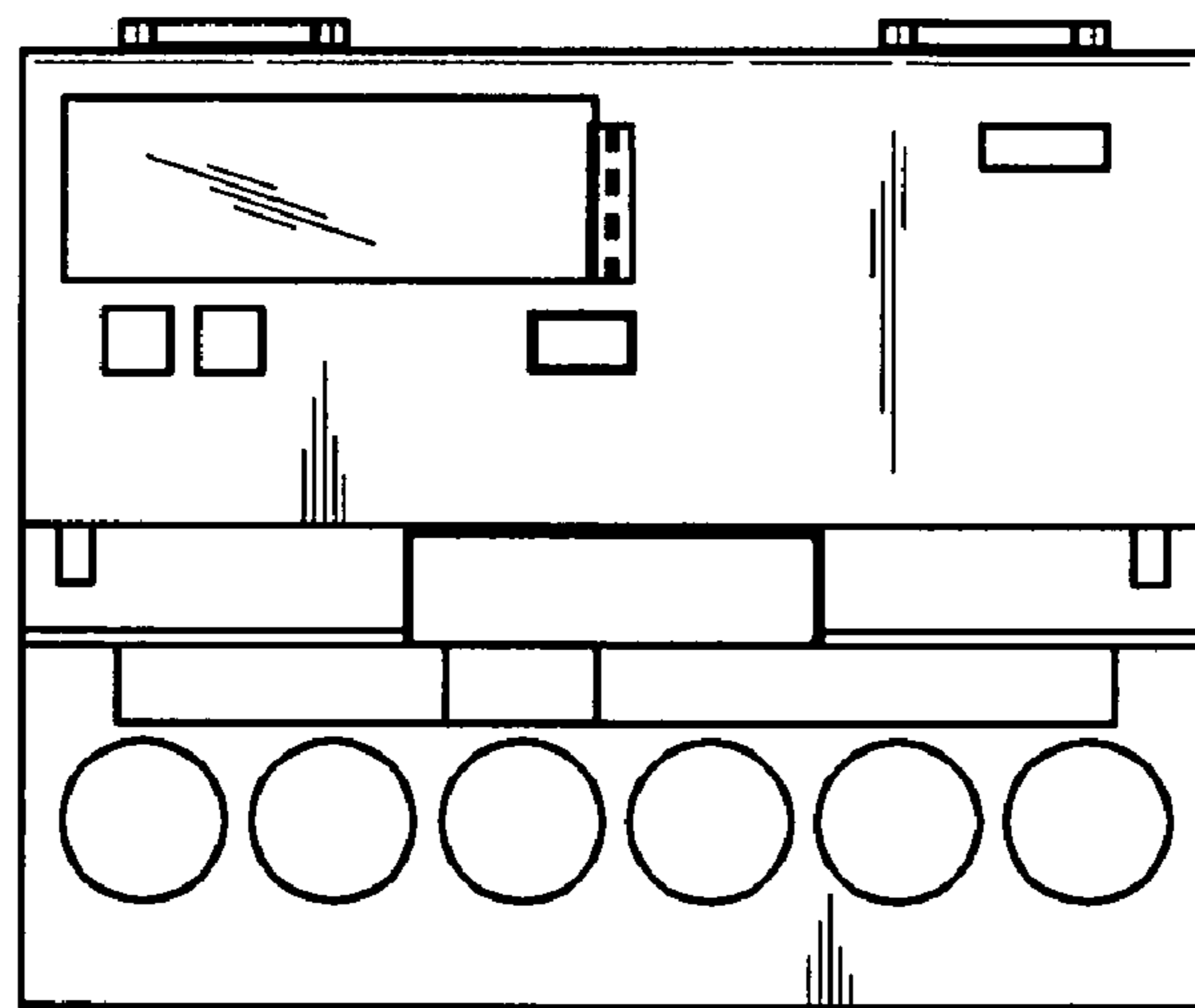

FIG 2

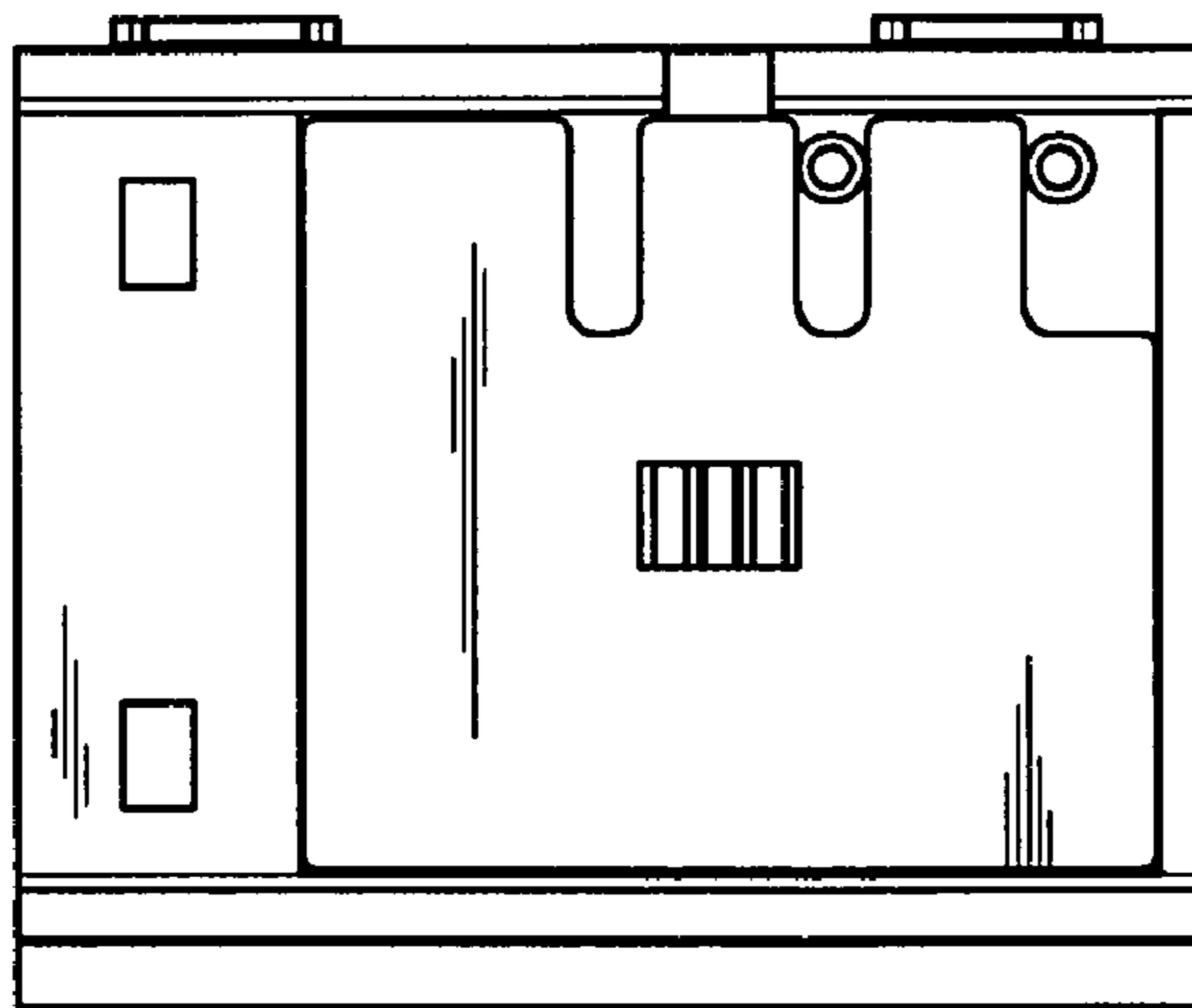

FIG 3

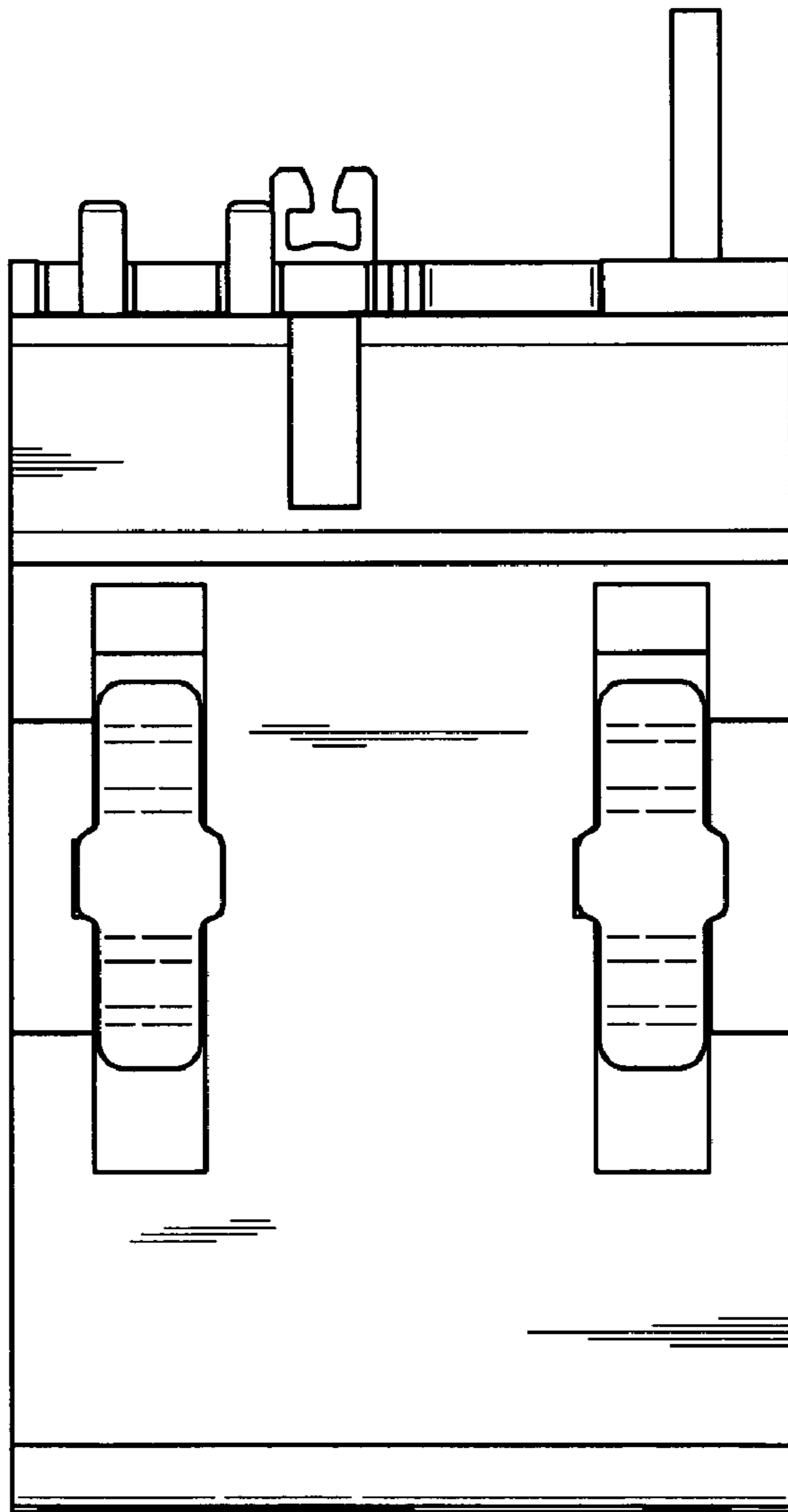

FIG 4

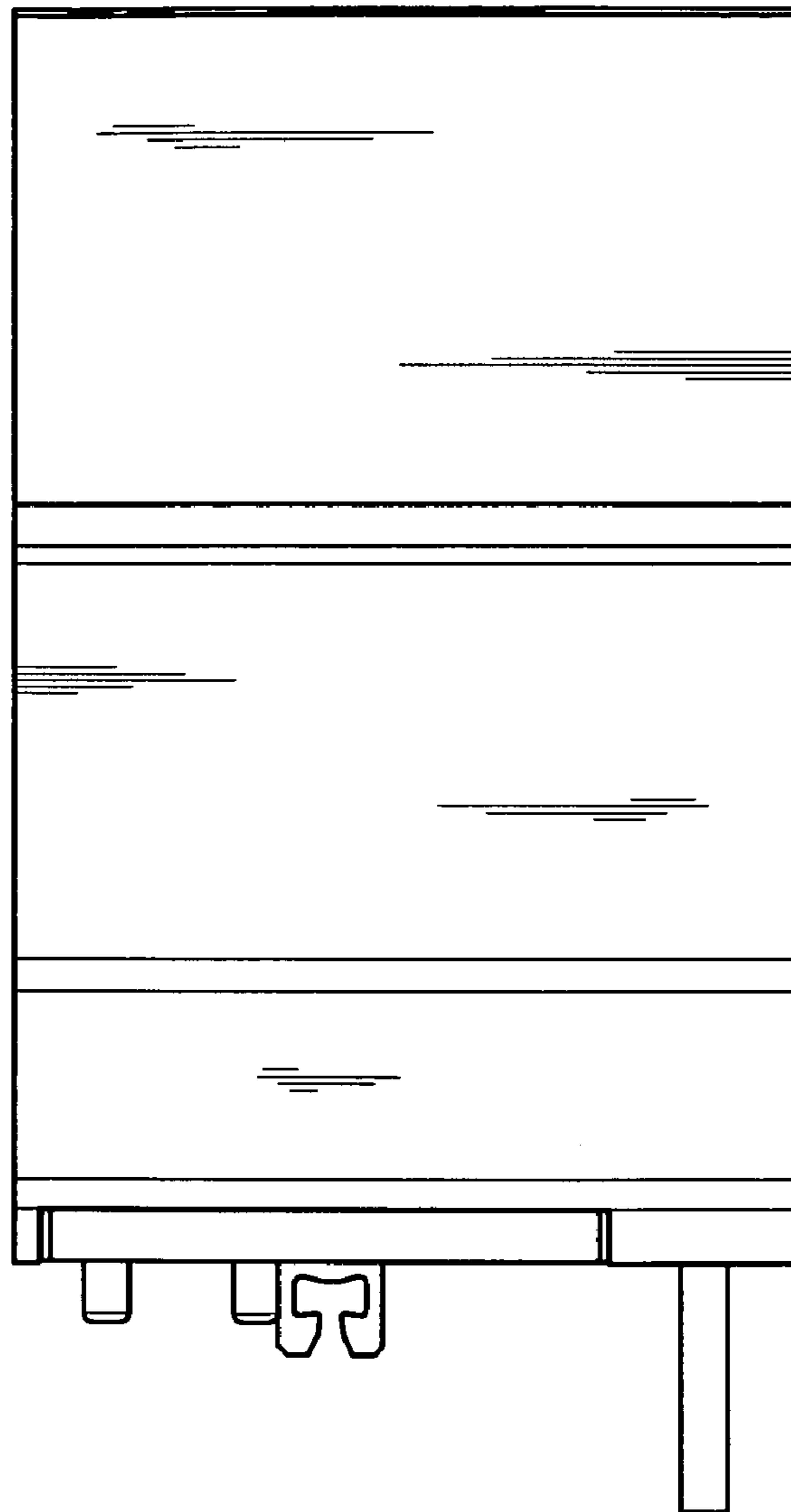

FIG 5

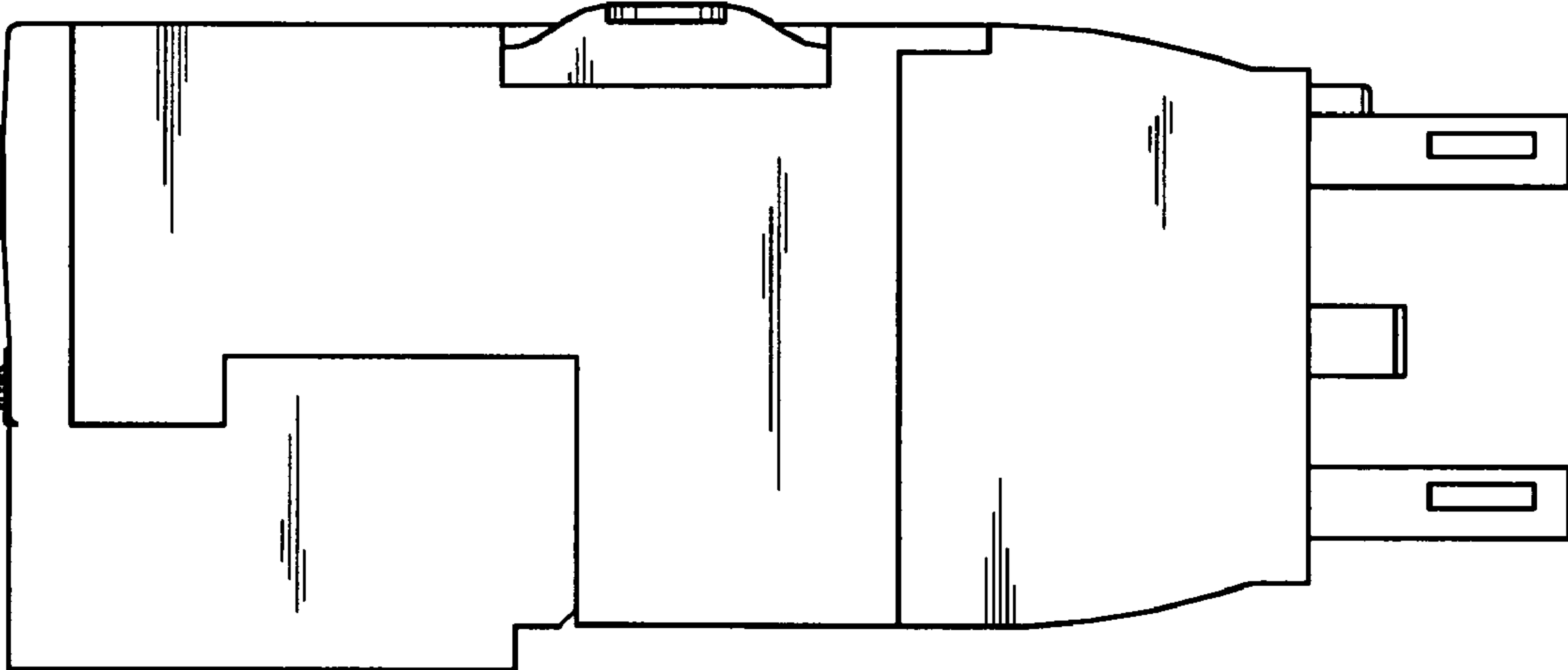

FIG 6

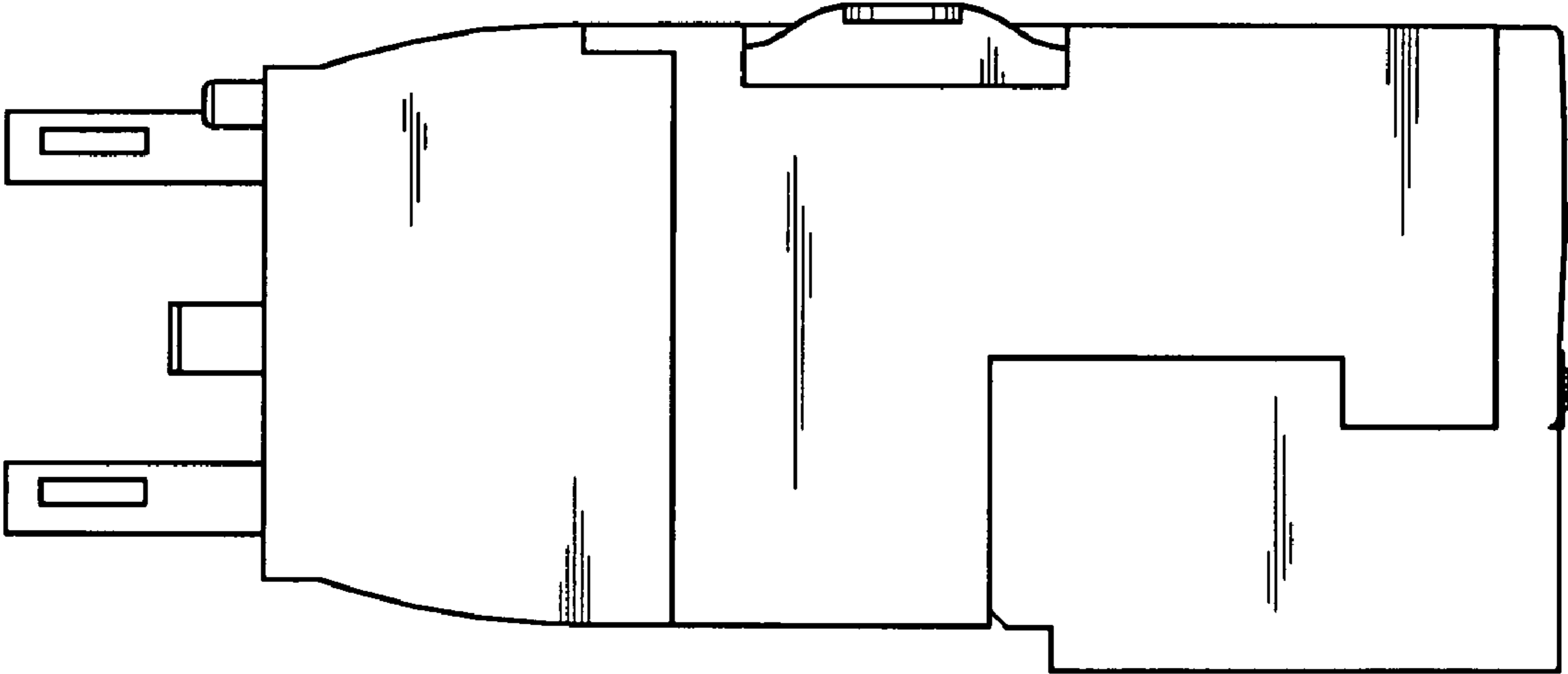

FIG 7

