

US00D641166S

(12) **United States Design Patent**
Zivanovic

(10) **Patent No.:** **US D641,166 S**
(45) **Date of Patent:** **** Jul. 12, 2011**

- (54) **HANDLE ASSEMBLY FOR A GUN CASE**
- (75) Inventor: **Slobodan Zivanovic**, Niles, IL (US)
- (73) Assignee: **Travel Caddy, Inc.**, Elk Grove Village, IL (US)
- (**) Term: **14 Years**
- (21) Appl. No.: **29/367,494**
- (22) Filed: **Aug. 9, 2010**
- (51) **LOC (9) Cl.** **03-01**
- (52) **U.S. Cl.** **D3/318; D3/262**
- (58) **Field of Classification Search** D3/262,
D3/318, 254; 206/315.1, 314, 317
See application file for complete search history.

(56) **References Cited**

U.S. PATENT DOCUMENTS

D358,255	S	5/1995	Sharp et al.	
5,893,502	A	4/1999	Redzisz	
D413,020	S	8/1999	Kolpin	
D448,163	S	9/2001	Kolpin	
D448,558	S	10/2001	Kolpin	
D448,559	S	10/2001	Kolpin	
D448,560	S	10/2001	Kolpin	
D448,561	S	10/2001	Kolpin	
D448,562	S	10/2001	Kolpin	
6,431,355	B1 *	8/2002	Miura et al.	206/315.8
D486,960	S *	2/2004	Sauey et al.	D3/262
D488,927	S *	4/2004	Cook et al.	D3/254
D570,602	S *	6/2008	Lyons et al.	D3/318
D591,049	S *	4/2009	Gonzalez	D3/318
2004/0173655	A1	9/2004	Markson	

OTHER PUBLICATIONS

Redhead Rifle or Shotgun Case—Bass Pro Shops [online], retrieved on Nov. 16, 2010 Retrieved From the On Line Catalog using internet <URL: <http://www.basspro.com/RedHead®-Rifle-or-Shotgun-Case/product/65528/-1161395>.

BlackHawk! Scoped Rifle Case—Blackhawk [online], Retrieved From the On Line Catalog using internet <URL: <http://www.blackhawk.com/product/Scoped-Rifle-Case,141,134.htm>; Prior Art.

RedHead 1865 Collection Rifle Scope Case—Bass Pro Shops [online], Retrieved From the On Line Catalog using internet <URL: <http://www.basspro.com/RedHead-1885-Collection-Rifle-Scope-Case/product/10216480/-1687337>; Prior Art.

RedHead Scoped Rifle Case—with Rubber End Cups—Bass Pro [online], Retrieved From the On Line Catalog using internet <URL: <http://www.basspro.com/RedHead-Scoped-Rifle-Case-with-Rubber-End-Cups/product/65527/-1161393>; Prior Art.

RedHead Rifle or Shotgun Case—PVC Armor—Bass Pro Shops [online], Retrieved From the On Line Catalog using internet <URL: <http://www.basspro.com/RedHead®-Rifle-or-Shotgun-Case/product/85528/-1161357>; Prior Art.

BenelliUSA GearStore-Benelli Scoped Gun Case—Benelli Gear Store [online], Retrieved From the On Line Catalog using internet <URL: <http://www.benelliusa.com/store/Bags-and-Cases/Benelli-Scoped-Gun-Case-p61.html>; Prior Art.

(Continued)

Primary Examiner — Holly Baynham

(74) *Attorney, Agent, or Firm* — Fitch Even Tabin & Flannery

(57) **CLAIM**

I claim the ornamental design for a handle assembly for a gun case, as shown and described.

DESCRIPTION

FIG. 1 is a perspective view of a handle assembly for a gun case, showing my/our new design;

FIG. 2 is a right side elevational view thereof;

FIG. 3 is a left side elevational view thereof;

FIG. 4 is a top plan view thereof;

FIG. 5 is a bottom plan view thereof;

FIG. 6 is a rear elevational view thereof; and,

FIG. 7 is a front elevational view thereof.

The broken line showing of a gun case is included for the purpose of illustrating environment and forms no part of the claimed design.

1 Claim, 6 Drawing Sheets

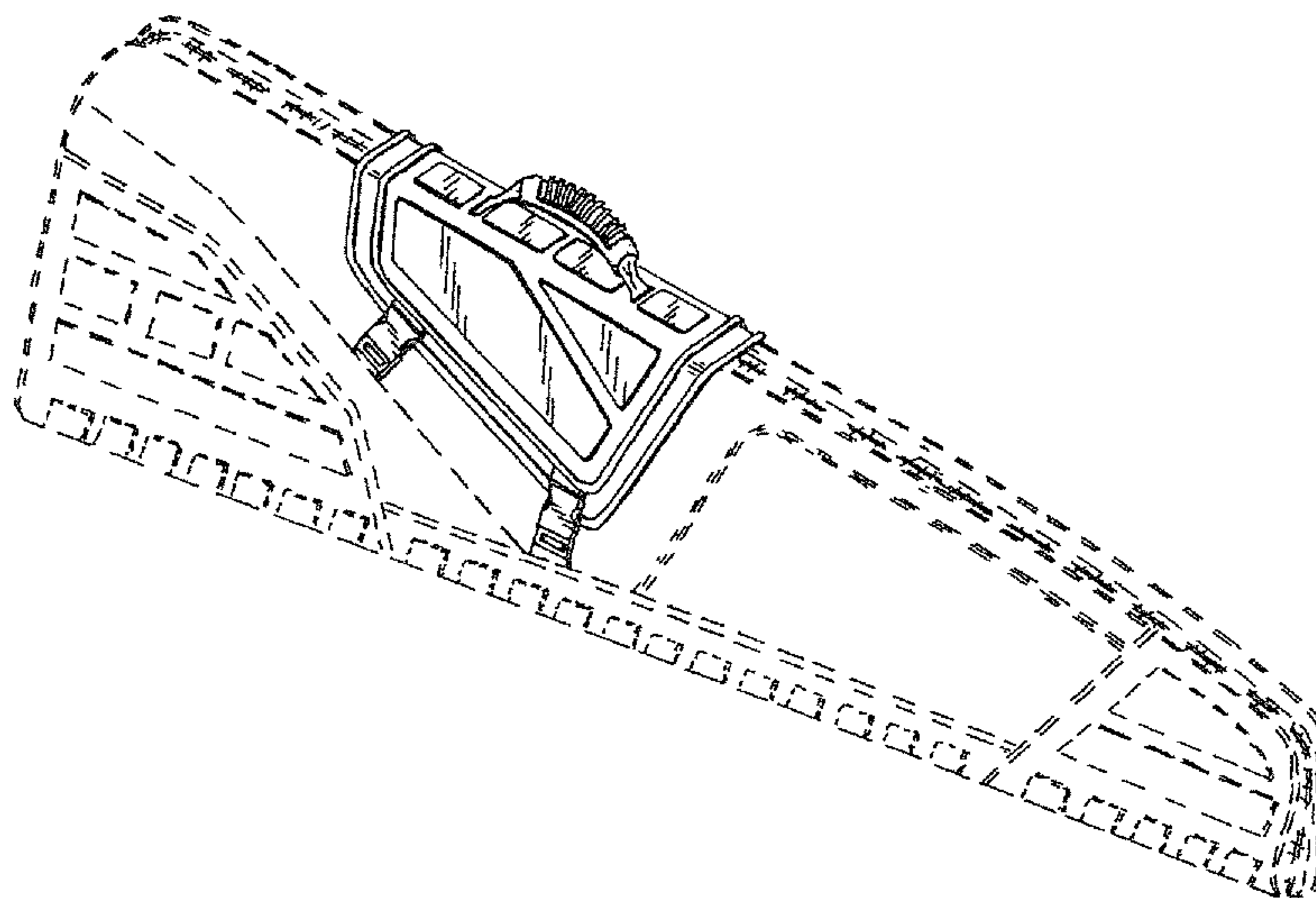

OTHER PUBLICATIONS

Boundary Lakes Shotgun Case GC36—Boyt Harness Company, LLC [online], Retrieved From the On Line Catalog using internet <URL: http://www.boytharness.com/catalog/product_info.php?cPath=31_40&products_id=134; Prior Art.

Plano Molding—[online], retrieved on Nov. 16, 2010 Retrieved From the On Line Catalog using internet <URL: <http://www.planomolding.com/hunting/hunting-products/>; Prior Art.

* cited by examiner

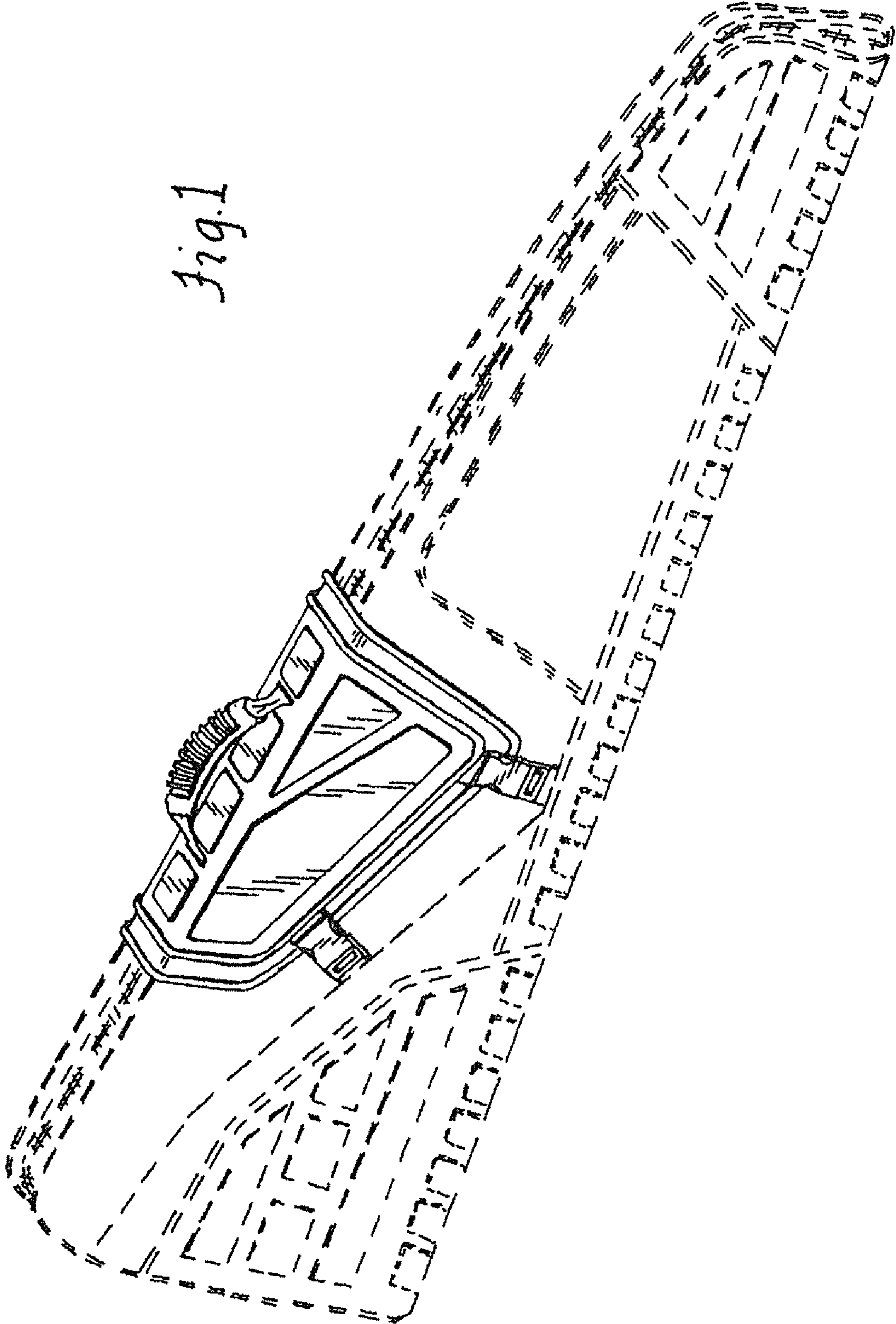

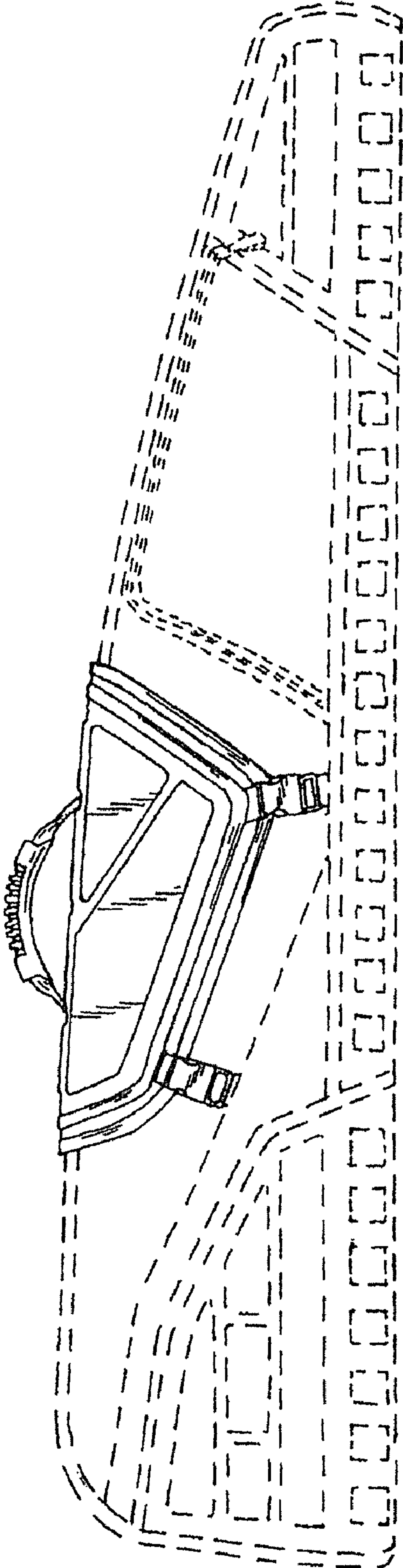

Fig. 2

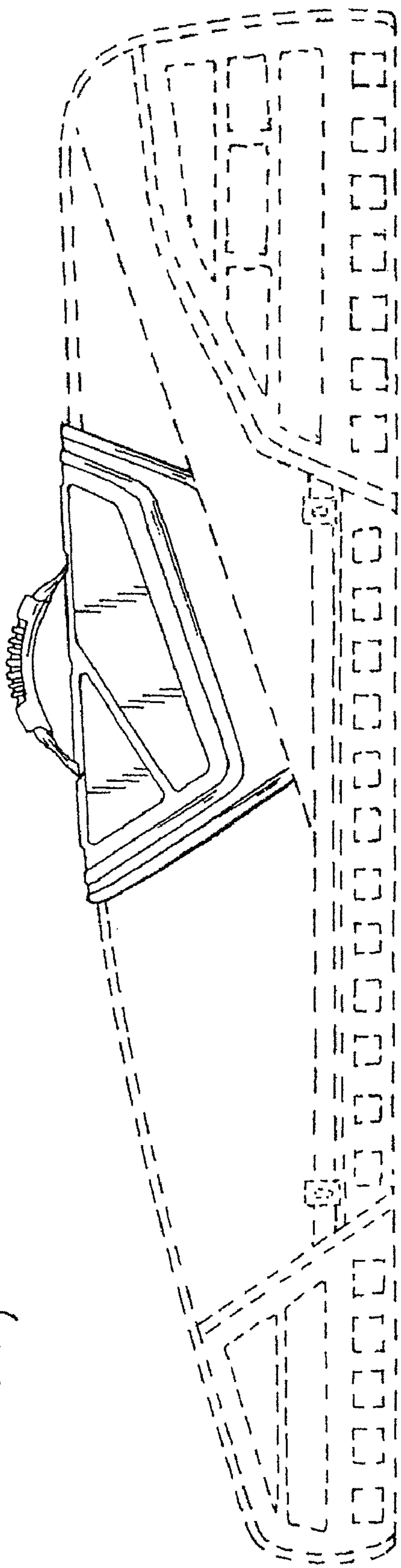

Fig. 3

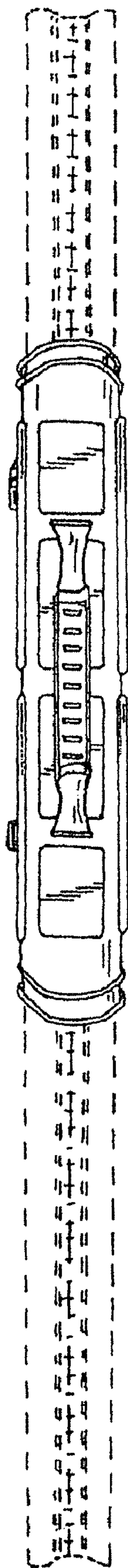

Fig. 4

Fig. 5

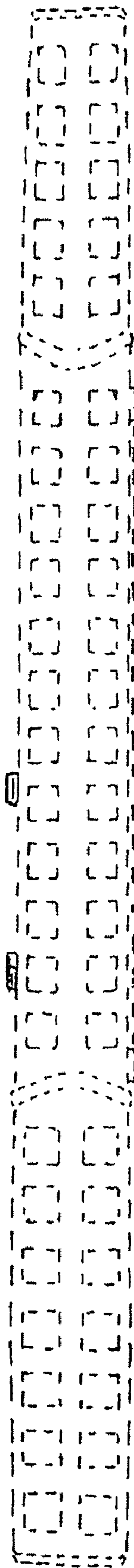

Fig. 6

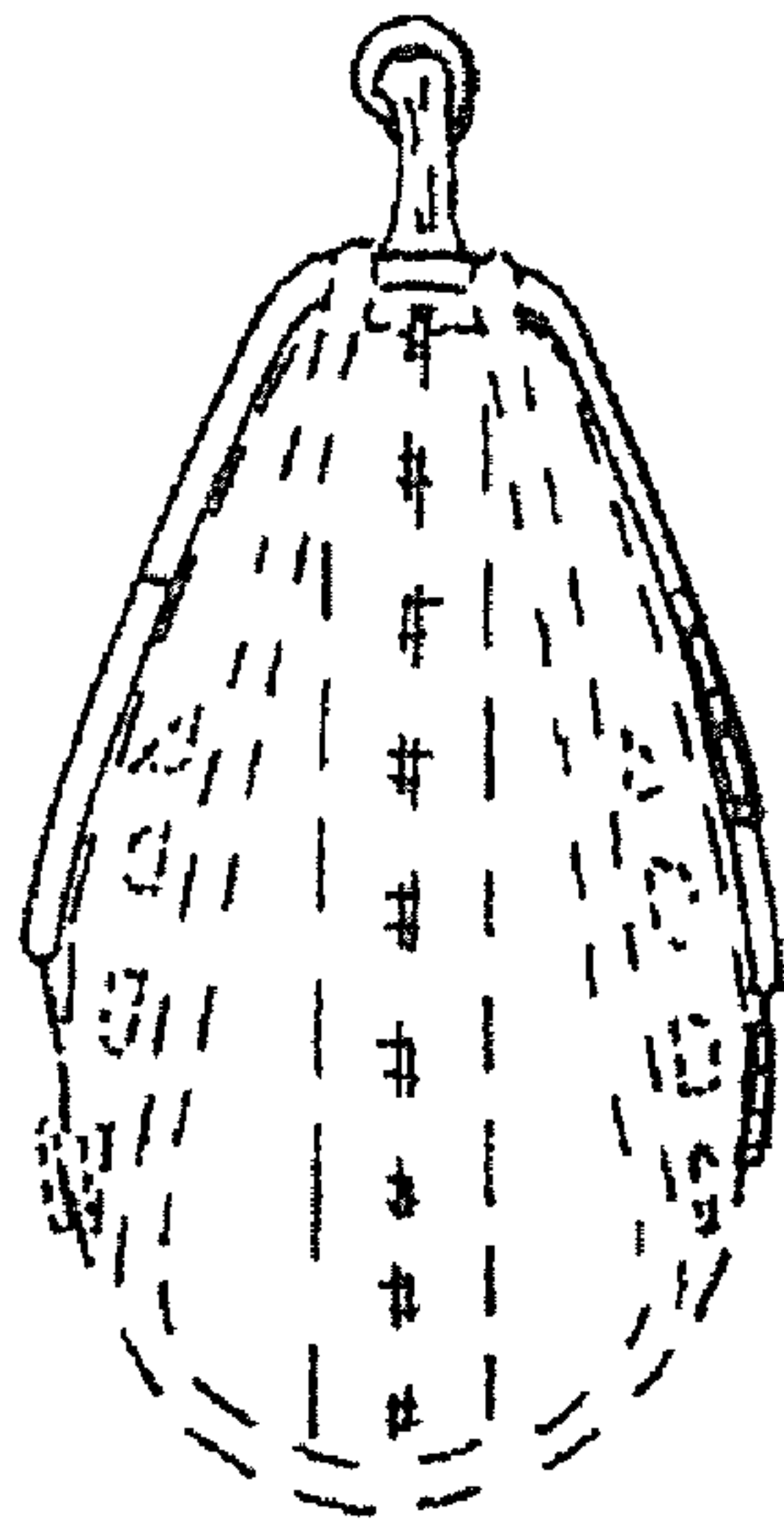

Fig. 7

