



US00D641161S

(12) **United States Design Patent**
Houston et al.

(10) **Patent No.:** **US D641,161 S**
(45) **Date of Patent:** **** Jul. 12, 2011**

(54) **CABLE PAYOUT CADDY**

(75) Inventors: **Eddy Robert Houston**, Claremont, NC (US); **David Lewis Wilson**, Stony Point, NC (US)

(73) Assignee: **CommScope, Inc. of North Carolina**, Hickory, NC (US)

(**) Term: **14 Years**

(21) Appl. No.: **29/381,738**

(22) Filed: **Dec. 22, 2010**

Related U.S. Application Data

(63) Continuation of application No. 29/338,572, filed on Jun. 15, 2009.

(51) **LOC (9) Cl.** **03-01**

(52) **U.S. Cl.** **D3/276**

(58) **Field of Classification Search** 242/129,
242/588-588.3, 370; 206/409, 397, 398;
D3/273, 274, 276, 283-291, 299, 301; D8/358
See application file for complete search history.

(56) **References Cited**

U.S. PATENT DOCUMENTS

D196,953	S	11/1963	Jepson et al.	
3,150,769	A *	9/1964	Cohn	242/588.2
3,412,847	A *	11/1968	Wise et al.	242/588.1
D248,891	S	8/1978	Pfleger	
D284,333	S *	6/1986	Huston	D3/283
4,650,073	A *	3/1987	Young	206/409
4,771,889	A *	9/1988	Bauer et al.	242/588.3
5,139,210	A *	8/1992	Schaffer	242/129
D333,039	S	2/1993	Wells et al.	
D340,387	S *	10/1993	Melk	D3/289

D340,621	S *	10/1993	Melk	D3/287
D340,840	S *	11/1993	Melk	D3/283
D414,082	S	9/1999	Keene	
6,145,780	A	11/2000	Fontana	
6,216,978	B1	4/2001	Rodriguez	
6,966,791	B1	11/2005	Farr	
D529,286	S	10/2006	Limber	
7,792,316	B2	9/2010	Tan et al.	
2007/0215502	A1 *	9/2007	Babcock et al.	206/409
2009/0260922	A1	10/2009	Marquardt et al.	
2010/0006692	A1 *	1/2010	Galgano et al.	242/588.4
2010/0314484	A1 *	12/2010	Houston et al.	242/588.3
2010/0320310	A1 *	12/2010	McManus et al.	242/588.3

* cited by examiner

Primary Examiner — Jennifer Rivard

(74) *Attorney, Agent, or Firm* — Myers Bigel Sibley & Sajovec

(57) **CLAIM**

The ornamental design for a cable payout caddy, as shown and described.

DESCRIPTION

FIG. 1 is a front perspective view illustrating our cable payout caddy design;

FIG. 2 is a front view thereof;

FIG. 3 is a side view thereof;

FIG. 4 is an opposing side view thereof;

FIG. 5 is a rear view thereof;

FIG. 6 is a top view thereof;

FIG. 7 is a bottom view thereof; and,

FIG. 8 is a top perspective view of our cable payout caddy design shown in an open configuration.

The broken lines shown herein are for illustrative purposes only and form no part of the claimed design.

1 Claim, 7 Drawing Sheets





FIG. 1

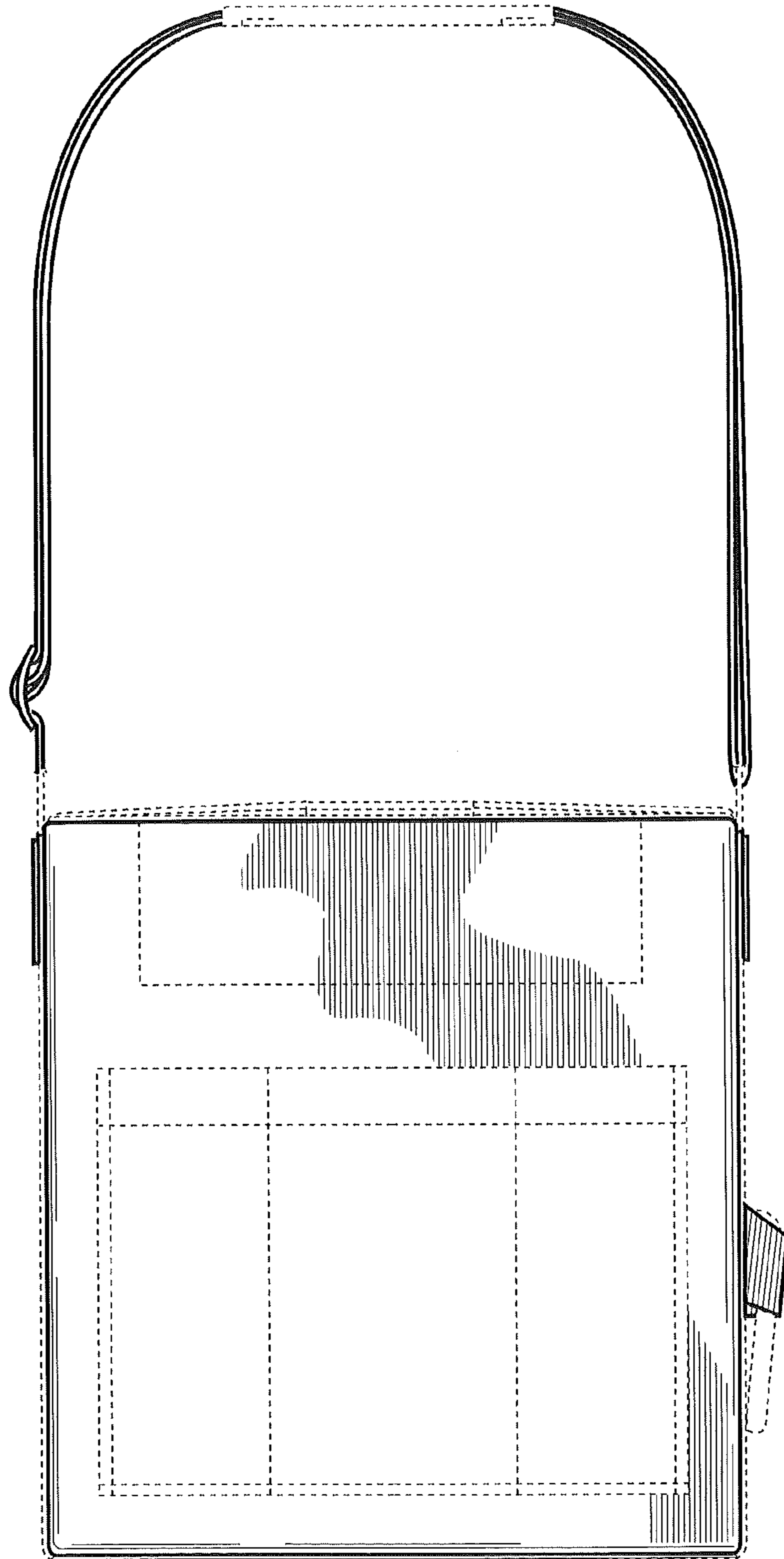

FIG. 2

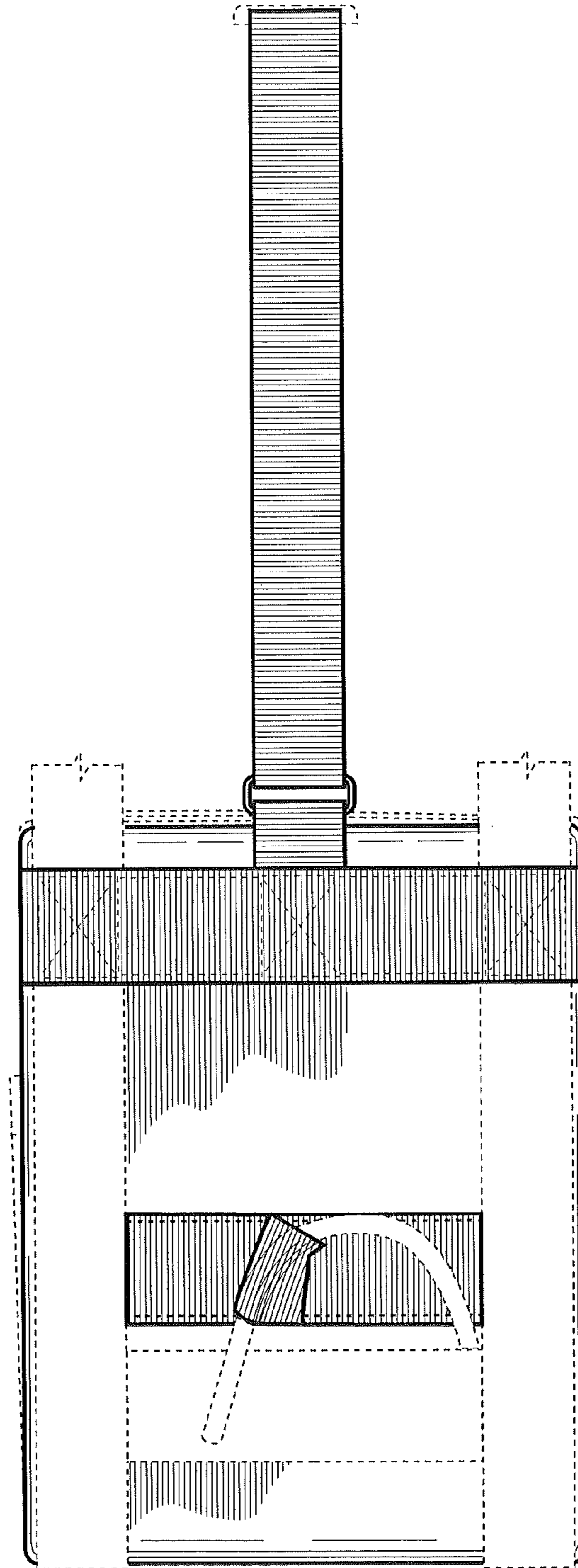

FIG. 3

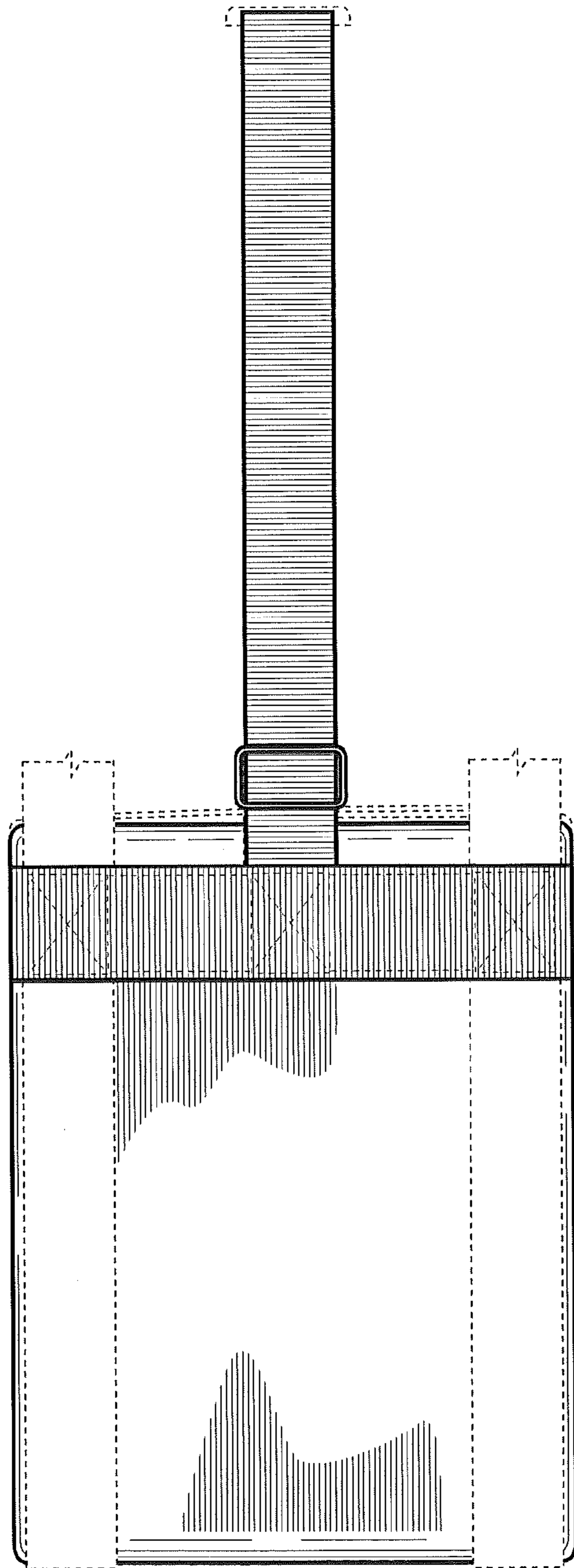

FIG. 4

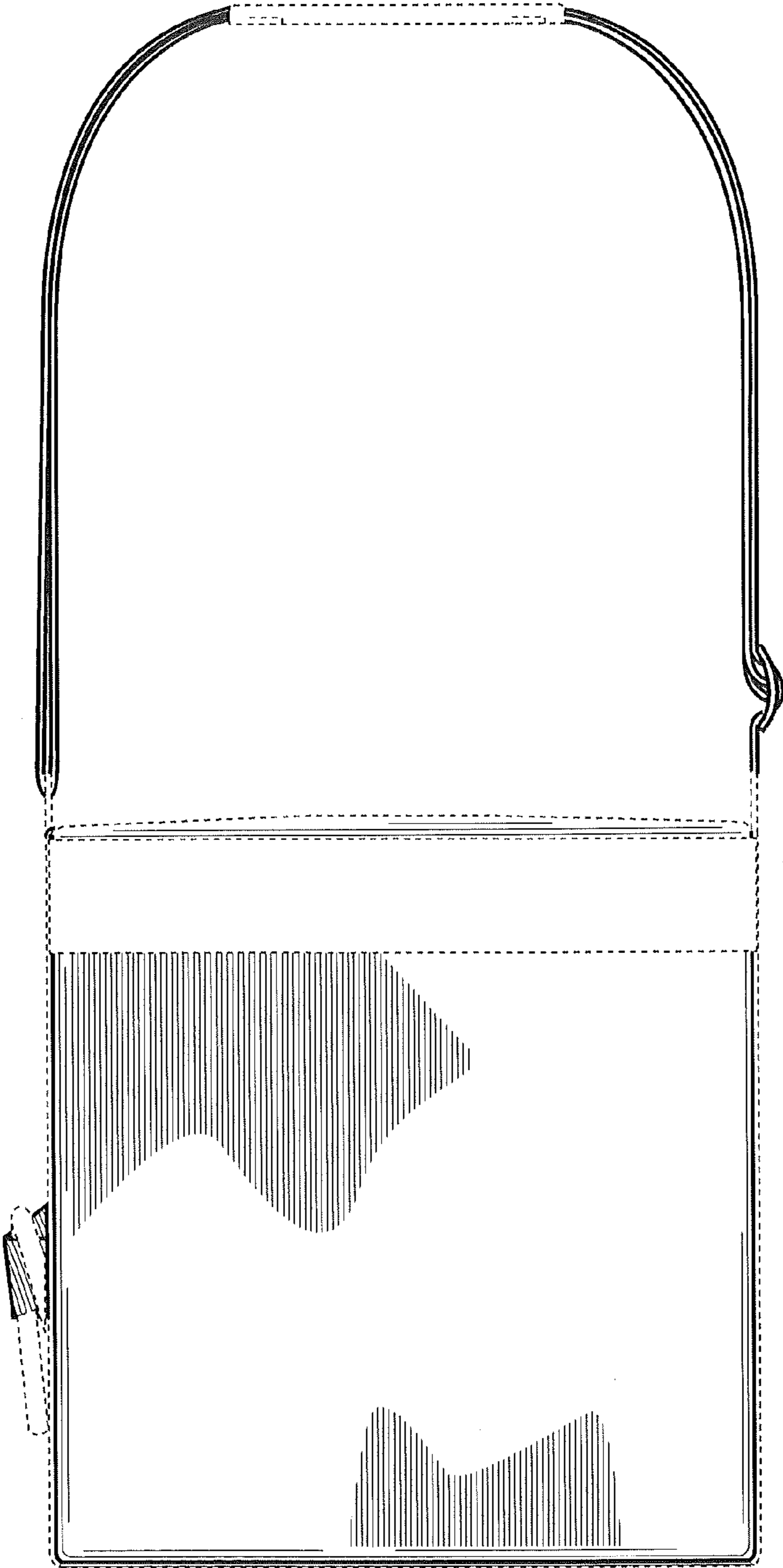

FIG. 5

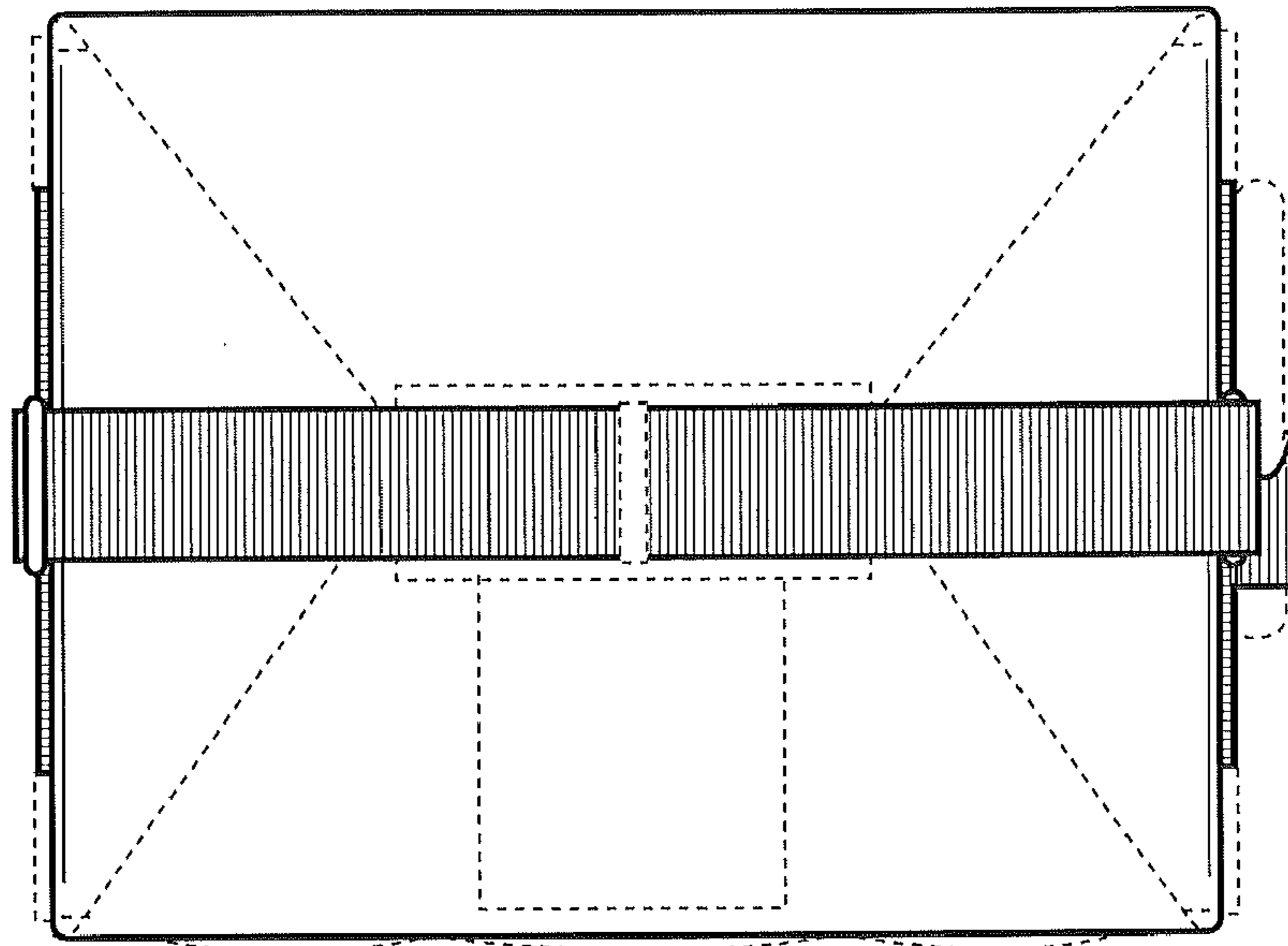

FIG. 6

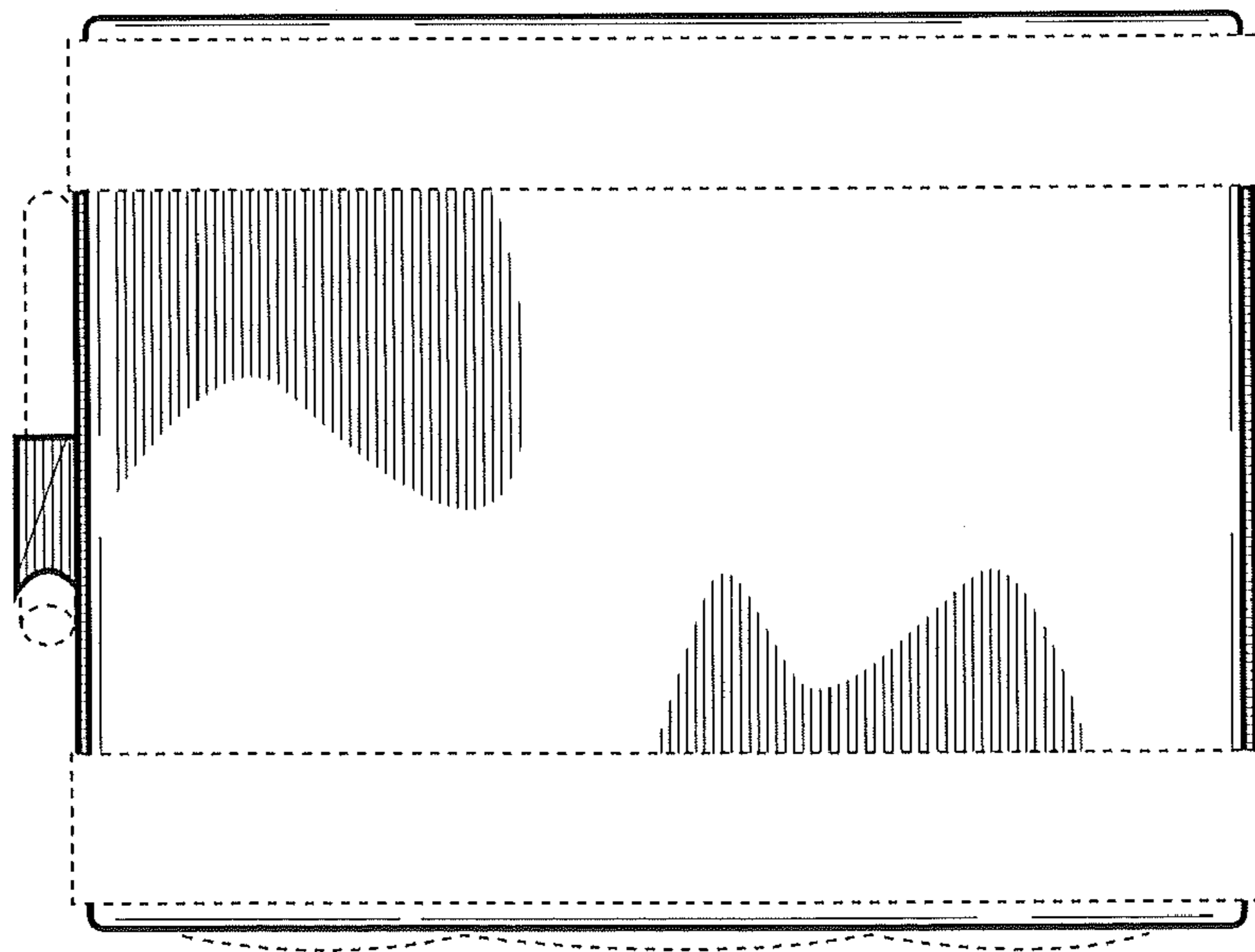

FIG. 7

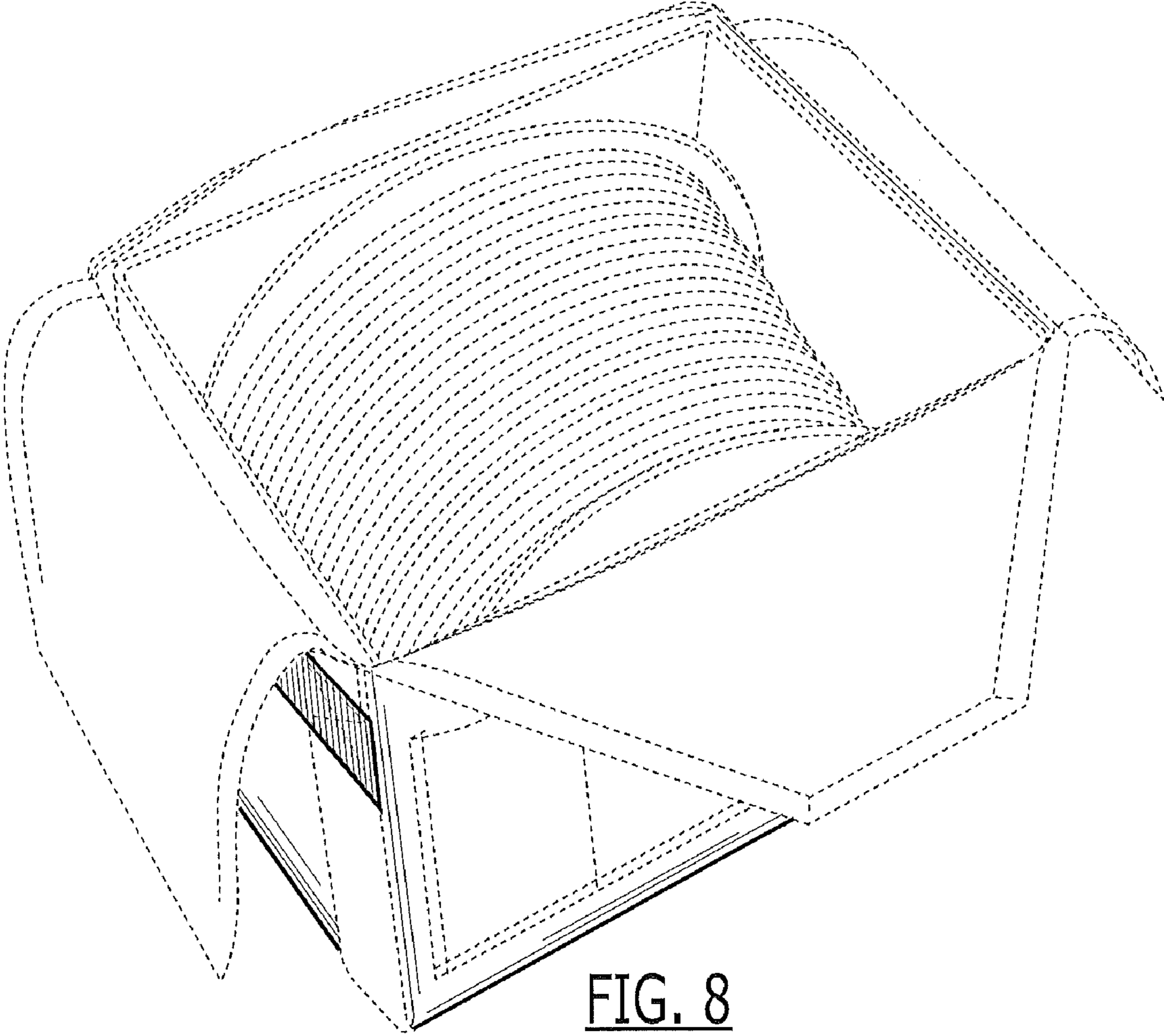

FIG. 8