



US00D641151S

(12) **United States Design Patent**  
**Bernatchez**

(10) **Patent No.:** **US D641,151 S**  
(45) **Date of Patent:** **\*\* Jul. 12, 2011**

(54) **L-SHAPED KEY HOLDER**  
(75) Inventor: **Georges-André Bernatchez,**  
St-Augustin-de-Desmaures (CA)  
(73) Assignee: **Yoogo Projections Inc.,**  
Saint-Augustin-de-Desmaures (CA)  
(\*\*) Term: **14 Years**  
(21) Appl. No.: **29/380,724**

6,811,493	B1	11/2004	Lee
D504,222	S	4/2005	Kieffer
D505,784	S	6/2005	Yeh
D509,353	S	9/2005	Billings
6,942,362	B1	9/2005	Deutsch
7,156,535	B1	1/2007	Deutsch
7,185,999	B2	3/2007	Lui
D580,160	S *	11/2008	Wilson et al. .... D3/207
2002/0017231	A1	2/2002	Tanaka
2004/0155781	A1	8/2004	DeOme
2005/0237736	A1	10/2005	Wimsatt
2007/0133201	A1	6/2007	Lui
2007/0238532	A1	10/2007	Stethem
2008/0178251	A1	7/2008	Shin

(22) Filed: **Dec. 10, 2010**  
(51) **LOC (9) Cl.** ..... **03-01**  
(52) **U.S. Cl.** ..... **D3/212**  
(58) **Field of Classification Search** ..... D3/207-212;  
D11/31-33, 44, 48-51, 66; 70/456 R, 456 B,  
70/457-460; 24/3.6; D13/168; 362/116;  
D8/348

**FOREIGN PATENT DOCUMENTS**

CA	2052972	5/1992
WO	9111054	7/1991
WO	2008045003	4/2008
WO	2010146571	12/2010

\* cited by examiner

See application file for complete search history.

*Primary Examiner* — R. Seifert

(74) *Attorney, Agent, or Firm* — King & Spalding LLP

(56) **References Cited**

**U.S. PATENT DOCUMENTS**

4,160,369	A	7/1979	Pearson	
D252,541	S *	8/1979	Harper	..... D3/211
4,498,669	A	2/1985	Chun	
4,739,990	A	4/1988	Aguirre	
D301,513	S	6/1989	Wright	
D308,297	S	6/1990	Romano	
5,108,098	A	4/1992	Ashihara	
D333,692	S	3/1993	Parsons	
5,192,074	A	3/1993	Ashihara	
D352,339	S	11/1994	McGowan	
5,405,134	A	4/1995	Wolfram	
D360,720	S *	7/1995	Drevo et al.	..... D32/46
5,475,368	A	12/1995	Collins	
5,712,619	A	1/1998	Simkin	
5,783,875	A	7/1998	Jaros	
D398,365	S	9/1998	Bader	
5,829,643	A	11/1998	Isabella	
5,863,251	A	1/1999	Fusco	
D428,695	S *	8/2000	Rothschild	..... D3/211
6,147,611	A	11/2000	Otero	
D442,448	S *	5/2001	Kelleghan	..... D8/38

(57) **CLAIM**

The ornamental design for an L-shaped key holder, as shown and described.

**DESCRIPTION**

FIG. 1 is a left side perspective view of an L-shaped key holder showing my new design;  
FIG. 2 is a right side perspective view;  
FIG. 3 is a top view;  
FIG. 4 is a bottom view;  
FIG. 5 is a front view;  
FIG. 6 is a back view;  
FIG. 7 is a left side view; and,  
FIG. 8 is a right side view.  
The broken line showing is included for the purpose of illustrating environmental matter and forms no part of the claimed design.

**1 Claim, 4 Drawing Sheets**

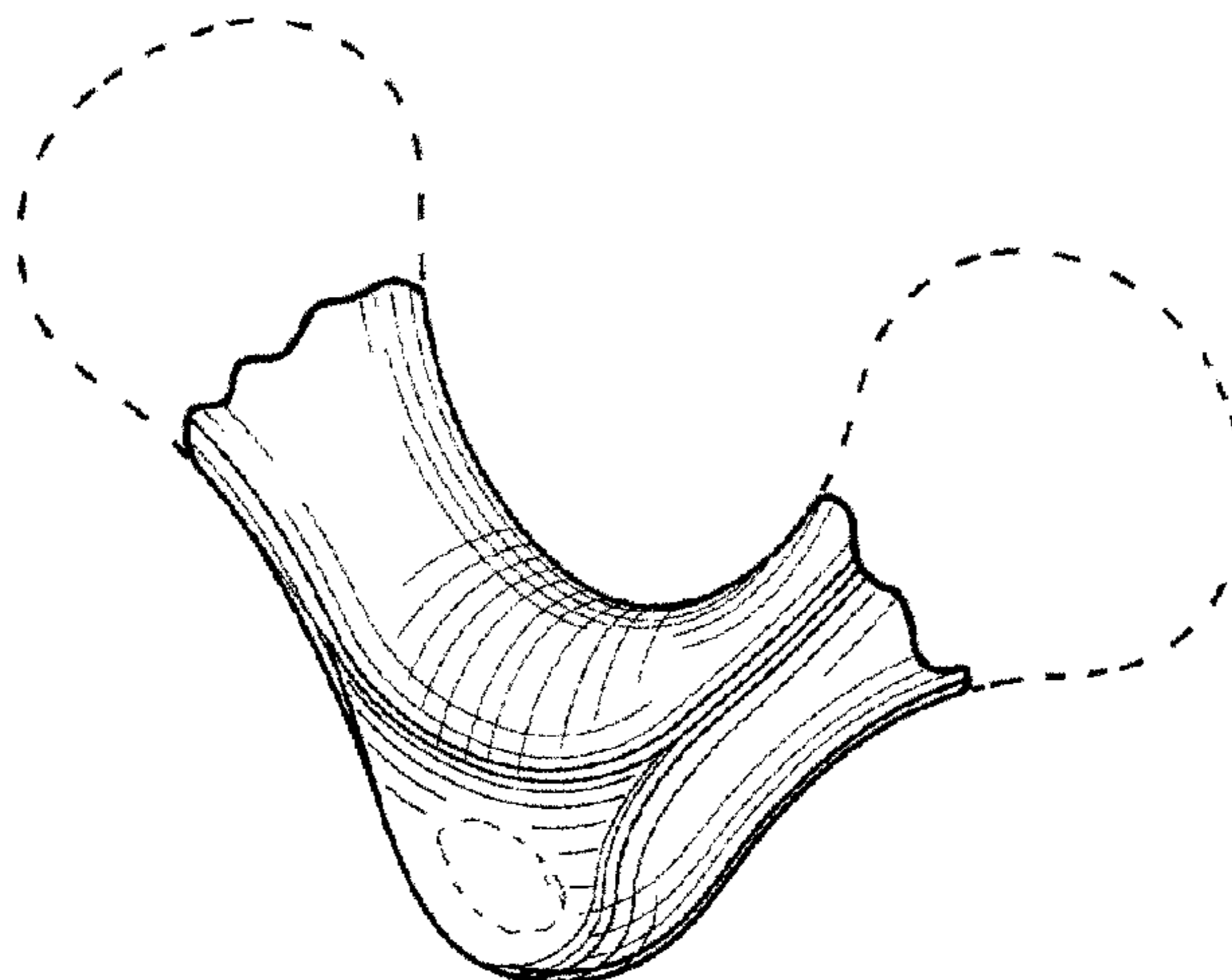

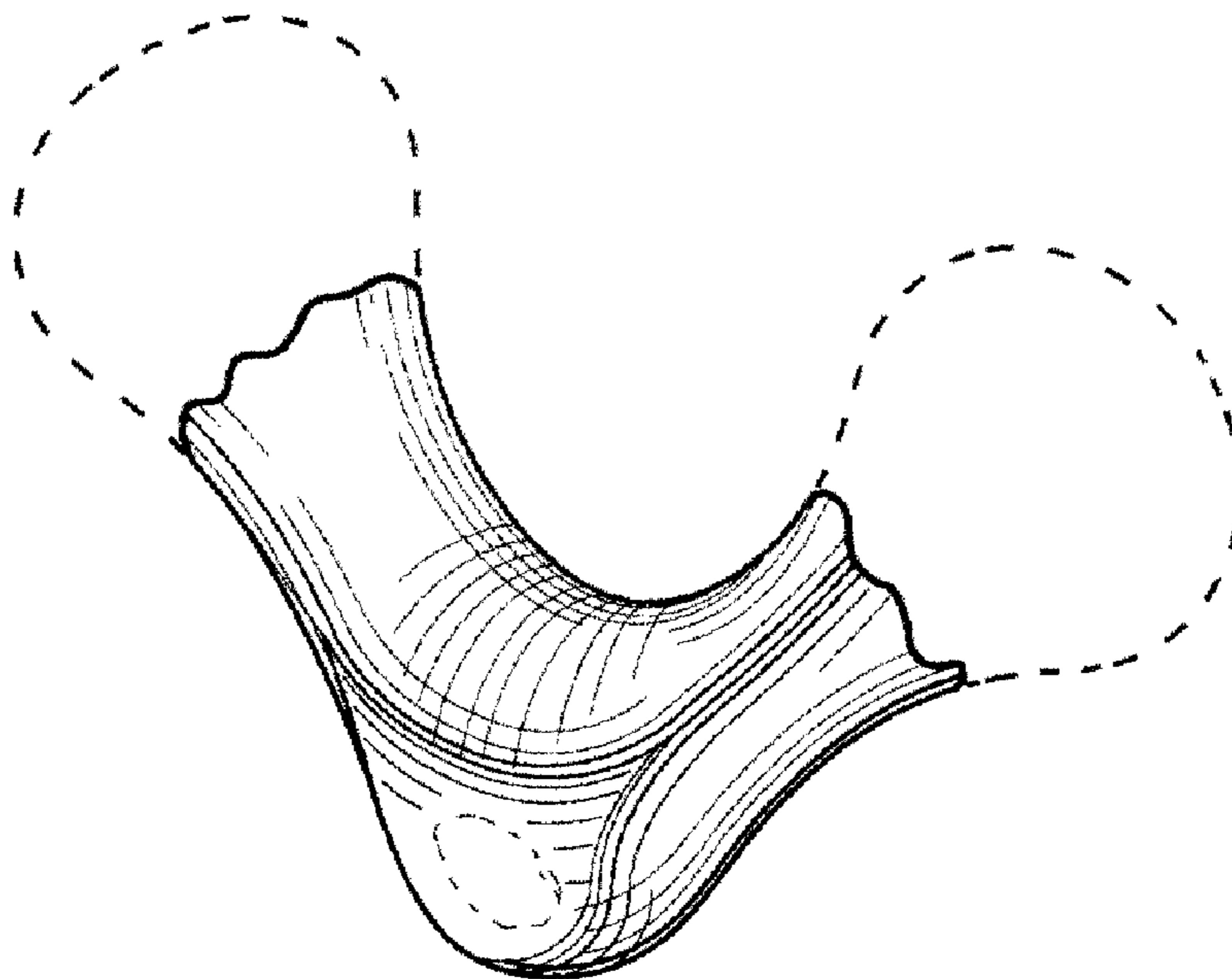

FIG. 1

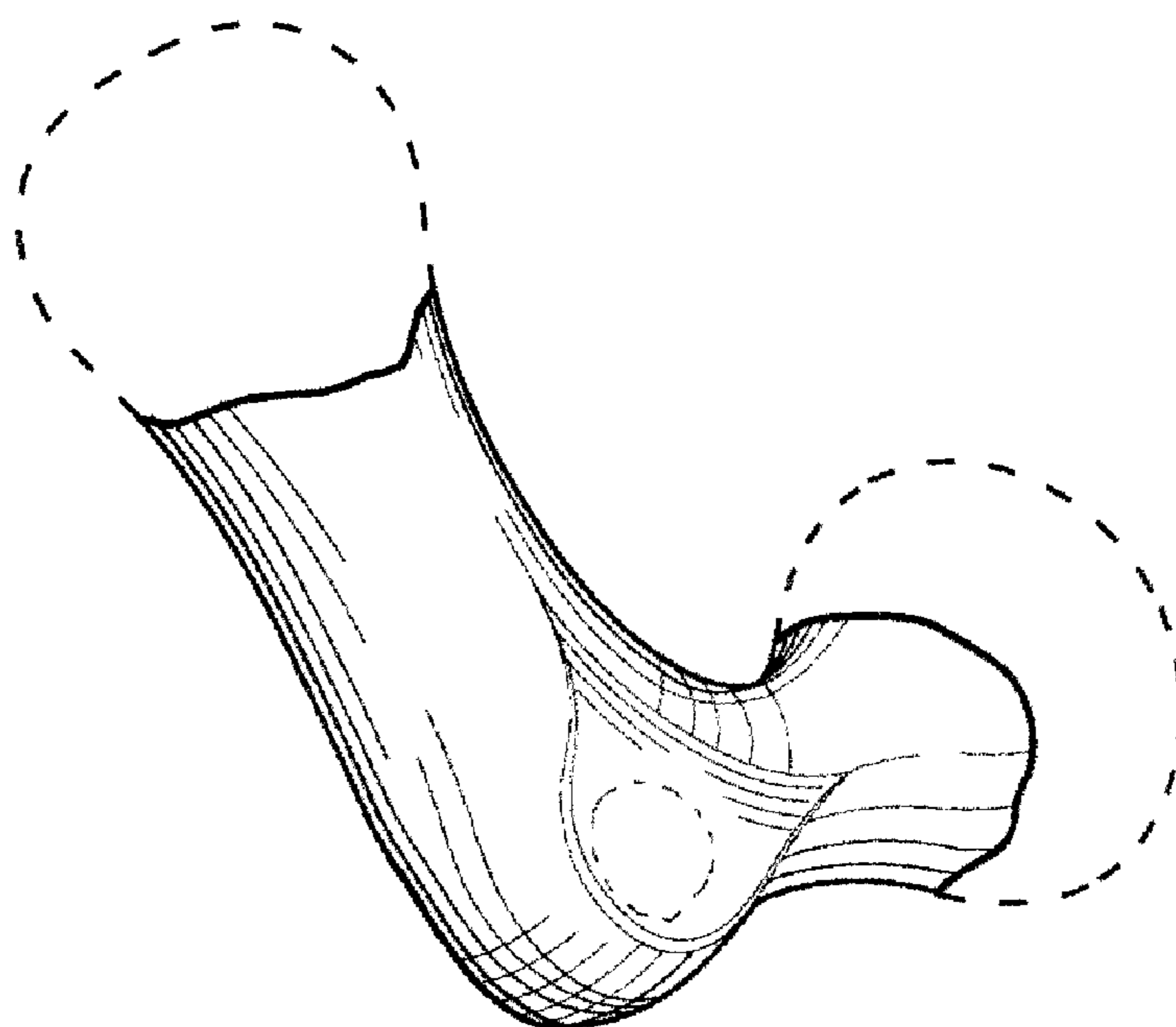

FIG. 2

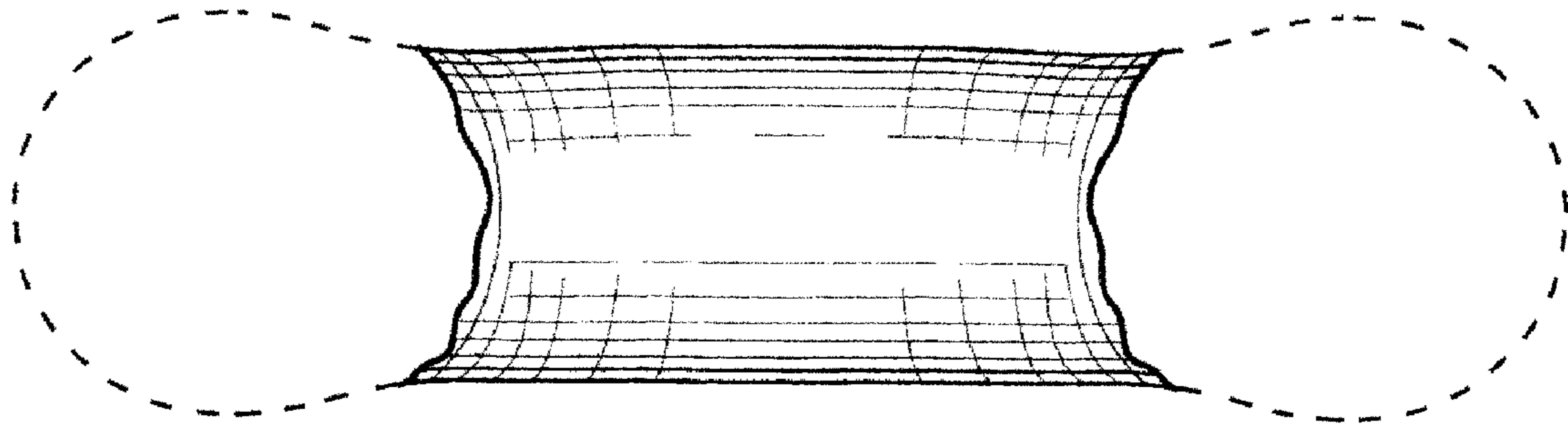

FIG. 3

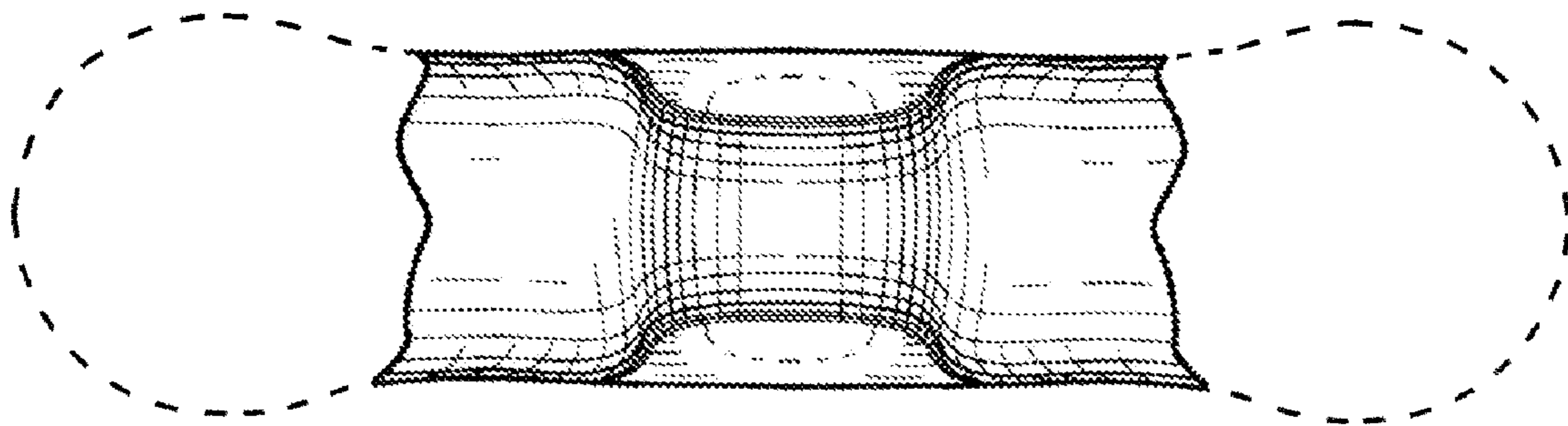

FIG. 4

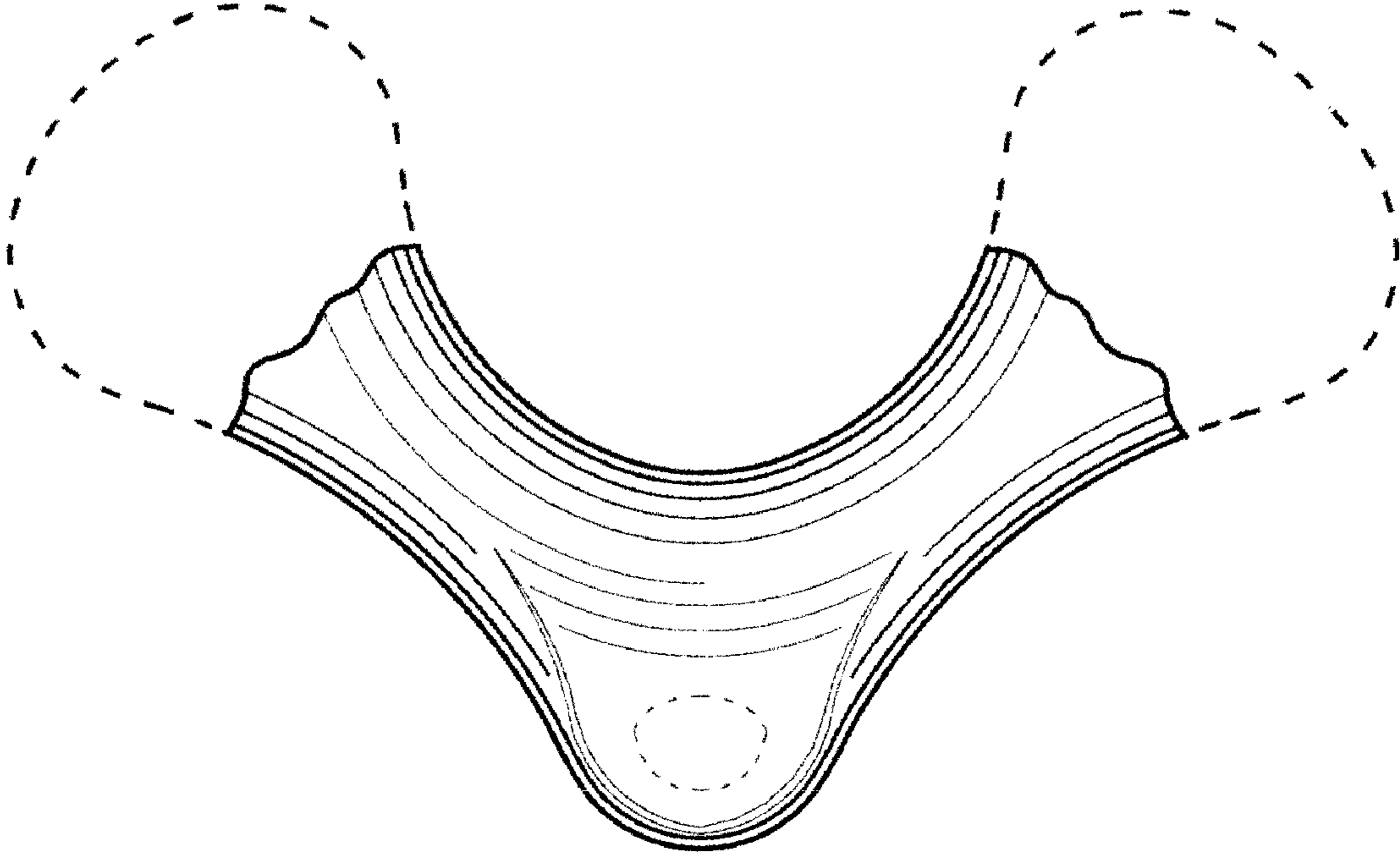

FIG. 5

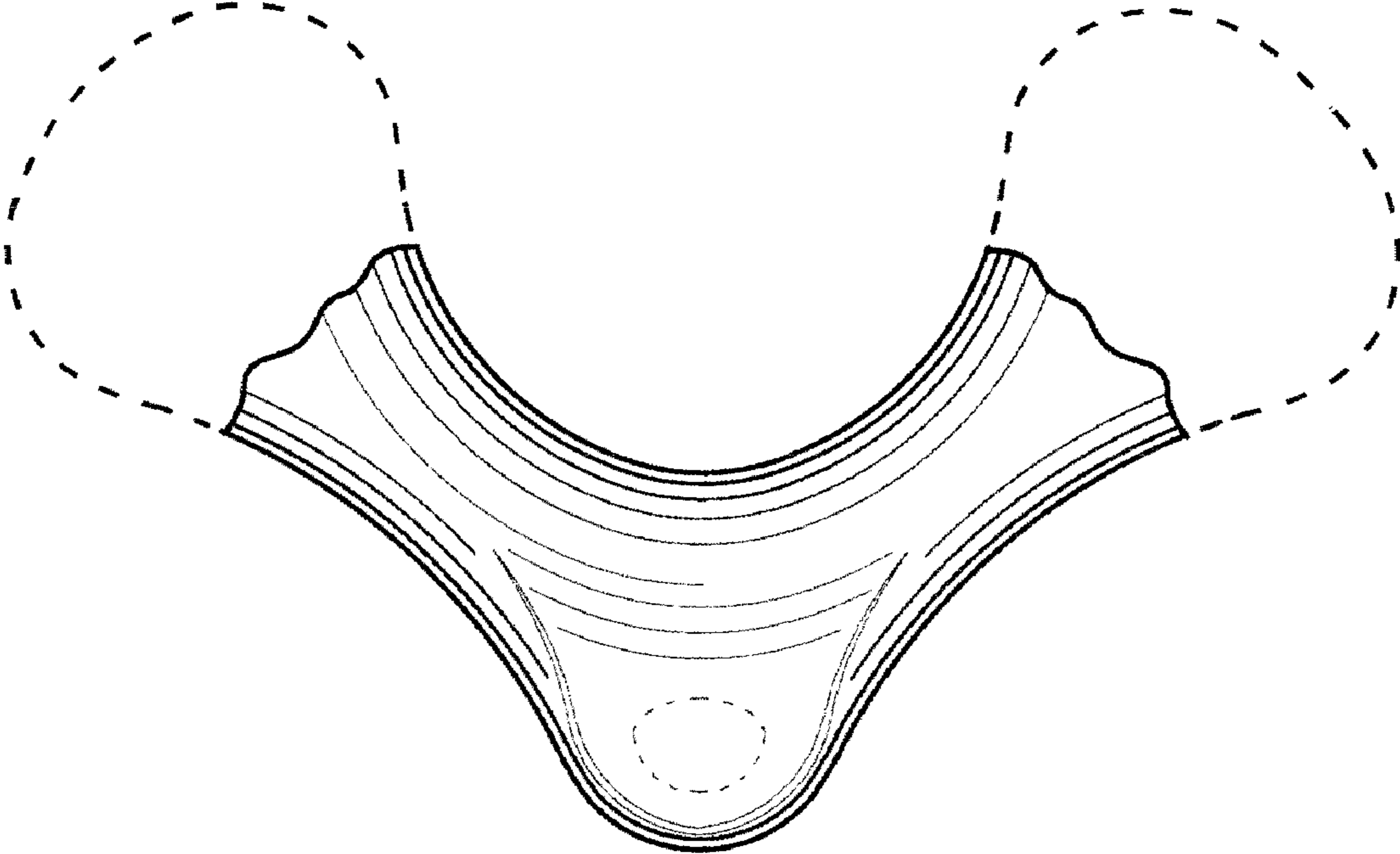

FIG. 6

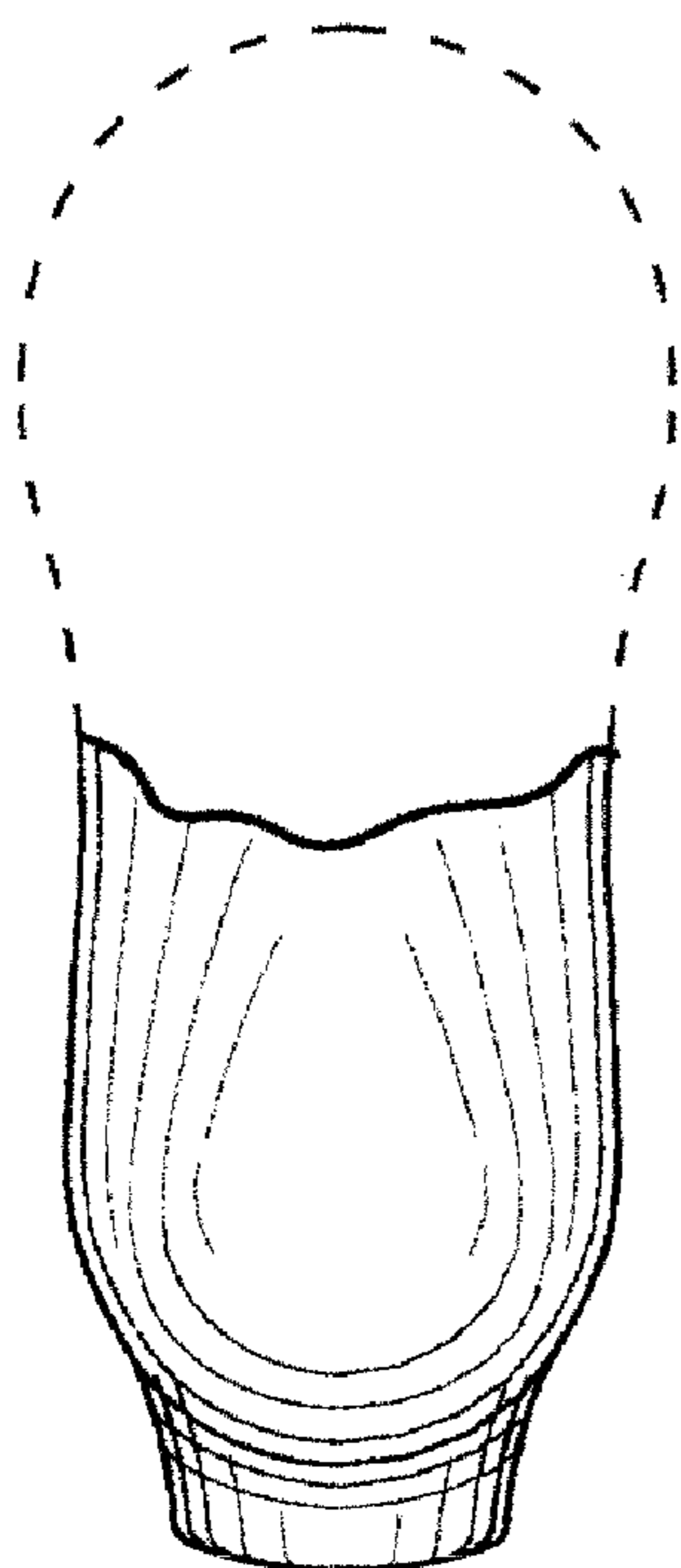

FIG. 7

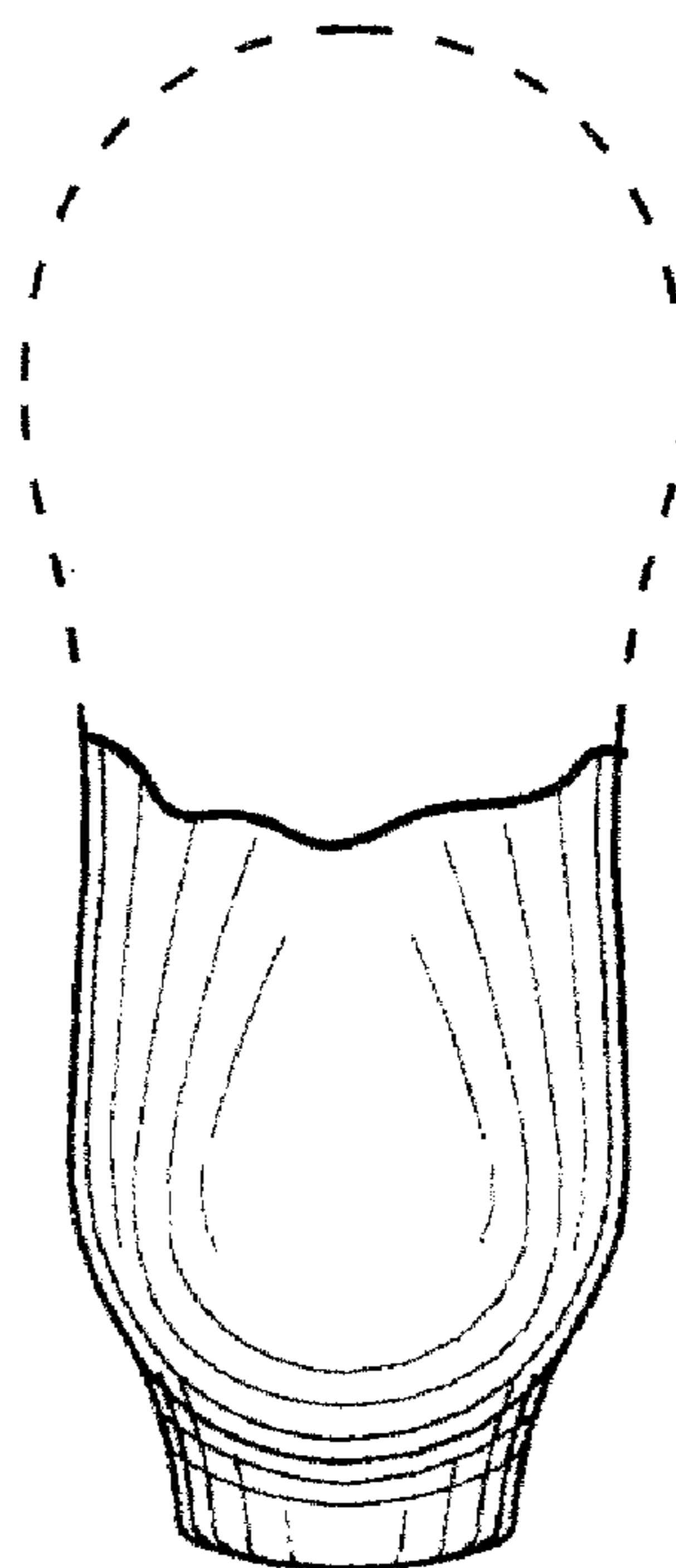

FIG. 8