



US00D641051S

(12) **United States Design Patent**
Flores Saucedo

(10) **Patent No.:** **US D641,051 S**
(45) **Date of Patent:** **** Jul. 5, 2011**

(54) **SHOE-LIKE TOY**

Primary Examiner — Cynthia M Chin

(76) Inventor: **Gerardo Flores Saucedo**, Mexico DF
(MX)

(57) **CLAIM**

I claim the ornamental design for a shoe-like toy, as shown and described.

(**) Term: **14 Years**

DESCRIPTION

(21) Appl. No.: **29/384,998**

FIG. 1 is an enlarged front perspective view of the base and vamp of the shoe-like toy, with the insert removed for the clarity of illustration;

(22) Filed: **Feb. 7, 2011**

FIG. 2 is another front perspective view thereof, showing my design in use by a kid illustrated in dotted lines;

Related U.S. Application Data

(62) Division of application No. 29/327,643, filed on Nov. 10, 2008, now Pat. No. Des. 635,617.

FIG. 3 is a bottom perspective view thereof, with the vamp removed for the clarity of illustration;

(51) **LOC (9) Cl.** **21-01**

FIG. 4 is a top plan view thereof;

(52) **U.S. Cl.** **D21/421; D2/897**

FIG. 5 is a bottom plan view thereof;

(58) **Field of Classification Search** D21/483,
D21/419, 421, 422; D2/897, 898, 899, 900,
D2/904, 905, 906, 916; 36/7.1 R, 7.5, 7.6,
36/11.5, 62, 122

FIG. 6 is a side elevational view thereof;

FIG. 7 is a front elevational view thereof;

See application file for complete search history.

FIG. 8 is an enlarged perspective view of the insert attached to the front portion of the base, shown separately for the clarity of illustration;

FIG. 9 is a top plan view thereof;

(56) **References Cited**

References Cited

U.S. PATENT DOCUMENTS

2,932,910	A *	4/1960	Brown	36/122
3,032,897	A *	5/1962	Gelineau	36/7.5
D216,140	S *	11/1969	Luther, Jr.	D21/422
D231,379	S *	4/1974	Fields	D21/422
3,829,990	A *	8/1974	Sakamoto	D21/422
D251,080	S *	2/1979	Koblick	D2/916
D285,715	S *	9/1986	Brantingham	D21/422
D381,493	S *	7/1997	Comeau	D2/906
D400,694	S *	11/1998	Kang	D2/916
D423,605	S *	4/2000	Graves	D21/483
D437,476	S *	2/2001	Cavallin et al.	D2/916
D441,037	S *	4/2001	Graves	D21/483
6,751,892	B2 *	6/2004	Chavet et al.	36/7.5
7,500,324	B1 *	3/2009	Power et al.	36/7.5

FIG. 10 is a bottom plan view thereof.

FIG. 11 is a side elevational view thereof.

FIG. 12 is a front elevational view.

FIG. 13 is an enlarged perspective view of the vamp or upper shown separately for the clarity of illustration;

FIG. 14 is a top plan view thereof;

FIG. 15 is an end elevational view thereof;

FIG. 16 is a side elevational view thereof; and,

FIG. 17 is a front perspective view of the shoe-like toy showing my new design, comprised of the base, vamp and insert of FIGS. 1-16, being shown in use by a kid illustrated in dotted lines.

The broken/dotted lines represent portions of the shoe-like toy that form no part of the claim.

* cited by examiner

1 Claim, 5 Drawing Sheets

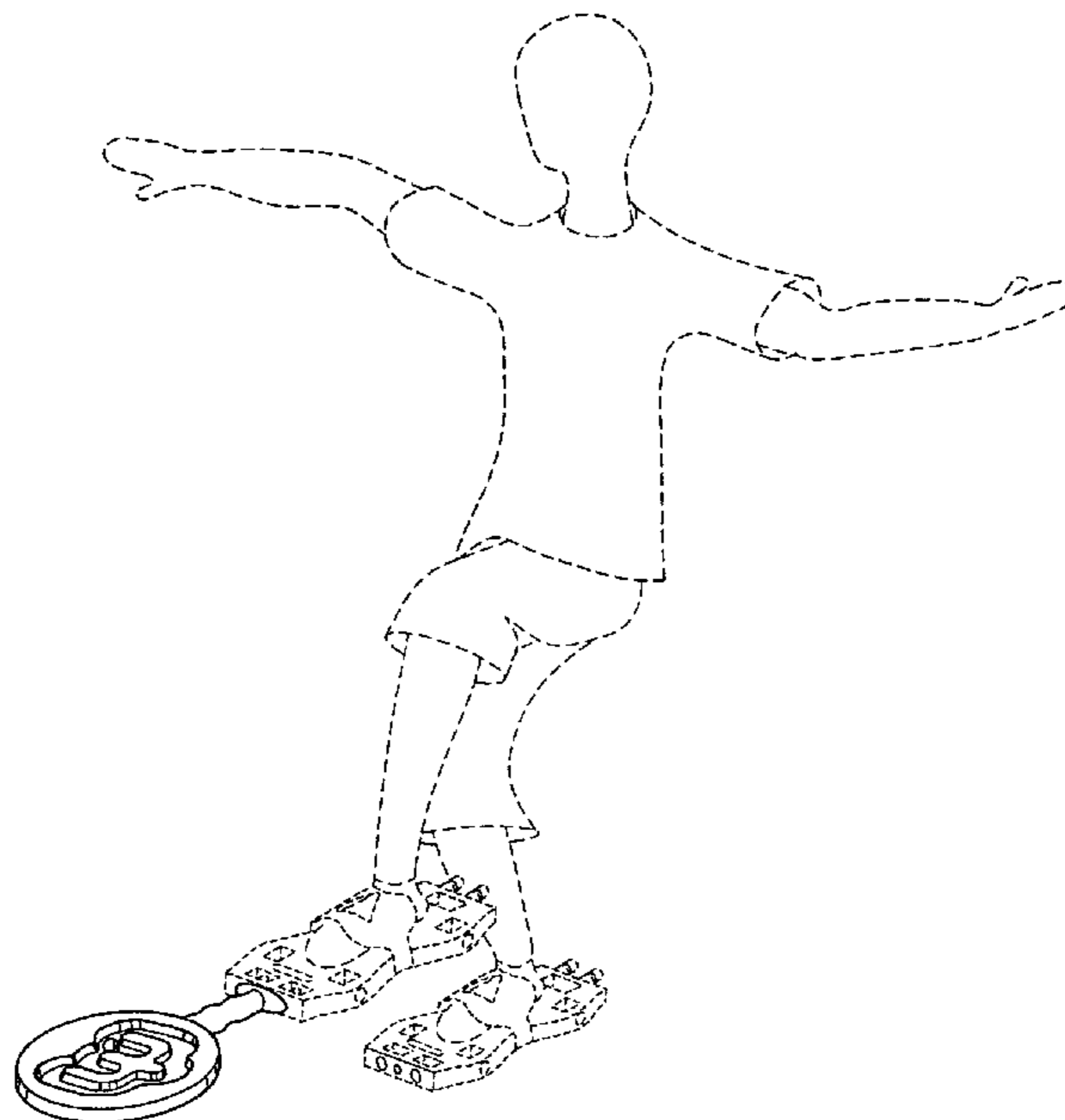

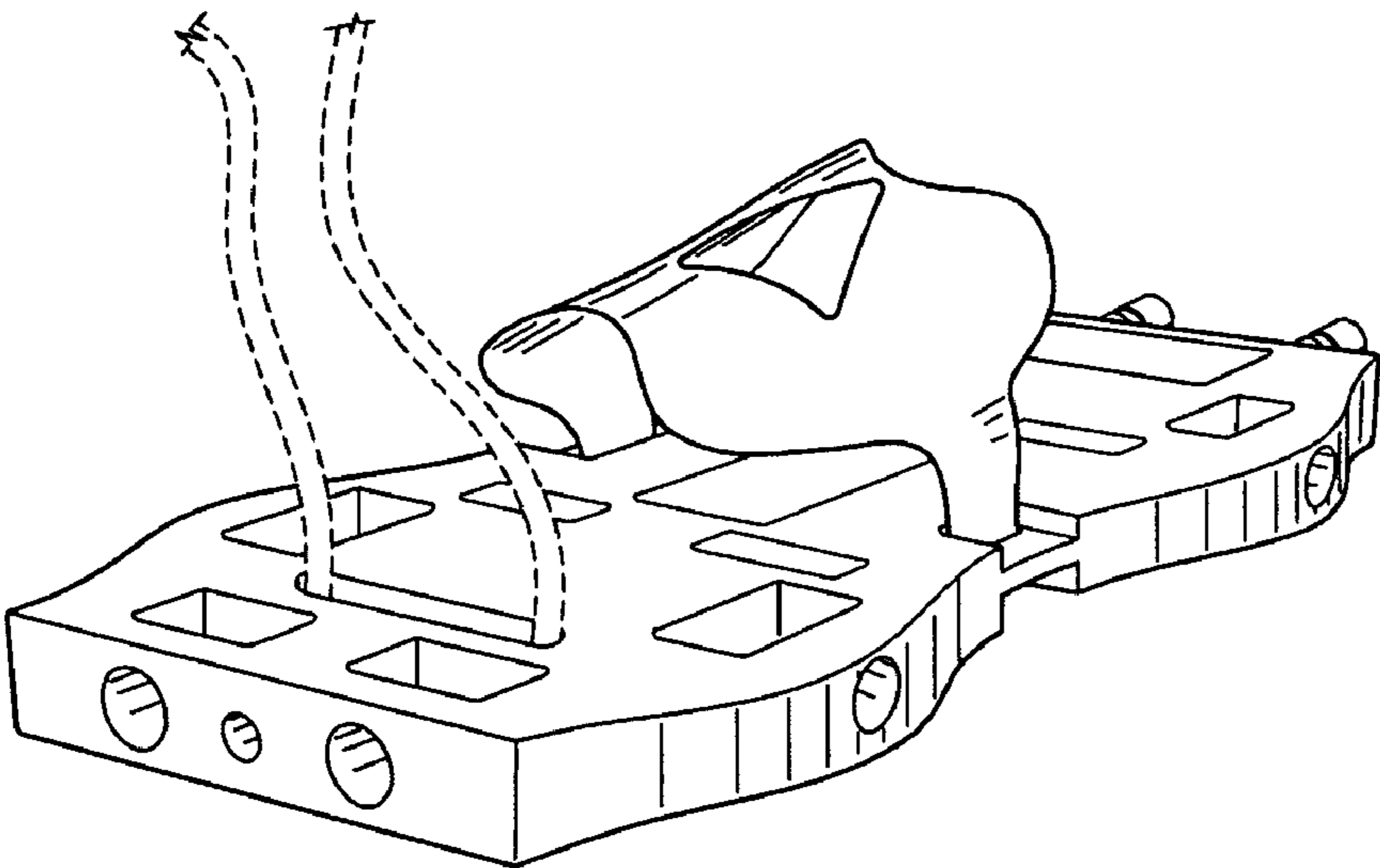

Fig.1

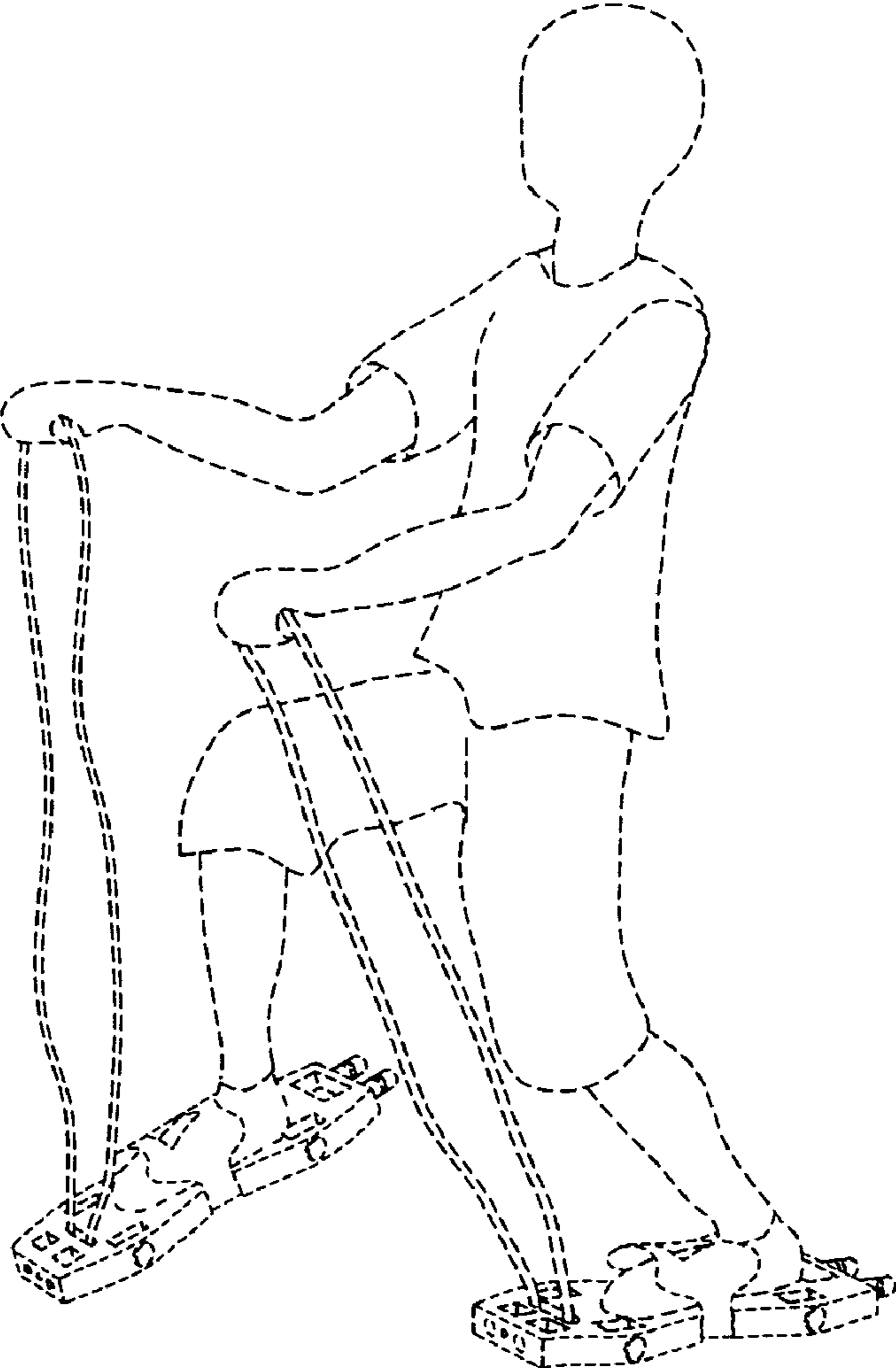

Fig.2

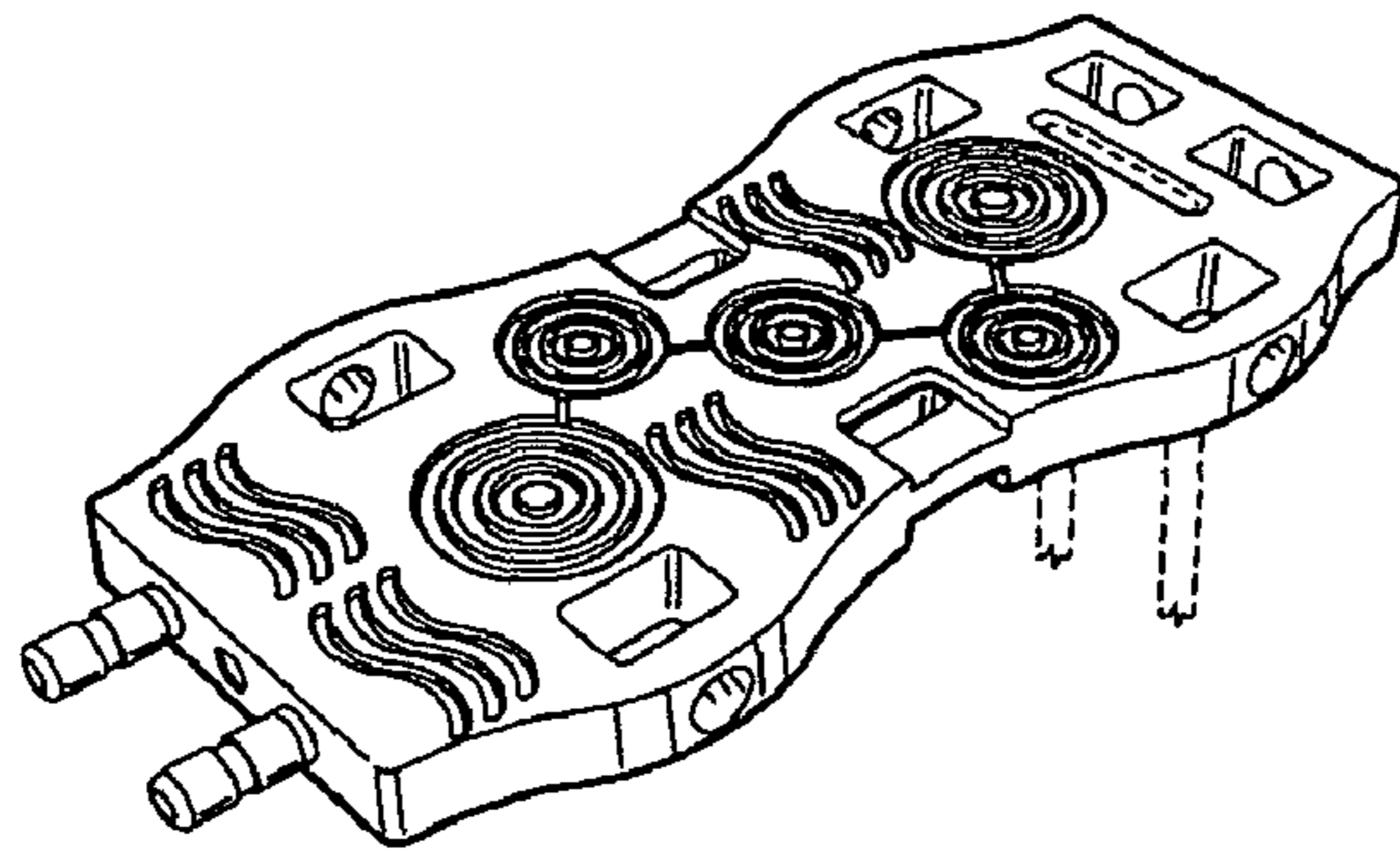

Fig.3

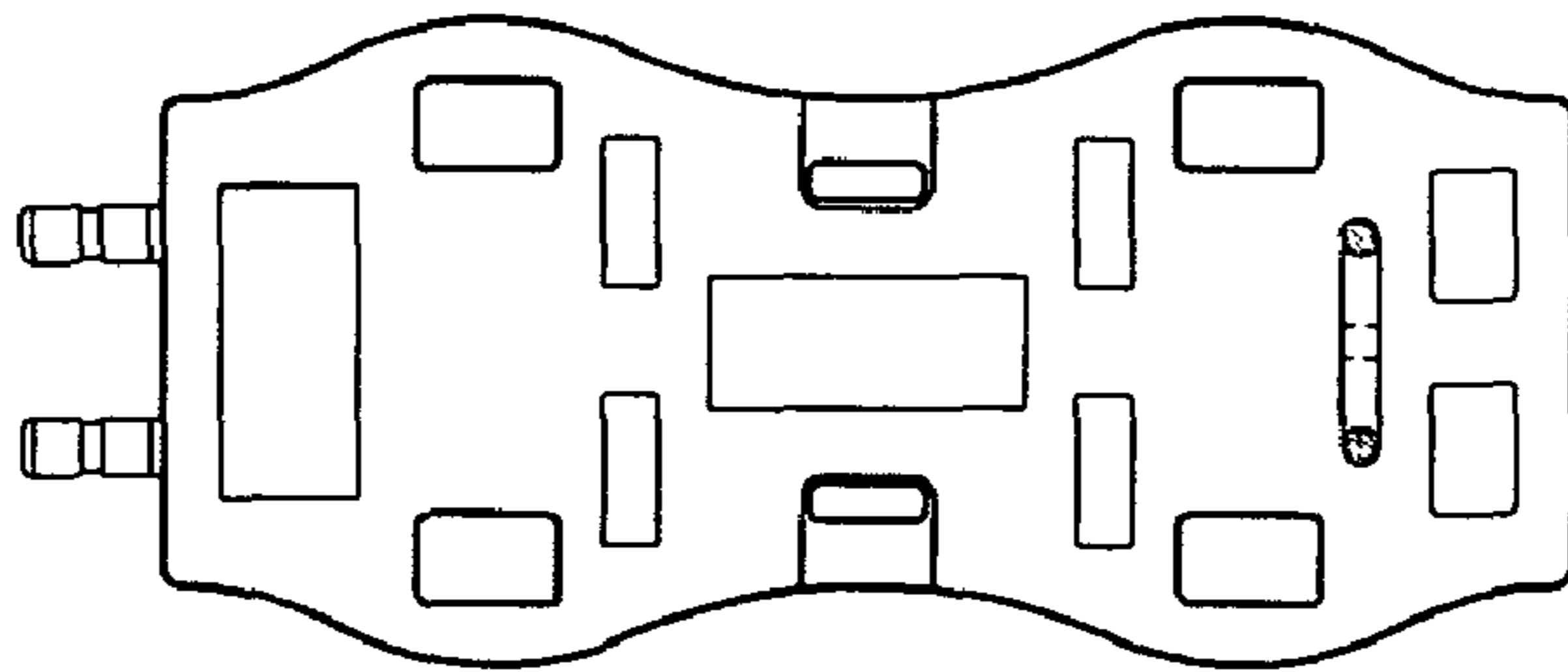

Fig.4

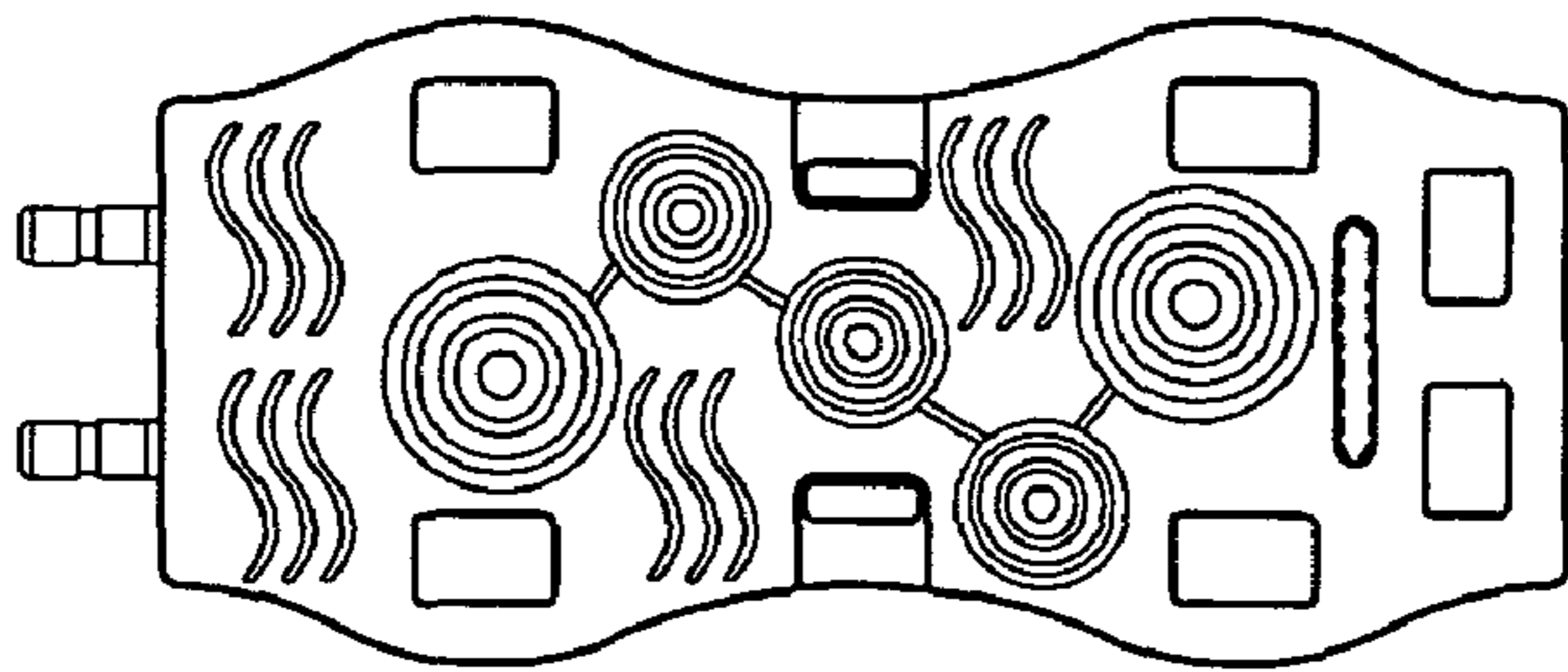

Fig.5

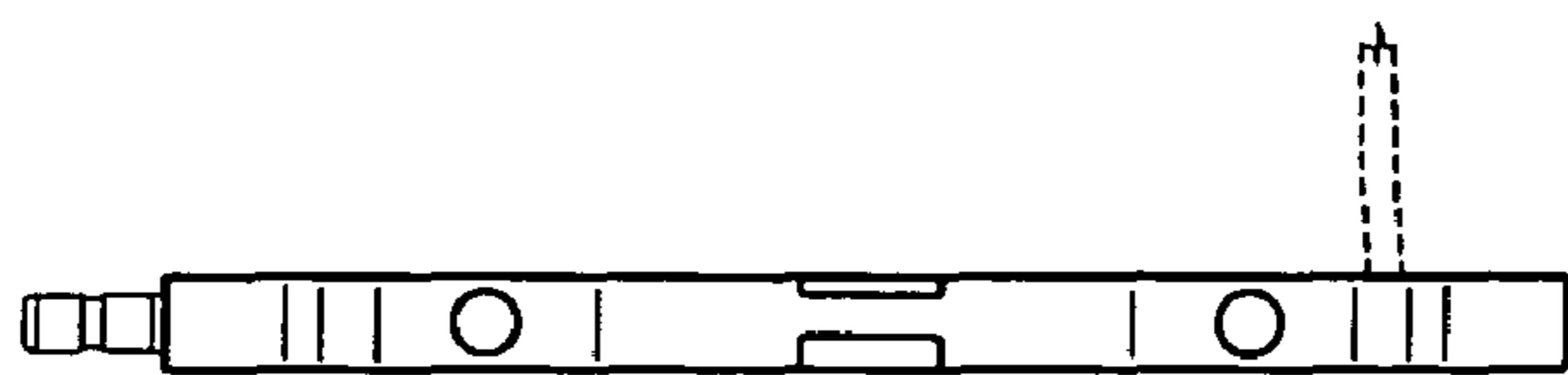

Fig.6

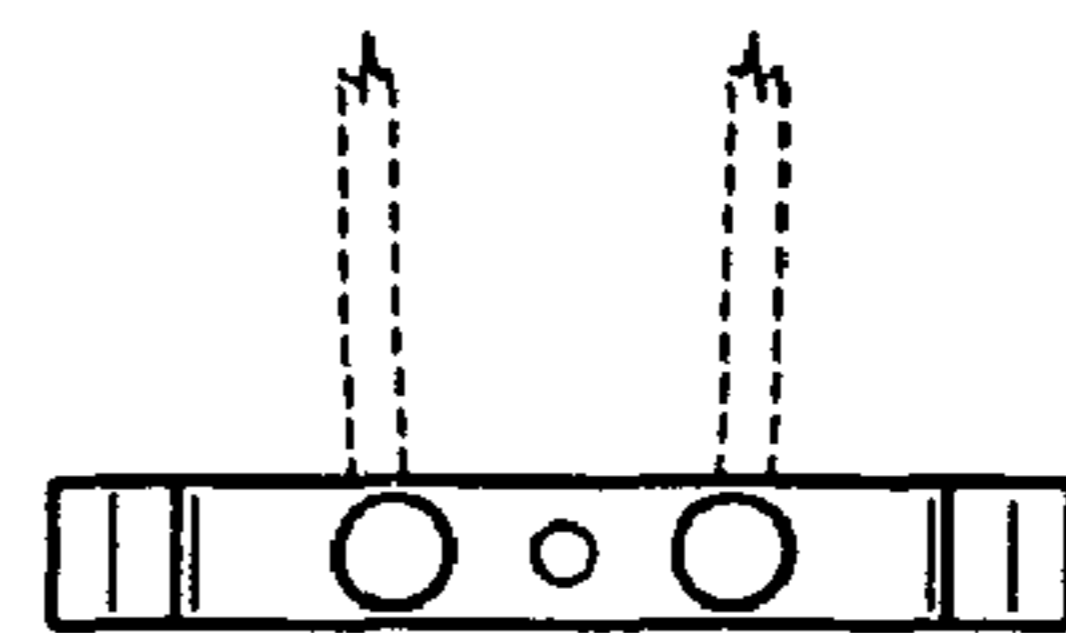

Fig.7

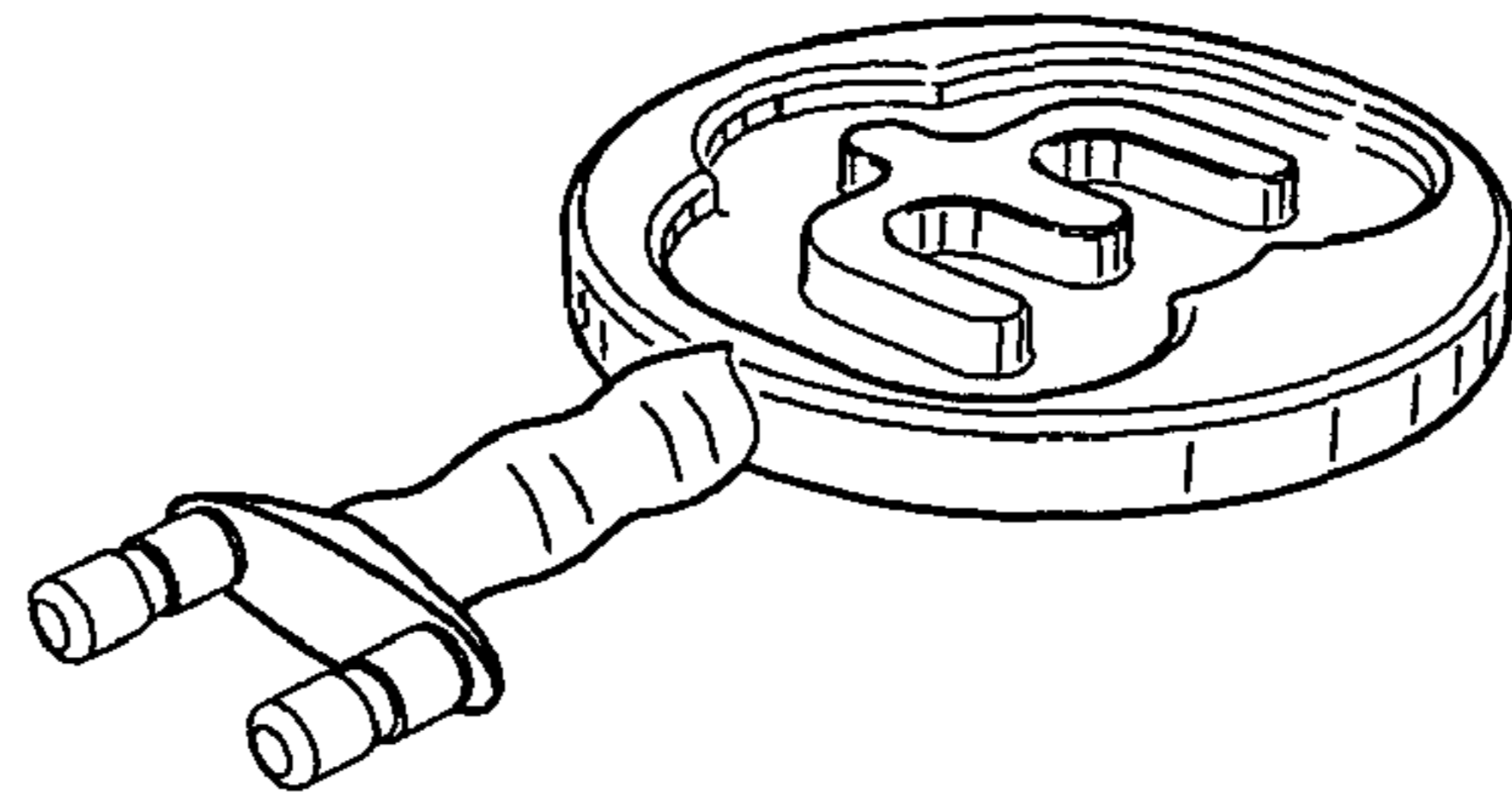

Fig. 8

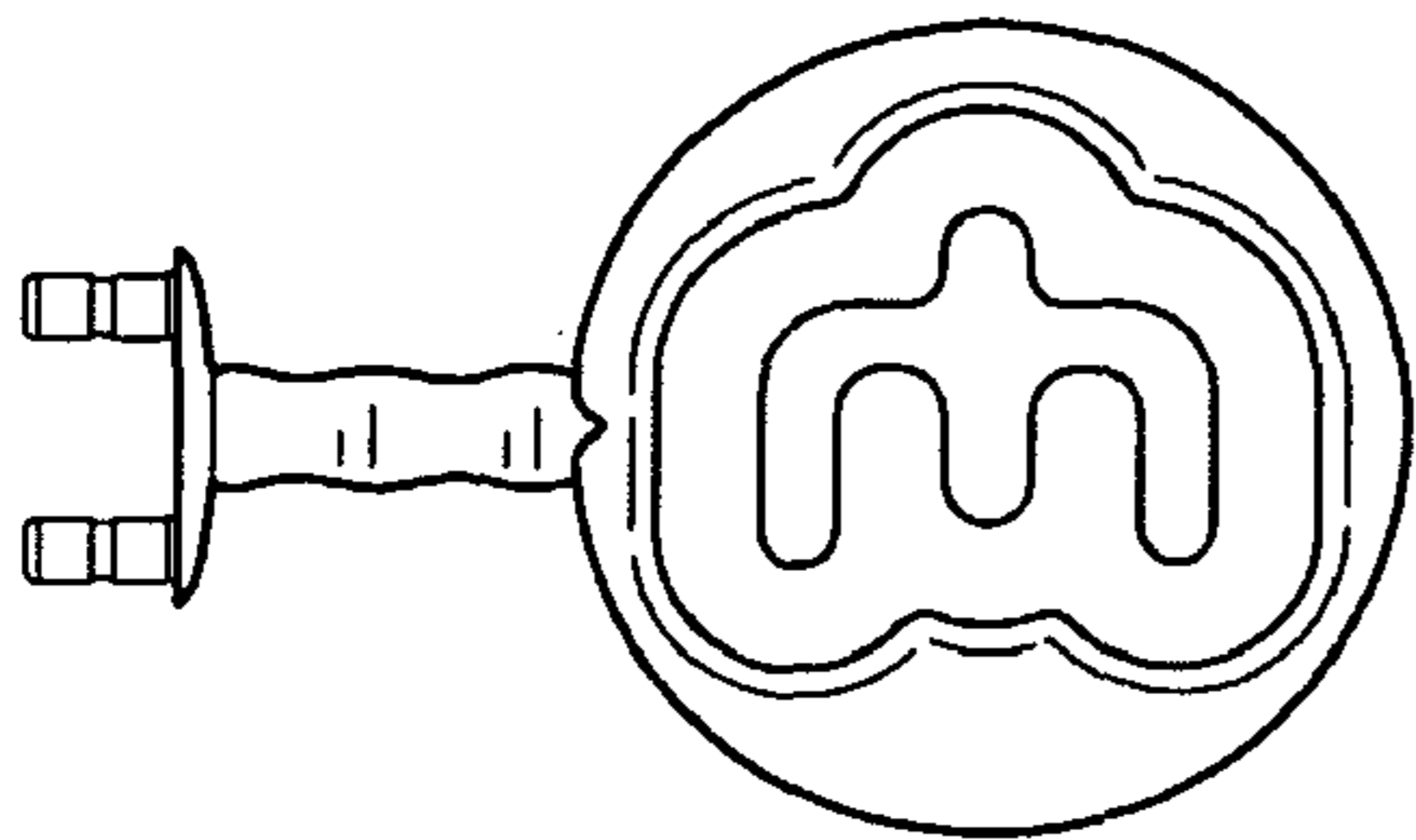

Fig. 9

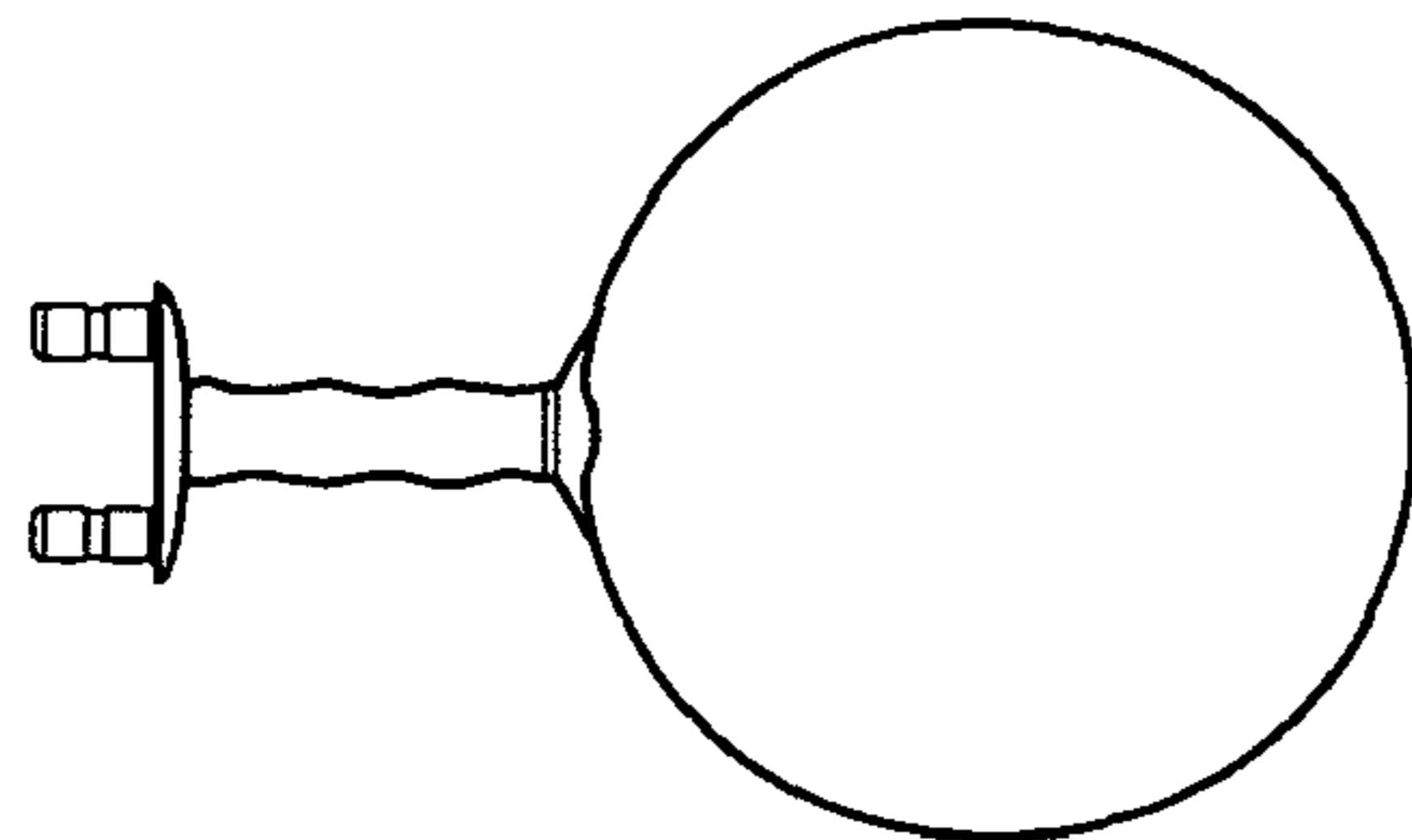

Fig. 10



Fig. 11



Fig. 12

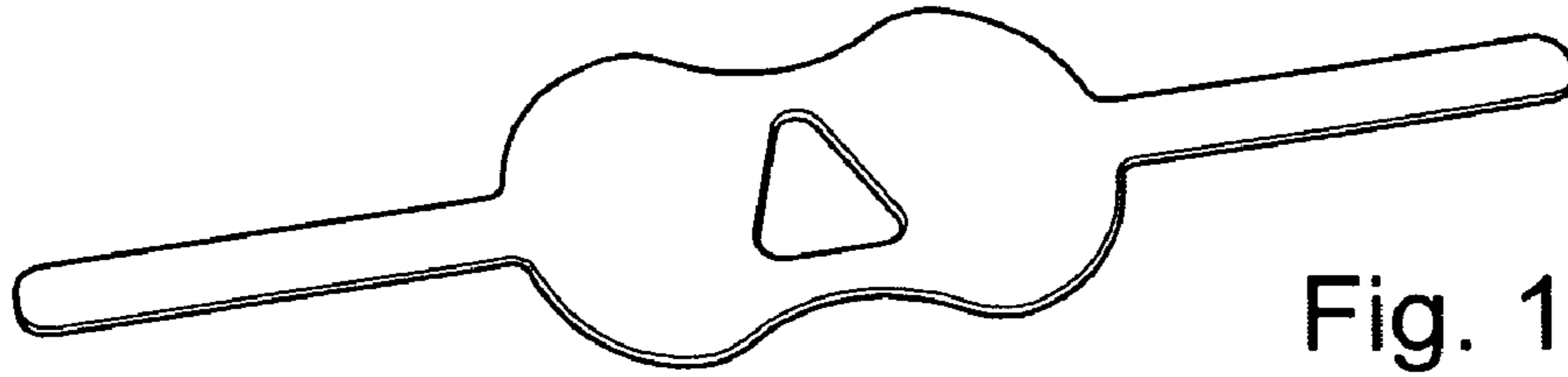

Fig. 13

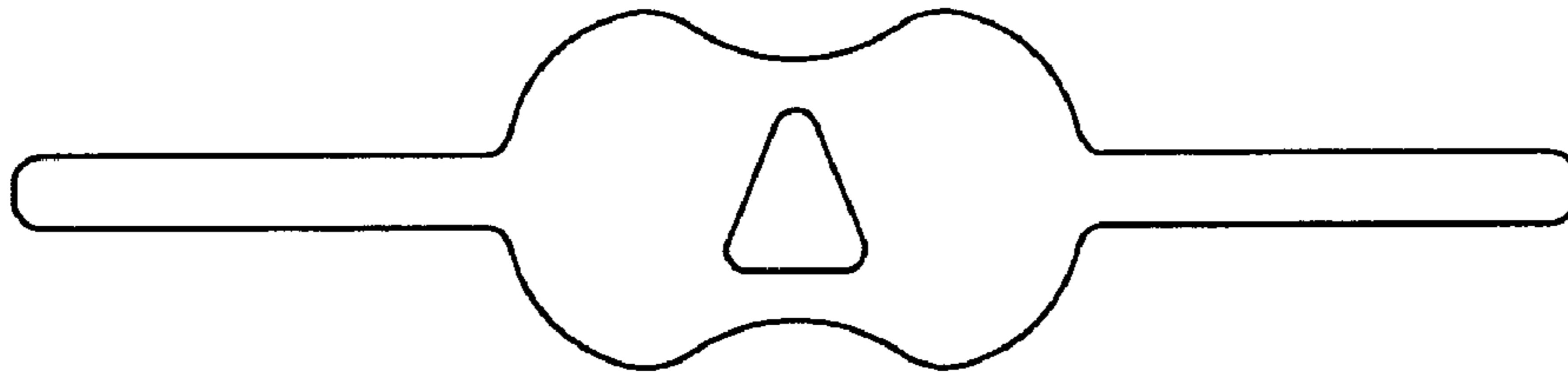

Fig. 14



Fig. 15



Fig. 16

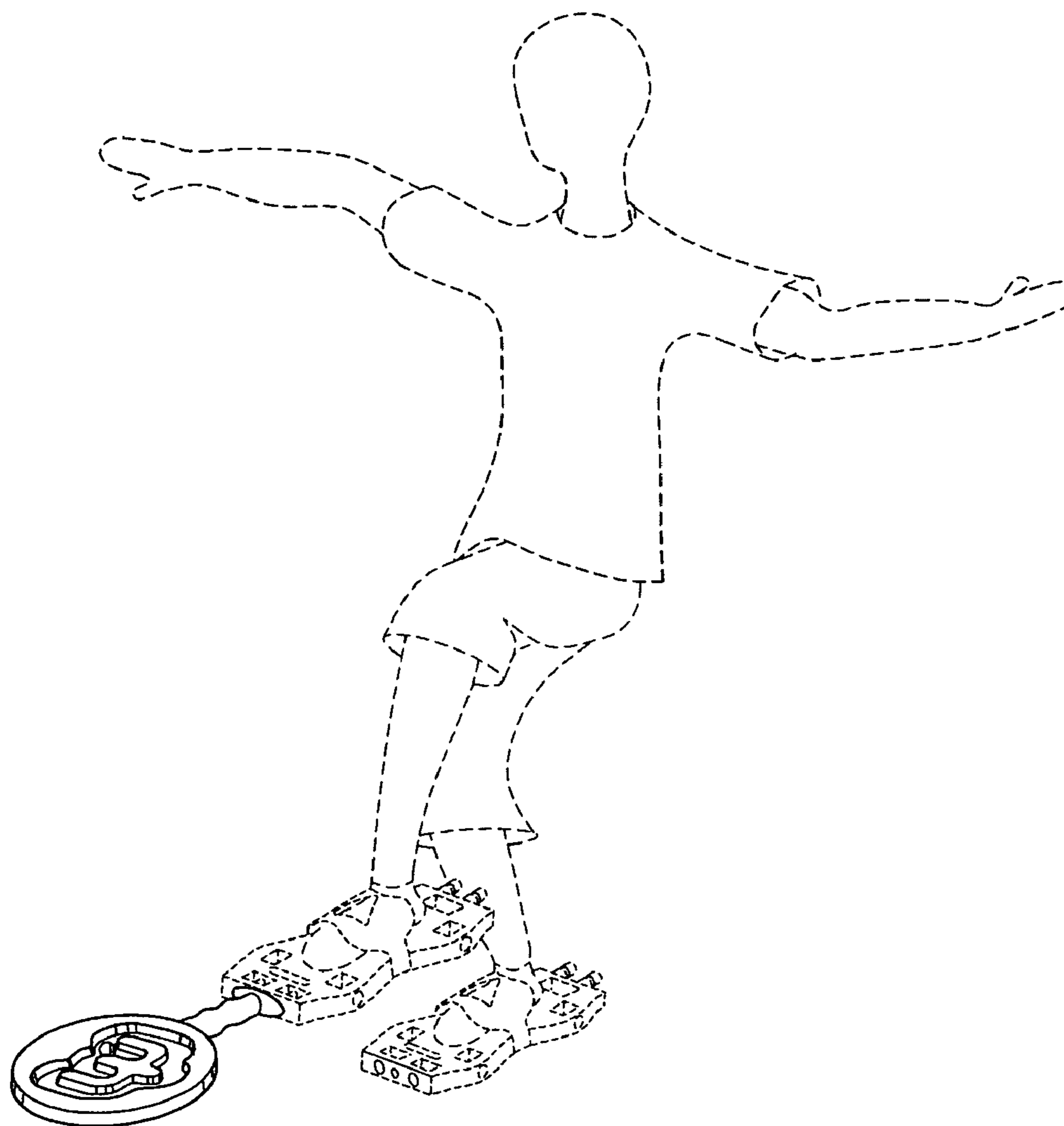

Fig.17