



US00D640981S

(12) **United States Design Patent**
Presz, Jr. et al.

(10) **Patent No.:** **US D640,981 S**

(45) **Date of Patent:** **** Jul. 5, 2011**

(54) **WIND TURBINE**

(75) Inventors: **Walter M. Presz, Jr.**, Wilbraham, MA (US); **Michael J. Werle**, West Hartford, CT (US)

(73) Assignee: **Flodesign Wind Turbine Corp.**, Wilbraham, MA (US)

(**) Term: **14 Years**

(21) Appl. No.: **29/378,838**

(22) Filed: **Nov. 10, 2010**

(51) **LOC (9) Cl.** **13-01**

(52) **U.S. Cl.** **D13/115**

(58) **Field of Classification Search** D13/115, D13/118, 122, 199; D12/344, 345; D15/1, D15/199; D21/458; 290/52, 54, 55; 415/916; 416/24, 31, 37, 38, 132 B, 132 R, 141, 142, 416/176, 177, 196 A

See application file for complete search history.

(56) **References Cited**

U.S. PATENT DOCUMENTS

D252,877 S * 9/1979 Hanson D15/1
4,297,076 A * 10/1981 Donham et al. 416/37
D267,951 S * 2/1983 Smith D15/1
4,398,096 A * 8/1983 Faurholtz 290/55

D305,419 S * 1/1990 Korneski D13/115
6,168,373 B1 * 1/2001 Vauthier 415/7
D487,060 S * 2/2004 Ehrenberger D13/115
D517,986 S * 3/2006 Wobben D13/115
D543,495 S * 5/2007 Williams D12/345

* cited by examiner

Primary Examiner — Stella Reid

Assistant Examiner — Derrick Holland

(74) *Attorney, Agent, or Firm* — Richard M. Klein; Fay Sharpe LLP

(57) **CLAIM**

The ornamental design for a wind turbine, as shown and described.

DESCRIPTION

FIG. 1 is a front view of the wind turbine;
FIG. 2 is a left side view of the wind turbine;
FIG. 3 is a rear view of the wind turbine;
FIG. 4 is a right side view the wind turbine;
FIG. 5 is a top view of the wind turbine;
FIG. 6 is a bottom view of the wind turbine;
FIG. 7 is a top front left perspective view of the wind turbine;
and,
FIG. 8 is a top rear left perspective view of the wind turbine.
The broken lines shown represent unclaimed subject matter and form no part of the claimed design.

1 Claim, 4 Drawing Sheets

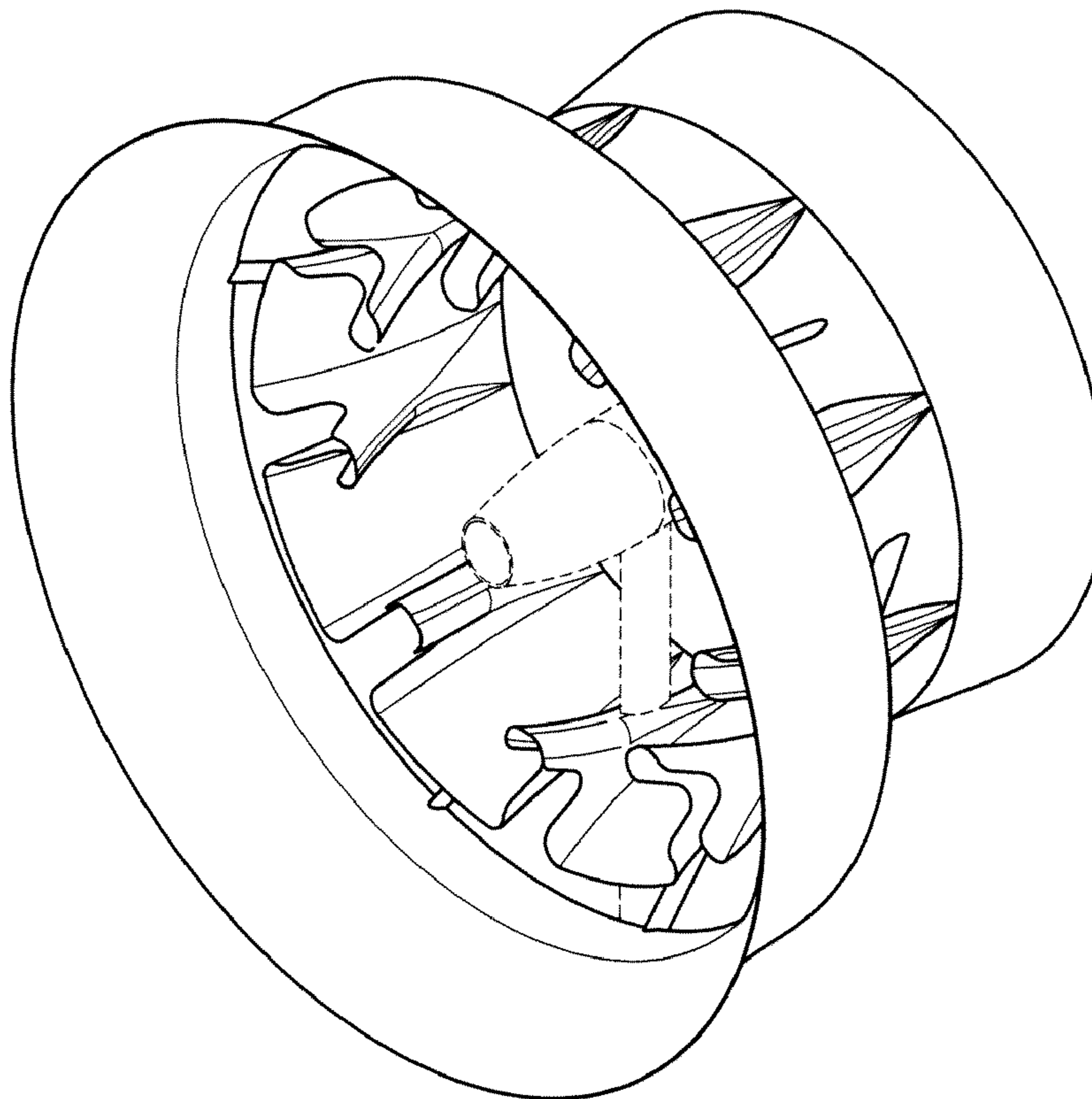

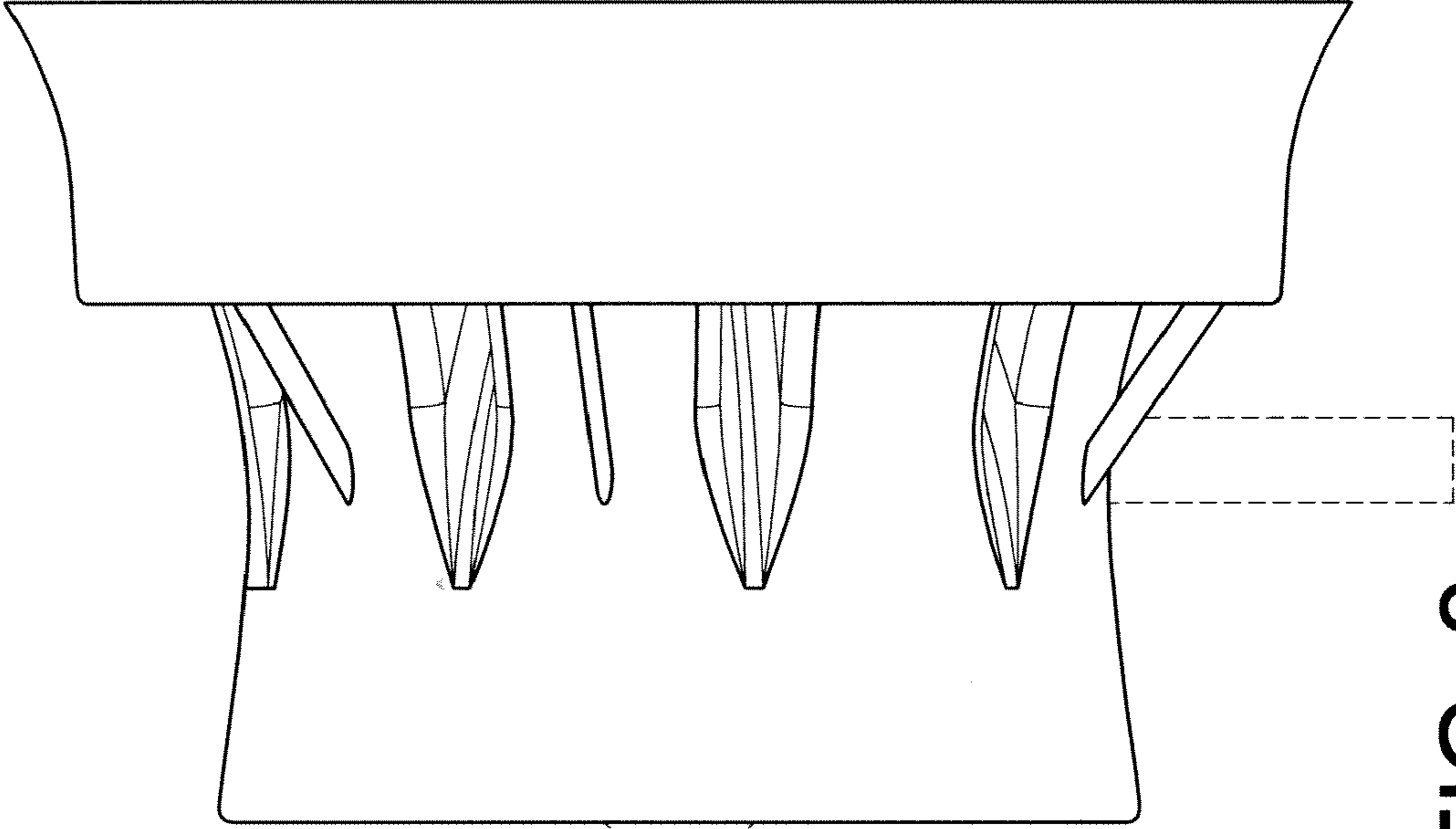

FIG. 2

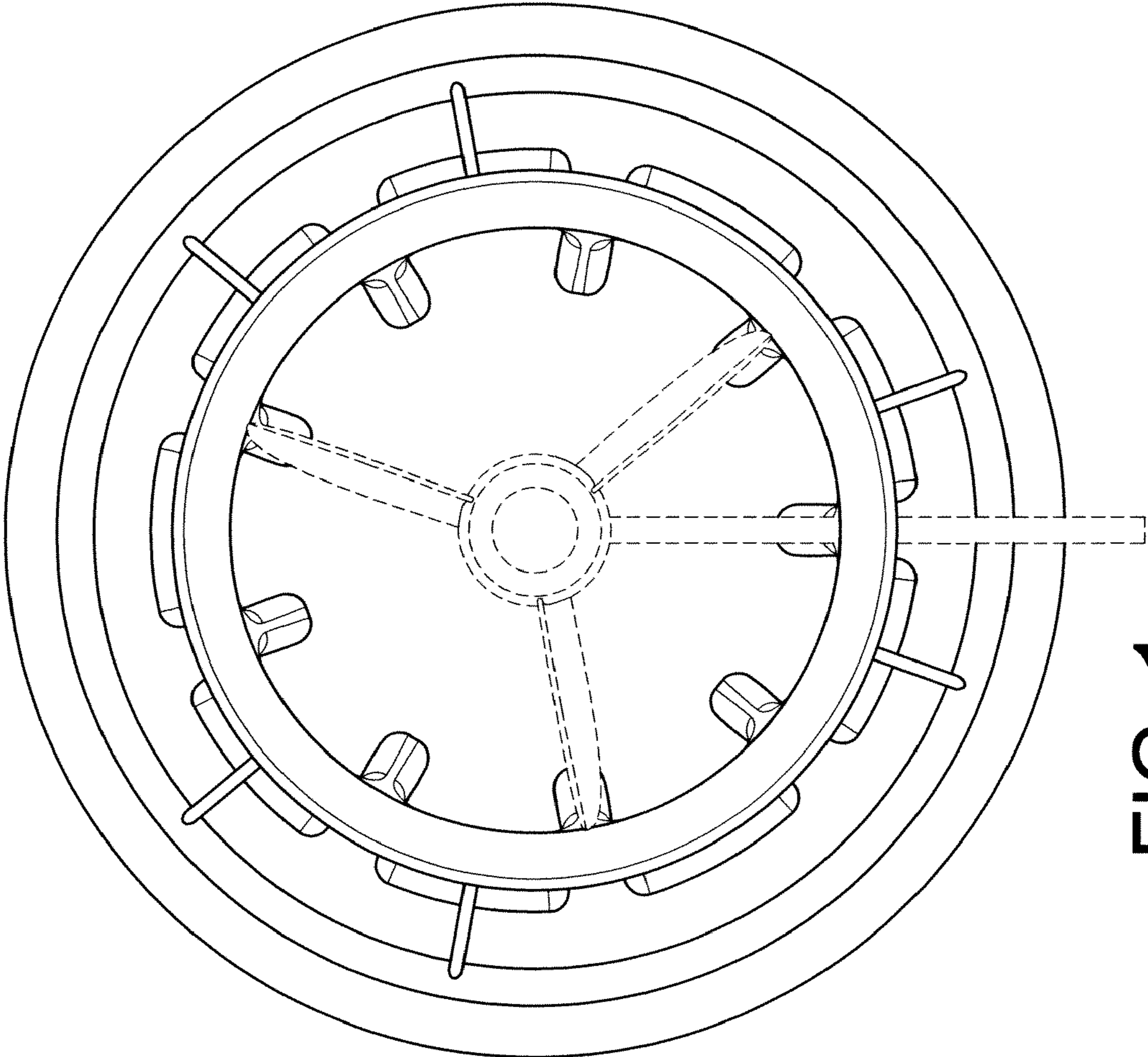

FIG. 1

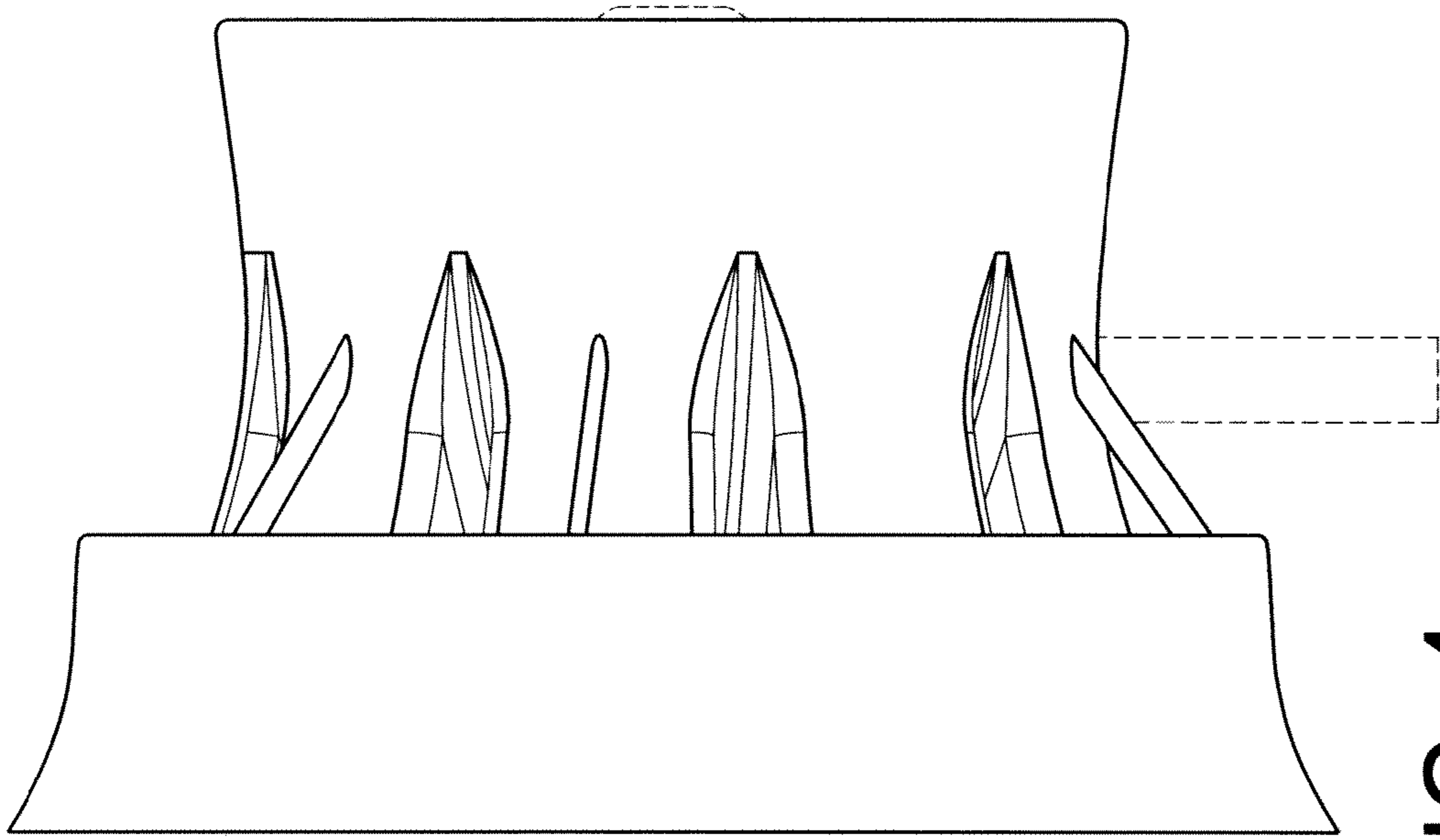

FIG. 4

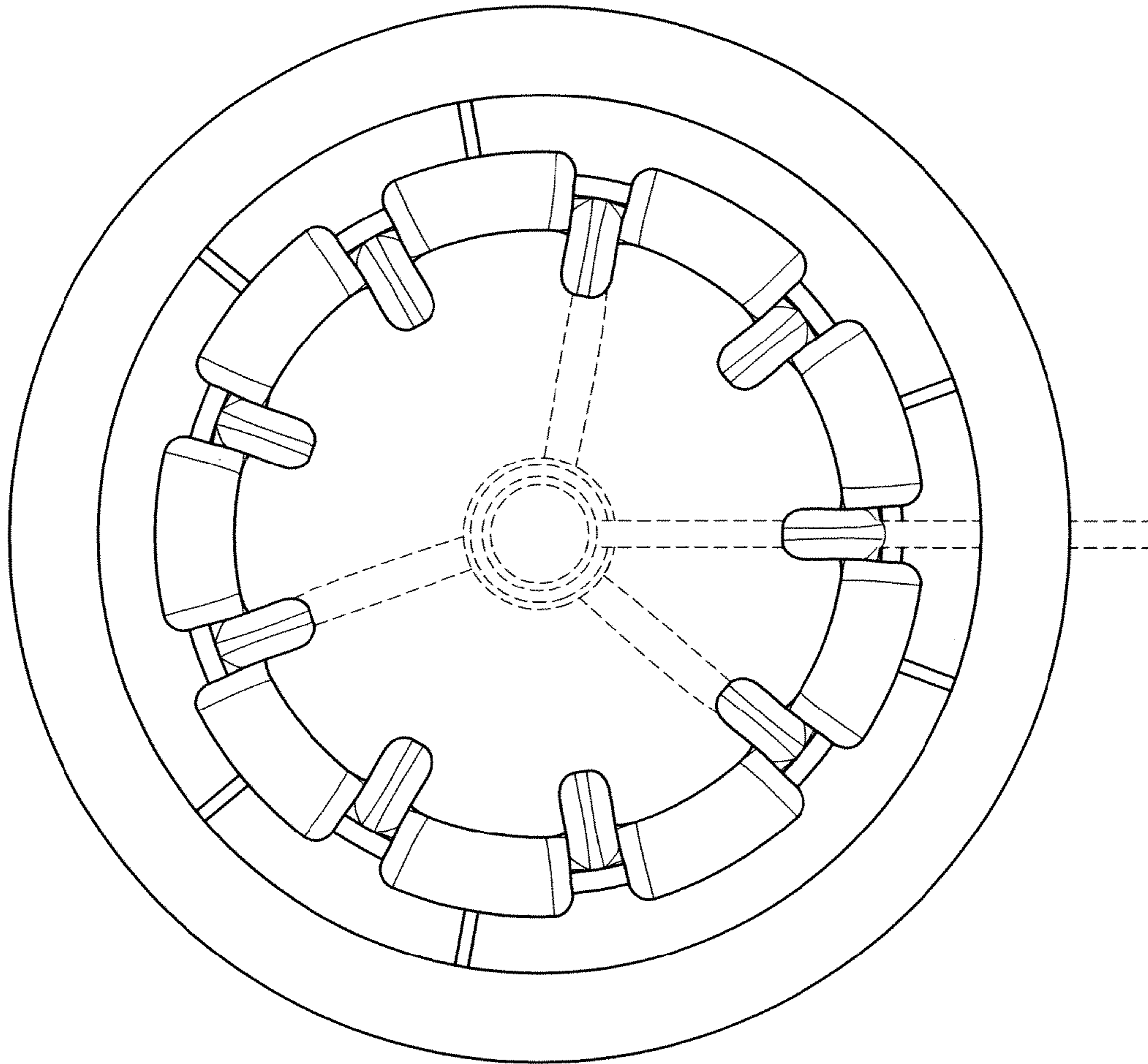

FIG. 3

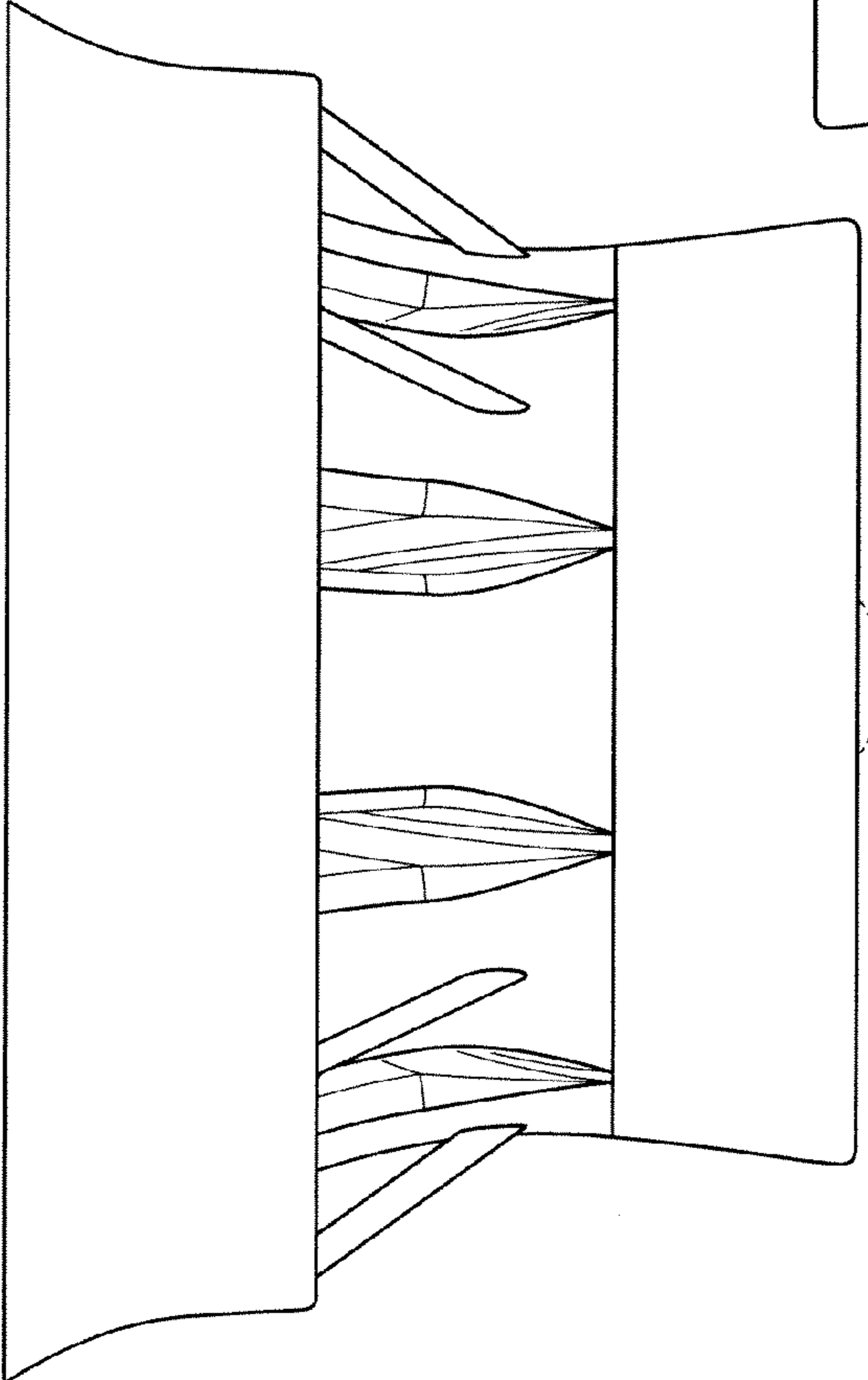

FIG. 5

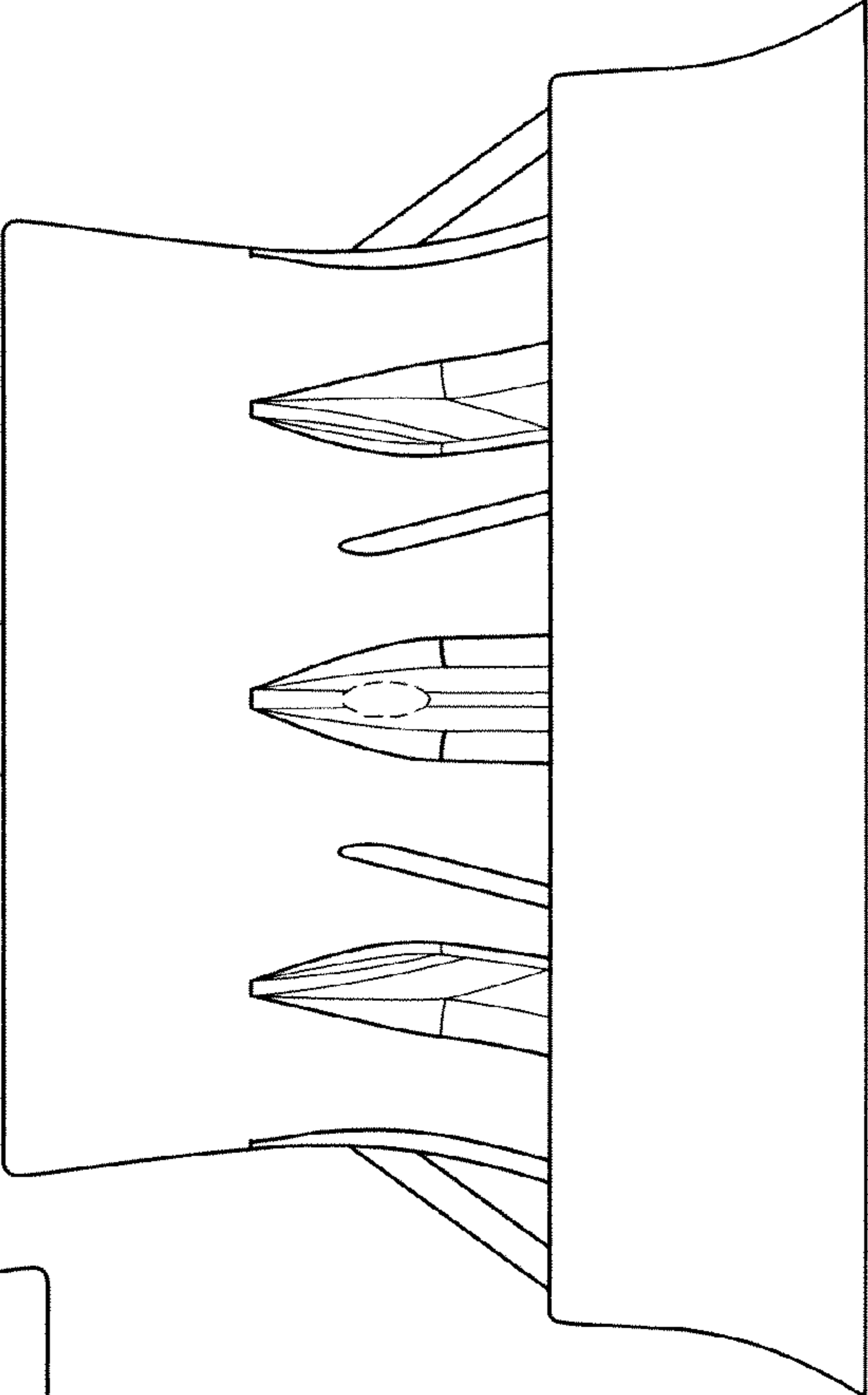

FIG. 6

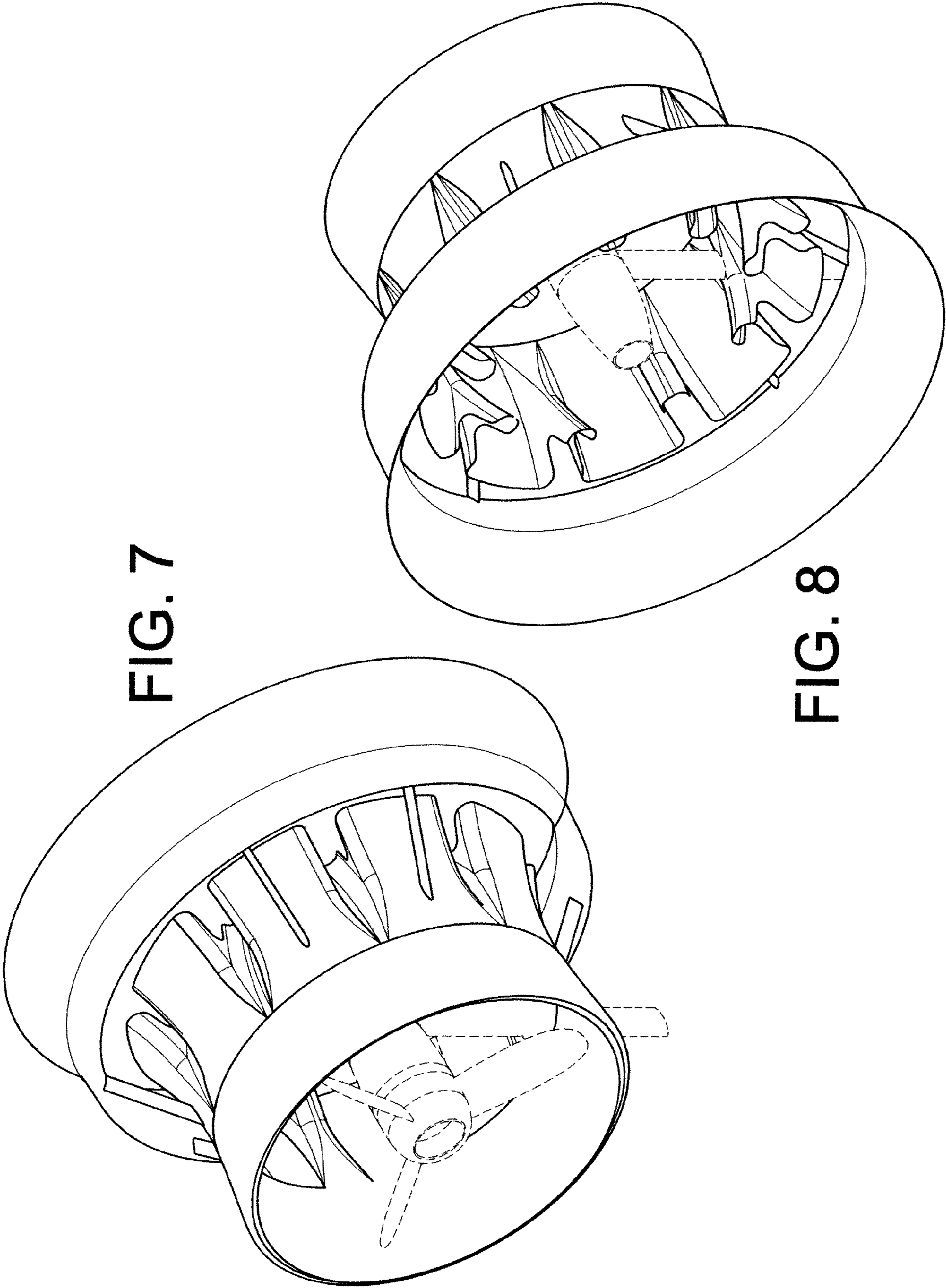

FIG. 7

FIG. 8