



US00D640937S

(12) **United States Design Patent**
Uedelhoven

(10) **Patent No.:** **US D640,937 S**

(45) **Date of Patent:** **** *Jul. 5, 2011**

(54) **WATCH**

(75) Inventor: **Jürgen Uedelhoven**, Gaimersheim (DE)

(73) Assignee: **Armatix Invest GmbH**, Zurich (CH)

(*) Notice: This patent is subject to a terminal disclaimer.

(**) Term: **14 Years**

(21) Appl. No.: **29/351,259**

(22) Filed: **Dec. 2, 2009**

(51) **LOC (9) Cl.** **10-02**

(52) **U.S. Cl.** **D10/38**

(58) **Field of Classification Search** D10/30–39;
368/276, 281, 282, 285, 82–84, 223
See application file for complete search history.

(56) **References Cited**

U.S. PATENT DOCUMENTS

D151,301	S	*	10/1948	Tuffo	D10/31
3,735,585	A	*	5/1973	Takagi	368/281
4,281,406	A	*	7/1981	Tanaka	368/82
D261,112	S	*	10/1981	Fukumura	D10/38
D261,113	S	*	10/1981	Fukumura	D10/39
D263,687	S	*	4/1982	Fukumura	D10/39
4,398,834	A	*	8/1983	Wakai	368/223
4,479,722	A	*	10/1984	Salah	368/17
D355,614	S	*	2/1995	Sato	D10/39
D356,043	S	*	3/1995	Iwamoto	D10/39
D401,159	S	*	11/1998	Sugita et al.	D10/30
D404,316	S	*	1/1999	Azegami et al.	D10/30
D407,027	S	*	3/1999	Kubo et al.	D10/30
D420,293	S	*	2/2000	Parmigiani	D10/30
D452,170	S	*	12/2001	Tomimatsu	D10/30
D474,117	S	*	5/2003	Dubois	D10/30
D474,699	S	*	5/2003	Hysek	D10/30
D489,272	S	*	5/2004	Messmer	D10/38
D491,820	S	*	6/2004	Bitetto	D10/39
D506,684	S	*	6/2005	Junod	D10/30

D527,657	S	*	9/2006	Wilcox et al.	D10/38
D554,541	S	*	11/2007	Gruosi	D10/38
D609,585	S	*	2/2010	d'Origny	D10/38

* cited by examiner

Primary Examiner — Lucy Lieberman

(74) *Attorney, Agent, or Firm* — Miller, Matthias & Hull LLP

(57) **CLAIM**

The ornamental design for a “watch,” as shown and described.

DESCRIPTION

FIG. 1 is a rear-right side top perspective view of a watch showing my new design;
 FIG. 2 is a front-right side top perspective view of the watch of FIG. 1;
 FIG. 3 is a rear-left side top perspective view of the watch of FIG. 1;
 FIG. 4 is a front-left side top perspective view of the watch of FIG. 1;
 FIG. 5 is a rear-right side bottom perspective view of the watch of FIG. 1;
 FIG. 6 is a front-right side bottom perspective view of the watch of FIG. 1;
 FIG. 7 is a rear-left side bottom perspective view of the watch of FIG. 1;
 FIG. 8 is a front-left side bottom perspective view of the watch of FIG. 1;
 FIG. 9 is a top view of the watch of FIG. 1;
 FIG. 10 is a bottom view of the watch of FIG. 1;
 FIG. 11 is a front view of the watch of FIG. 1;
 FIG. 12 is a rear view of the watch of FIG. 1;
 FIG. 13 is a right side view of the watch of FIG. 1; and,
 FIG. 14 is a left side view of the watch of FIG. 1.

1 Claim, 7 Drawing Sheets

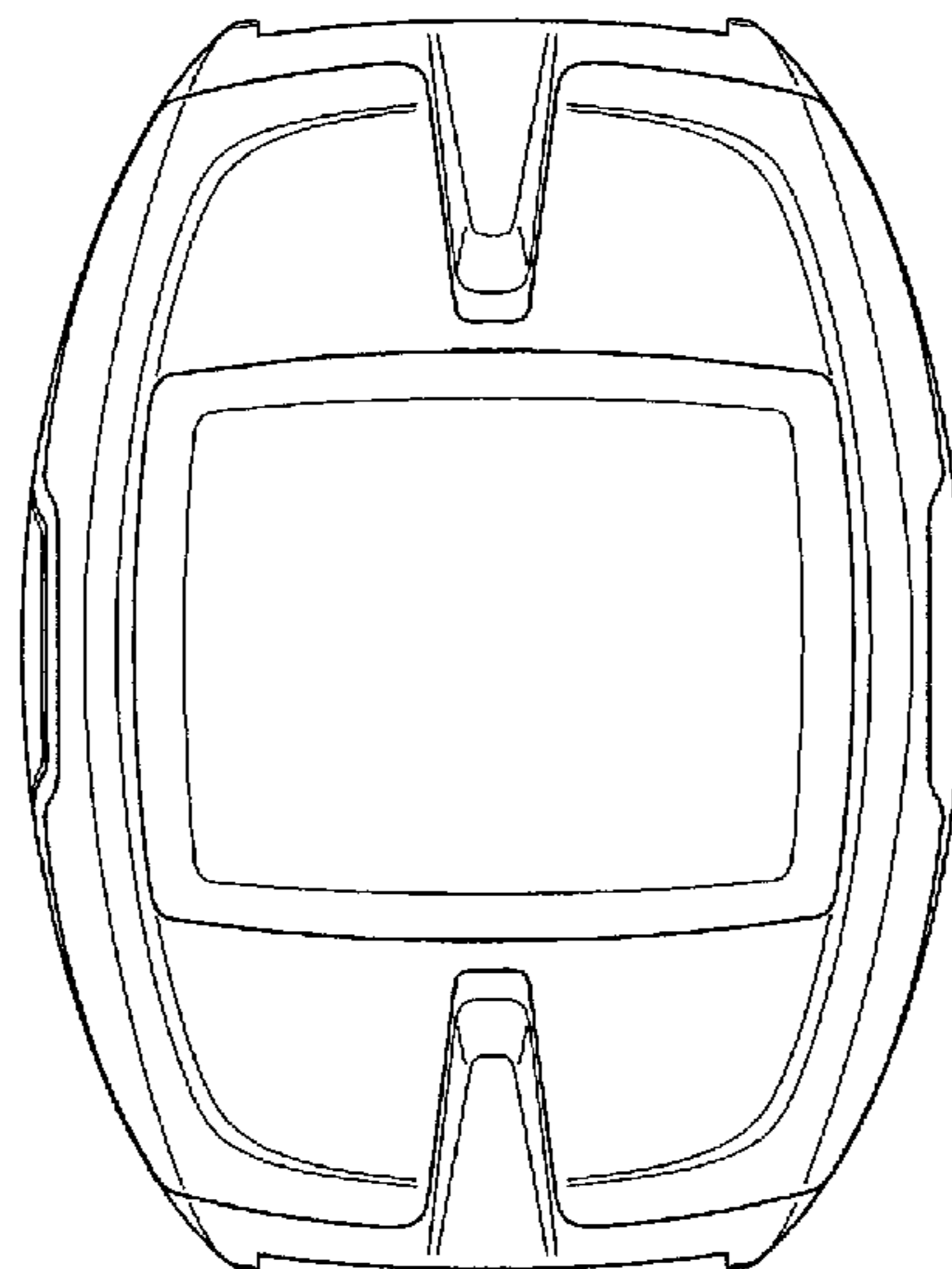

FIG. 1

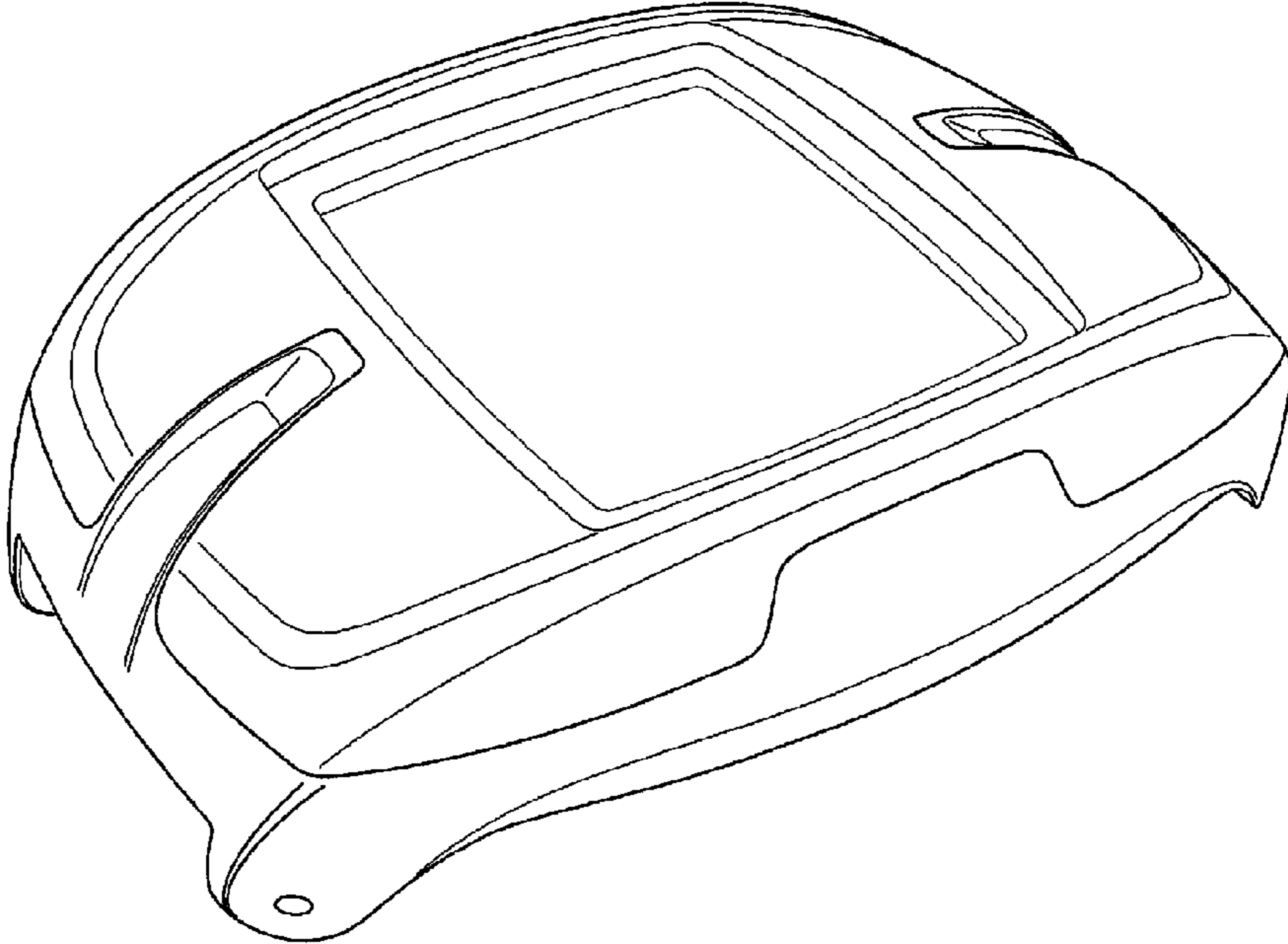

FIG. 2

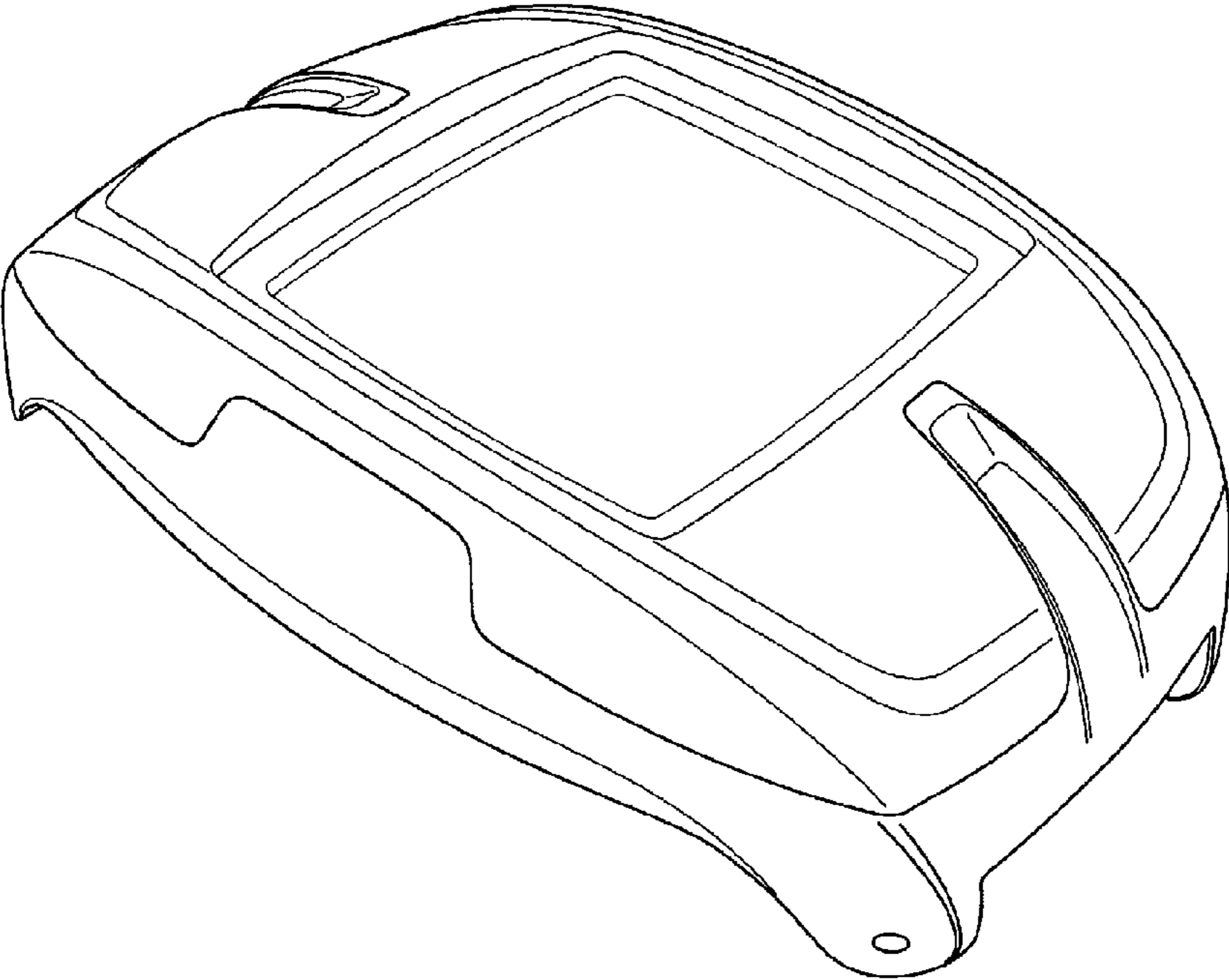

FIG. 3

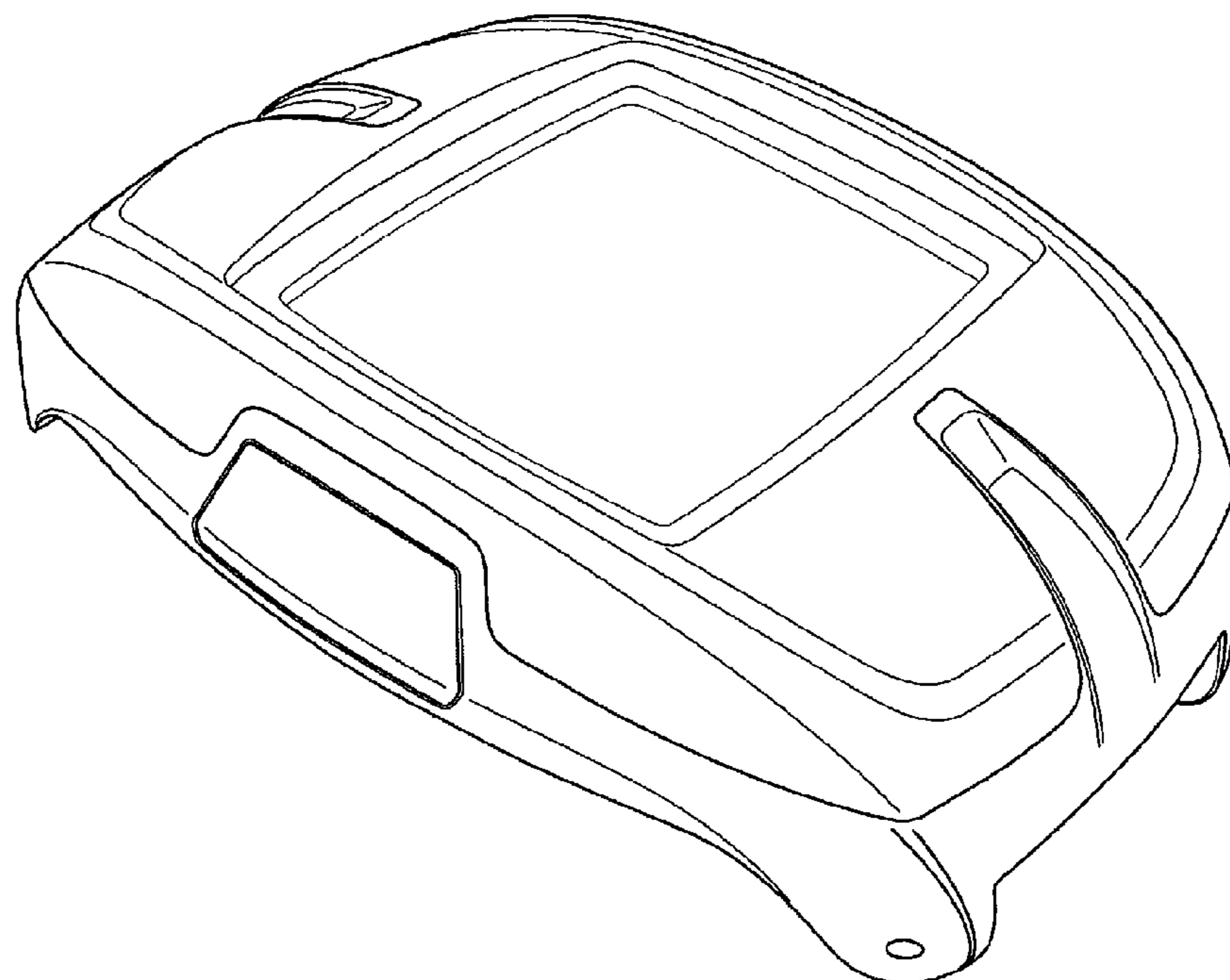
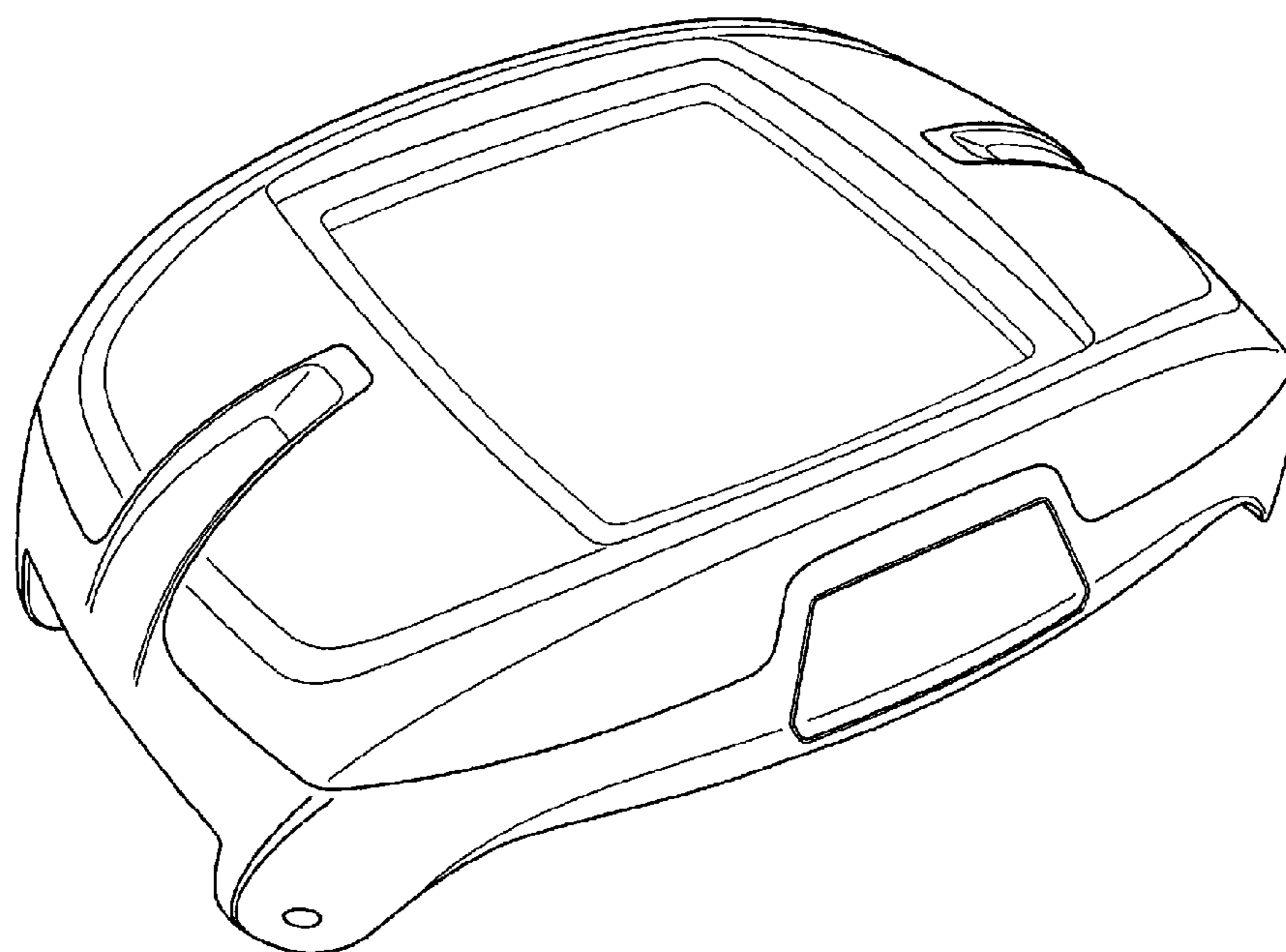

FIG. 4



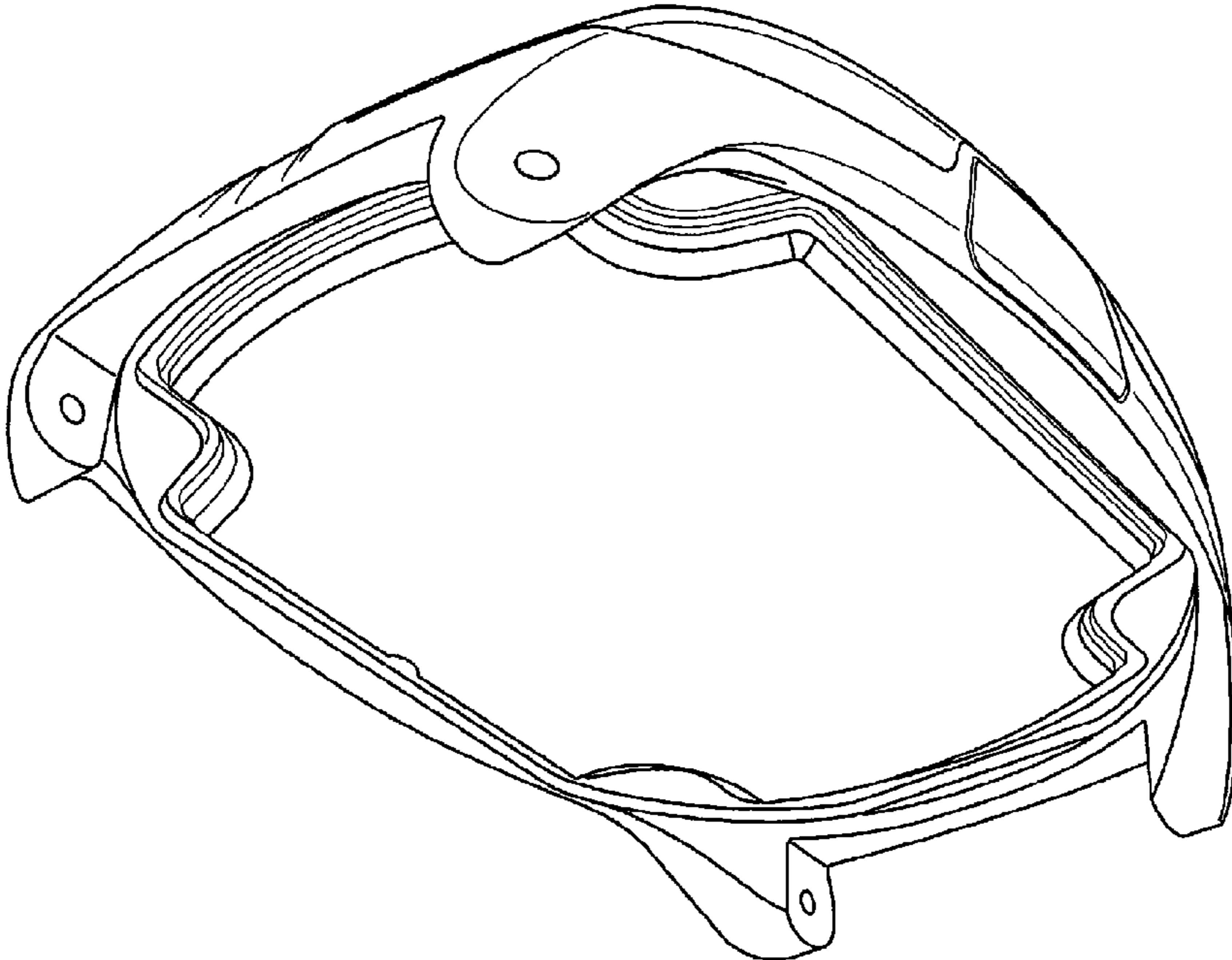

FIG. 5

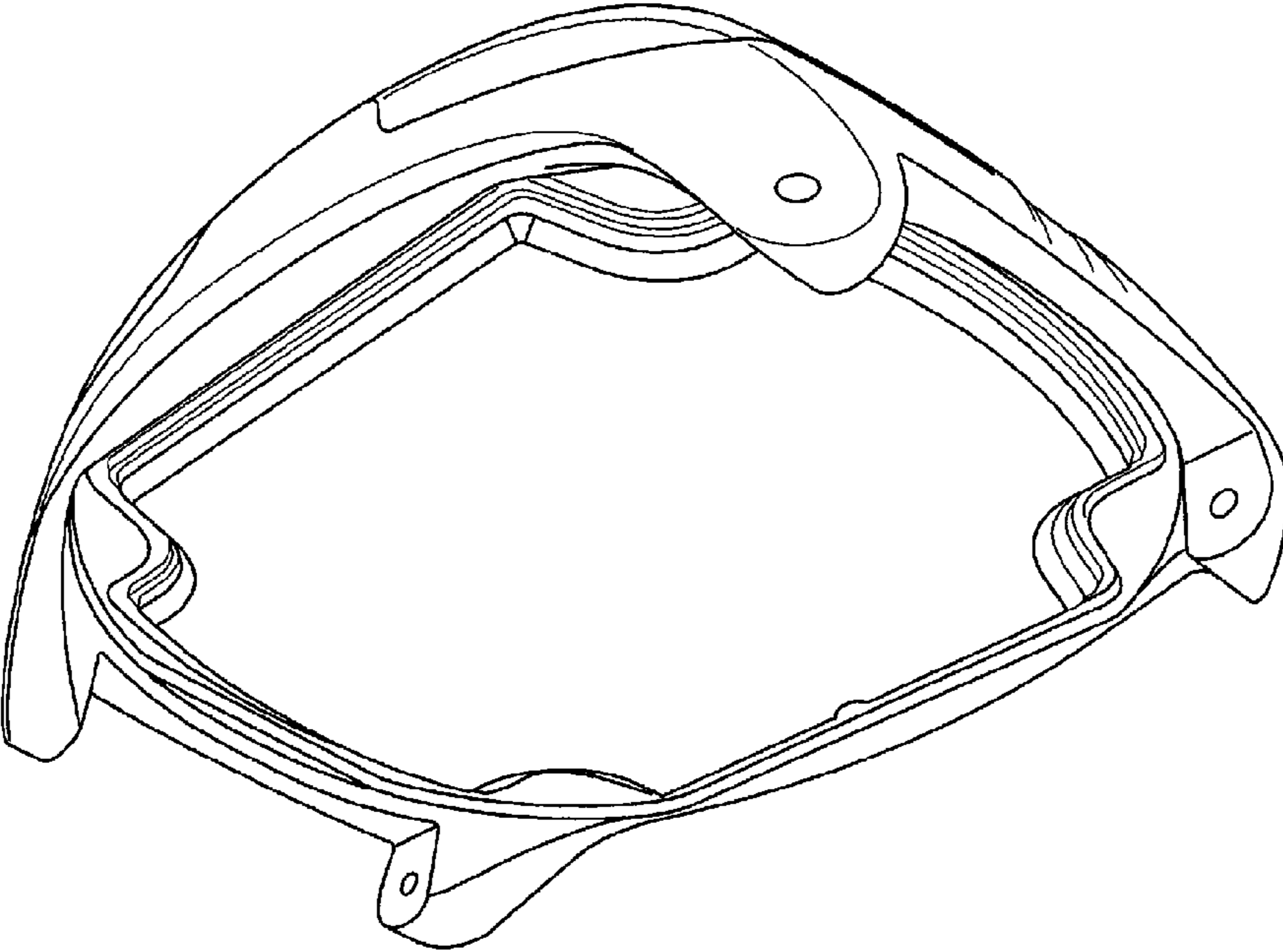

FIG. 6

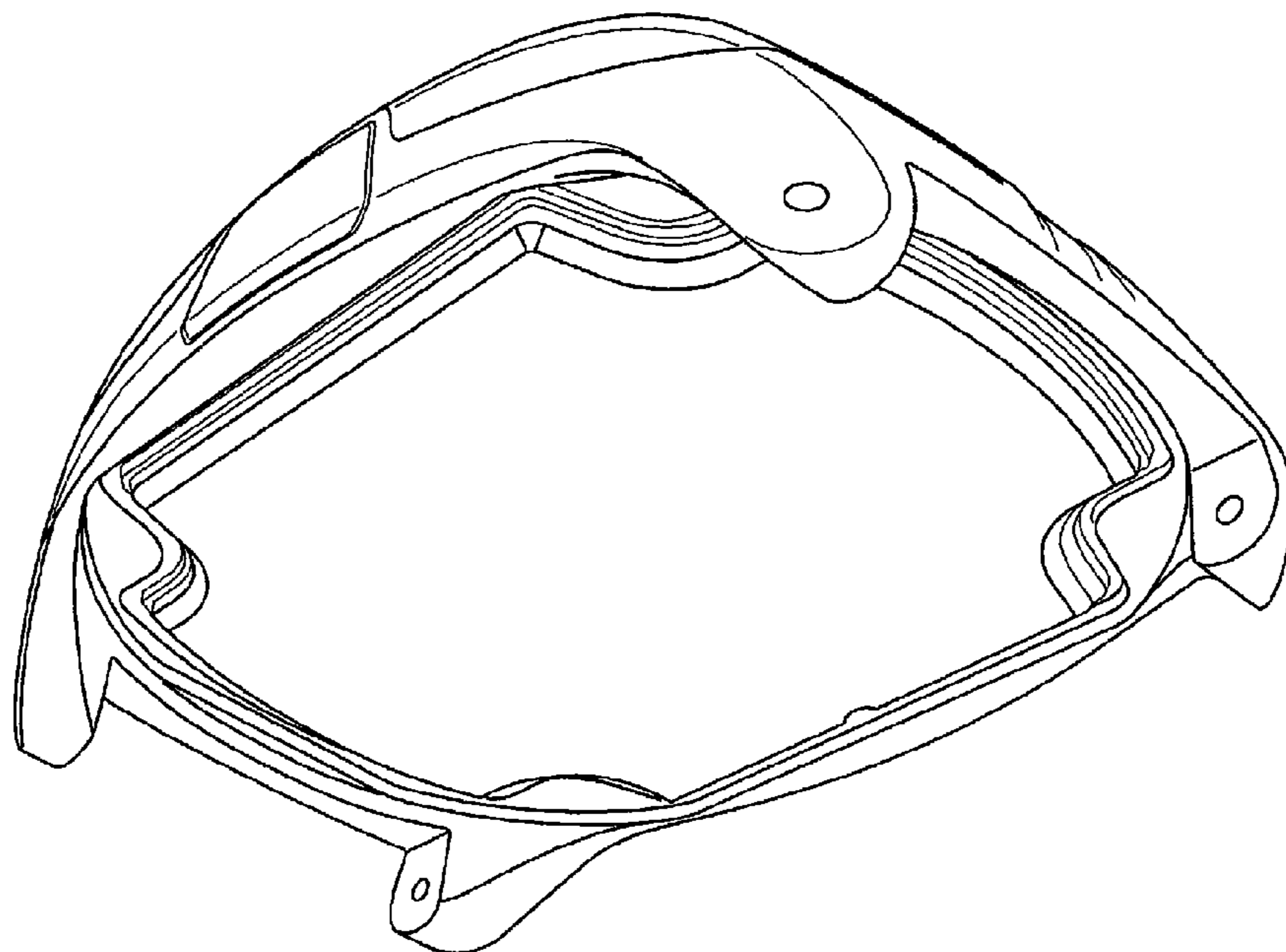

FIG. 7

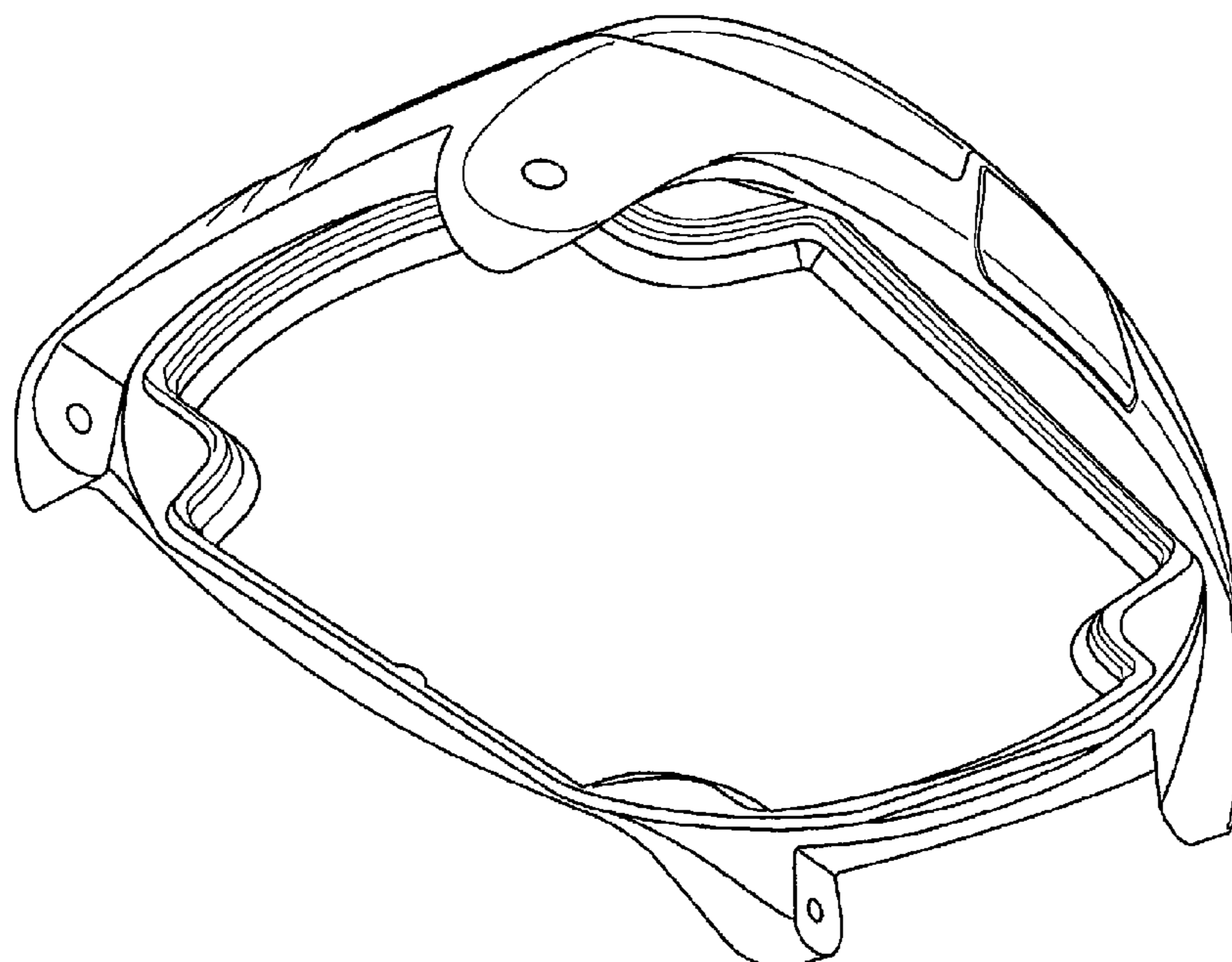

FIG. 8

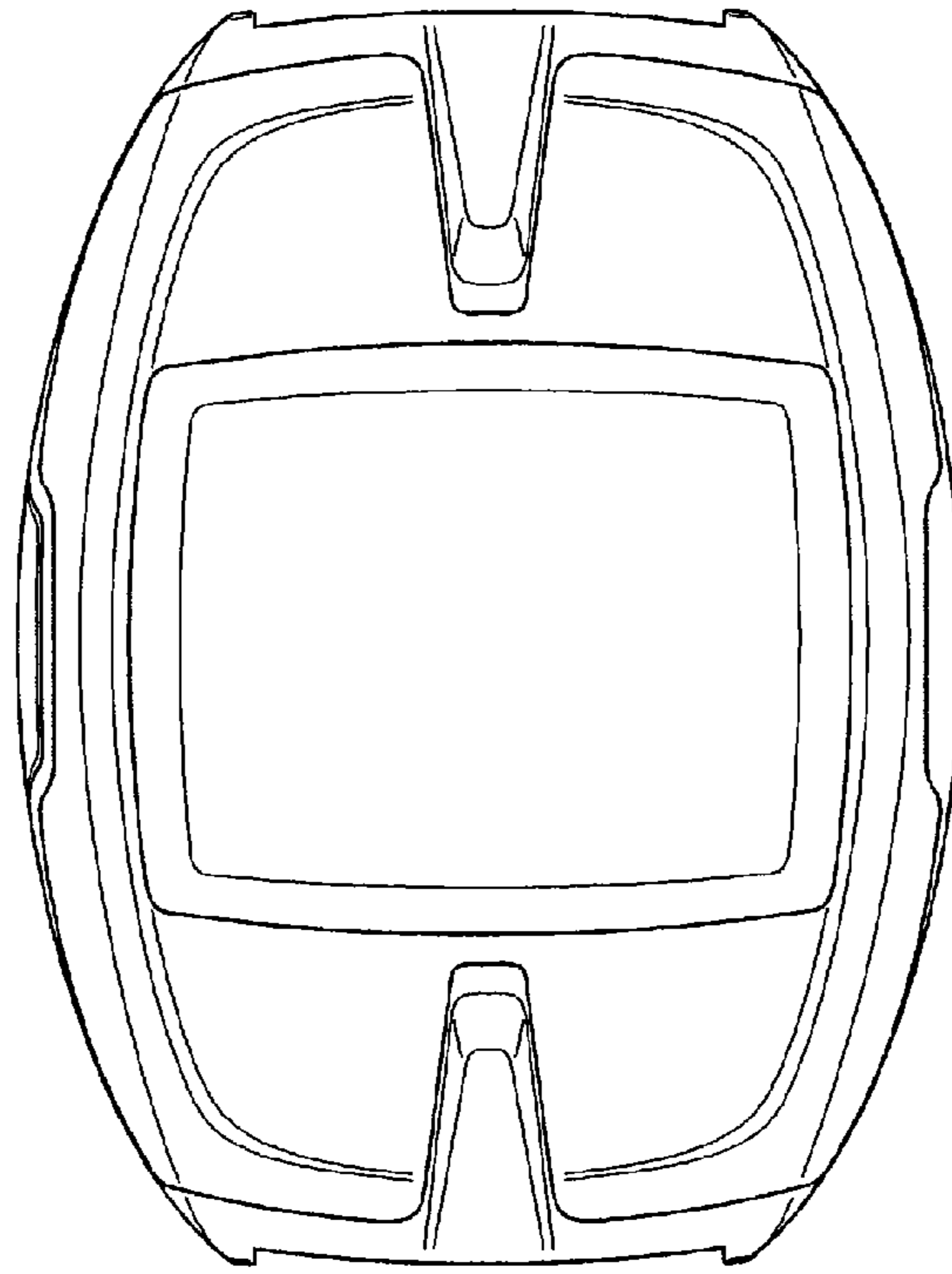

FIG. 9

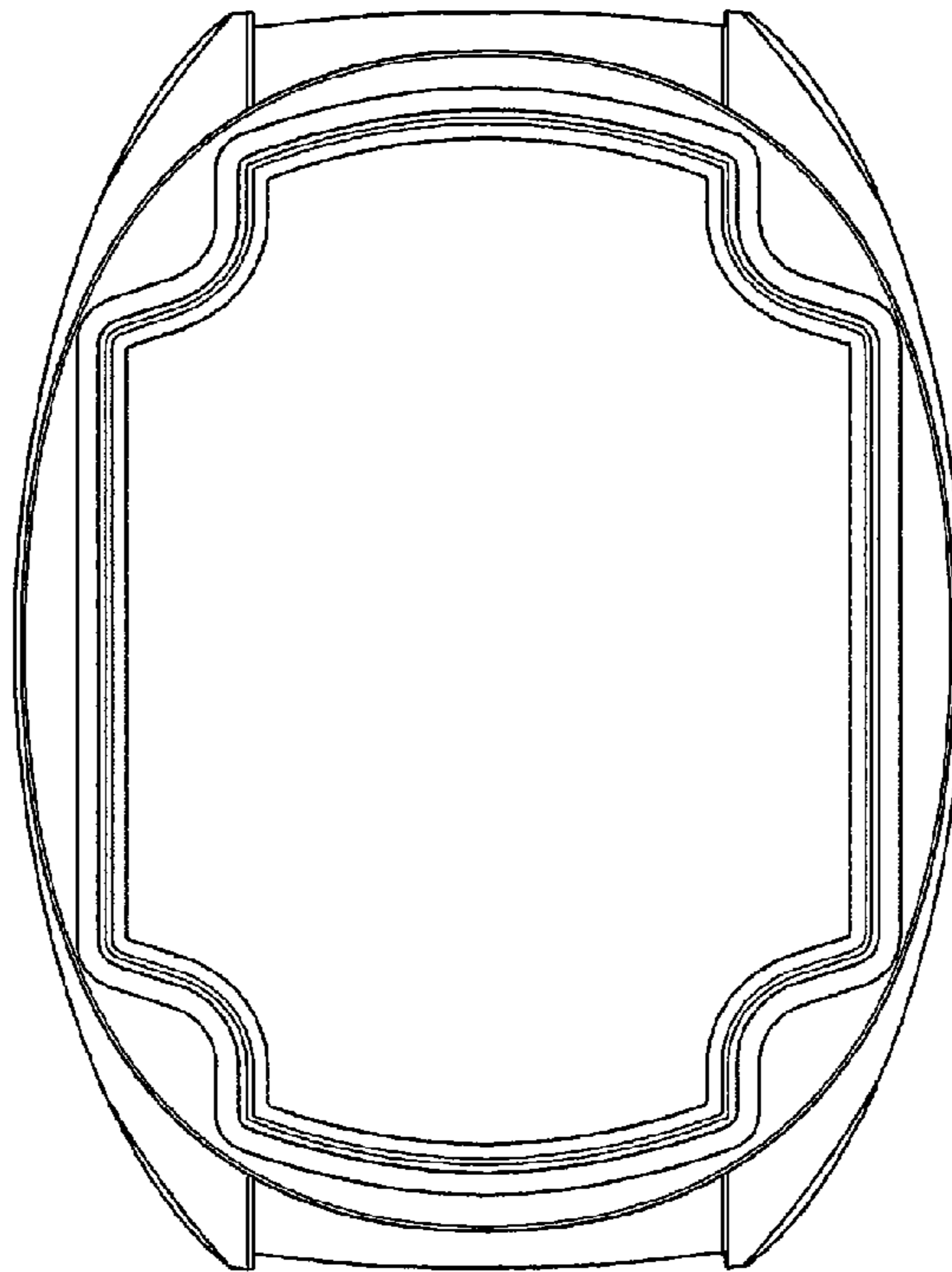

FIG. 10

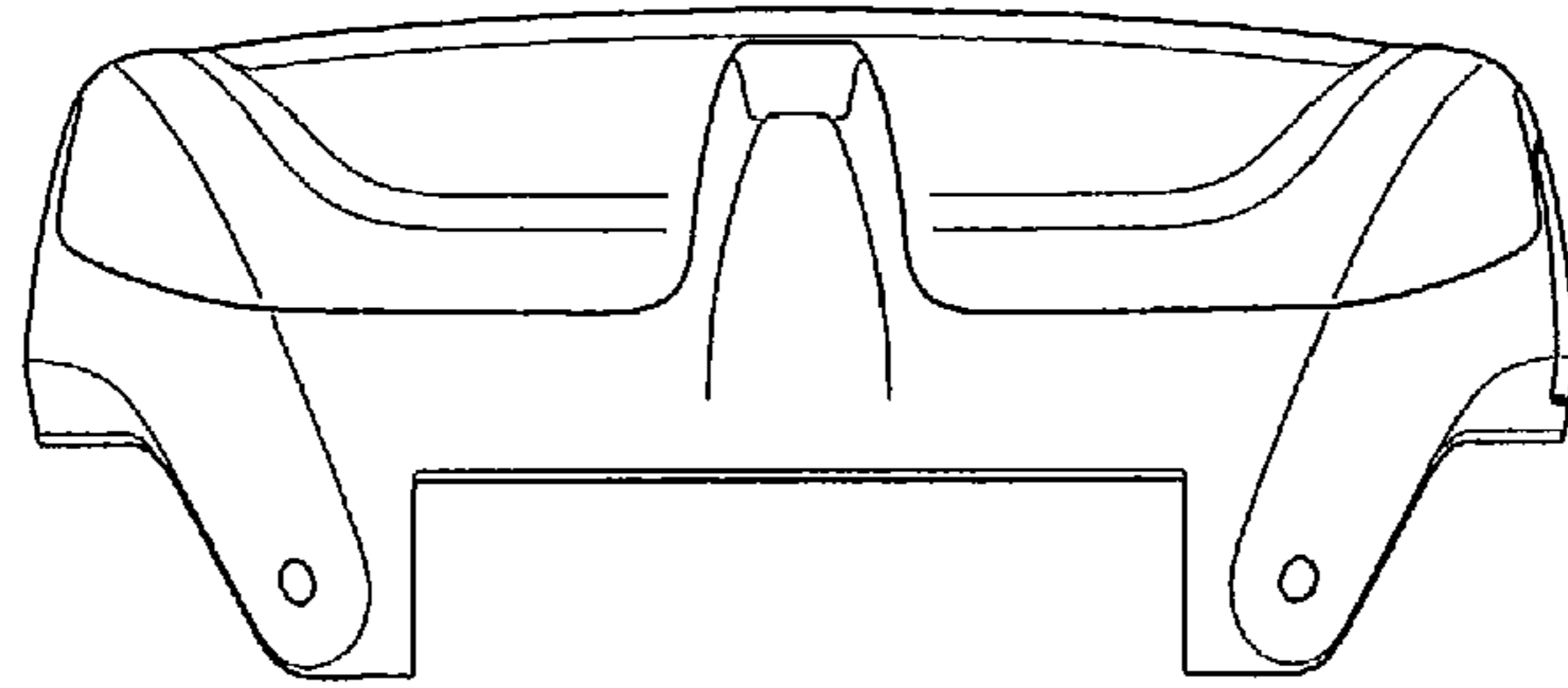

FIG. 11

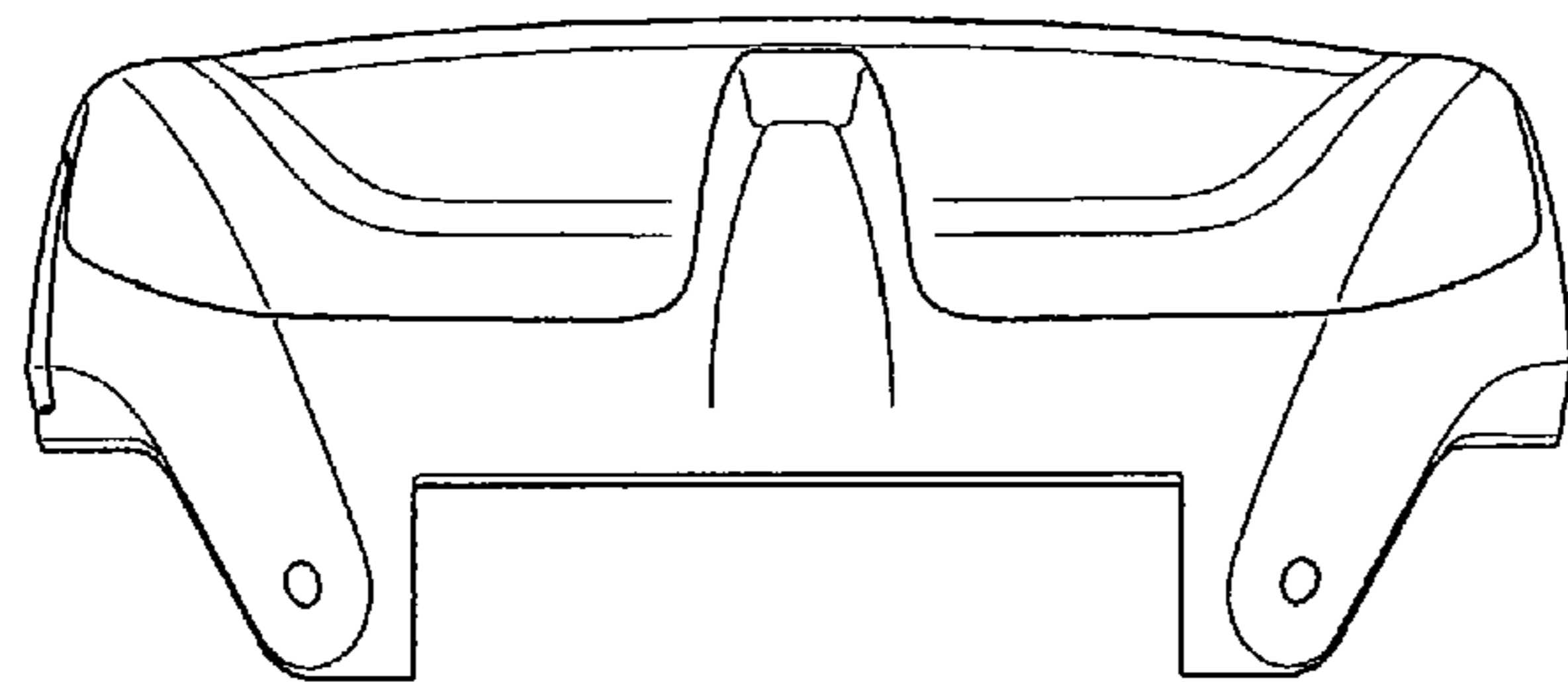

FIG. 12

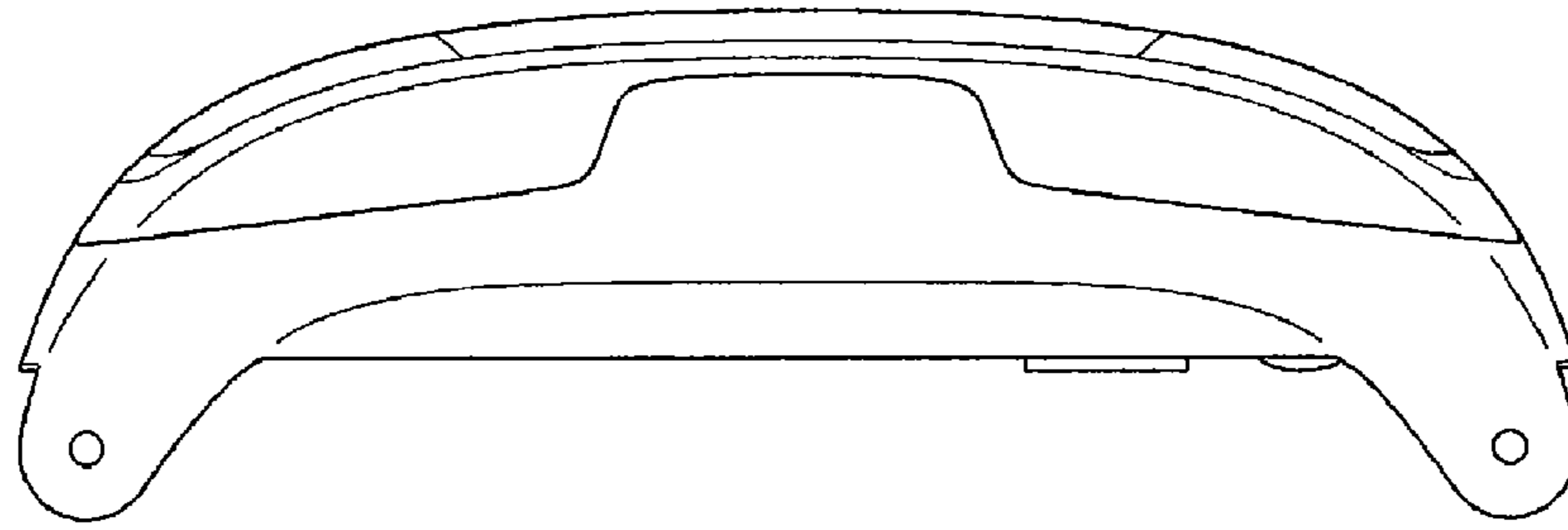

FIG. 13

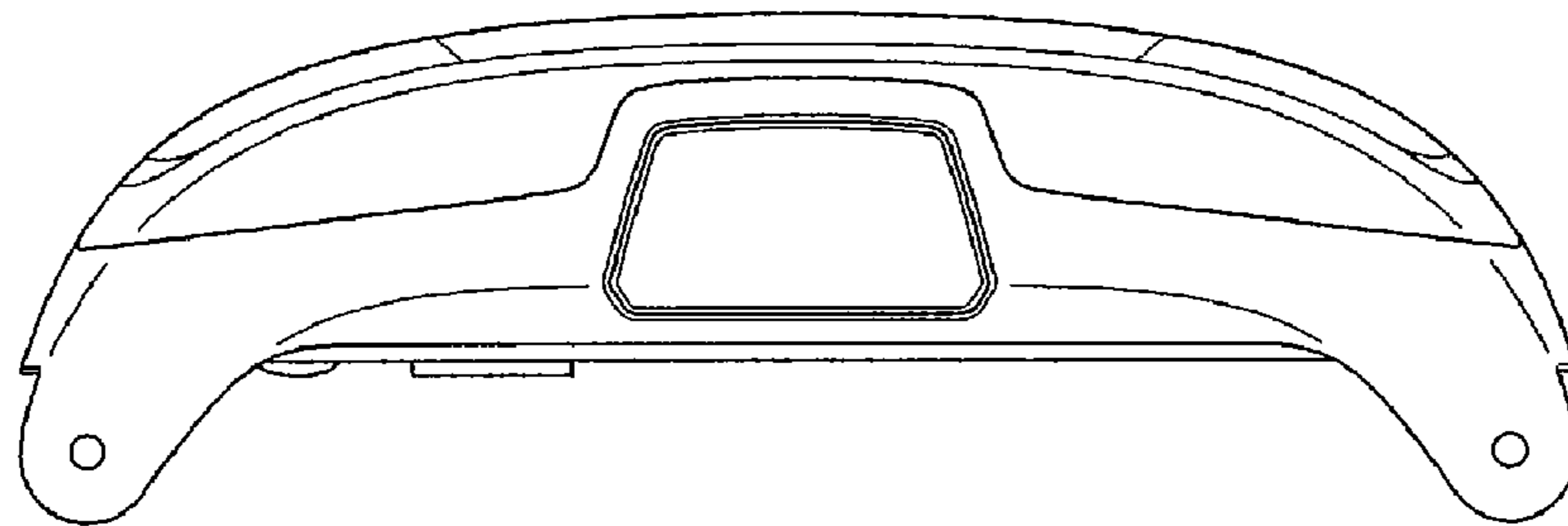

FIG. 14