



US00D640854S

(12) **United States Design Patent**
Leum

(10) **Patent No.:** **US D640,854 S**

(45) **Date of Patent:** **** Jun. 28, 2011**

(54) **HINGED DOCK RAMP**

(76) Inventor: **Grant Leum**, Excelsior, MN (US)

(**) Term: **14 Years**

(21) Appl. No.: **29/368,170**

(22) Filed: **Aug. 19, 2010**

(51) **LOC (9) Cl.** **12-05**

(52) **U.S. Cl.** **D34/32**

(58) **Field of Classification Search** D34/32,
D34/28; 414/537; 14/71.1, 71.7, 69.5, 71.3,
14/304.1; 16/386

See application file for complete search history.

2008/0184500 A1* 8/2008 Bettcher 14/71.1
2010/0032918 A1* 2/2010 Chamoun 280/30
2010/0242189 A1* 9/2010 Goin et al. 14/71.1

OTHER PUBLICATIONS

Definition from answers.com.

* cited by examiner

Primary Examiner — Cynthia Ramirez

(74) *Attorney, Agent, or Firm* — Jansson Shupe & Munger Ltd.

(57) **CLAIM**

The ornamental design for a hinged dock ramp, as shown and described.

DESCRIPTION

FIG. 1 is a perspective view of a hinged dock ramp;
FIG. 2 is a side view of the hinged dock ramp of FIG. 1;
FIG. 3 is another side view of the hinged dock ramp of FIG. 1;
FIG. 4 is a front view of the hinged dock ramp of FIG. 1;
FIG. 5 is a back view of the hinged dock ramp of FIG. 1; and,
FIG. 6 is a top view of the hinged dock ramp of FIG. 1.
The dashed lines are provided for illustrative purposes only and form no part of the claimed design.

1 Claim, 4 Drawing Sheets

(56) **References Cited**

U.S. PATENT DOCUMENTS

1,819,450	A	8/1931	Weller	
4,348,780	A	9/1982	Angelo et al.	
4,624,446	A	11/1986	Gould	
4,765,792	A	8/1988	Cherry et al.	
D300,073	S *	2/1989	Crump	D34/32
4,972,539	A	11/1990	Reiter	
5,106,246	A	4/1992	Chance	
D358,924	S	5/1995	Achenbach	
6,368,043	B1	4/2002	Leum et al.	
7,062,814	B2	6/2006	Bender et al.	
D617,972	S *	6/2010	Lucht	D34/32

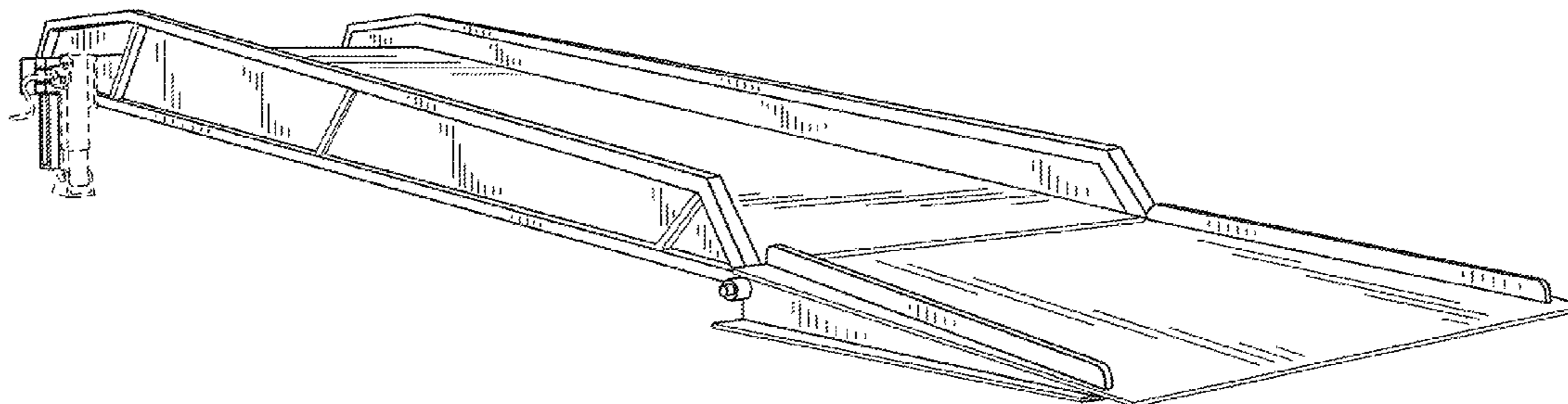

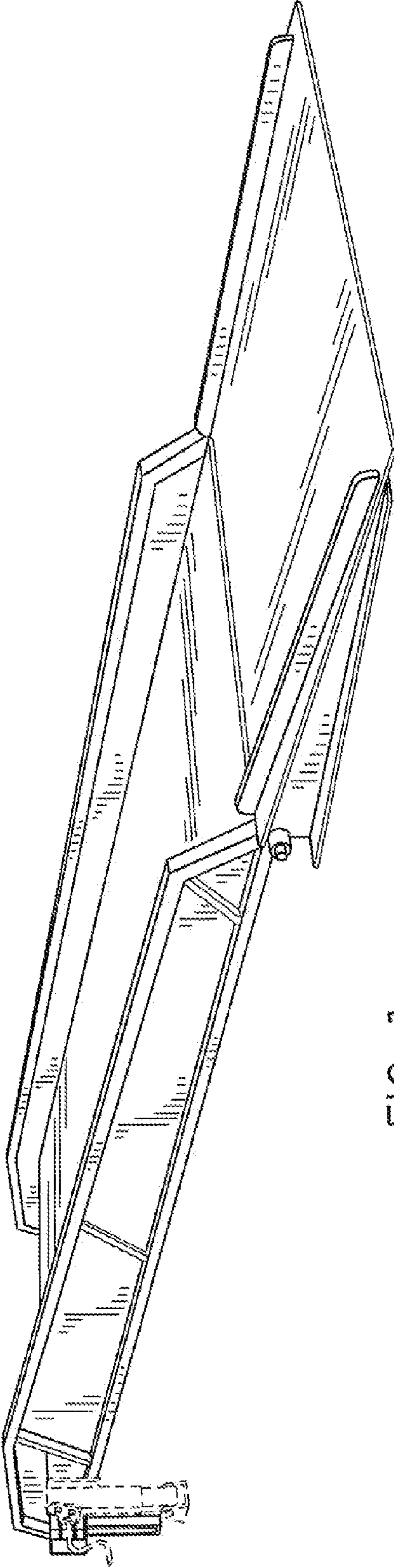

FIG. 1

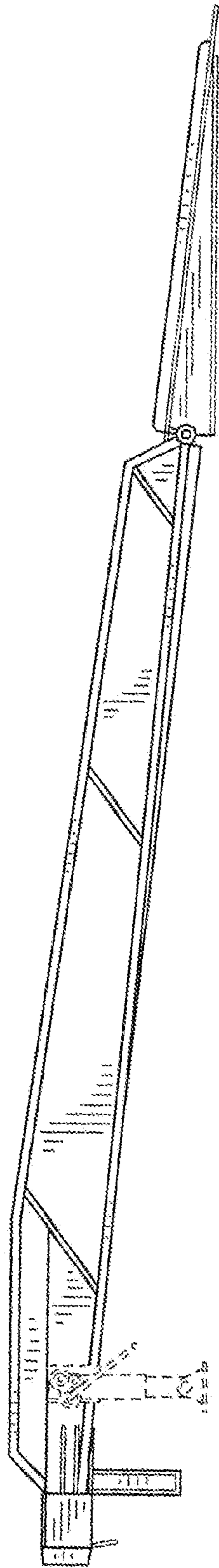

FIG. 2

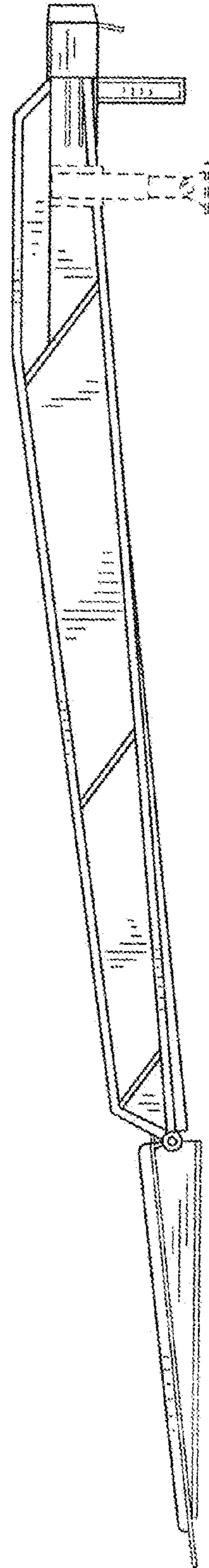

FIG. 3

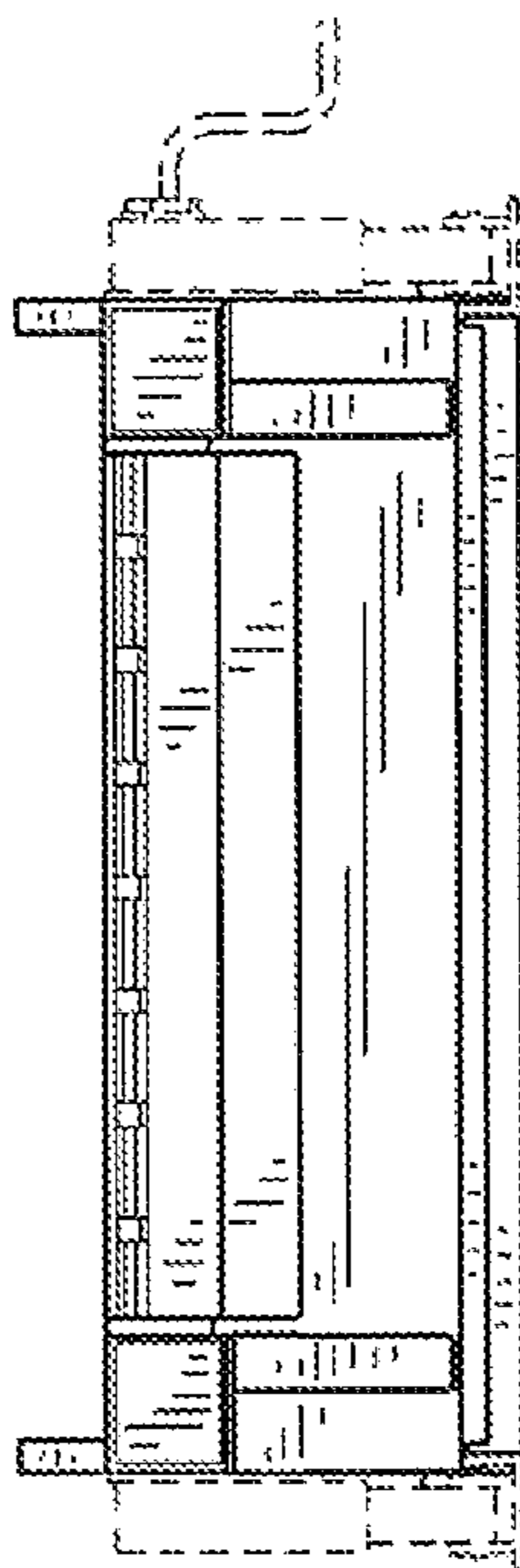

FIG. 5

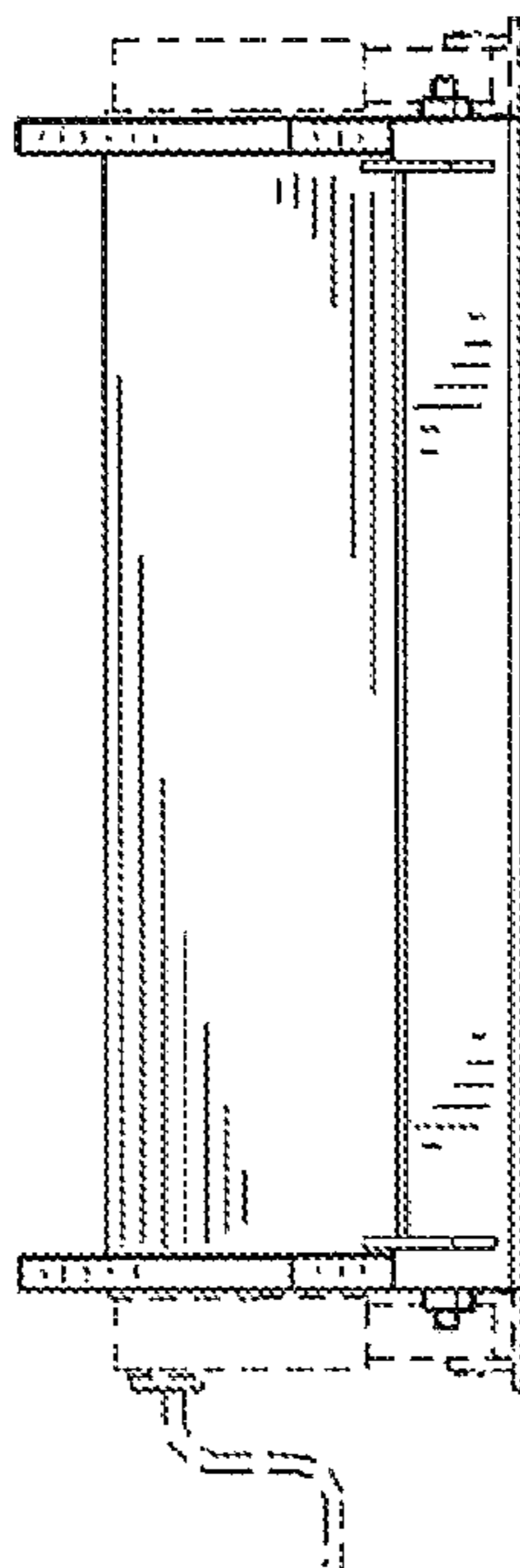

FIG. 4

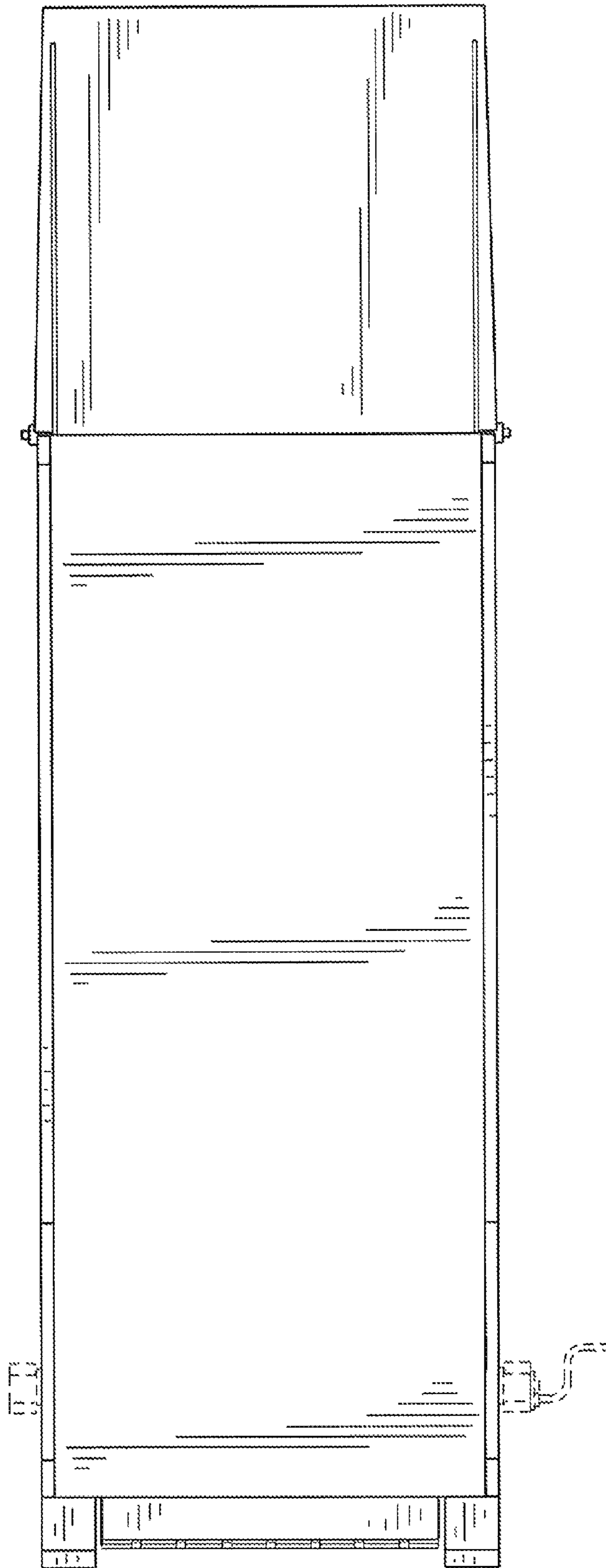

FIG. 6