



US00D640784S

(12) **United States Design Patent**
Niland et al.

(10) **Patent No.:** **US D640,784 S**
(45) **Date of Patent:** **** Jun. 28, 2011**

(54) **HYPERTHERMIC HUMIDIFICATION SYSTEM**

(75) Inventors: **William F. Niland**, Arnold, MD (US);
Owen S. Bamford, Linthicum, MD (US);
Felino V. Cortez, Jr., Bowie, MD (US);
George McGarrity, Denton, MD (US);
David Wheeler, Portsmouth, RI (US);
Luke Hagan, Barrington, RI (US)

(73) Assignee: **Vapotherm, Inc.**, Stevensville, MD (US)

(**) Term: **14 Years**

(21) Appl. No.: **29/292,306**

(22) Filed: **Oct. 5, 2007**

(51) **LOC (9) Cl.** **29-02**

(52) **U.S. Cl.** **D24/110**

(58) **Field of Classification Search** D24/110-110.6;
D16/339; 128/207.17, 207.11, 848; 2/171.2,
2/171.8

See application file for complete search history.

(56) **References Cited**

U.S. PATENT DOCUMENTS

4,013,742	A	3/1977	Lang	
4,060,576	A	11/1977	Grant	
4,110,419	A	8/1978	Miller	
4,323,064	A	4/1982	Hoenig et al.	
4,354,984	A	10/1982	Richardson et al.	
4,589,409	A	5/1986	Chatburn et al.	
4,621,632	A	11/1986	Bartels et al.	
4,621,633	A	11/1986	Bowles et al.	
4,682,010	A	7/1987	Drapeau et al.	
4,715,998	A	12/1987	Clow	
4,832,012	A	5/1989	Raabe et al.	
4,844,072	A	7/1989	French et al.	
4,921,642	A	5/1990	LaTorraca	
5,038,840	A	8/1991	Fair	
5,454,368	A	10/1995	Tarulli	
5,549,720	A	8/1996	Miller et al.	
5,590,648	A	1/1997	Mitchell et al.	
D421,298	S	2/2000	Kenyon et al.	
D457,453	S *	5/2002	Ogawa D10/97
6,523,810	B2	2/2003	Offir et al.	

6,536,430	B1	3/2003	Smith
6,554,260	B1	4/2003	Lipscombe et al.
6,560,408	B2	5/2003	Glucksman et al.
6,613,280	B2	9/2003	Myrick et al.
6,827,084	B2	12/2004	Grubb, Jr.

(Continued)

OTHER PUBLICATIONS

Vapotherm, the new standard in high flow therapy brochure, 6 pp., undated.

Primary Examiner — T. Chase Nelson

Assistant Examiner — Michael Pratt

(74) *Attorney, Agent, or Firm* — RatnerPrestia

(57) **CLAIM**

The ornamental design for a hyperthermic humidification system, as shown and described.

DESCRIPTION

FIG. 1 is a front perspective view of a hyperthermic humidification system according to an embodiment of the present invention;

FIG. 2 is another front perspective view of the hyperthermic humidification system shown in FIG. 1;

FIG. 3 is a front view of the hyperthermic humidification system shown in FIG. 1;

FIG. 4 is a left side view of the hyperthermic humidification system shown in FIG. 1; the handle on the top of the article being shown in an alternate position;

FIG. 5 is a right side view of the hyperthermic humidification system shown in FIG. 1;

FIG. 6 is a rear view of the hyperthermic humidification system shown in FIG. 1;

FIG. 7 is a top view of the hyperthermic humidification system shown in FIG. 1; and,

FIG. 8 is a bottom view of the hyperthermic humidification system shown in FIG. 1.

The broken line showing of portions of the hyperthermic humidification system in FIGS. 1 through 8 forms no part of the claimed design.

1 Claim, 8 Drawing Sheets

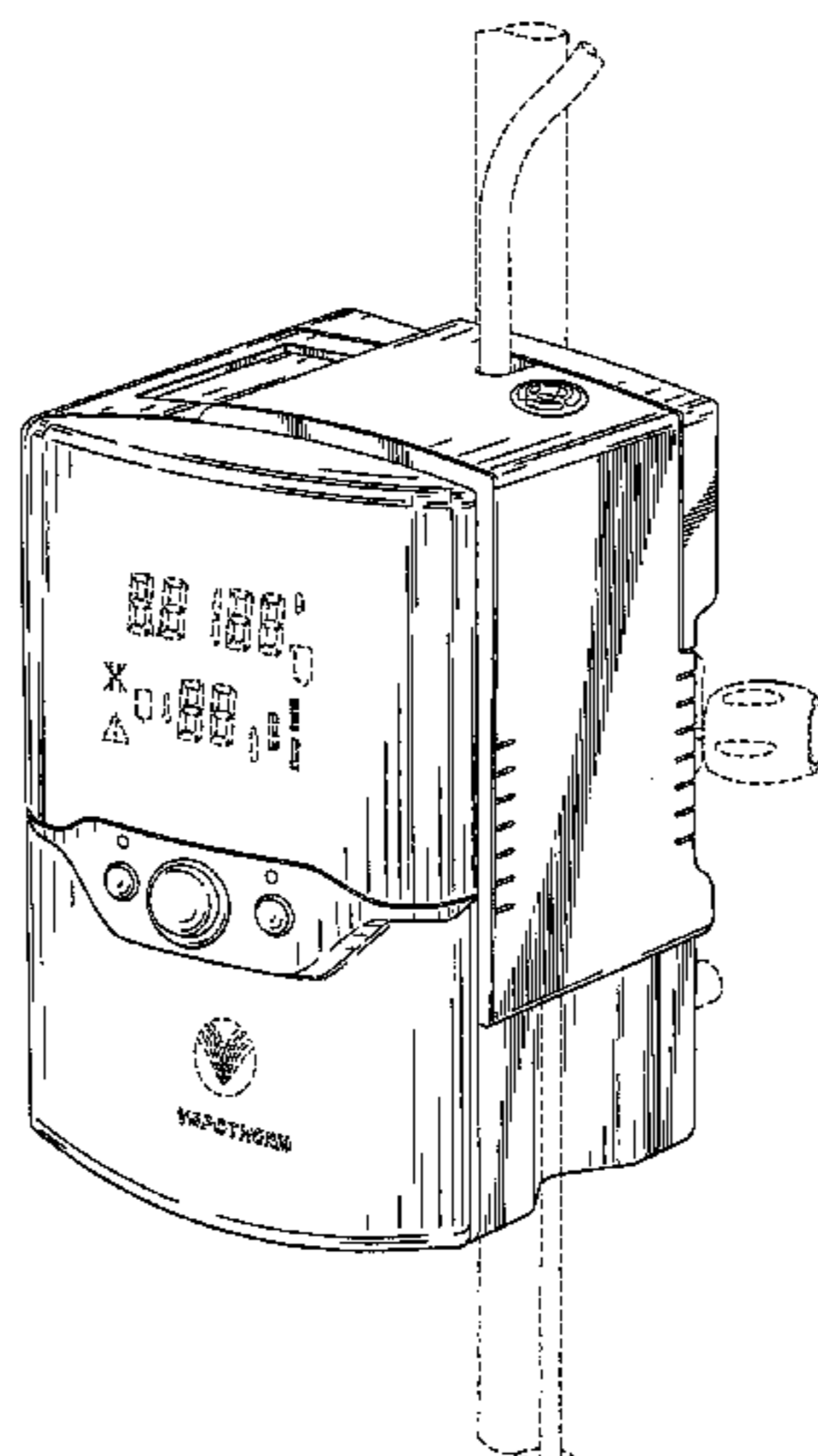

US D640,784 S

Page 2

U.S. PATENT DOCUMENTS			
D503,119	S *	3/2005	Motomizu et al. D10/92
6,938,886	B2	9/2005	Glucksman
6,988,497	B2	1/2006	Levine
6,997,185	B2	2/2006	Han et al.
7,066,452	B2	6/2006	Rotering et al.
7,111,624	B2	9/2006	Thudor et al.
7,137,388	B2	11/2006	Virr et al.
7,314,046	B2 *	1/2008	Schroeder et al. 128/200.14
2002/0136662	A1	9/2002	Myrick et al.
2002/0154903	A1	10/2002	Glucksman et al.
2003/0209246	A1 *	11/2003	Schroeder et al. 128/204.17
2003/0236015	A1	12/2003	Edirisuriya et al.
2004/0004299	A1	1/2004	Glucksman
2005/0133031	A1	6/2005	Han et al.
2006/0113690	A1	6/2006	Huddart et al.
2006/0118111	A1	6/2006	Pelerossi et al.
2006/0130836	A1	6/2006	Wixey et al.
2006/0191531	A1	8/2006	Mayer et al.
2006/0222347	A1	10/2006	Weffler
2008/0066755	A1 *	3/2008	Janbakhsh et al. 128/205.25

* cited by examiner

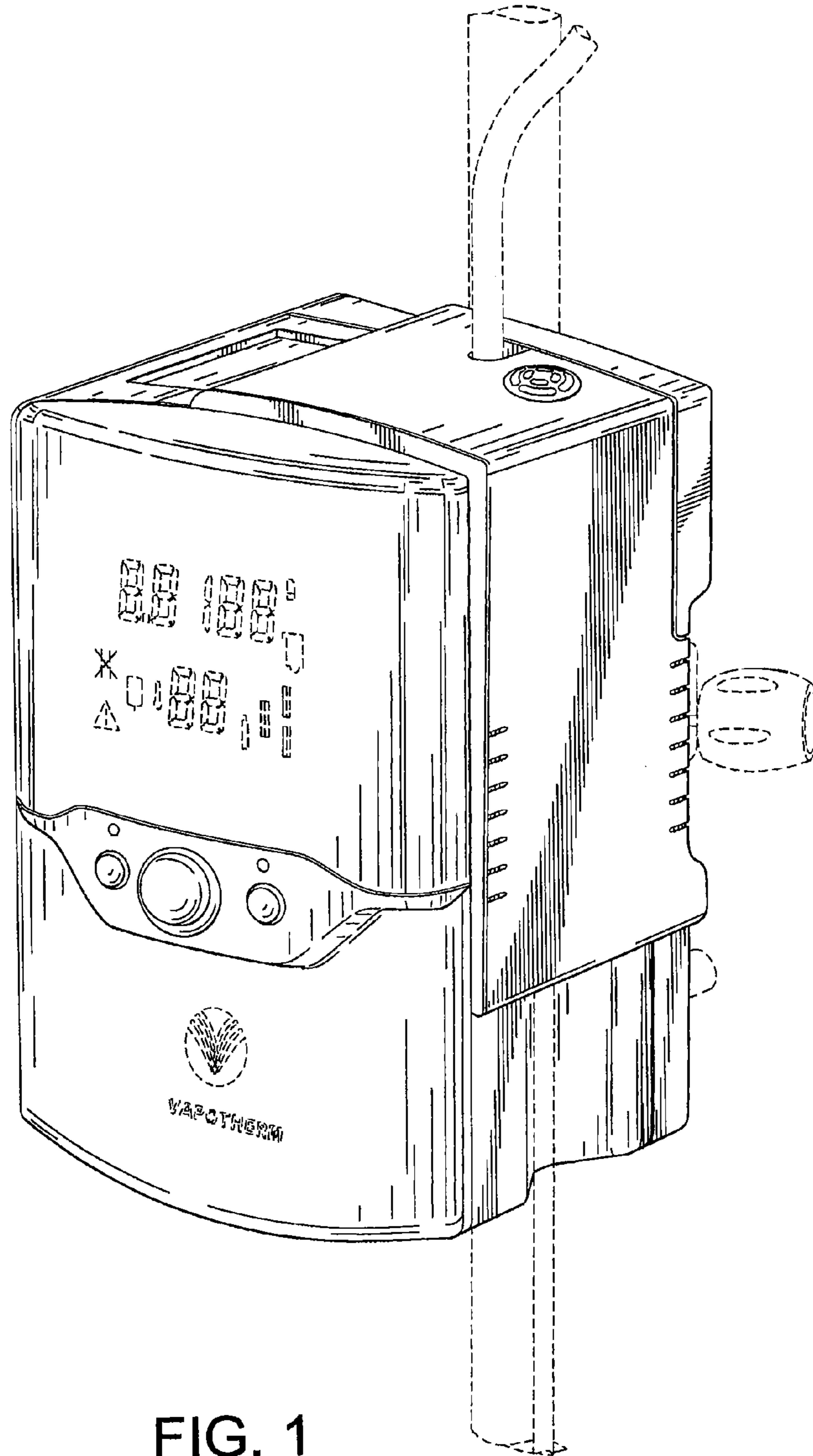

FIG. 1

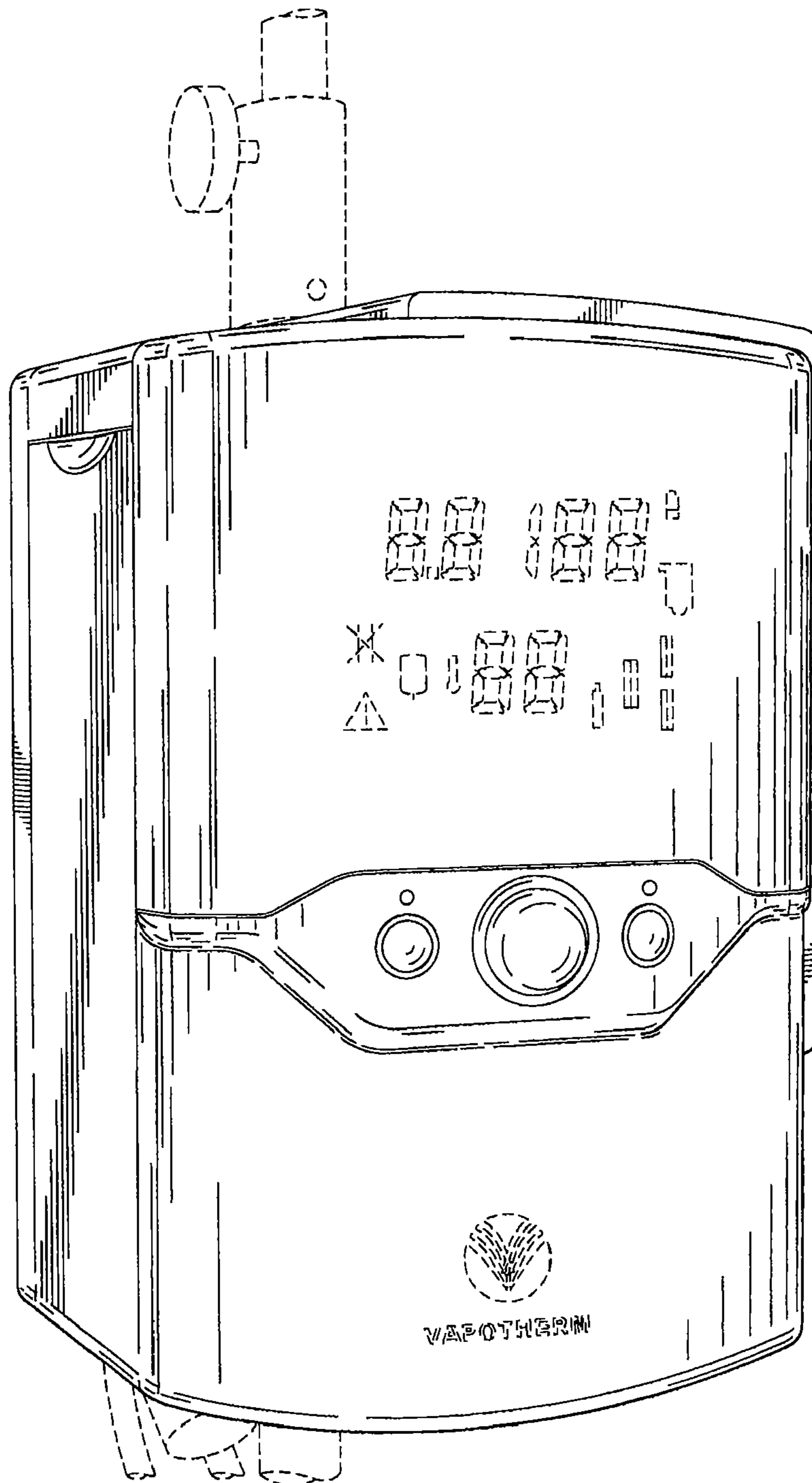

FIG. 2

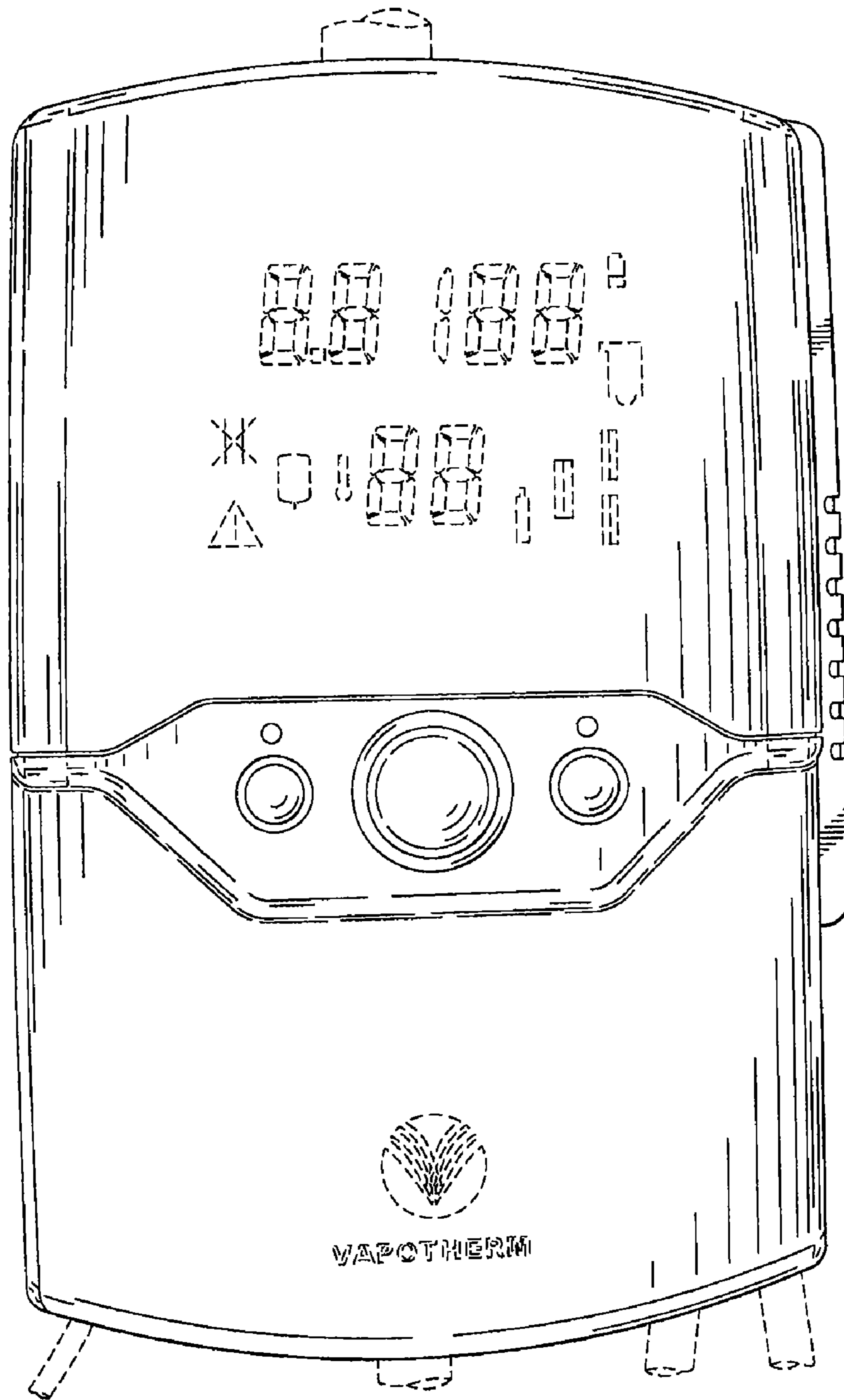

FIG. 3

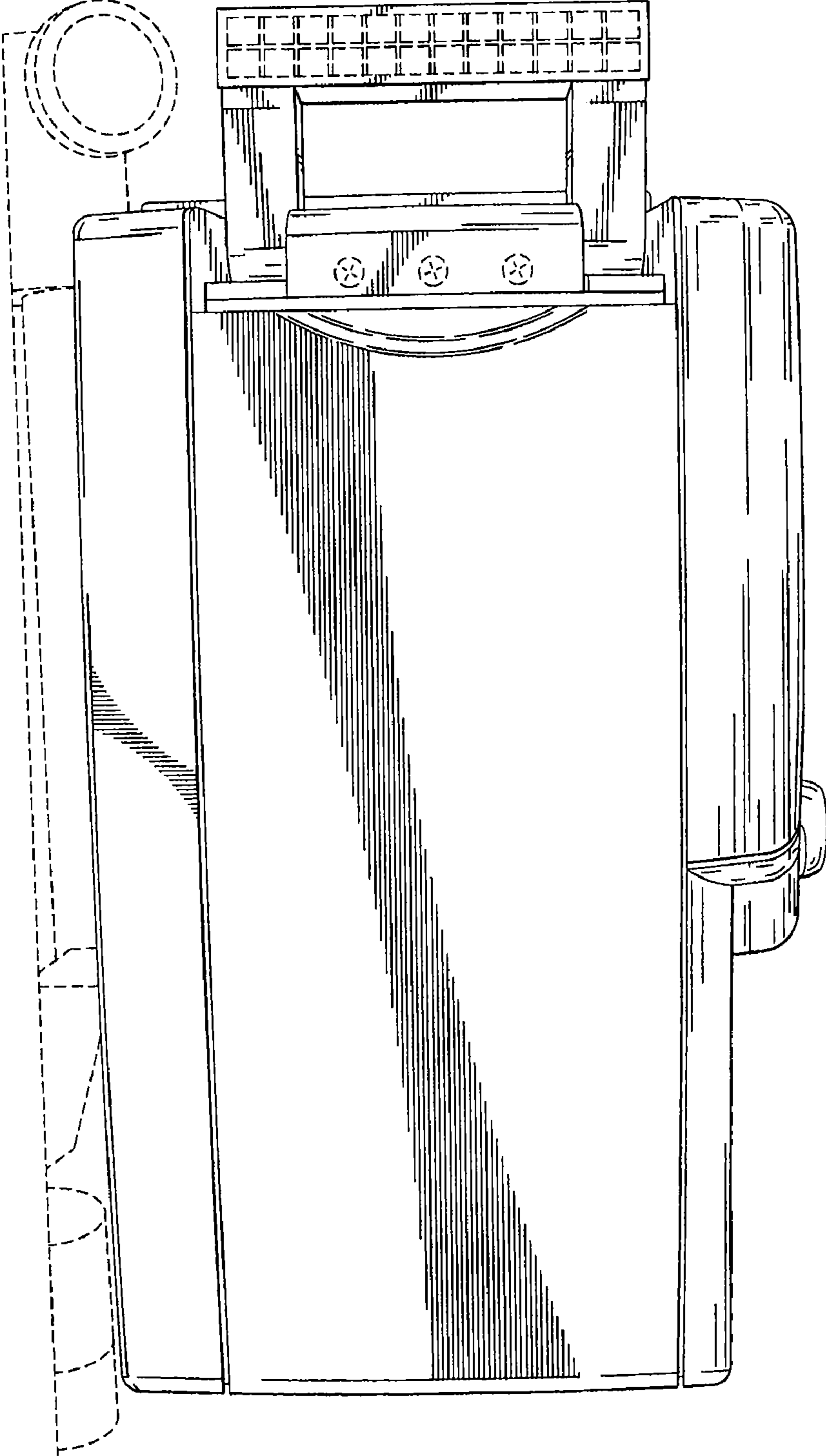

FIG. 4

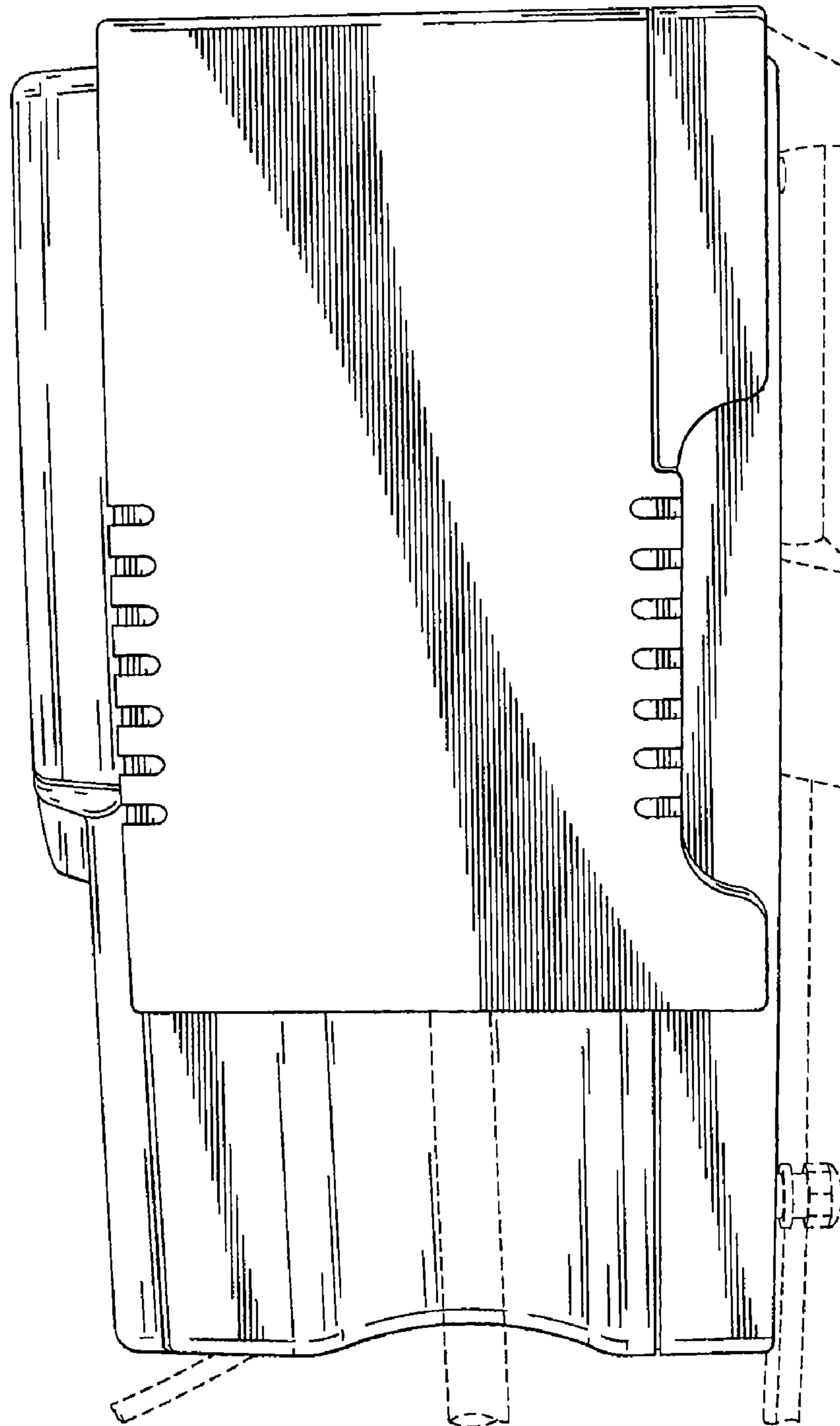

FIG. 5

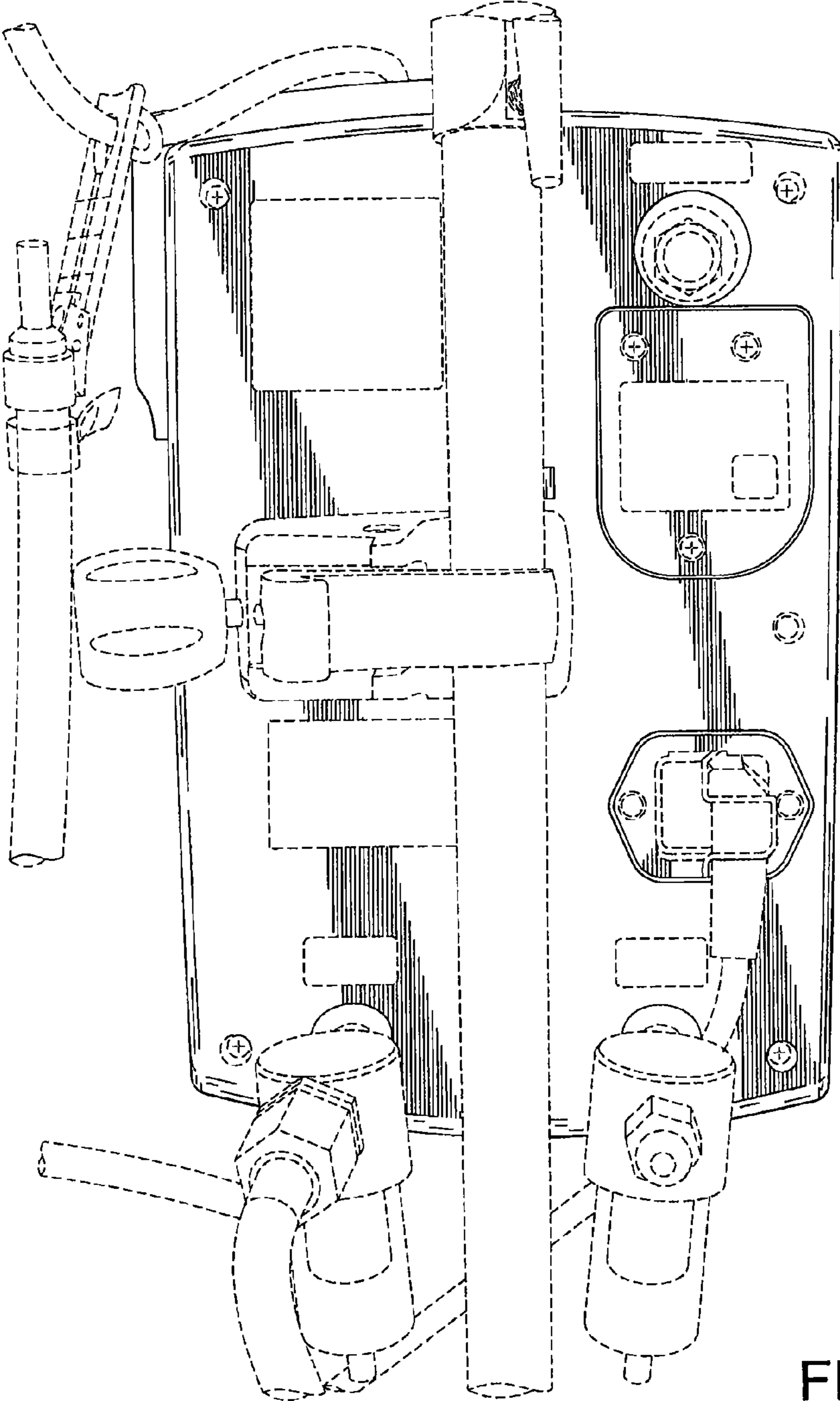

FIG. 6

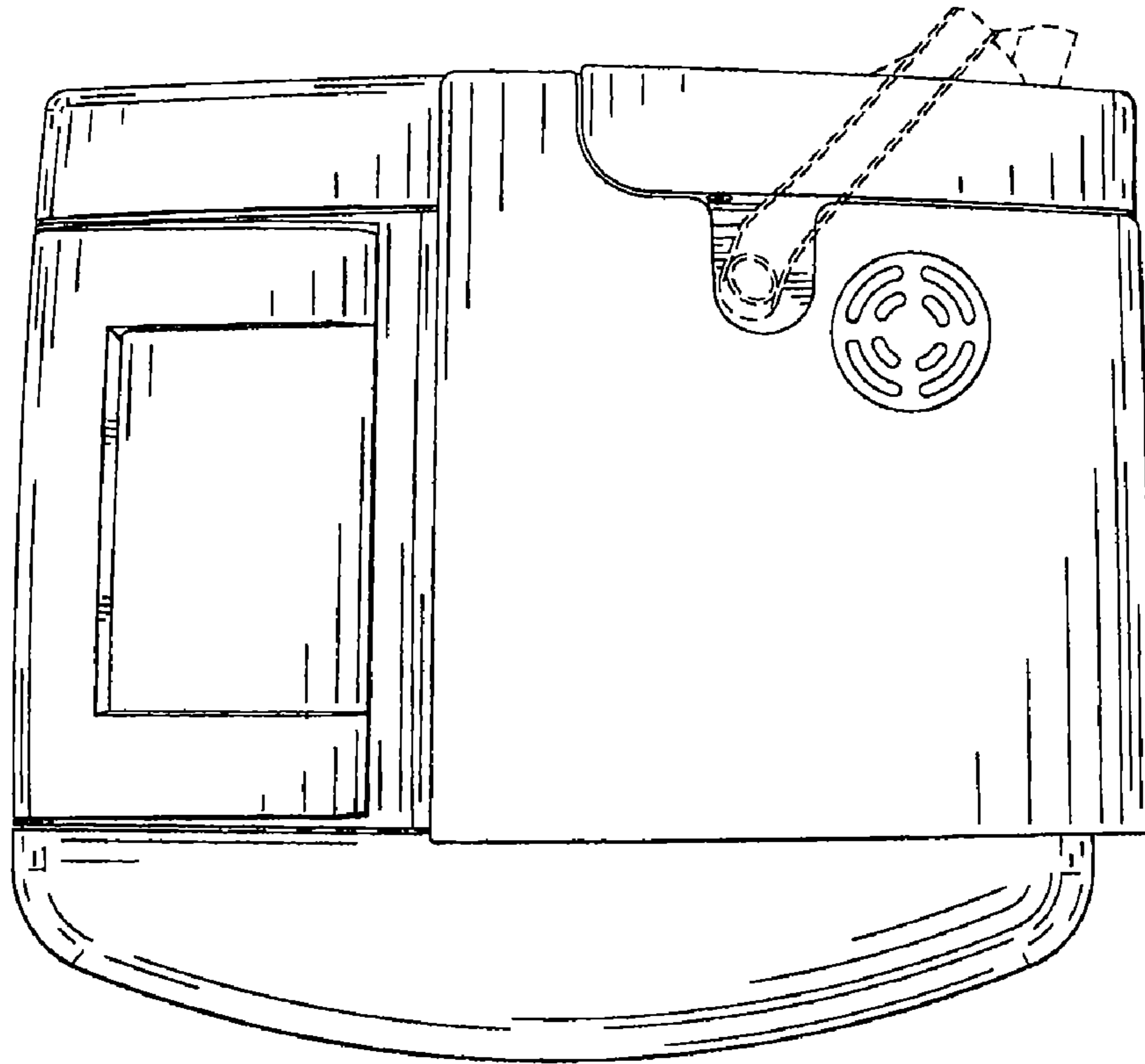

FIG. 7

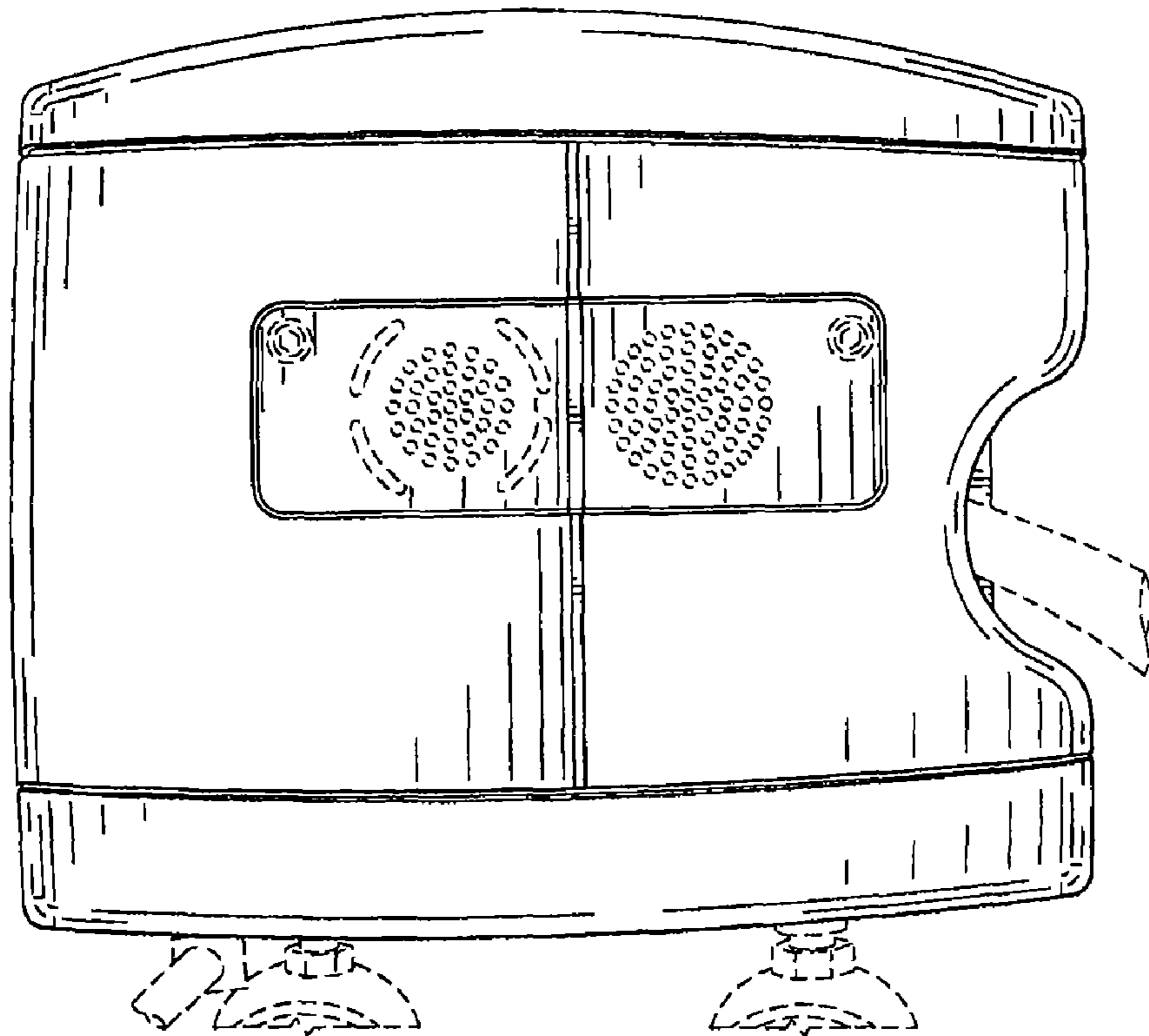

FIG. 8