



US00D640574S

(12) **United States Design Patent**
Giannini

(10) **Patent No.:** **US D640,574 S**
(45) **Date of Patent:** **** Jun. 28, 2011**

(54) **WRISTWATCH**

(75) Inventor: **Frida Giannini**, Florence (IT)

(73) Assignee: **Luxury Timepieces International SA**,
Cortailod (CH)

(**) Term: **14 Years**

(21) Appl. No.: **29/380,692**

(22) Filed: **Dec. 9, 2010**

(30) **Foreign Application Priority Data**

Jun. 9, 2010 (CH) 137002

(51) **LOC (9) Cl.** **10-02**

(52) **U.S. Cl.** **D10/32**

(58) **Field of Classification Search** D10/30-39;
368/276, 281, 282, 285; D11/3, 12
See application file for complete search history.

(56) **References Cited**

U.S. PATENT DOCUMENTS

D109,338 S *	4/1938	Prestinari	D11/24
D112,263 S *	11/1938	Wadsworth	D10/38
2,591,078 A *	4/1952	Lazrus	224/172
2,811,294 A *	10/1957	Sand	224/172
D364,819 S *	12/1995	Wunderman	D10/32
D390,128 S *	2/1998	Toribio	D10/32
D396,811 S *	8/1998	Bulgari	D10/39

D398,542 S *	9/1998	Wunderman	D10/32
D412,446 S *	8/1999	Tse	D10/32
D423,373 S *	4/2000	Wunderman	D10/32
D423,952 S *	5/2000	Inui et al.	D10/39
D456,281 S *	4/2002	Glauser	D10/32
D532,319 S *	11/2006	Bedat	D10/32
D567,112 S *	4/2008	Giannini	D10/31
D567,675 S *	4/2008	Giannini	D10/31
D575,167 S *	8/2008	Giannini	D10/32
D628,910 S *	12/2010	Giannini	D10/32

* cited by examiner

Primary Examiner — Lucy Lieberman

(74) *Attorney, Agent, or Firm* — Oblon, Spivak,
McClelland, Maier & Neustadt, L.L.P.

(57) **CLAIM**

The ornamental design for a wristwatch, as shown and described.

DESCRIPTION

FIG. 1 is a front and right side perspective view of a wristwatch;

FIG. 2 is a front elevational view thereof;

FIG. 3 is a rear elevational view thereof;

FIG. 4 is a right side elevational view thereof;

FIG. 5 is a left side elevational view thereof;

FIG. 6 is a bottom plan view thereof; and,

FIG. 7 is a top plan view thereof.

The broken lines in the drawings depict environmental subject matter only and form no part of the claimed design.

1 Claim, 4 Drawing Sheets

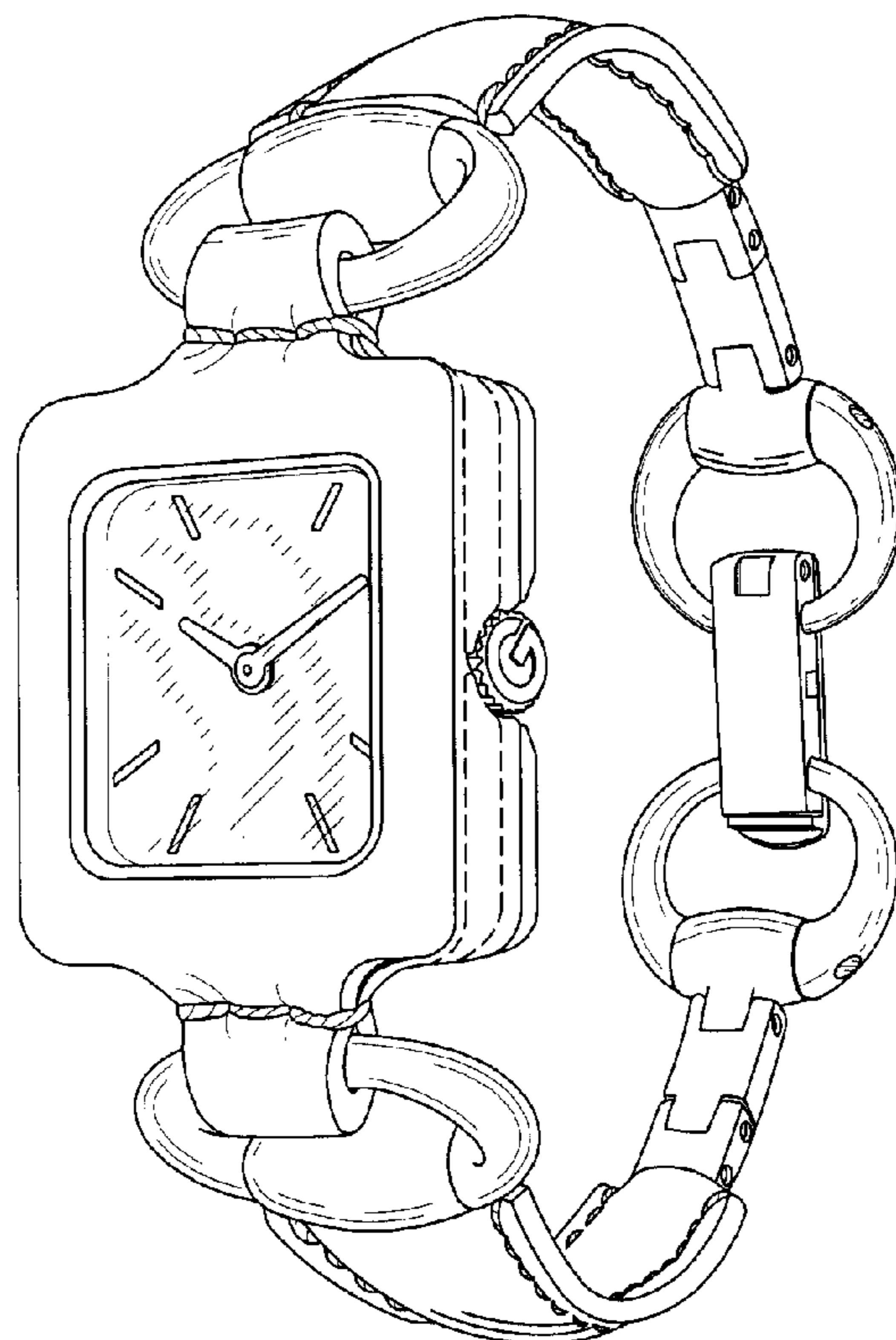

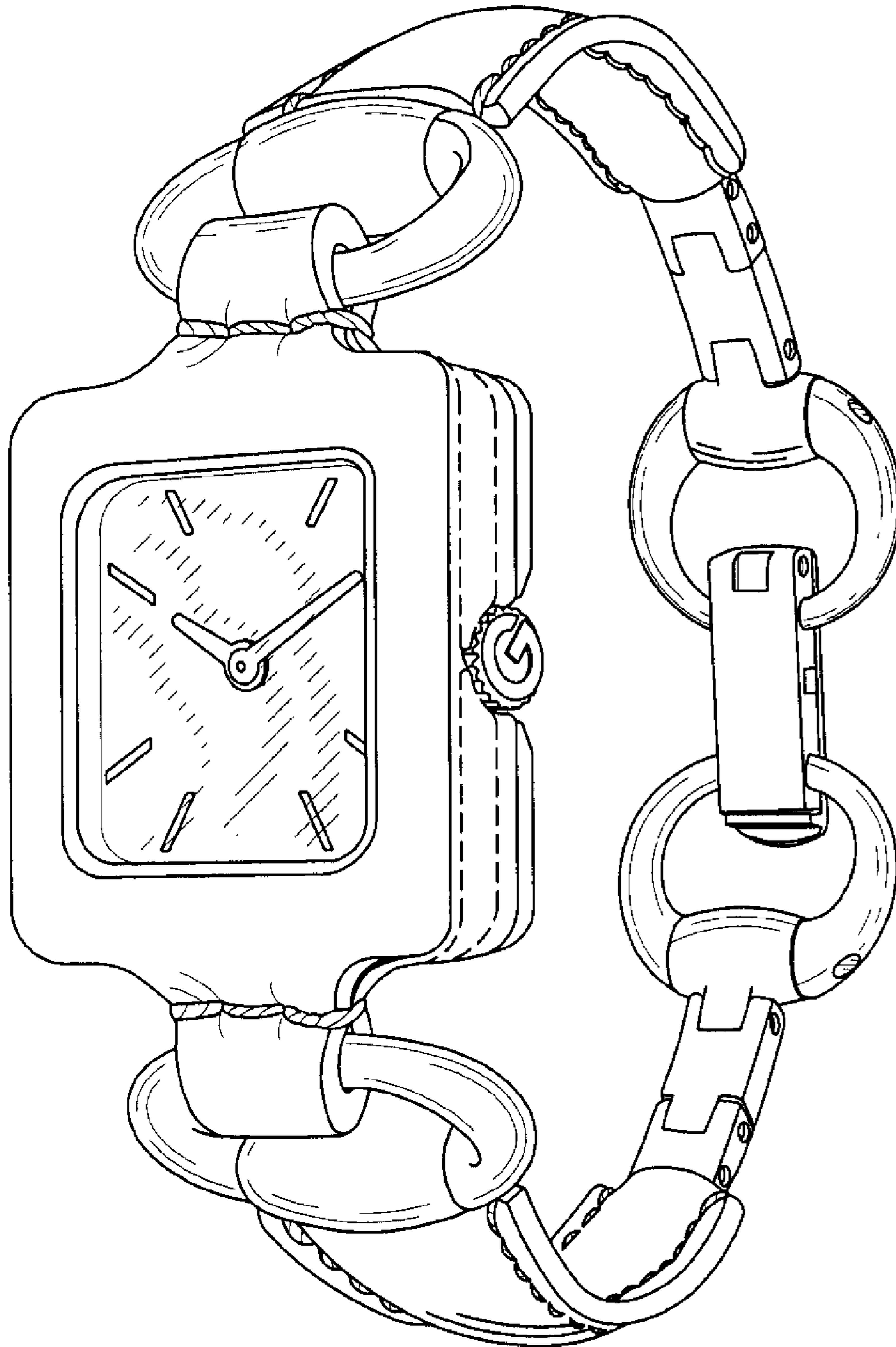

FIG. 1

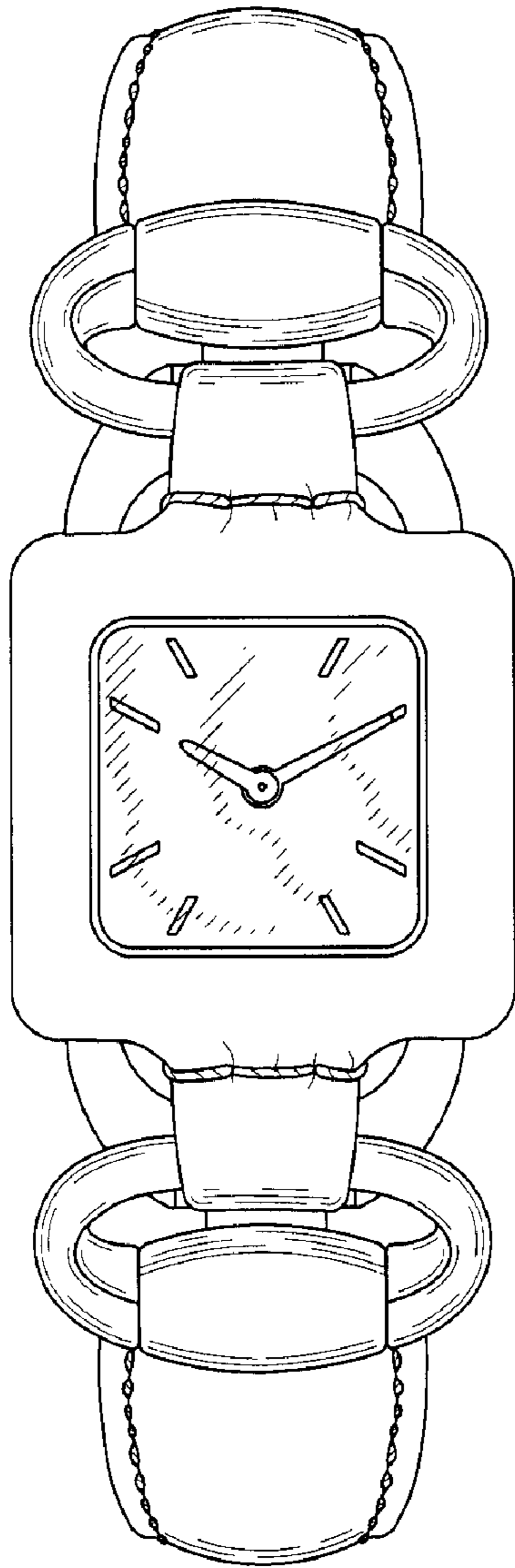

FIG. 2

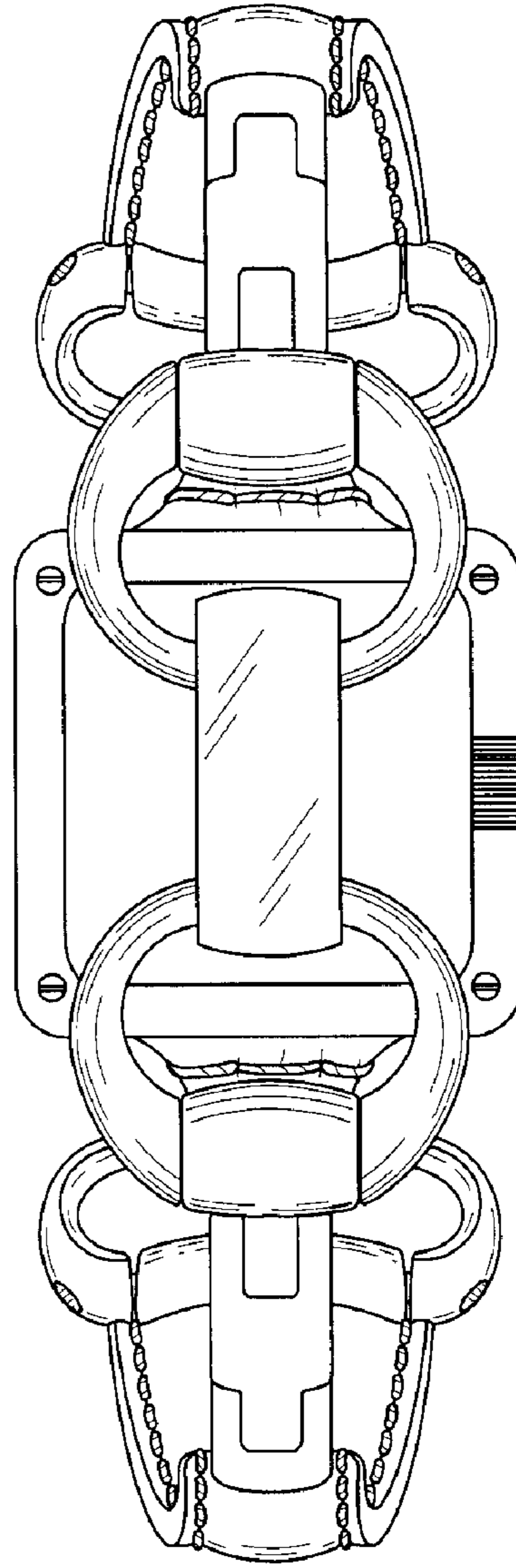

FIG. 3

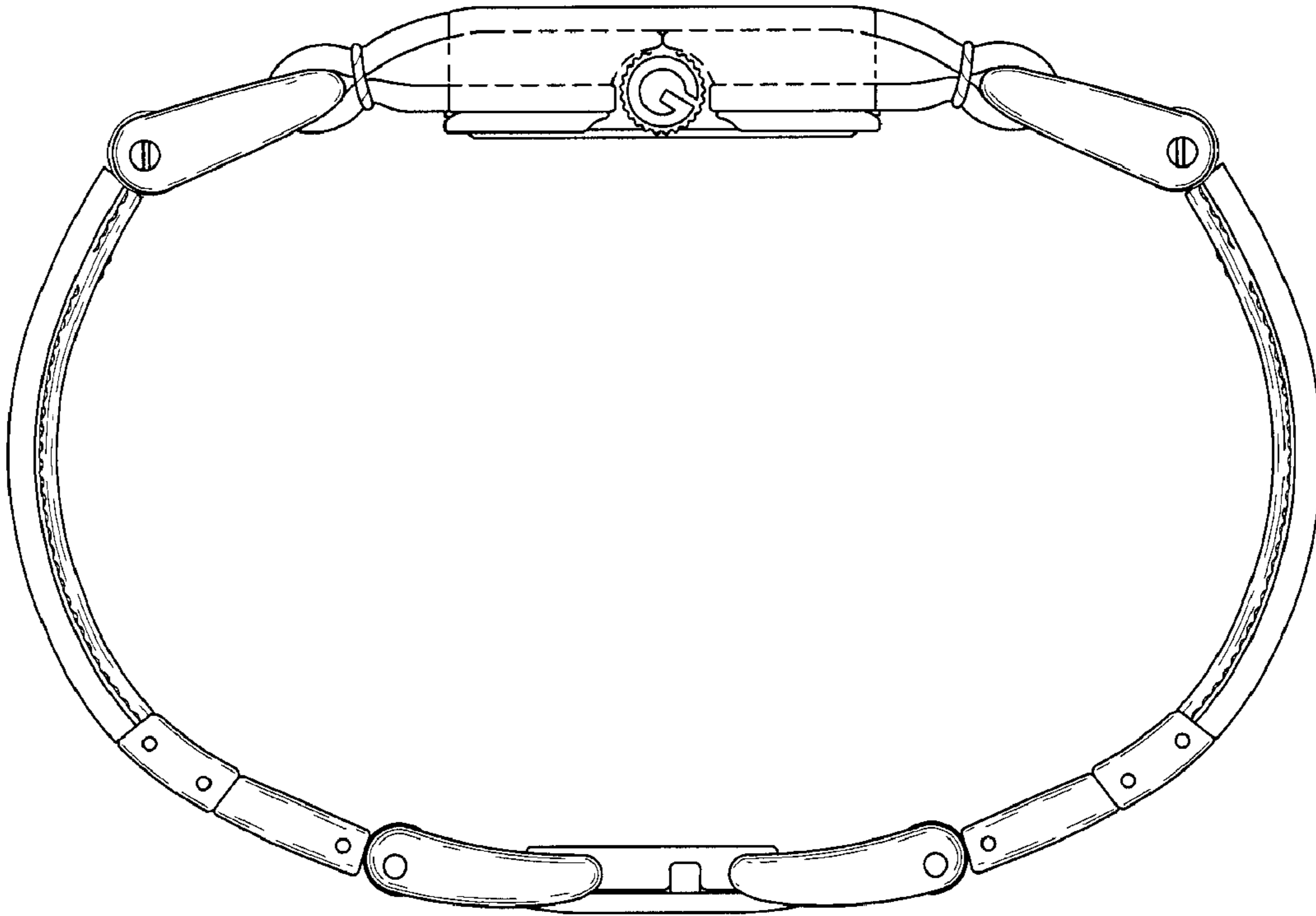

FIG. 4

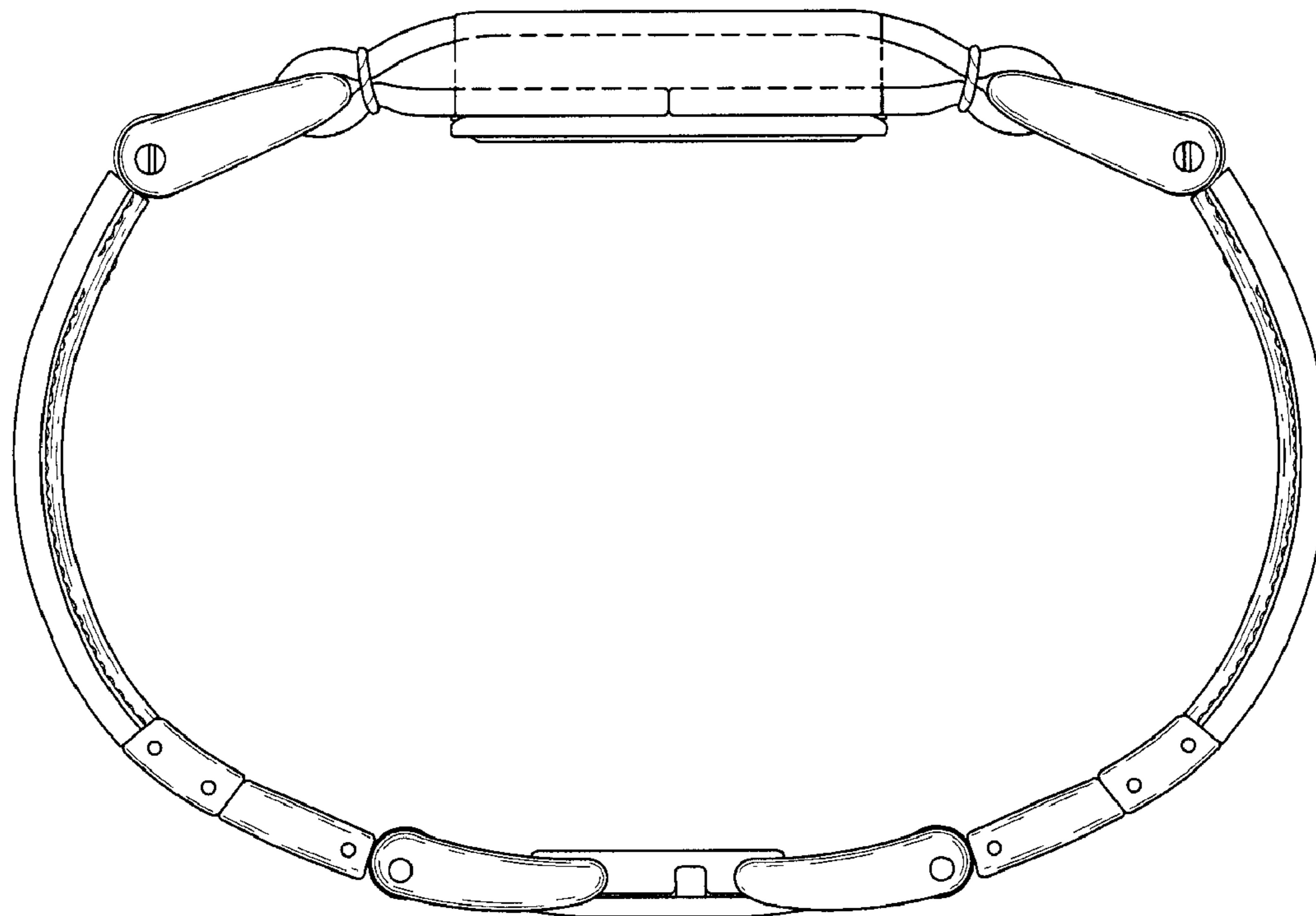

FIG. 5

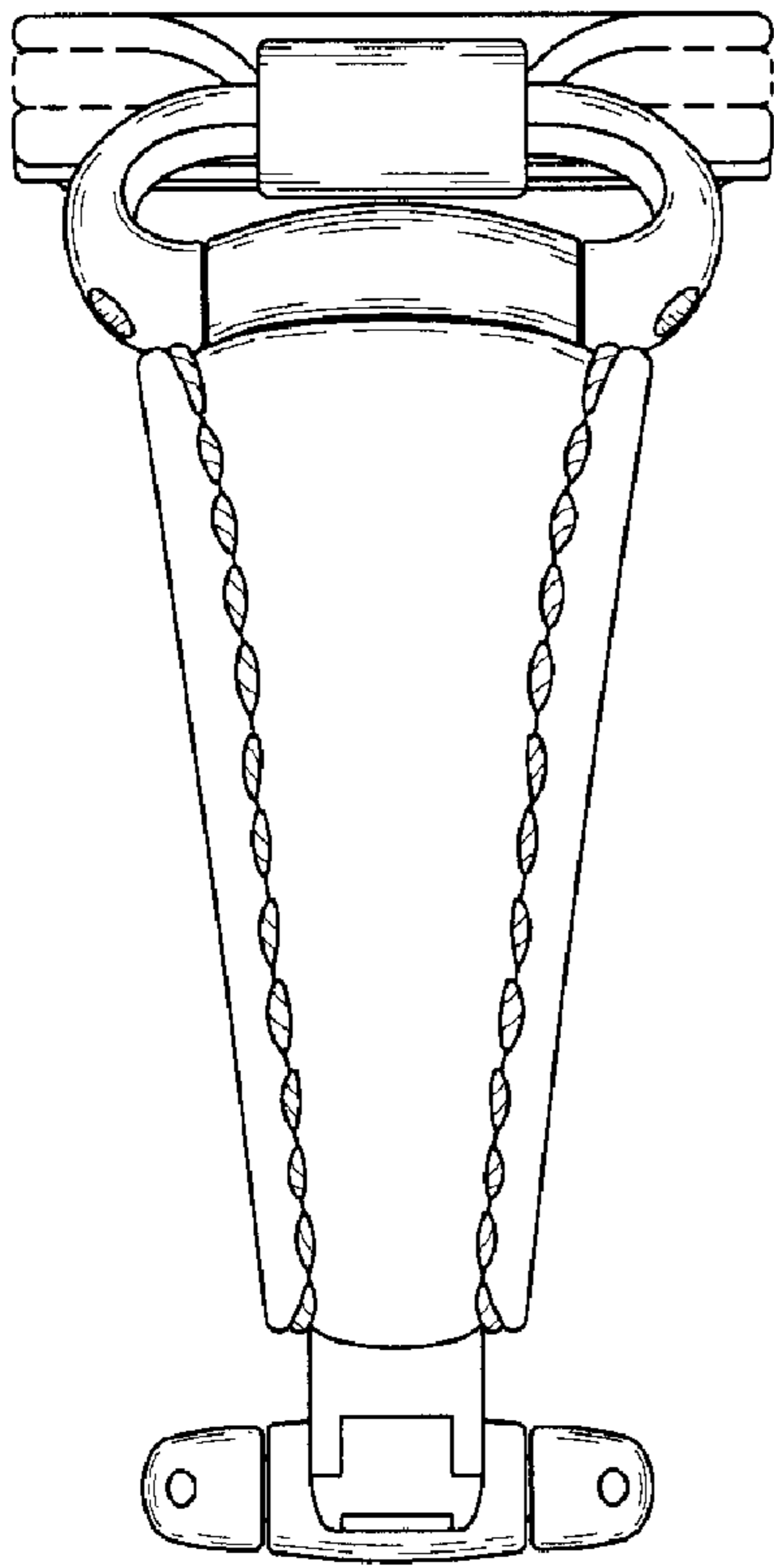

FIG. 6

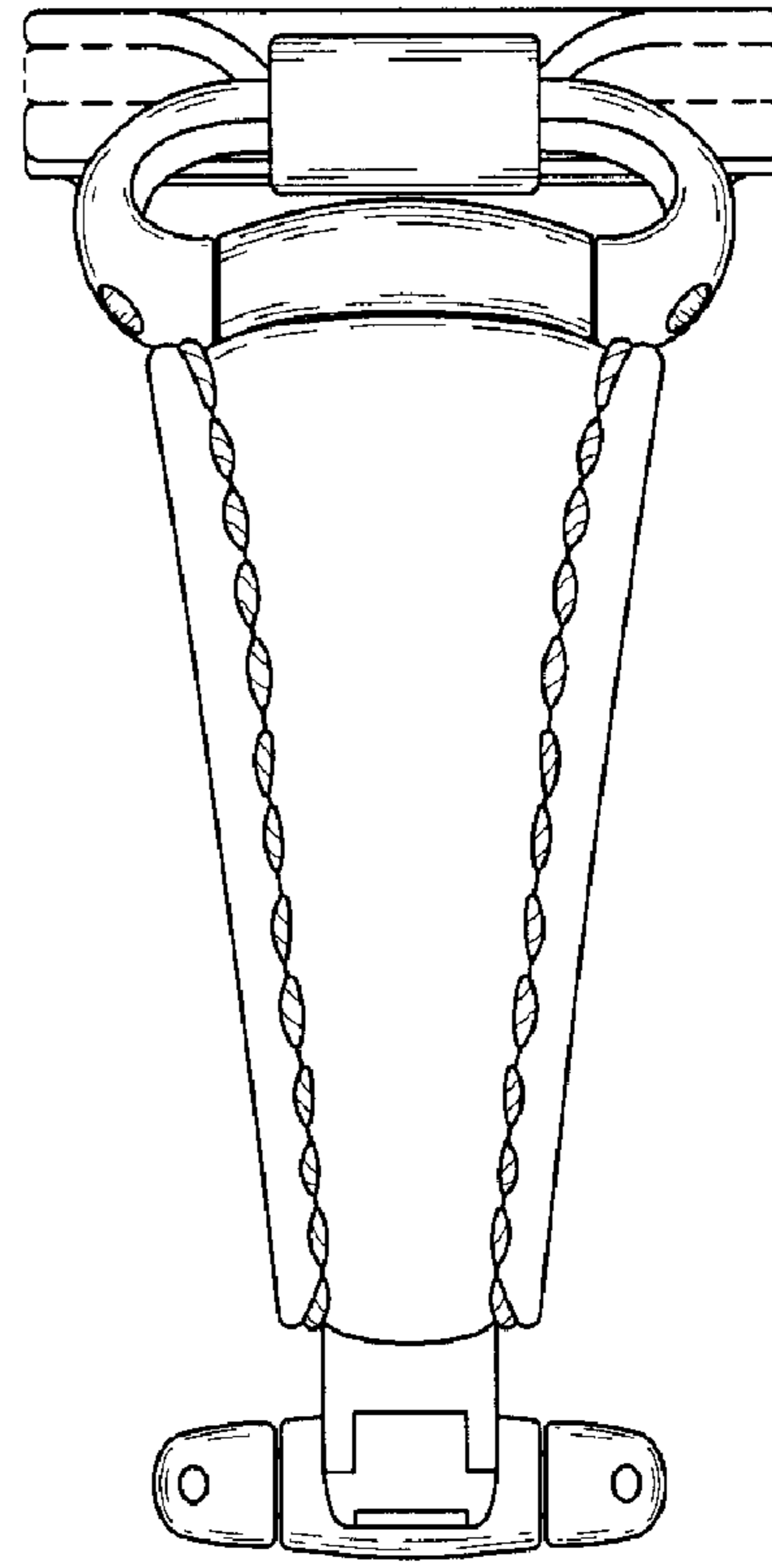

FIG. 7