

US00D640468S

(12) **United States Design Patent**
Libuda

(10) **Patent No.:** **US D640,468 S**
(45) **Date of Patent:** **** Jun. 28, 2011**

(54) **EXTENDABLE SUITCASE DISPLAY**

(76) Inventor: **Georg Günter Libuda**, Schwenningen
(DE)

(**) Term: **14 Years**

(21) Appl. No.: **29/369,295**

(22) Filed: **Sep. 6, 2010**

(51) **LOC (9) Cl.** **03-01**

(52) **U.S. Cl.** **D3/272; D3/274; D3/279; D3/284**

(58) **Field of Classification Search** **D3/273,**
D3/272, 274, 279-293; 190/100-127, 18 A,
190/16-17, 15 R, 15 A, 1, 15.1; 280/37-38
See application file for complete search history.

(56) **References Cited**

U.S. PATENT DOCUMENTS

2,472,491	A *	6/1949	Quinton	280/37
2,905,480	A	9/1959	Giovannelli	
4,006,821	A *	2/1977	Sautter	190/17
D270,017	S *	8/1983	DiDonna	D3/279
D351,502	S *	10/1994	Weir et al.	D3/272
D583,150	S *	12/2008	Chung et al.	D3/279
D618,459	S *	6/2010	Thuma et al.	D3/279
2003/0079949	A1 *	5/2003	Harvey	190/18 A
2005/0126872	A1 *	6/2005	Dror	190/107
2006/0096821	A1 *	5/2006	McKaba	190/9
2006/0137949	A1 *	6/2006	Levinson et al.	190/18 A
2007/0089954	A1	4/2007	Eardley et al.	
2007/0295570	A1 *	12/2007	Campbell et al.	190/15 R

FOREIGN PATENT DOCUMENTS

DE	2318717	10/1973
DE	402009004026	11/2009
FR	613735	11/1926

* cited by examiner

Primary Examiner — Jennifer Rivard

(74) *Attorney, Agent, or Firm* — Smartpat PLC; Axel Nix

(57) **CLAIM**

I claim the ornamental design for an extendable suitcase display, as shown and described.

DESCRIPTION

FIG. 1 is a perspective view of an extendable suitcase display showing my new design in a closed state;
 FIG. 2 is a front view thereof;
 FIG. 3 is a rear view thereof;
 FIG. 4 is view as in FIG. 3, showing an extended handle;
 FIG. 5 is a top view thereof;
 FIG. 6 is a bottom view thereof;
 FIG. 7 is a left side view thereof;
 FIG. 8 is a right side view thereof;
 FIG. 9 is a perspective view of the extendable suitcase display as in FIG. 1, showing my new design in an open state;
 FIG. 10 is a front view thereof;
 FIG. 11 is a rear view thereof;
 FIG. 12 is view as in FIG. 11, showing an extended handle;
 FIG. 13 is a top view thereof;
 FIG. 14 is a bottom view thereof;
 FIG. 15 is a left side view thereof;
 FIG. 16 is a right side view thereof;
 FIG. 17 is a perspective view of the extendable suitcase display as in FIG. 1, showing my new design in an extended state;
 FIG. 18 is a front view thereof;
 FIG. 19 is a rear view thereof;
 FIG. 20 is view as in FIG. 19, showing an extended handle;
 FIG. 21 is a left side view thereof; and,
 FIG. 22 is a right side view thereof.

1 Claim, 20 Drawing Sheets

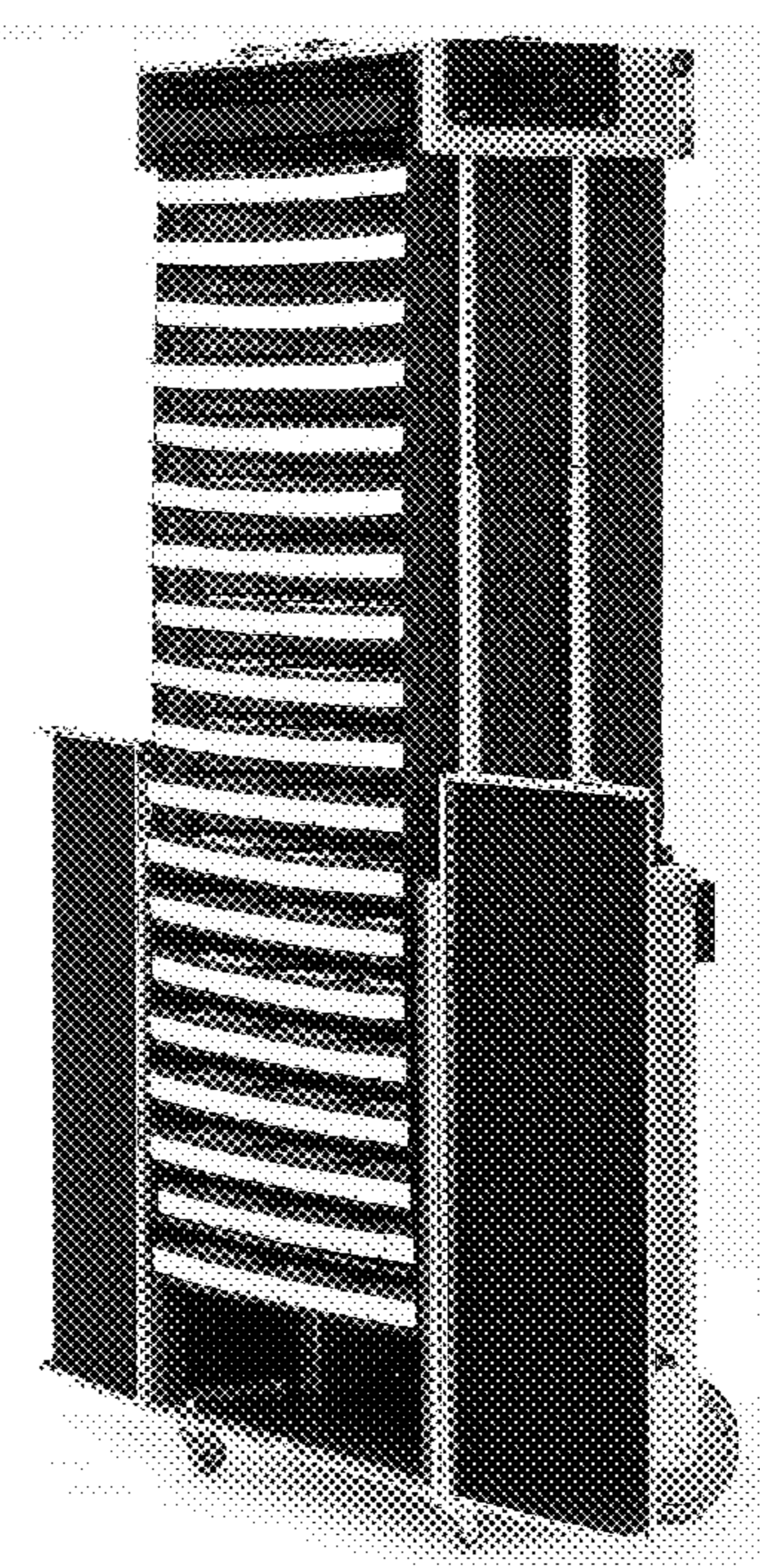
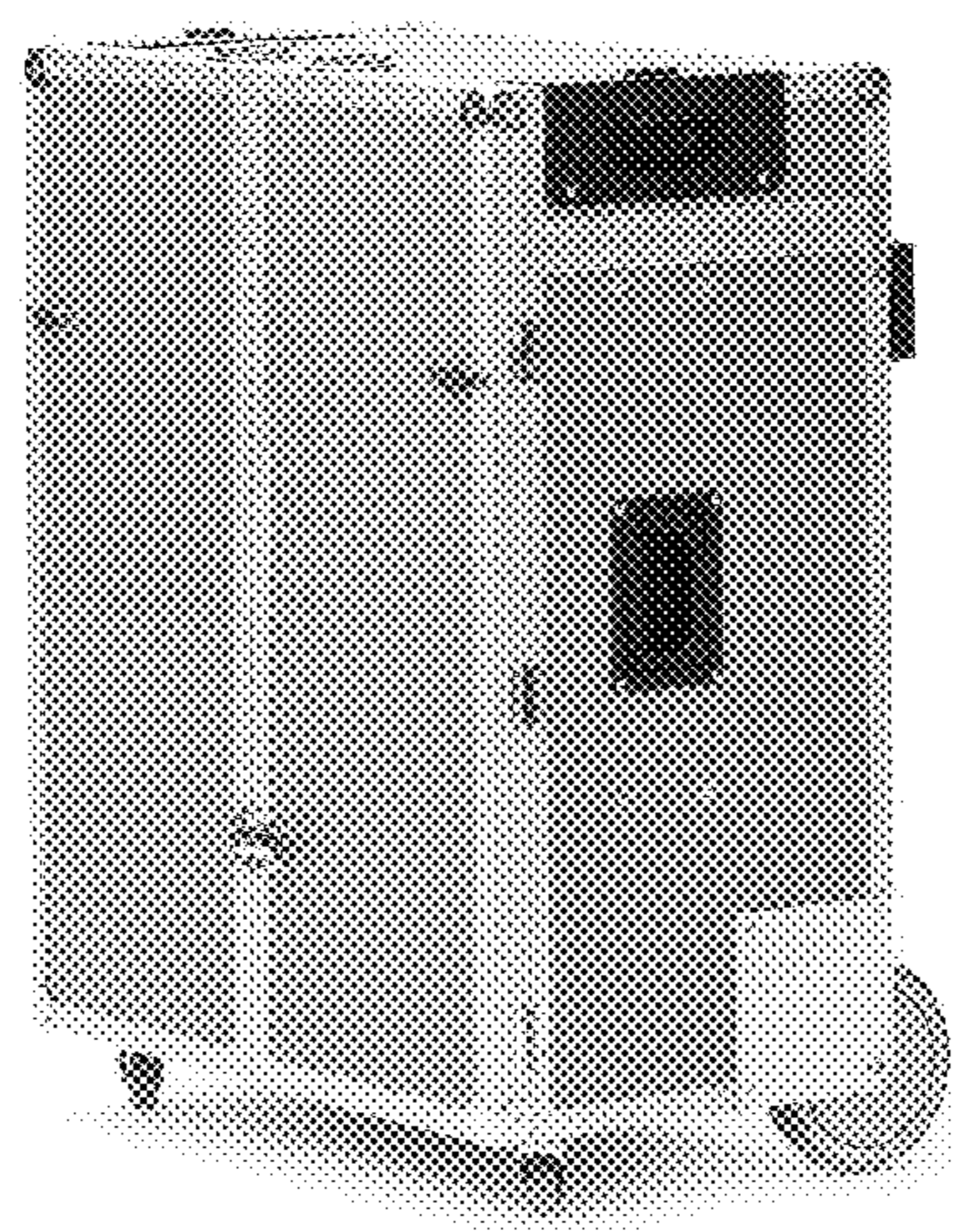



FIG. 1



FIG. 2

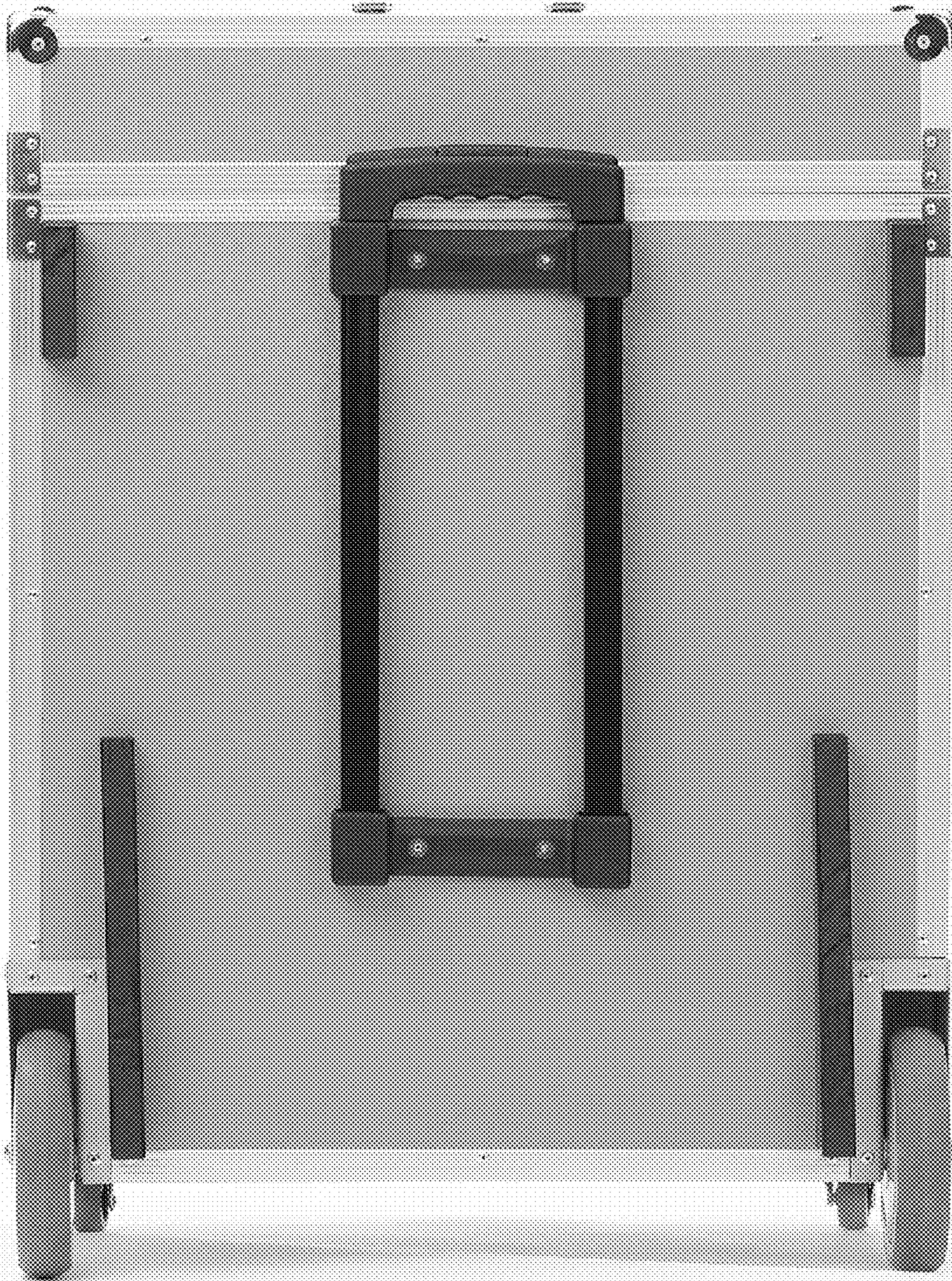

FIG. 3

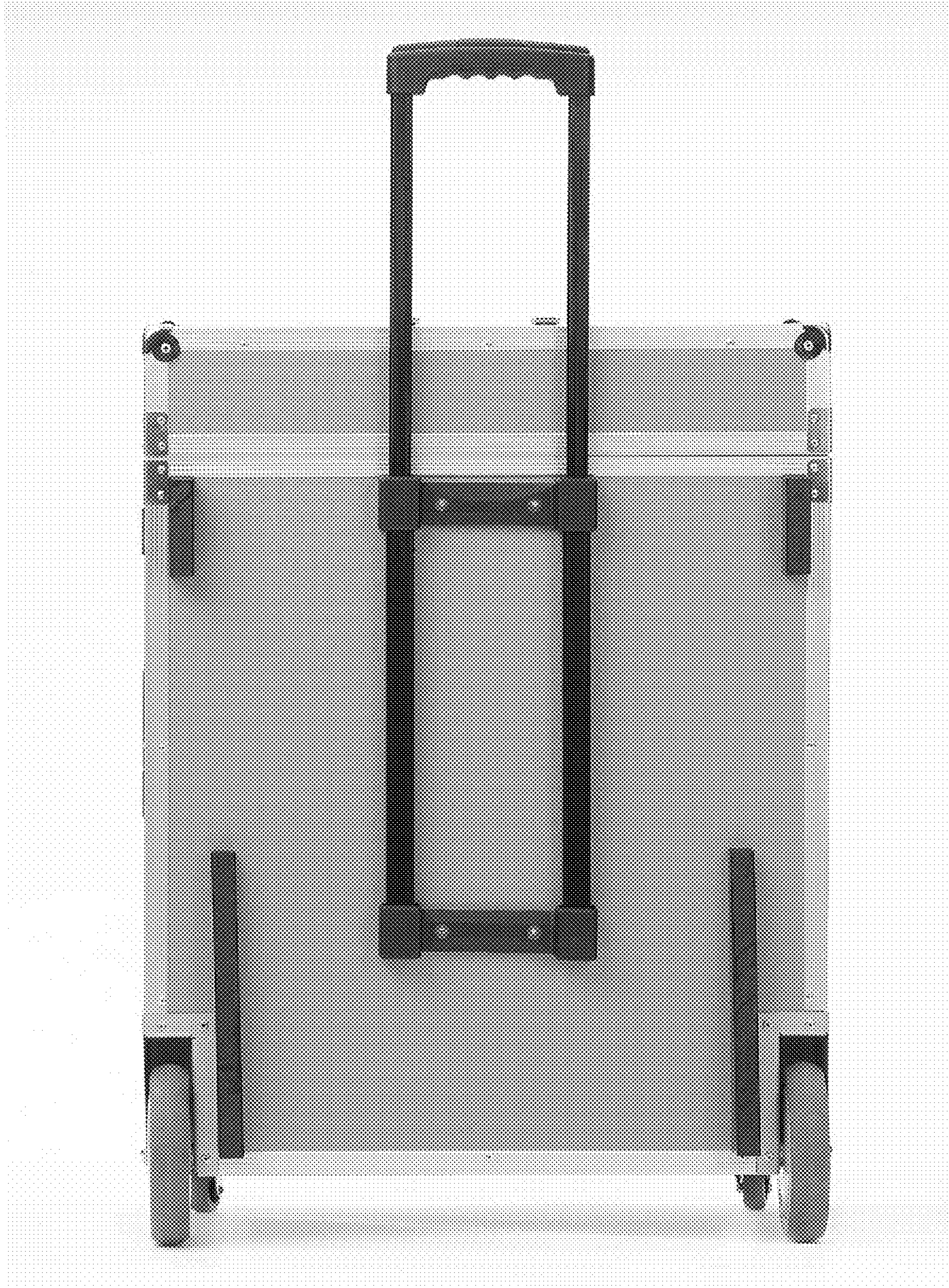

FIG. 4

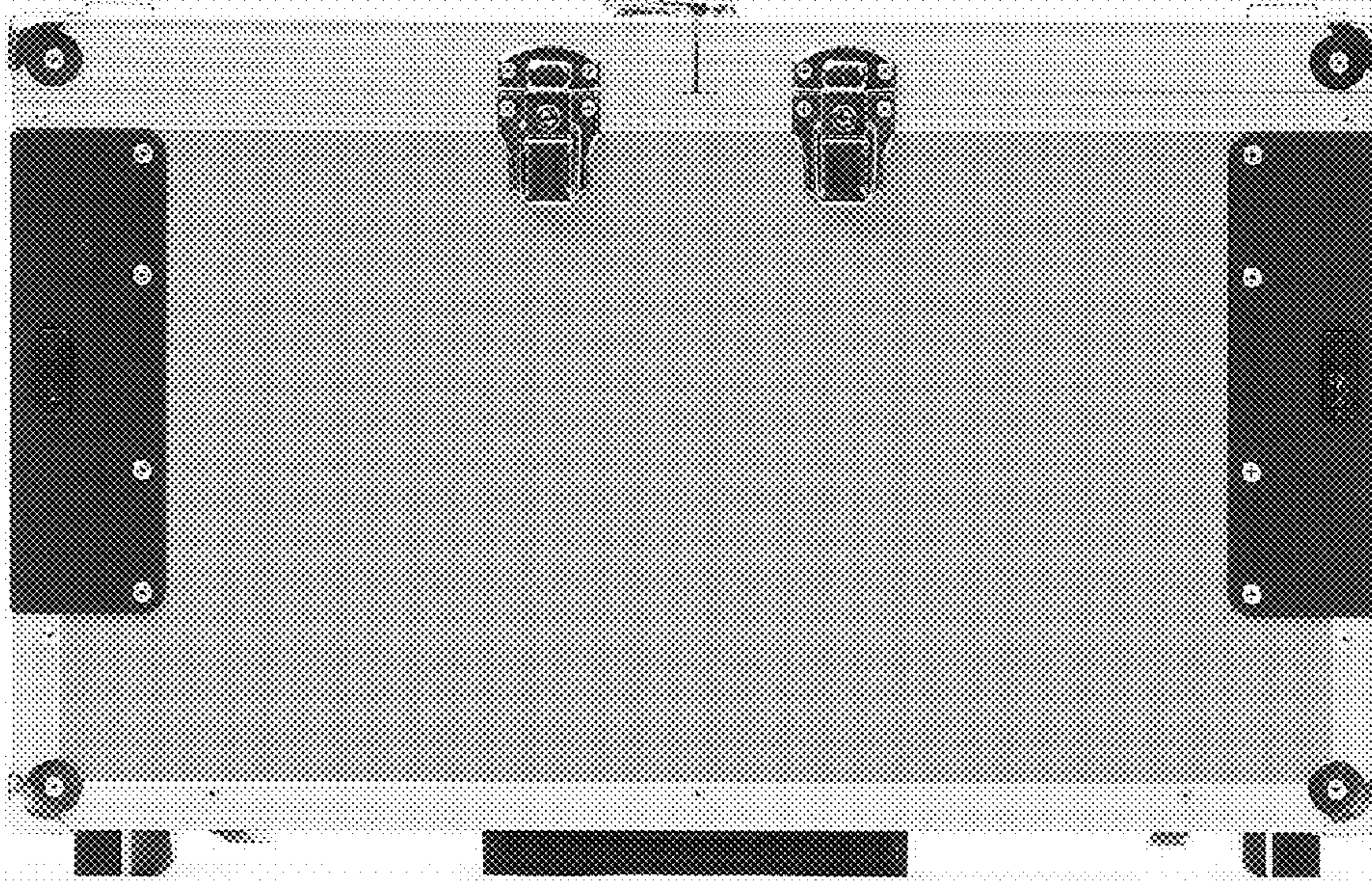

FIG. 5

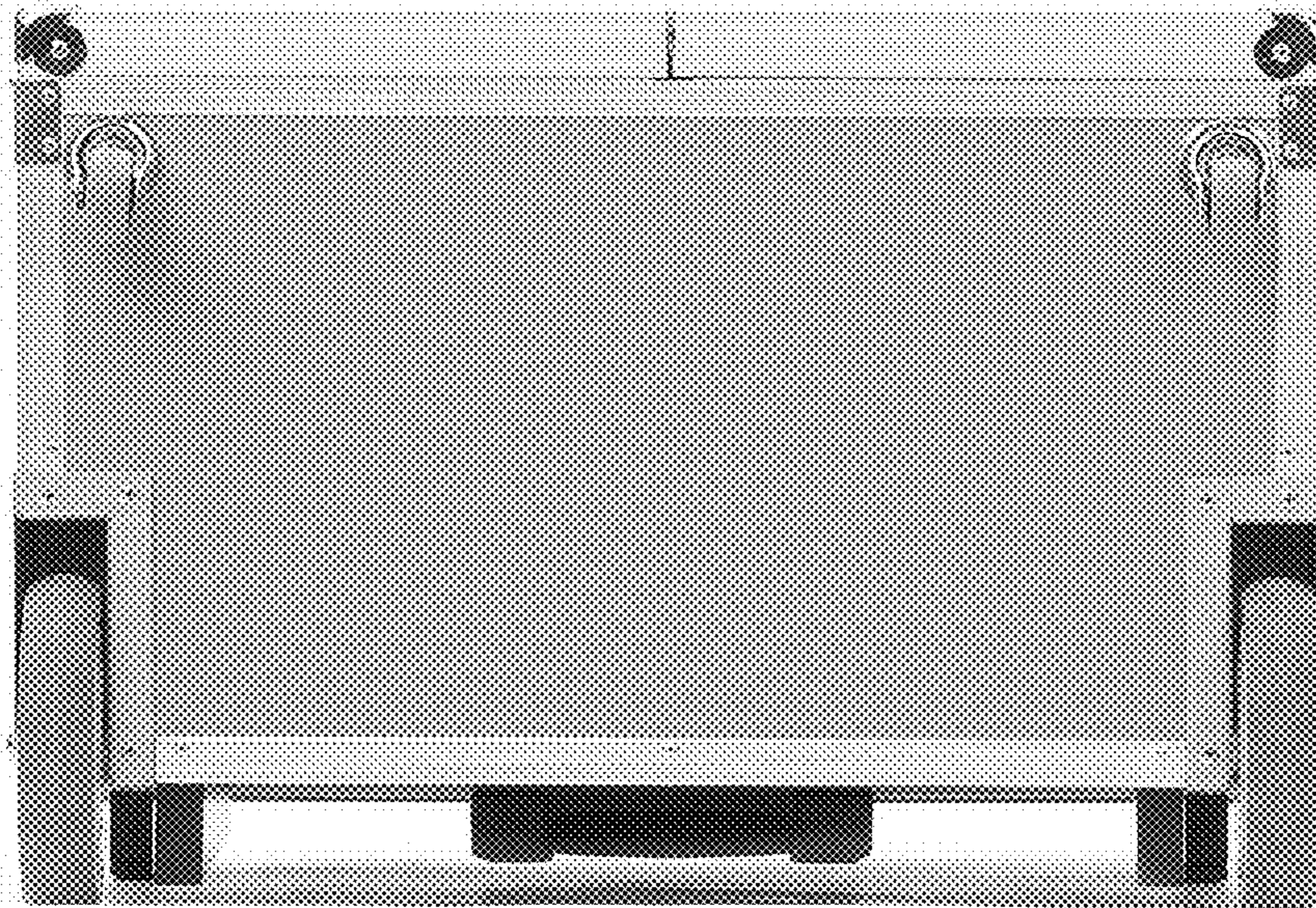

FIG. 6



FIG. 7

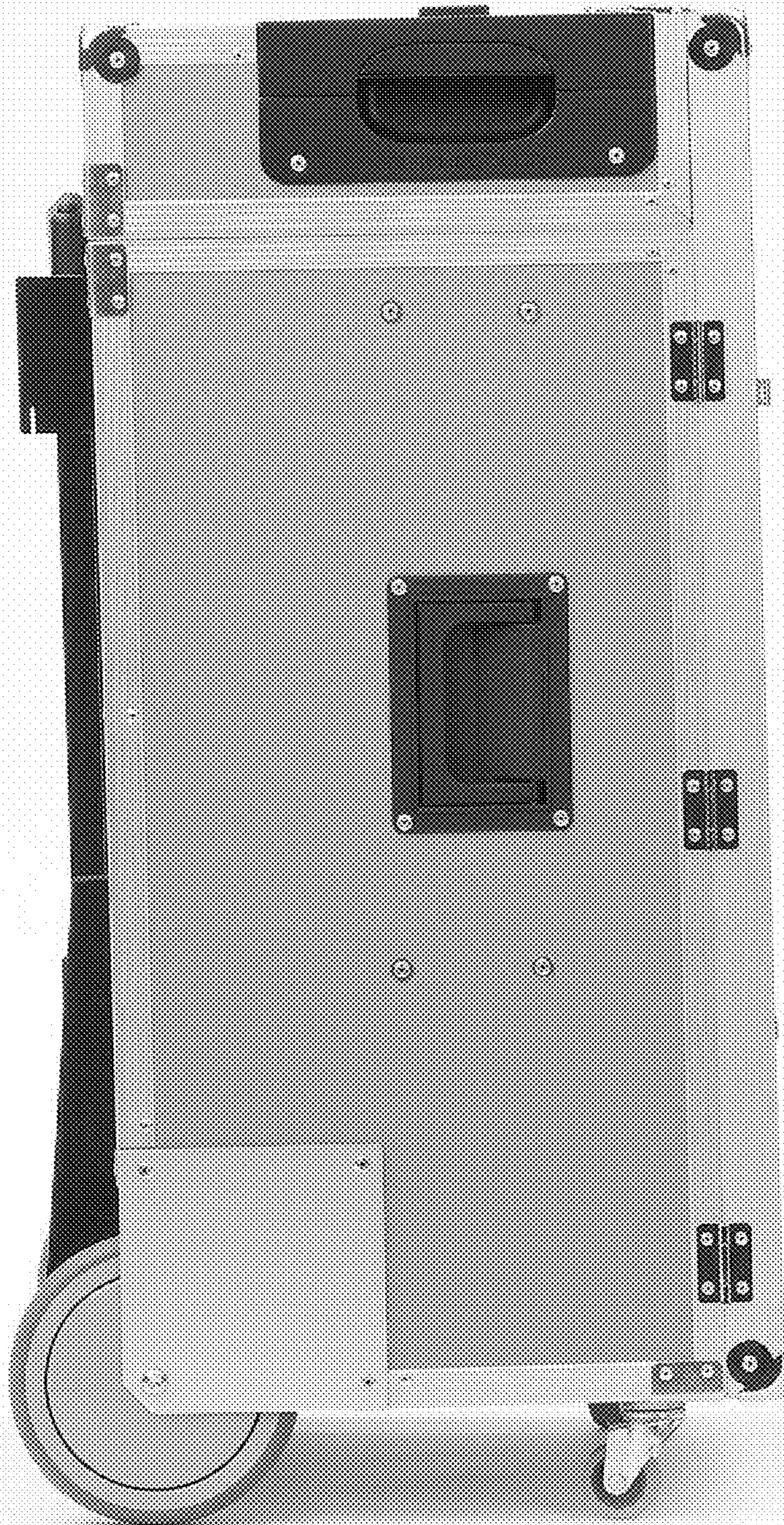

FIG. 8



FIG. 9



FIG. 10

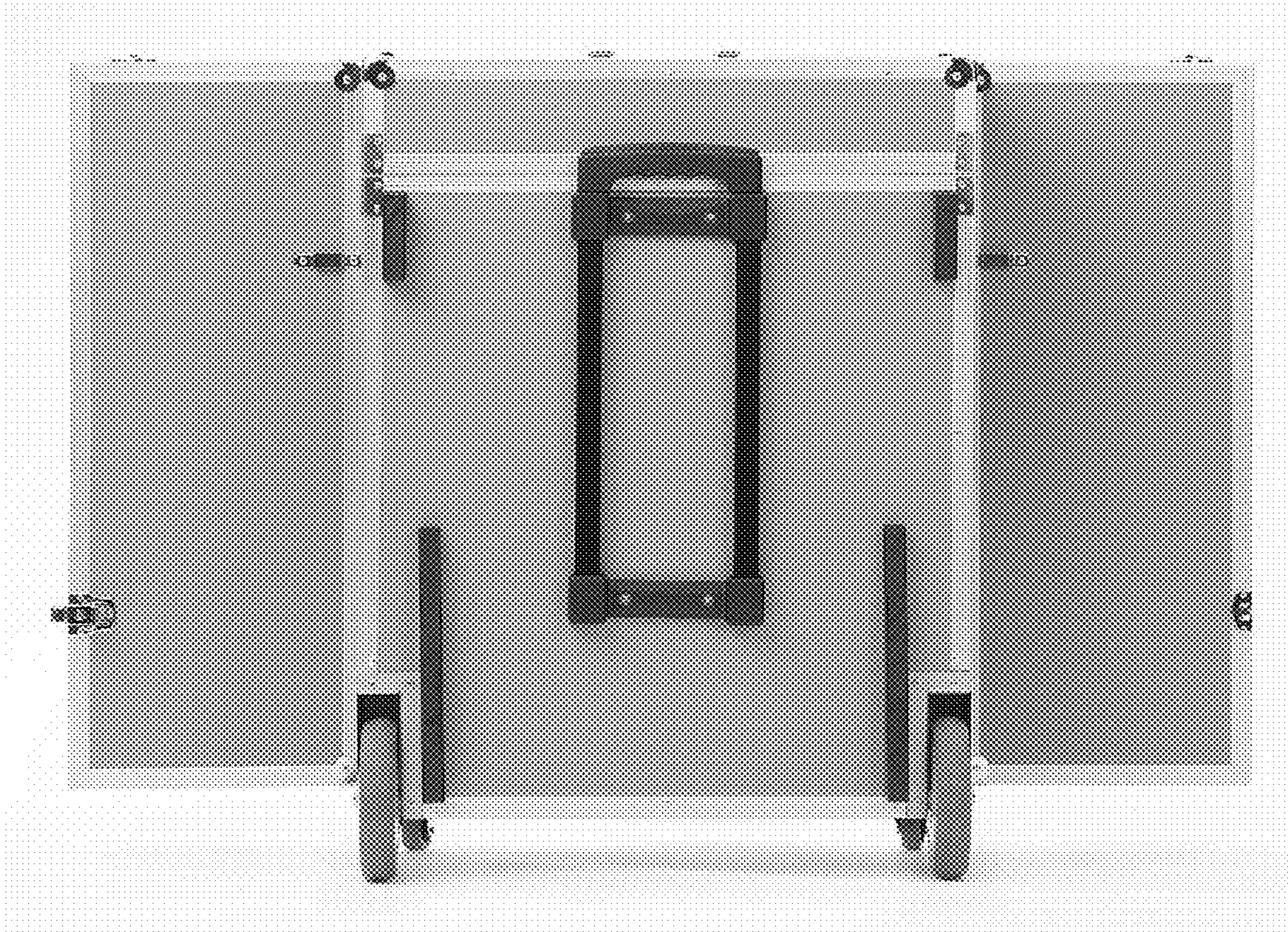

FIG. 11



FIG. 12

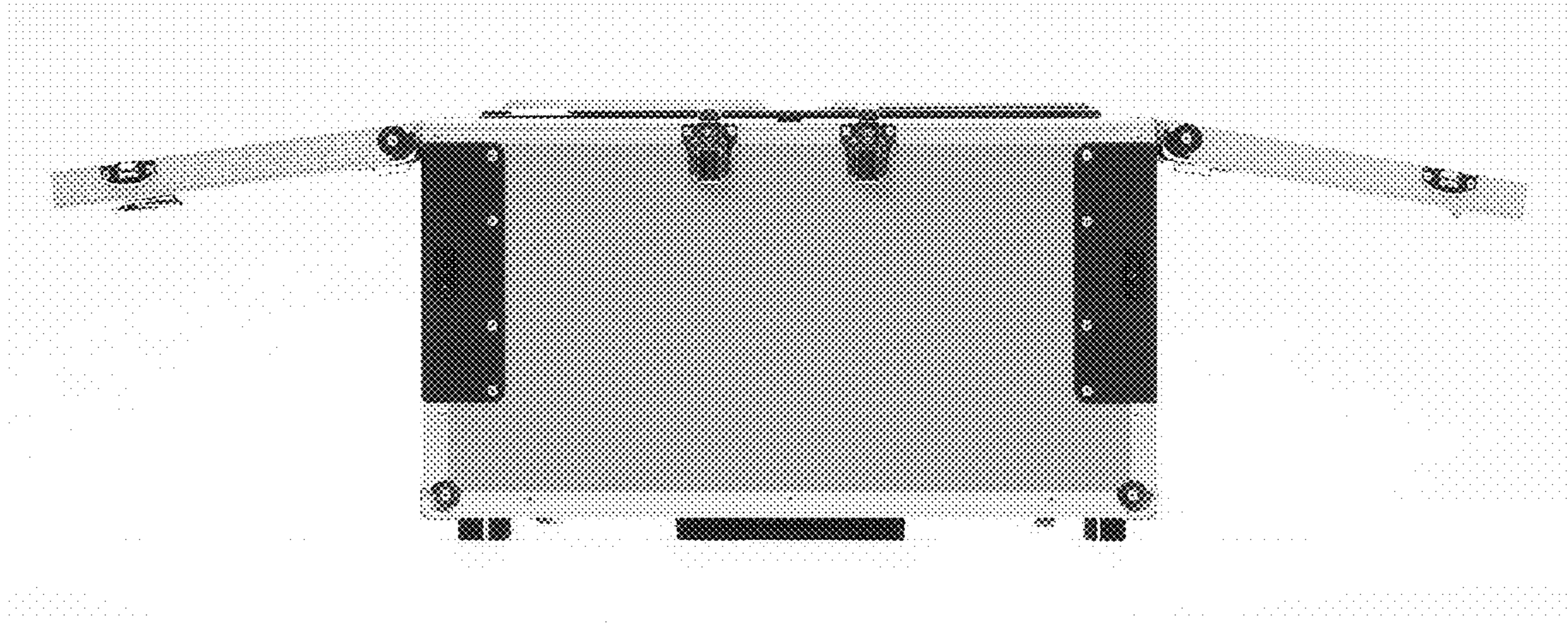

FIG. 13

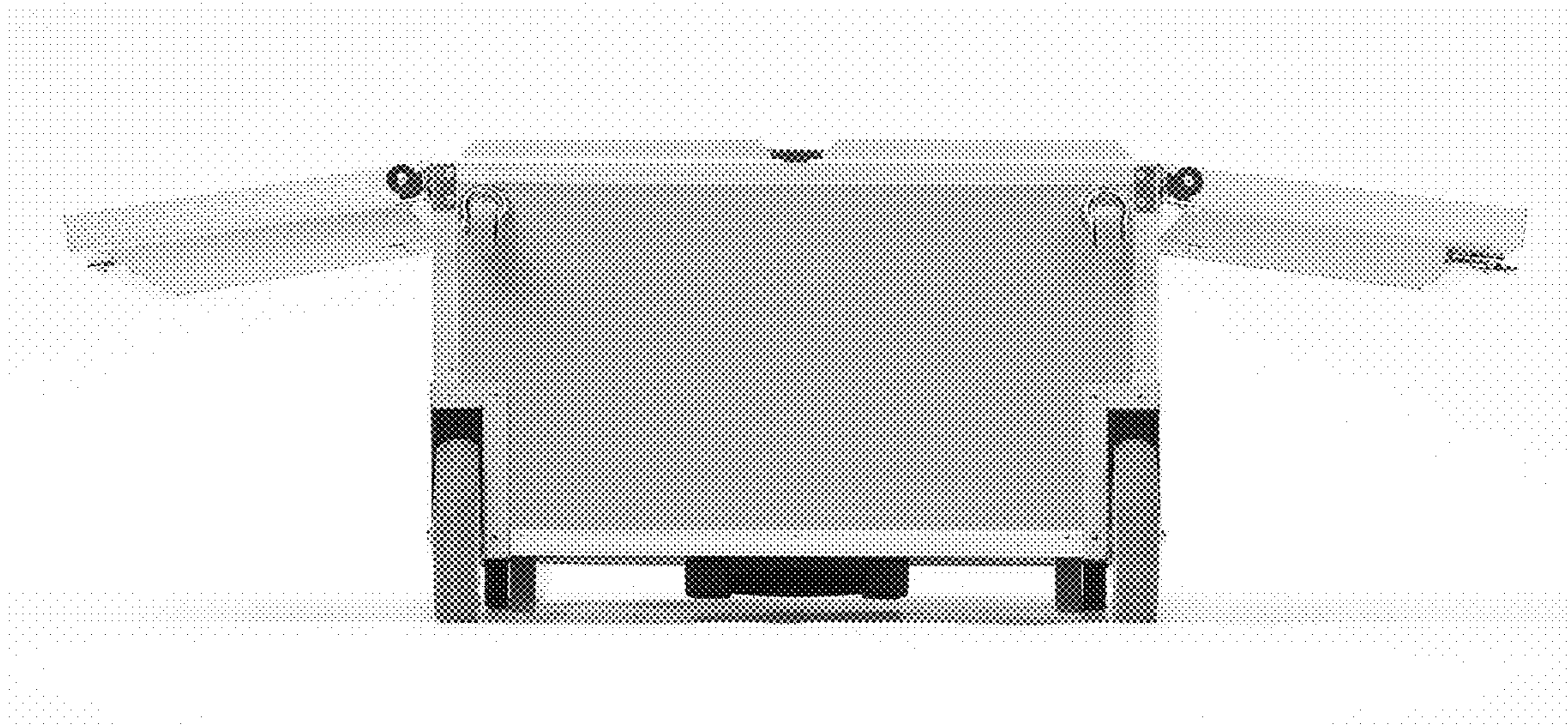

FIG. 14

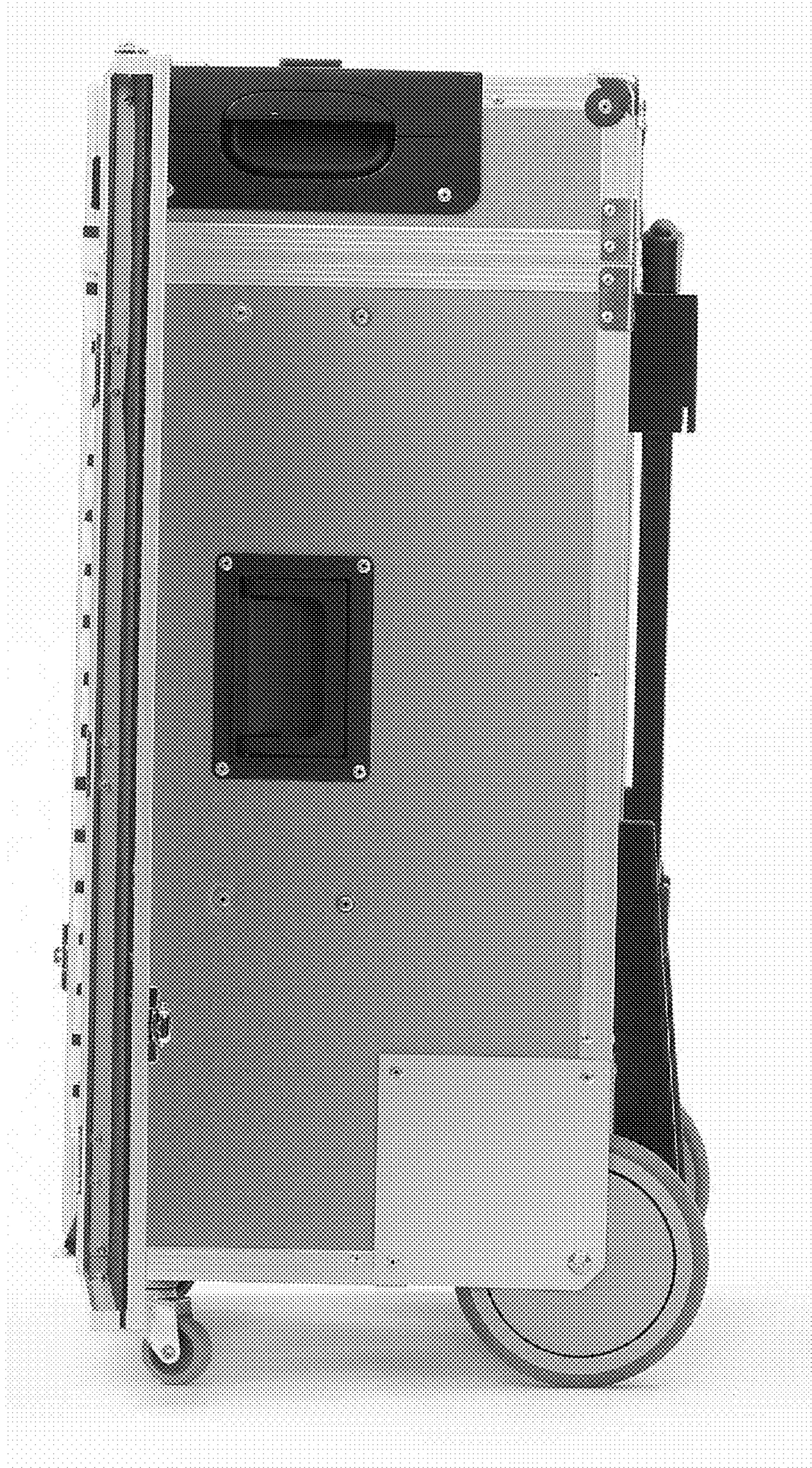

FIG. 15

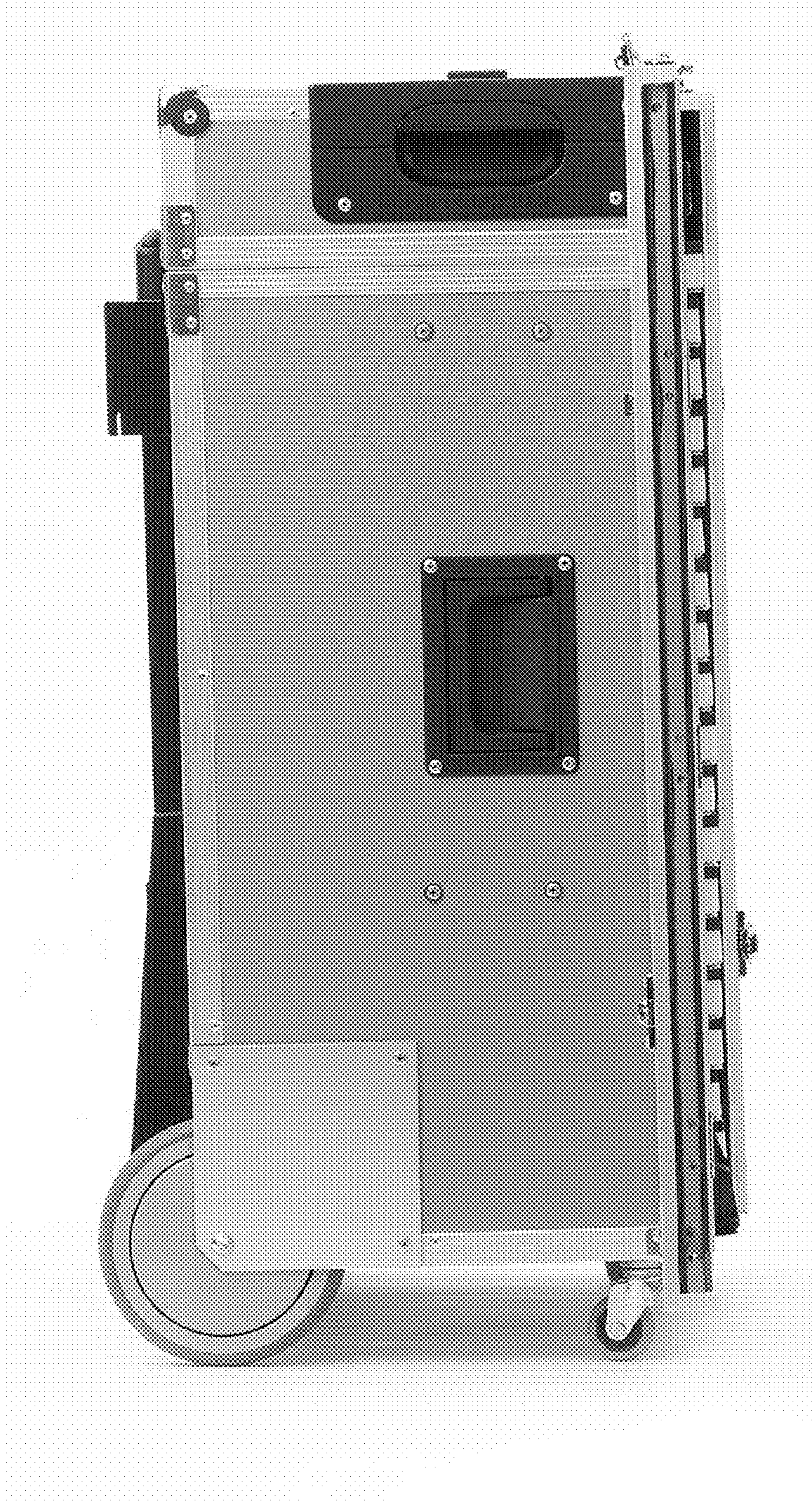

FIG. 16

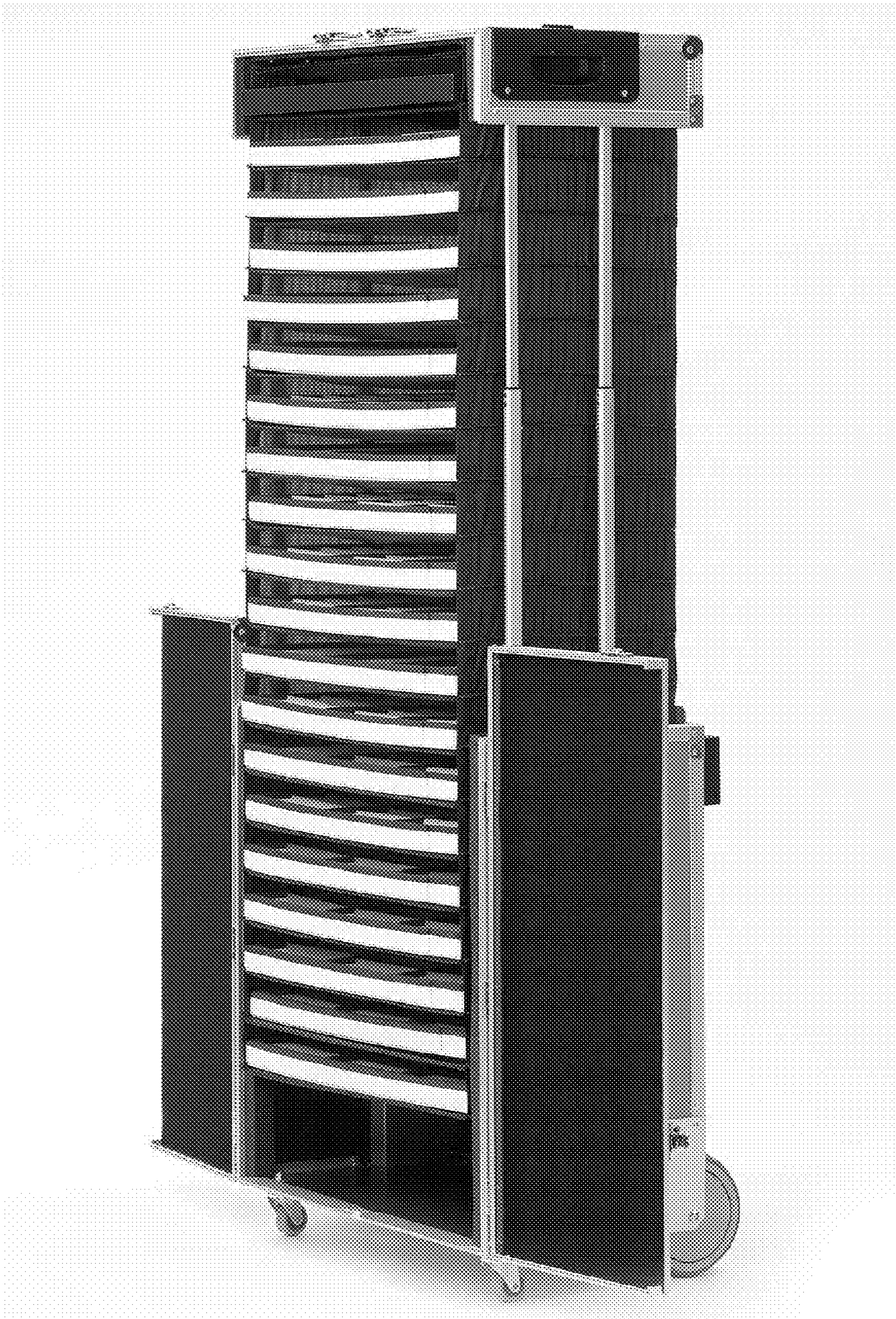

FIG. 17

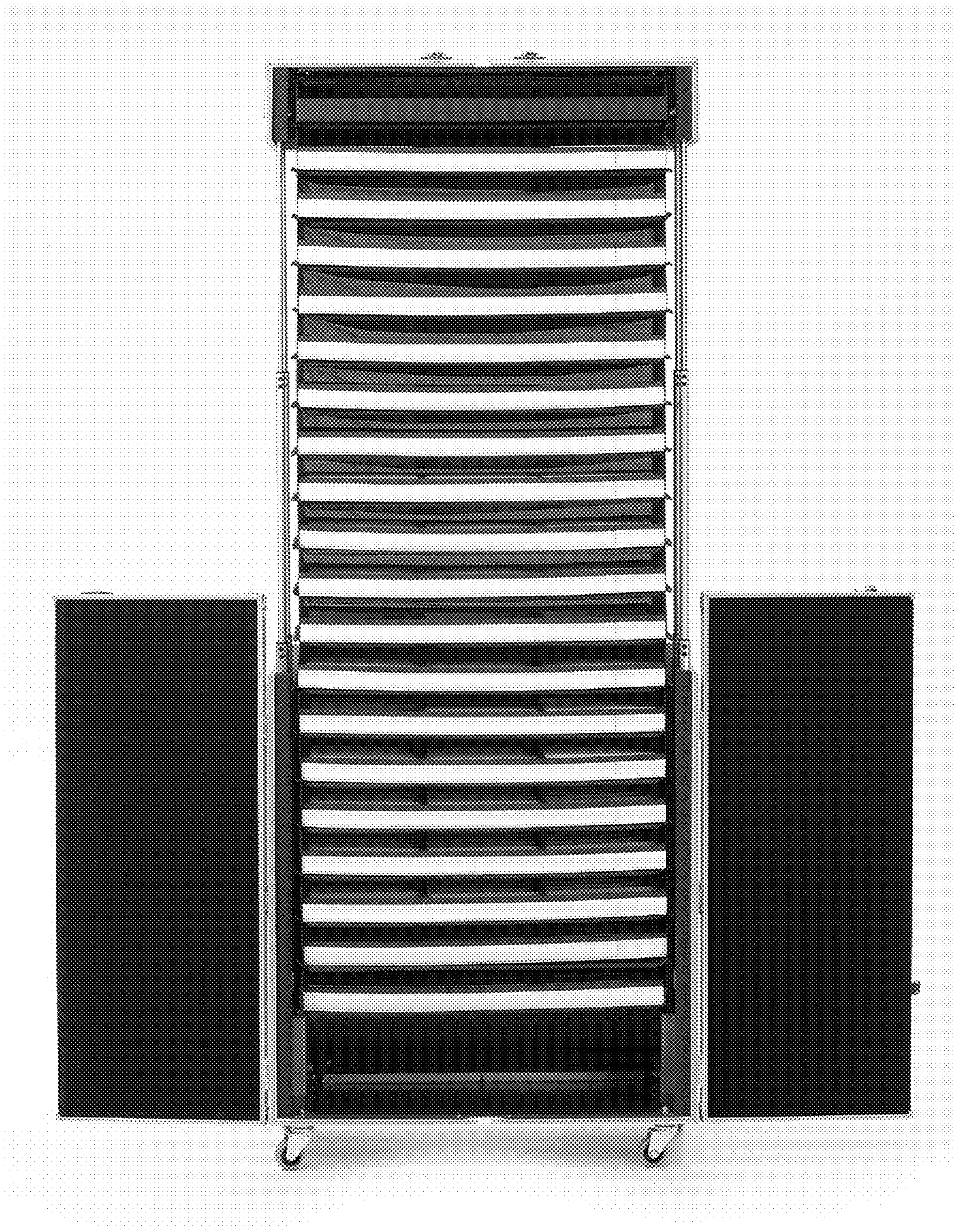

FIG. 18



FIG. 19



FIG. 20



FIG. 21

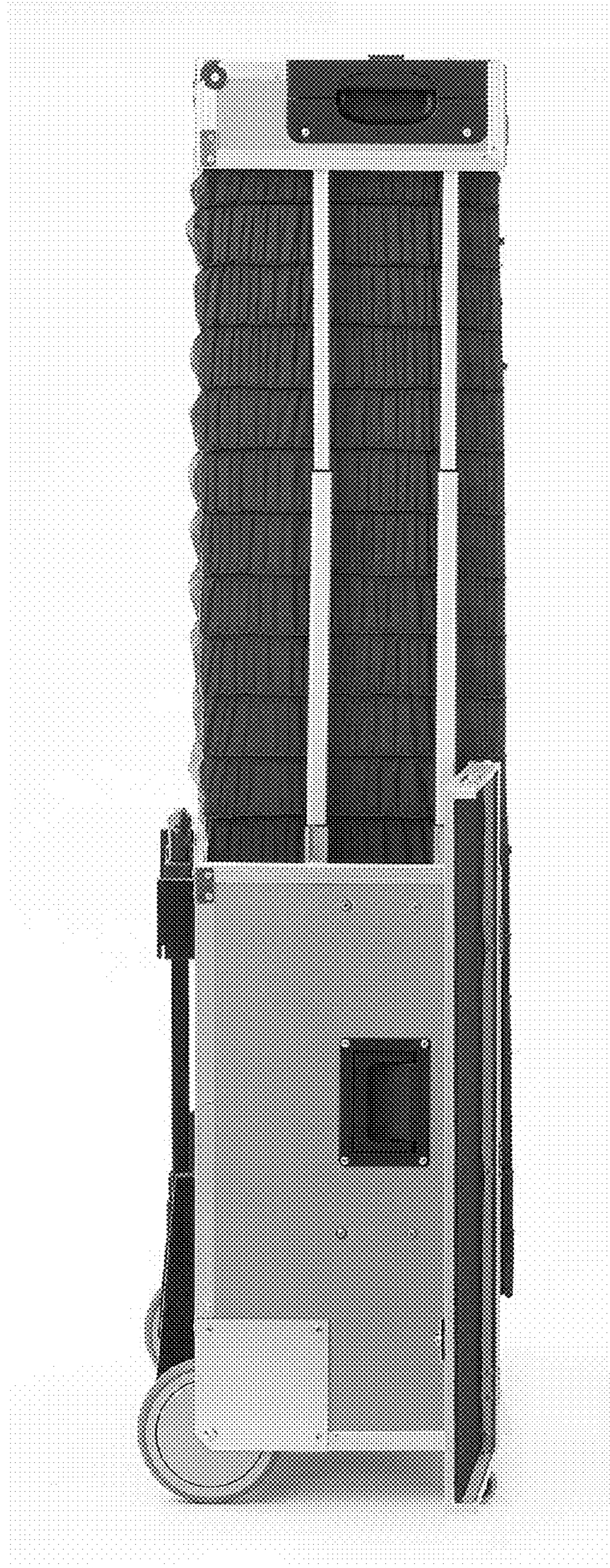

FIG. 22