

US00D640464S

(12) **United States Design Patent**  
**Forthuber et al.**

(10) **Patent No.:** **US D640,464 S**  
(45) **Date of Patent:** **\*\* Jun. 28, 2011**

(54) **UMBRELLA**

(75) Inventors: **Herbert Forthuber**, Simbach (DE);  
**Bernhard Rothbacher**, Salzburg (AT)

(73) Assignee: **doppler E.Doppler & Co. GmbH**,  
Braunau-Ranshofen (AT)

(\*\*) Term: **14 Years**

(21) Appl. No.: **29/315,257**

(22) Filed: **Jun. 9, 2009**

(30) **Foreign Application Priority Data**

Dec. 11, 2008	(EM)	.....	001054779-0001
Dec. 11, 2008	(EM)	.....	001054779-0002
Dec. 11, 2008	(EM)	.....	001054779-0003
Dec. 11, 2008	(EM)	.....	001054779-0004
Dec. 11, 2008	(EM)	.....	001054779-0005

(51) **LOC (9) Cl.** ..... **03-03**

(52) **U.S. Cl.** ..... **D3/5**

(58) **Field of Classification Search** ..... D3/5, 10,  
D3/12, 13, 16, 17; 135/15.1, 23, 20.1, 20.3,  
135/25.31, 33.7, 39, 40, 25.01, 21, 16, 44  
See application file for complete search history.

(56) **References Cited**

**U.S. PATENT DOCUMENTS**

D371,902 S *	7/1996	Lee	.....	D3/5
D398,443 S *	9/1998	Bolle	.....	D3/5
6,418,950 B1 *	7/2002	Tseng	.....	135/28
2008/0105289 A1 *	5/2008	Ma	.....	135/20.3

\* cited by examiner

*Primary Examiner* — Doris Clark

(74) *Attorney, Agent, or Firm* — Collard & Roe, P.C.

(57) **CLAIM**

The ornamental design for an umbrella, as shown and described.

**DESCRIPTION**

FIG. 1 is a front view of an umbrella, showing our new design in an open position;

FIG. 2 is a front view thereof, in a closed position;

FIG. 3 is a side and front view of a detail of the adjustment handle of the umbrella of FIG. 1;

FIG. 4 is a side view of the adjustment handle shown in FIG. 3;

FIG. 5 is an opposite side view of the adjustment handle shown in FIG. 4;

FIG. 6 is a front view of the adjustment handle shown in FIGS. 3-5;

FIG. 7 is a front and side perspective view of the crank handle of the umbrella of FIG. 1;

FIG. 8 is a side view of the crank handle of FIG. 7;

FIG. 9 is an opposite side view of the crank handle of FIG. 8;

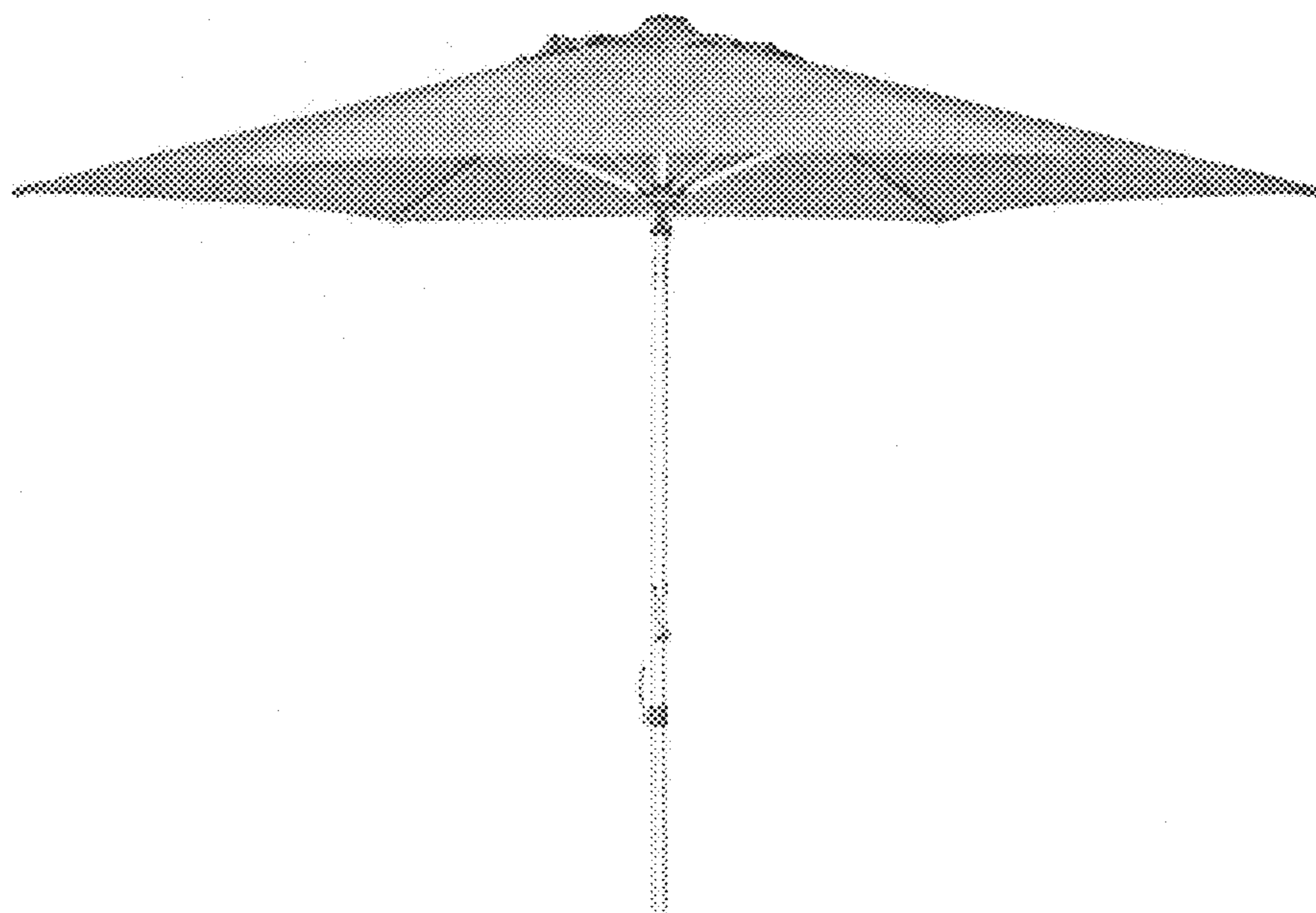
FIG. 10 is a front view of the crank handle of FIGS. 7-9;

FIG. 11 is a top and front perspective view of a detail of the top of the umbrella shown in FIG. 2;

FIG. 12 is a front view of the detail shown in FIG. 11; and,

FIG. 13 is a detail of the spoke mechanism of the umbrella of FIG. 1, in a semi-closed position.

**1 Claim, 13 Drawing Sheets**



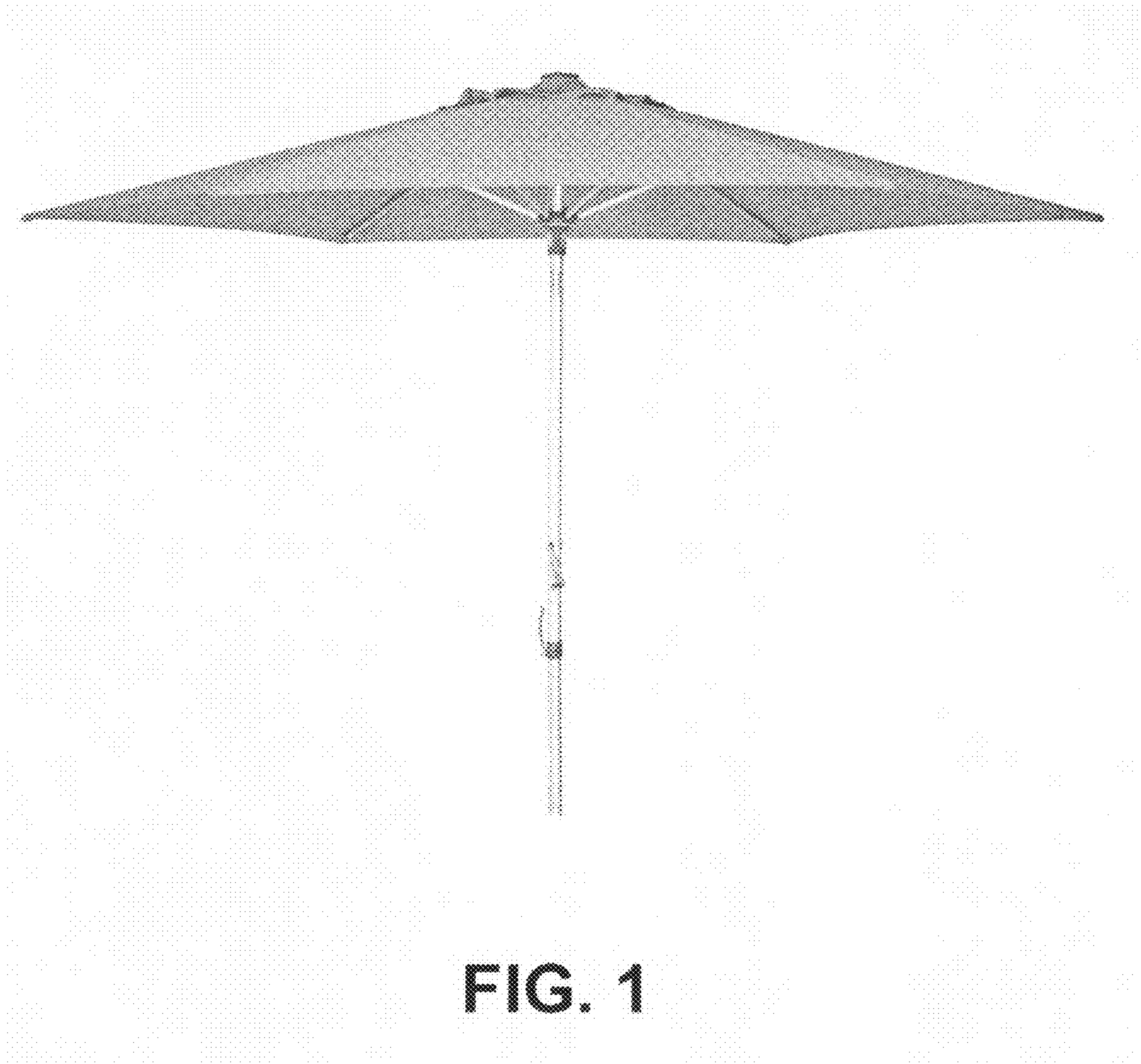
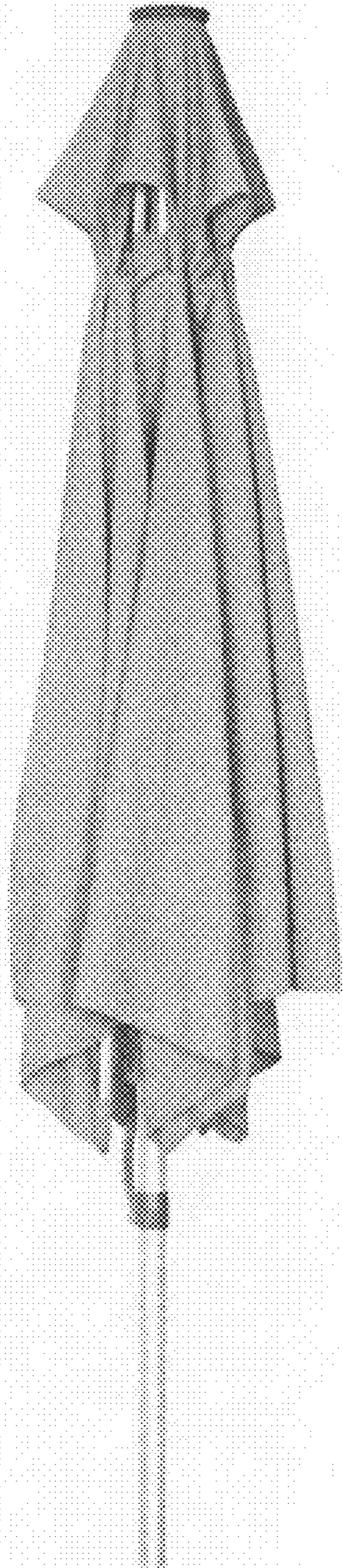
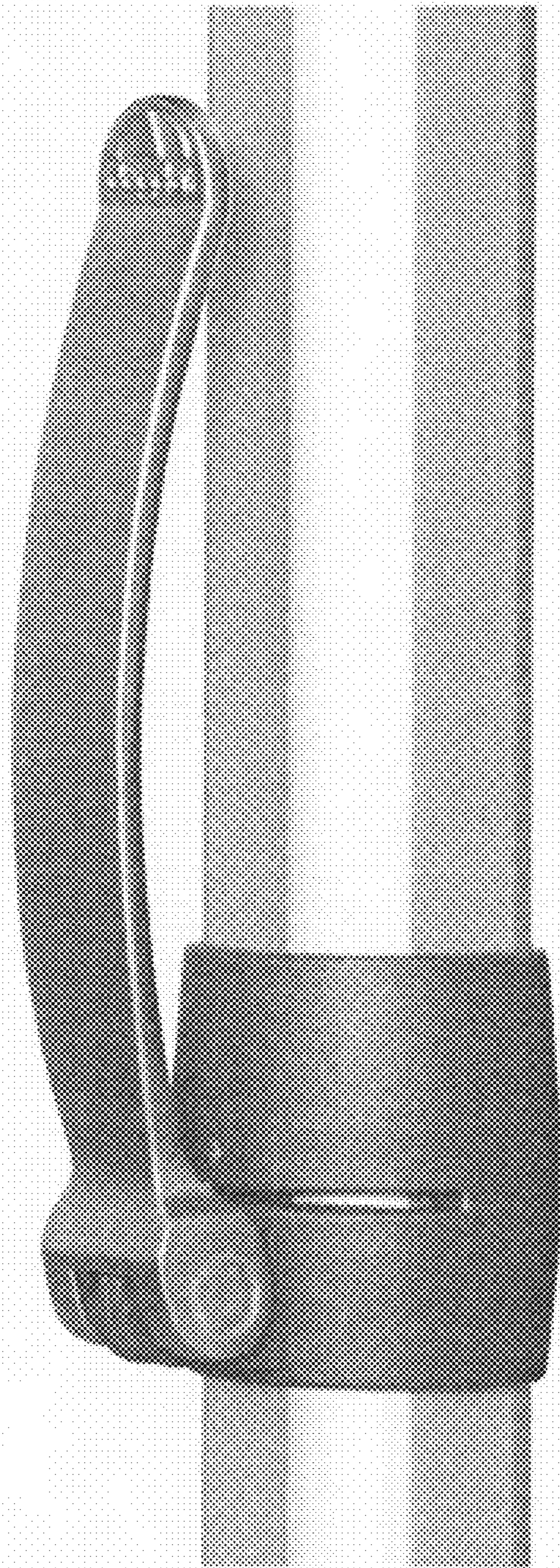


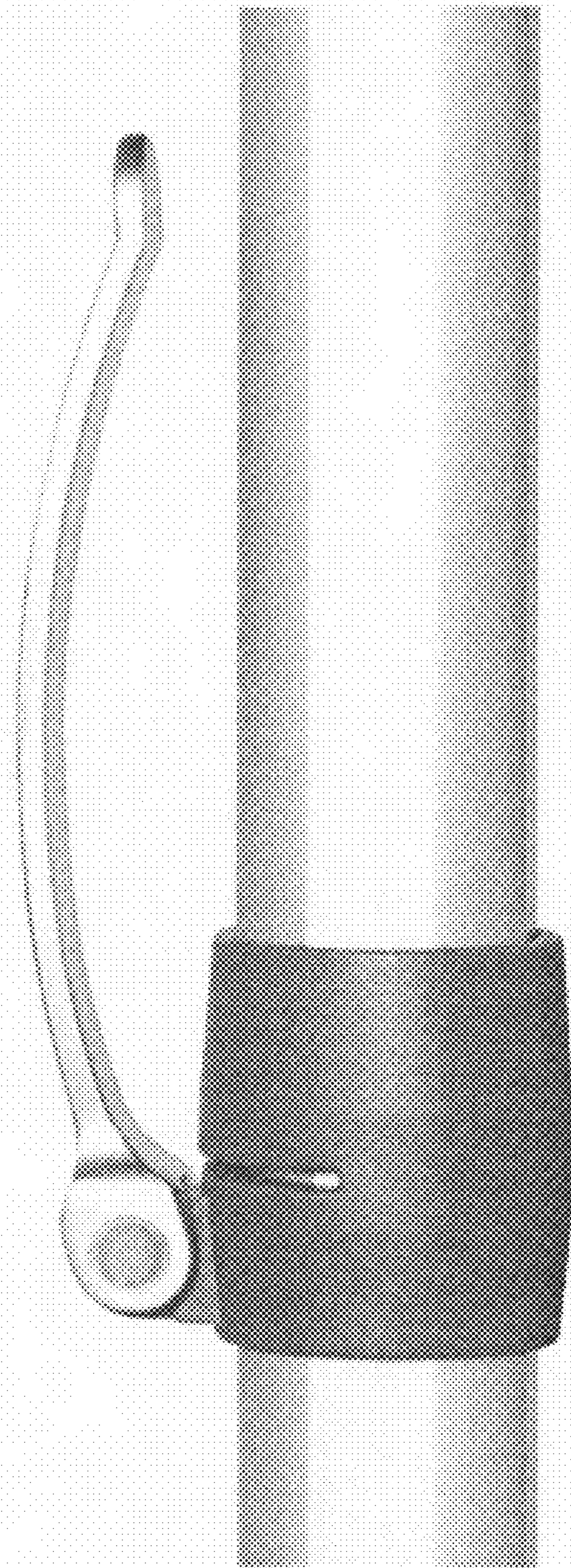
FIG. 1



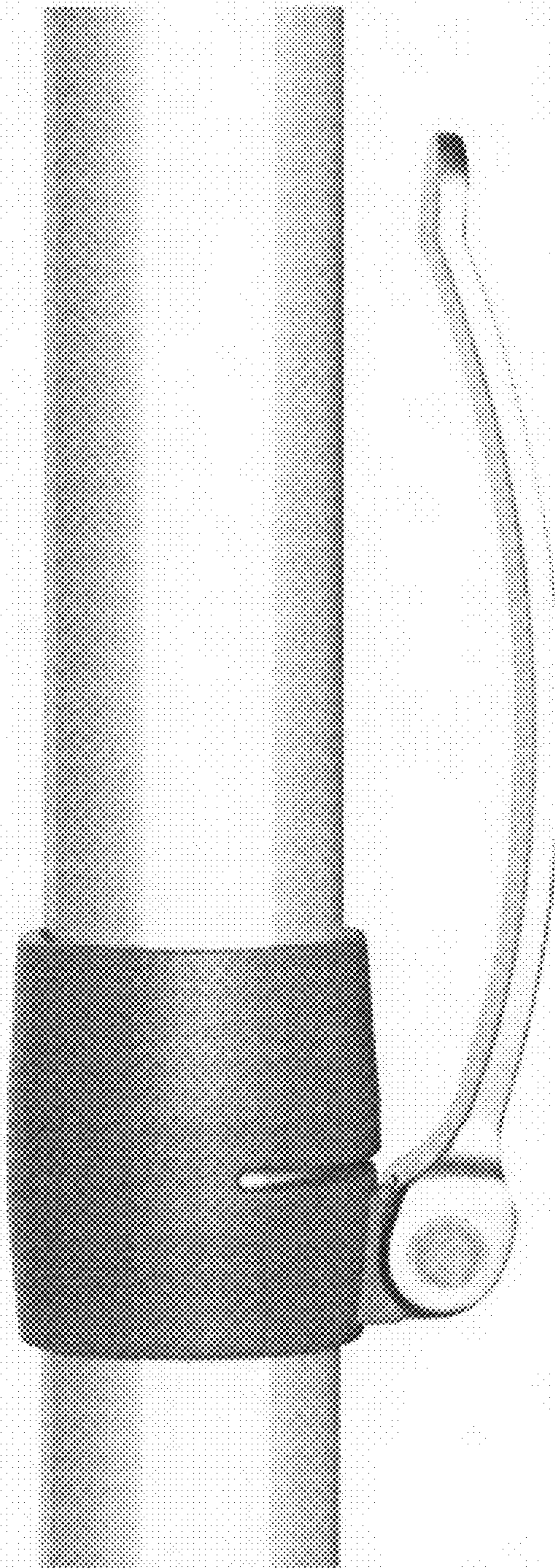
**FIG. 2**



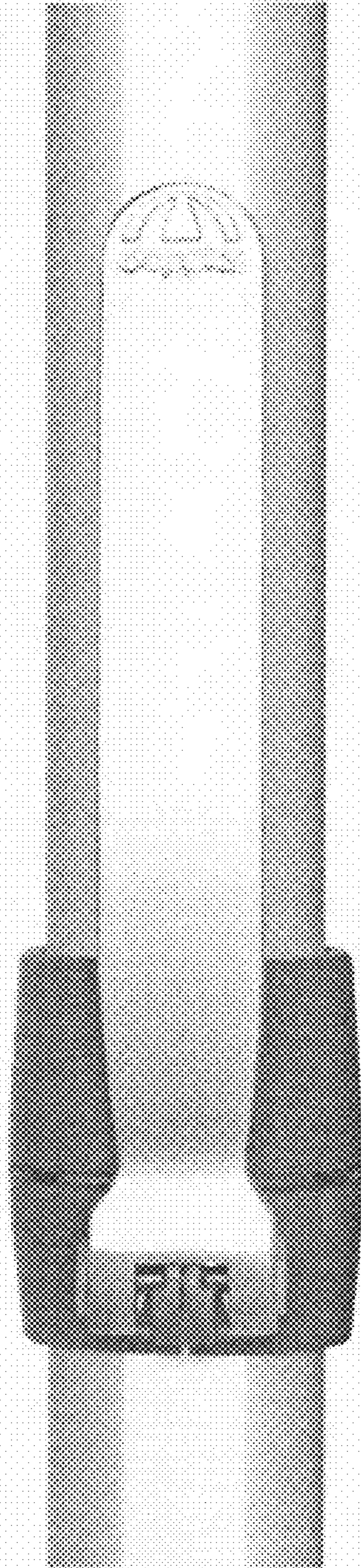
**FIG. 3**



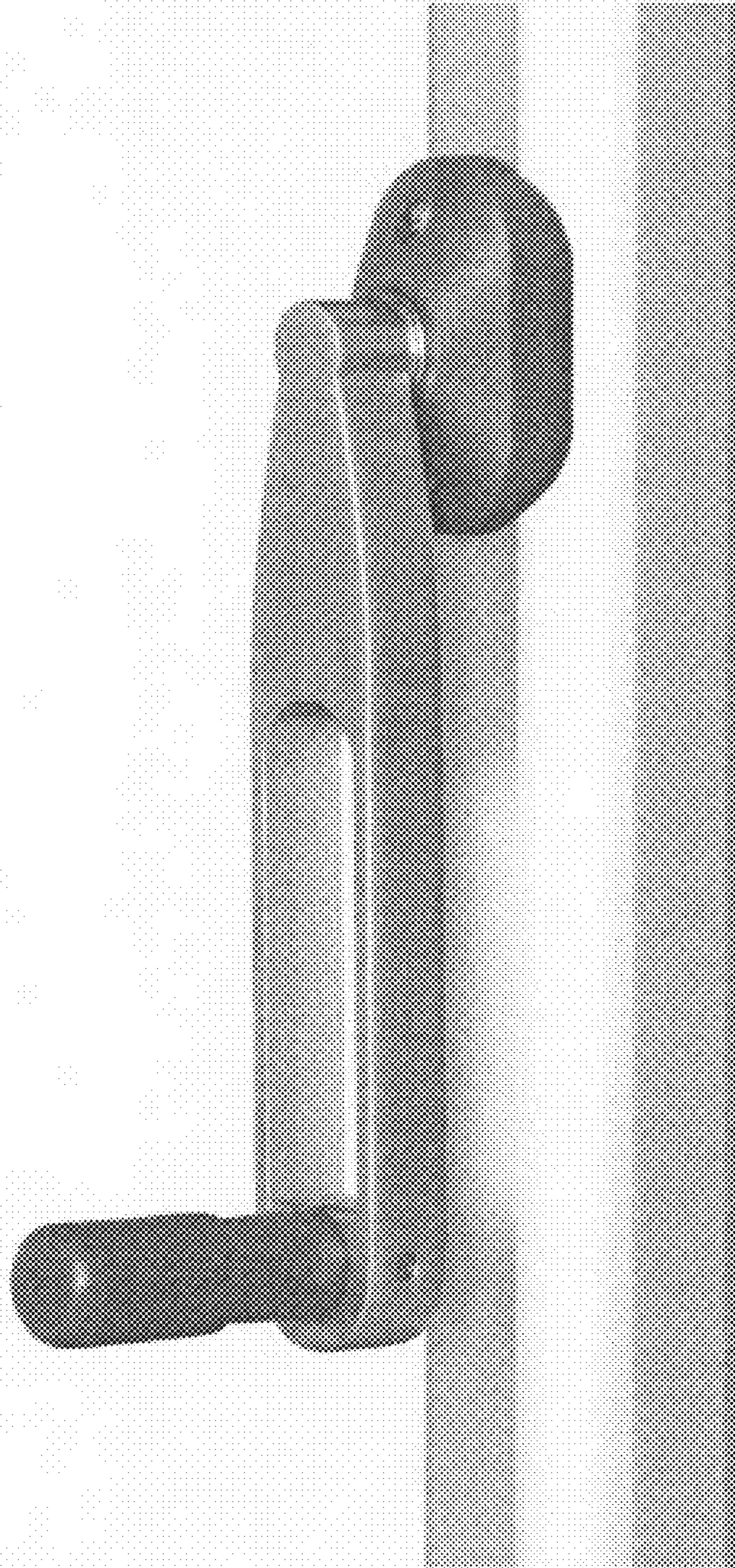
**FIG. 4**



**FIG. 5**

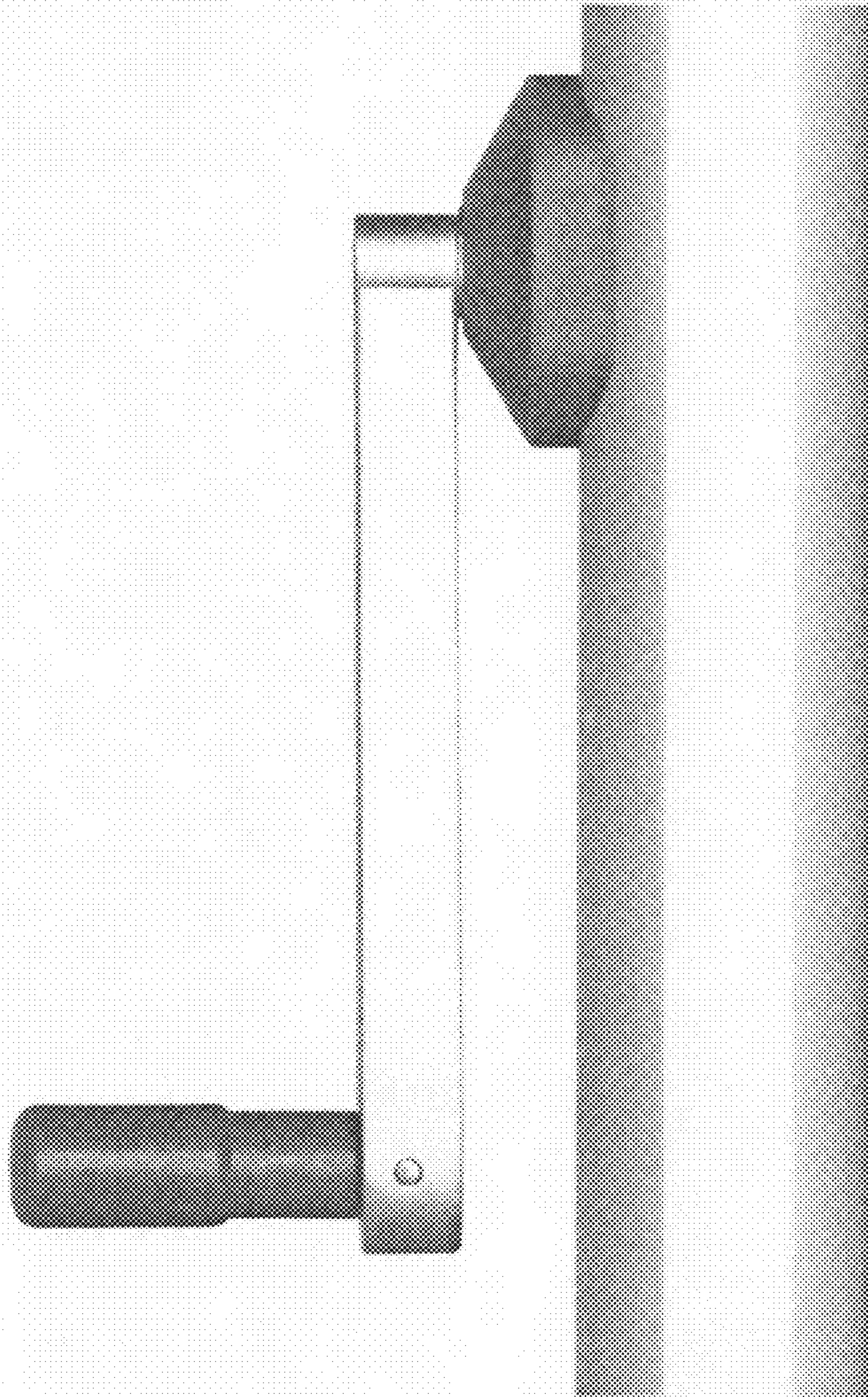


**FIG. 6**

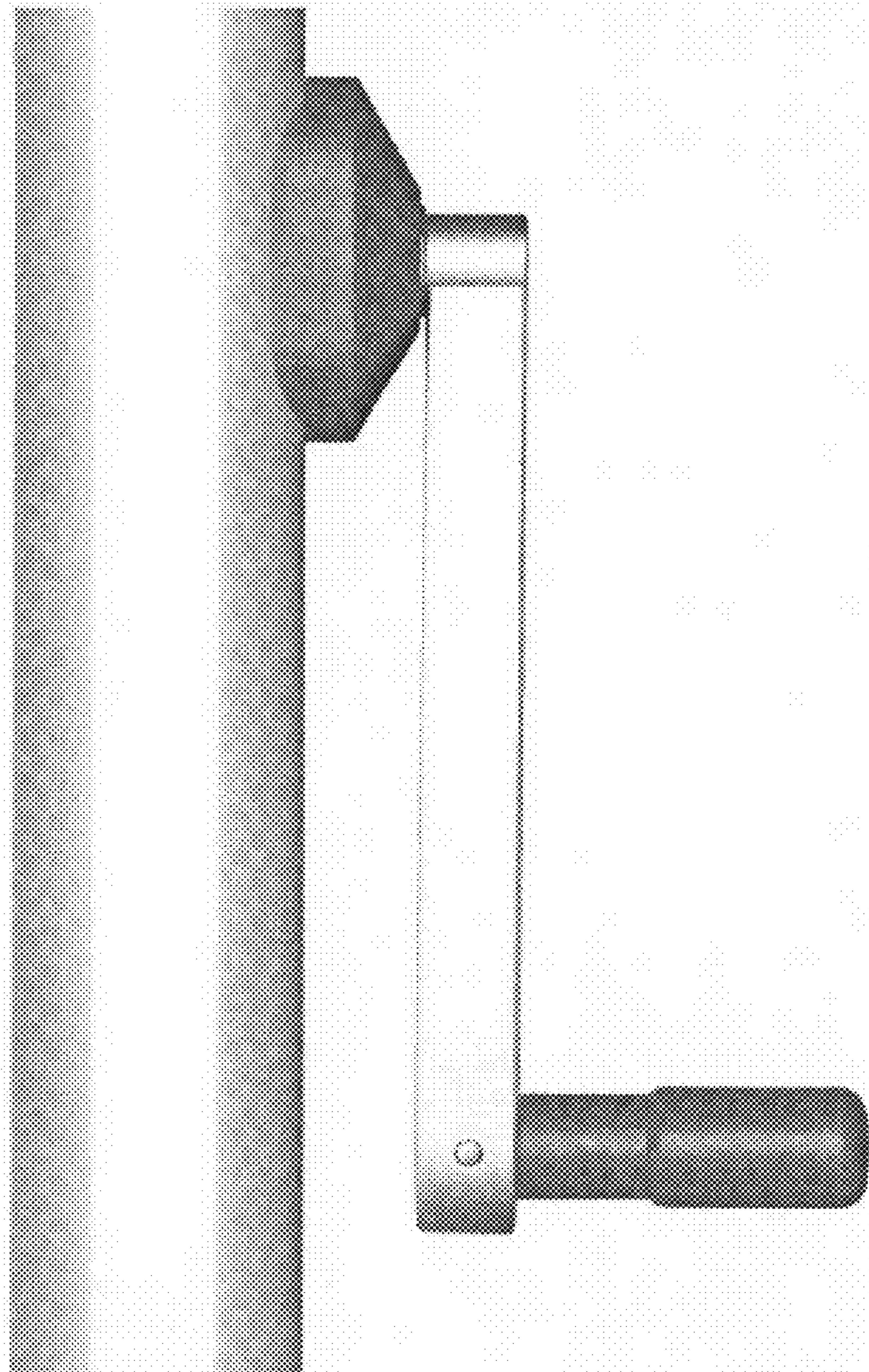


**FIG. 7**

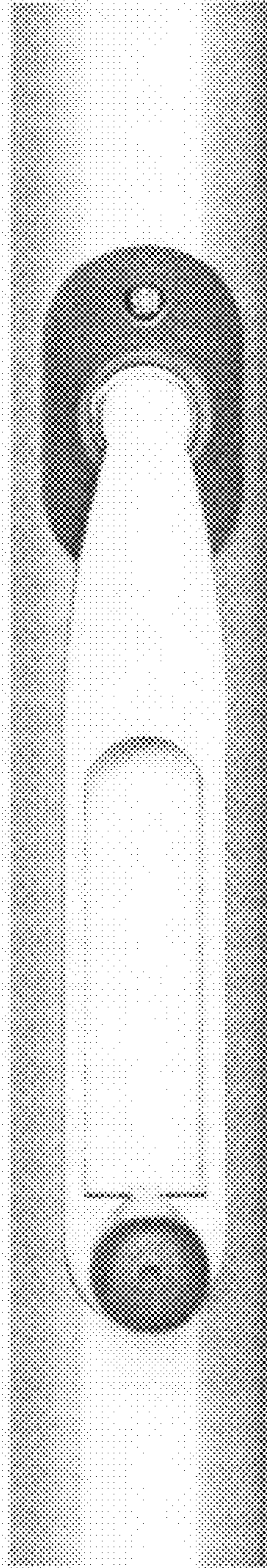




**FIG. 8**



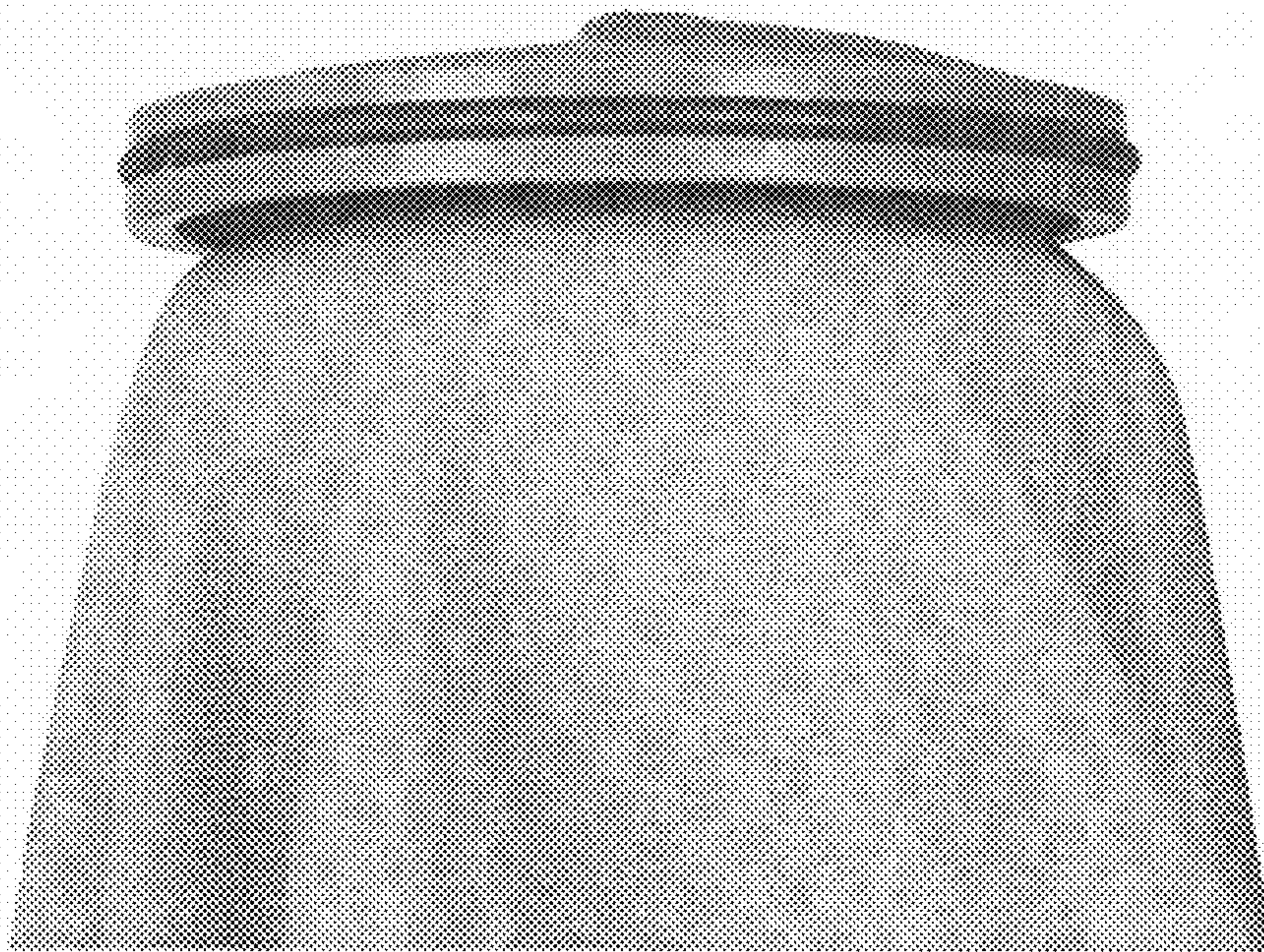
**FIG. 9**



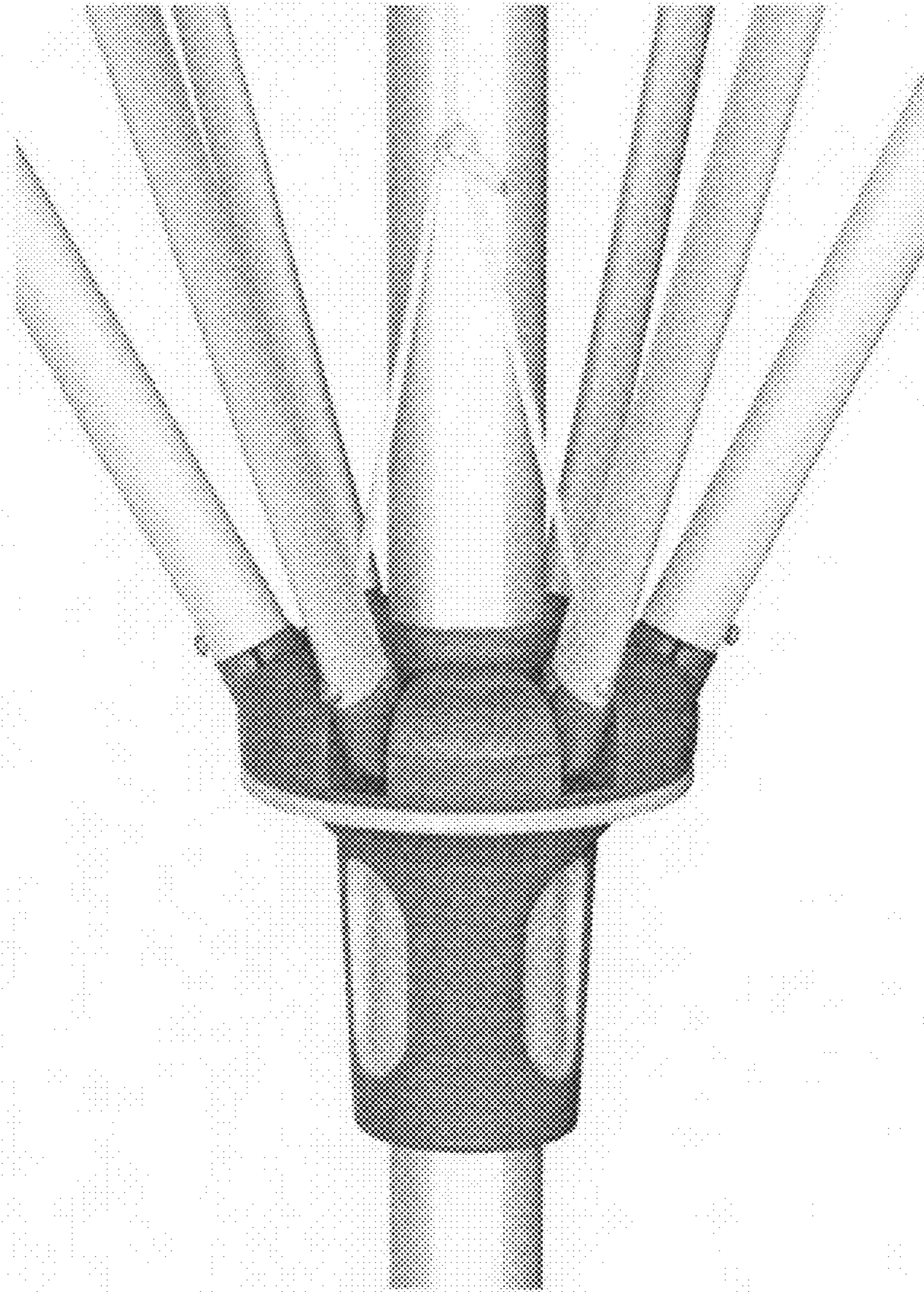
**FIG. 10**



**FIG. 11**



**FIG. 12**



**FIG. 13**