



US00D640421S

(12) **United States Design Patent**
Wright

(10) **Patent No.:** **US D640,421 S**

(45) **Date of Patent:** **** Jun. 21, 2011**

(54) **LENS ASSEMBLY**

(76) **Inventor:** **Jerry Dean Wright, Sherman, TX (US)**

(**) **Term:** **14 Years**

(21) **Appl. No.:** **29/350,789**

(22) **Filed:** **Nov. 23, 2009**

(51) **LOC (9) Cl.** **29-02**

(52) **U.S. Cl.** **D29/122**

(58) **Field of Classification Search** D29/102–106,
D29/108–110, 112, 122; 2/455, 8.1–8.4,
2/8.7, 9, 422–425

See application file for complete search history.

(56) **References Cited**

U.S. PATENT DOCUMENTS

D264,891 S *	6/1982	Rosenius	D29/110
D518,242 S *	3/2006	Wright et al.	D29/108
D522,179 S *	5/2006	Wright et al.	D29/108
D526,094 S *	8/2006	Chen	D29/108
D526,097 S *	8/2006	Lilenthal et al.	D29/122
D539,988 S *	4/2007	Crafoord et al.	D29/122
D555,290 S *	11/2007	Wright et al.	D29/108
D557,460 S *	12/2007	Jourde et al.	D29/108
D558,403 S *	12/2007	Lee et al.	D29/108
D569,557 S *	5/2008	Cho	D29/122

D584,009 S *	12/2008	Juhlin	D29/122
D586,051 S *	2/2009	Martin et al.	D29/110
D624,705 S *	9/2010	Wright	D29/108
2007/0192946 A1 *	8/2007	Wright	2/424
2007/0220649 A1 *	9/2007	Huh	2/9

* cited by examiner

Primary Examiner — Ruth McInroy

(74) *Attorney, Agent, or Firm* — Stephen C. Beuerle;
Procopio Cory Hargreaves & Savitch LLP

(57) **CLAIM**

The ornamental design for a lens assembly, as shown and described.

DESCRIPTION

FIG. 1 is a front perspective view of a lens assembly showing my new design;
FIG. 2 is a rear perspective view thereof;
FIG. 3 is a bottom plan view thereof;
FIG. 4 is a top plan view thereof;
FIG. 5 is a rear elevational view thereof;
FIG. 6 is a right side elevational view thereof, the left side being a mirror image; and,
FIG. 7 is a front elevational view thereof.

1 Claim, 7 Drawing Sheets

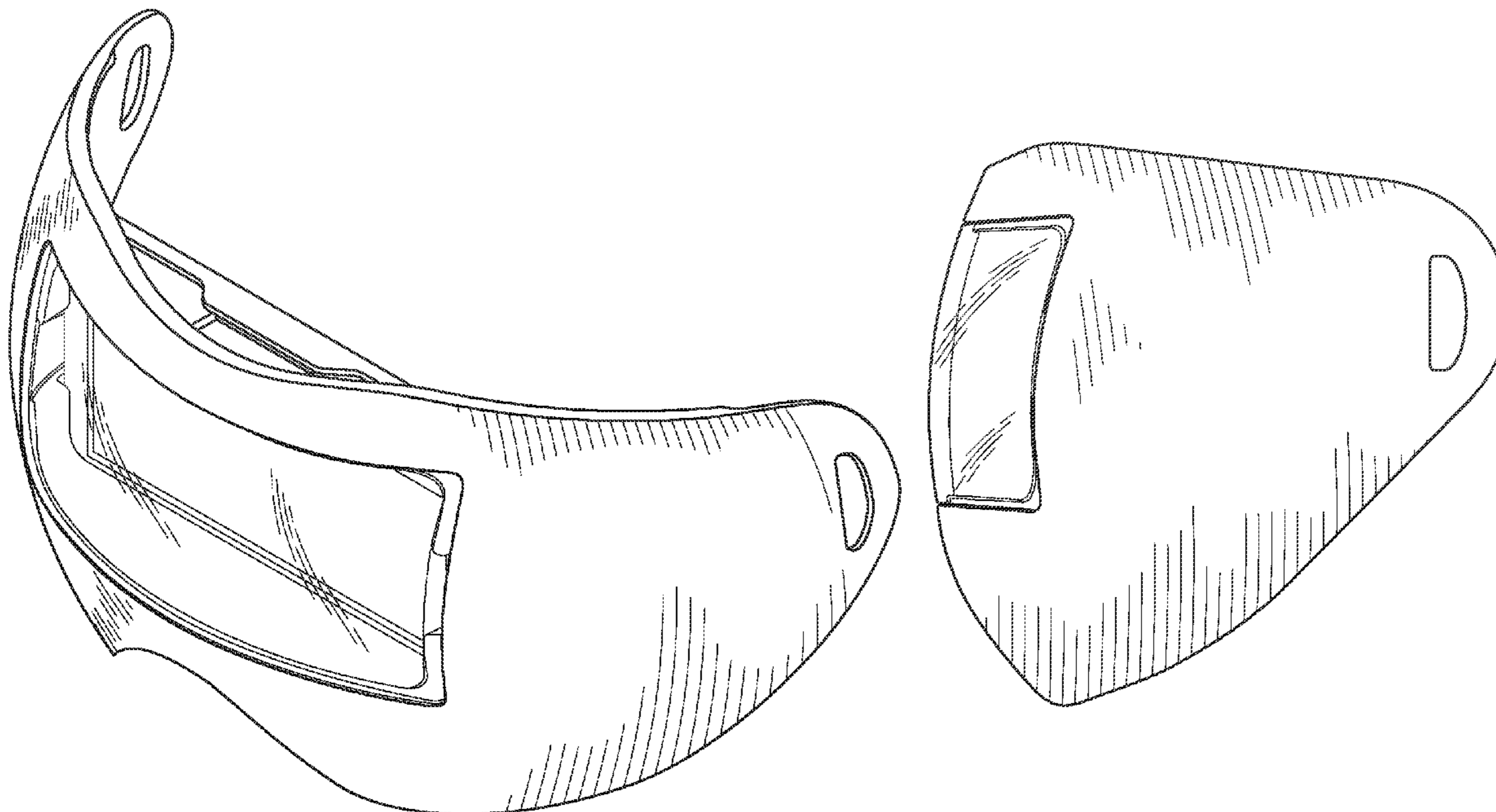

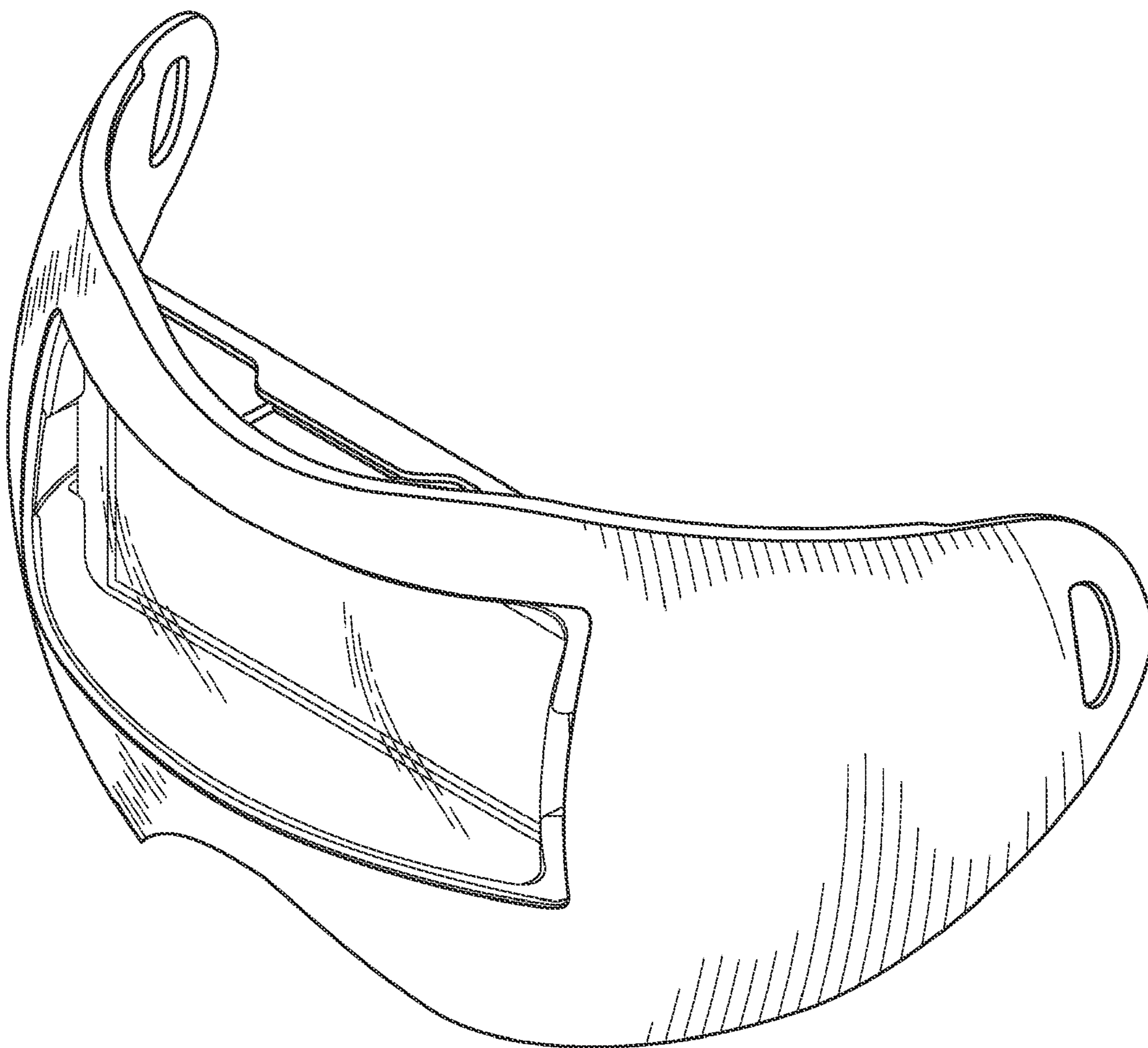

FIG. 1

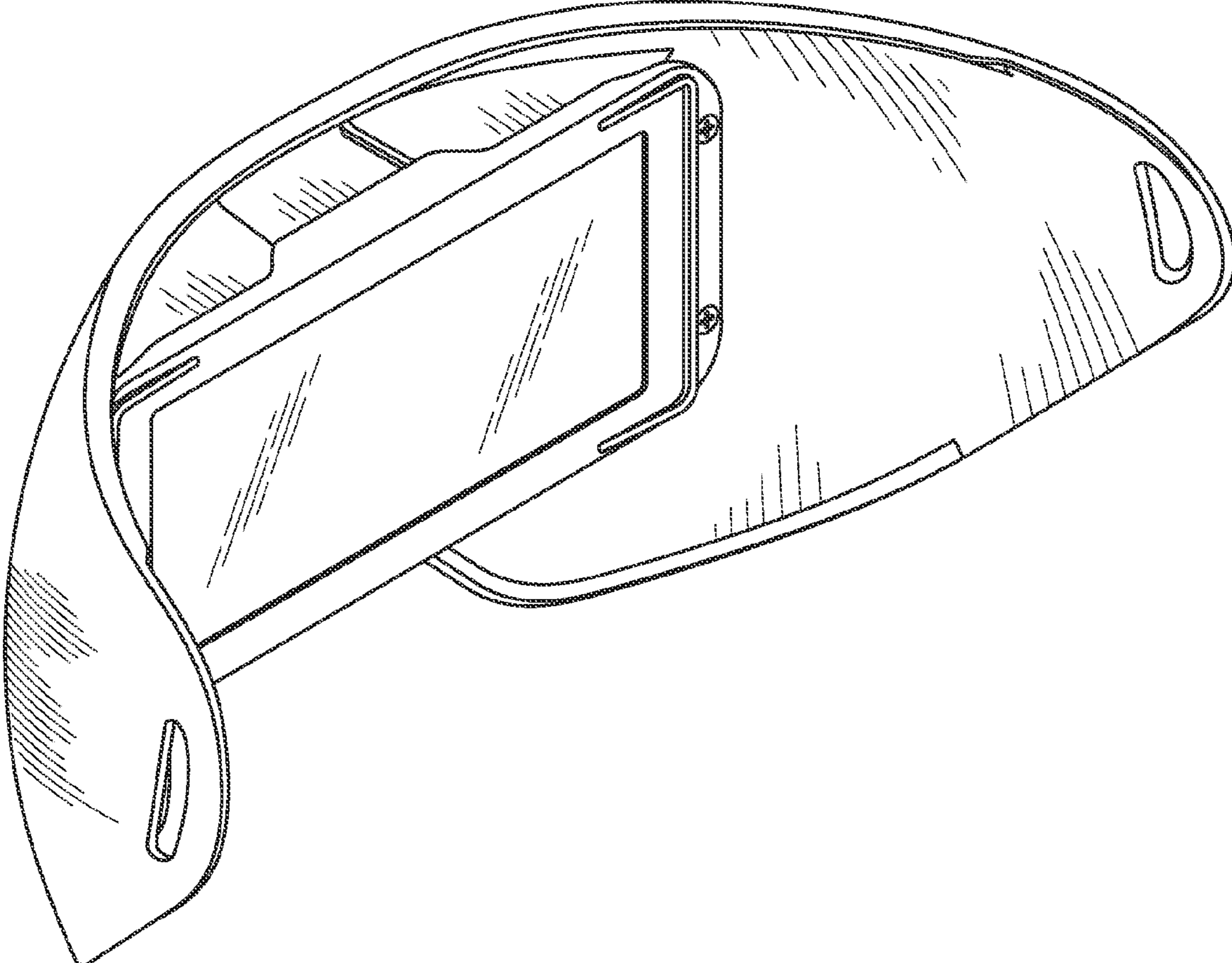

FIG. 2

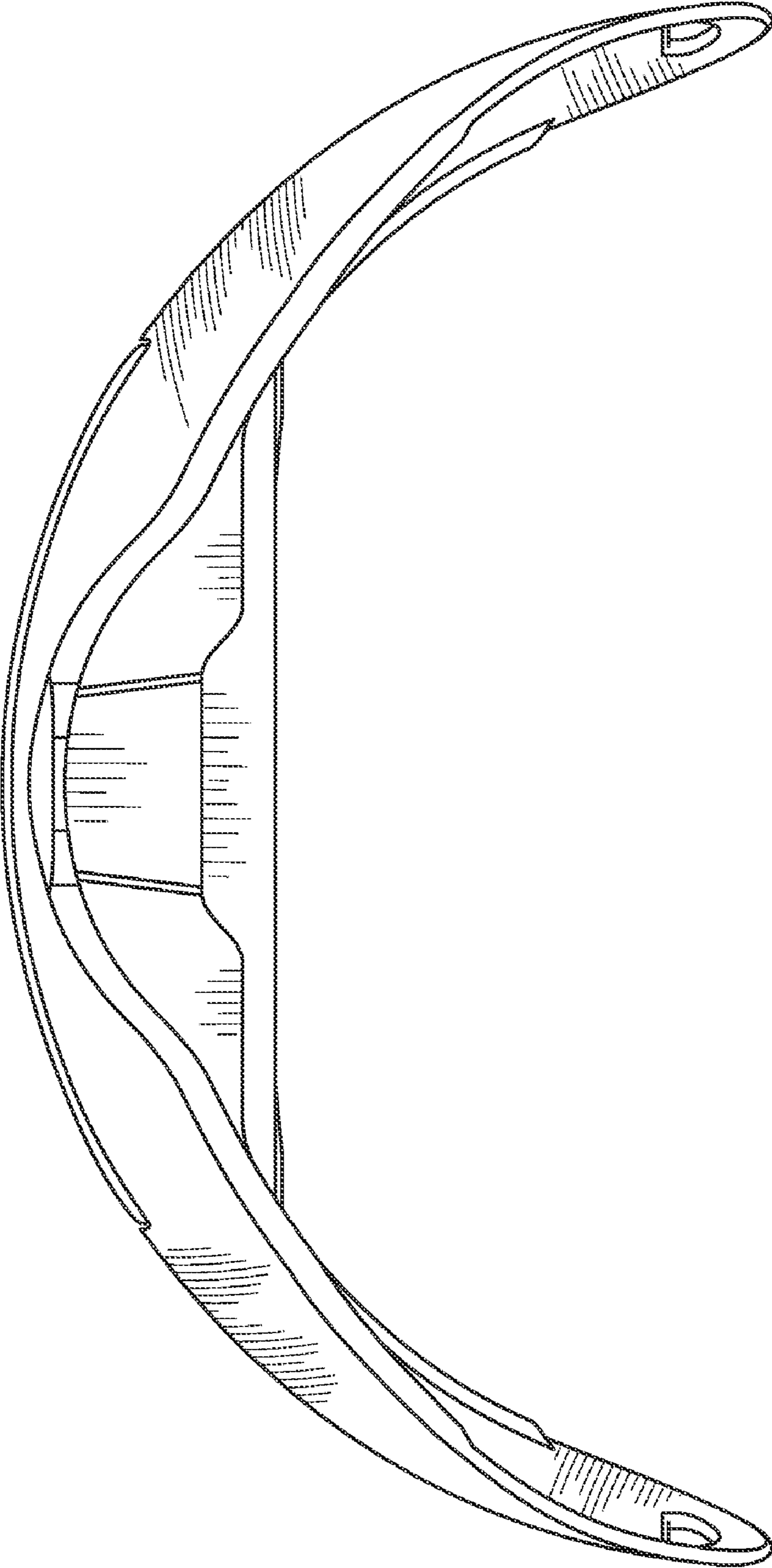

FIG. 3

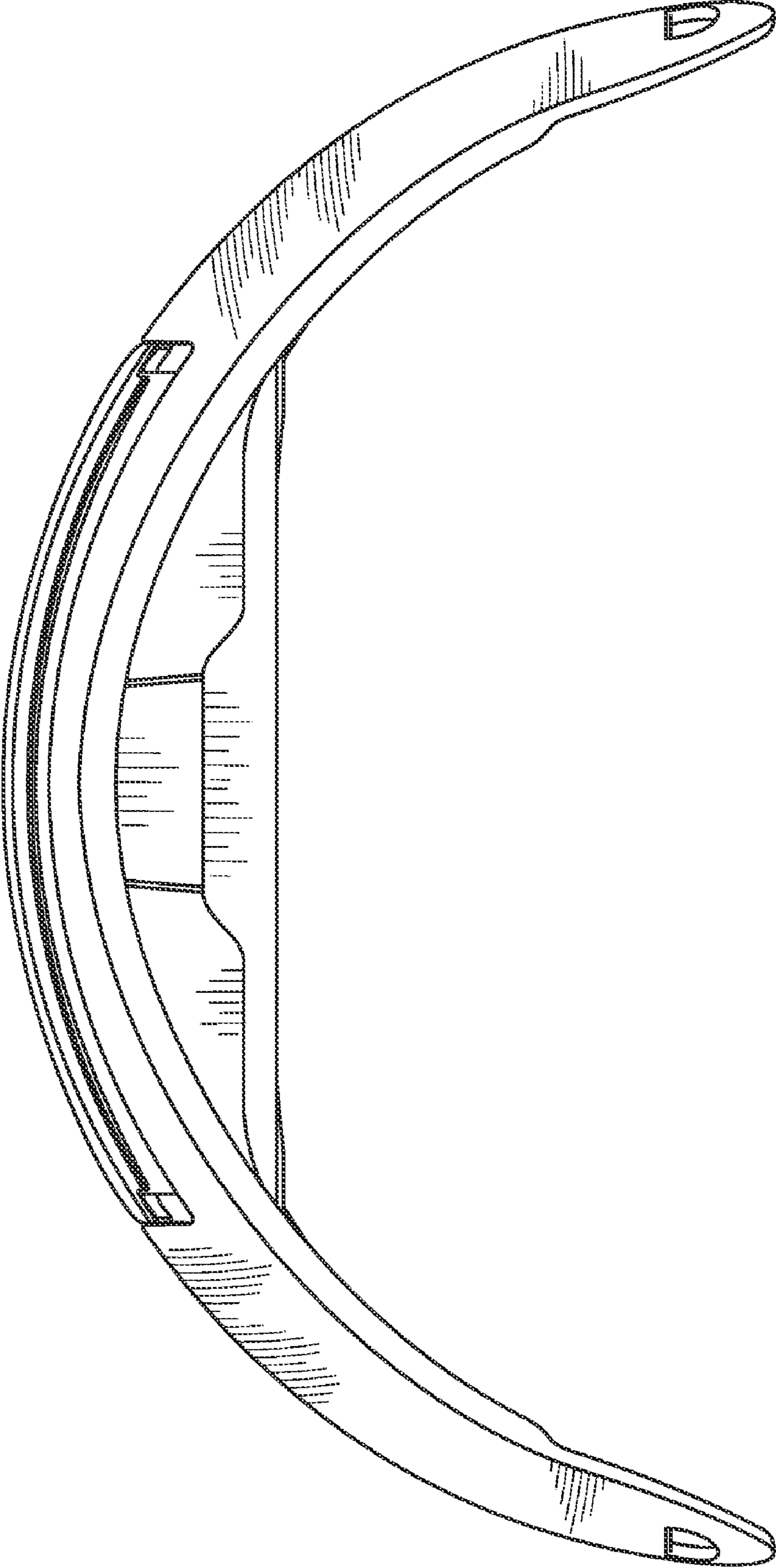

FIG. 4

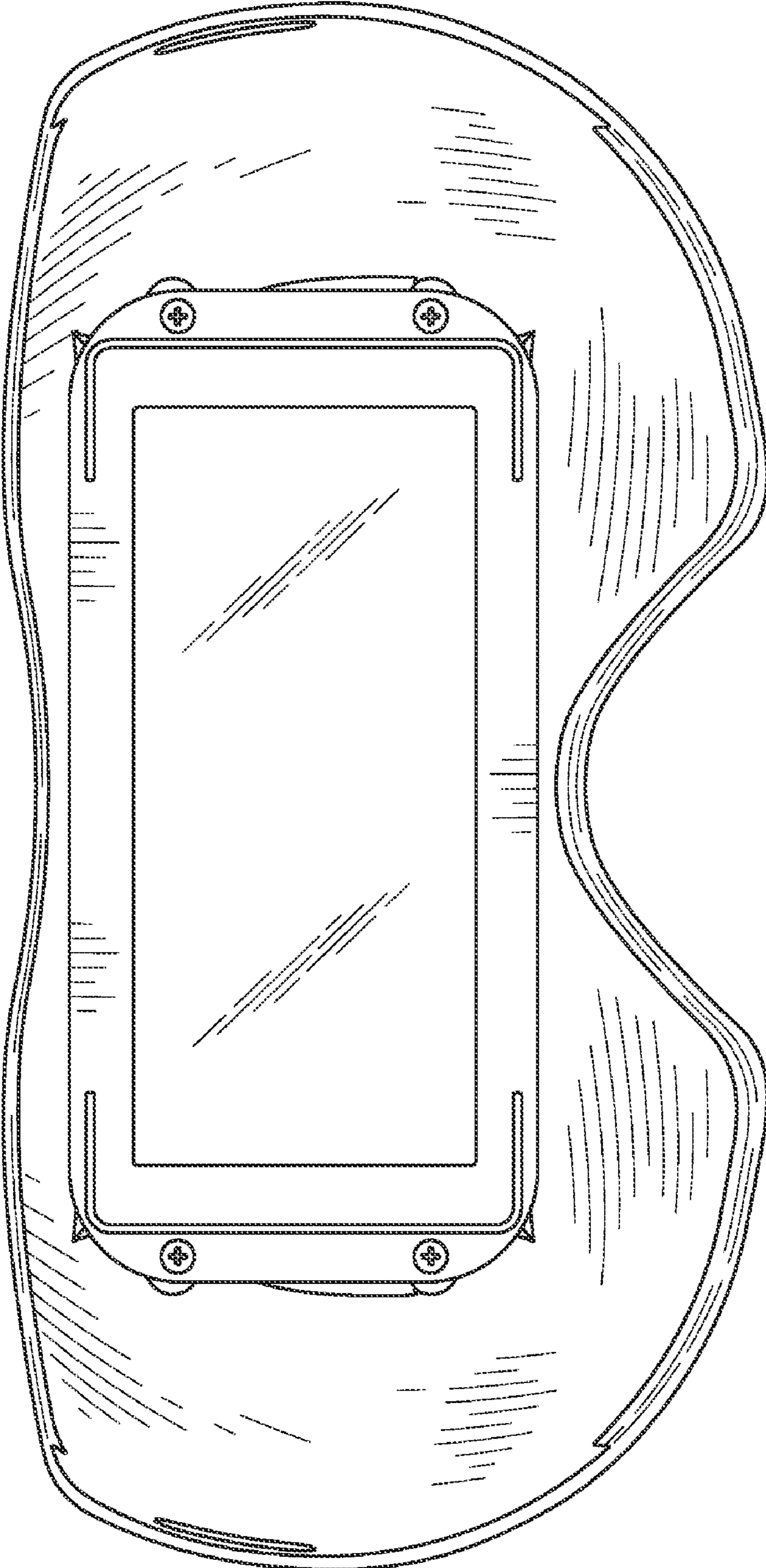

FIG. 5

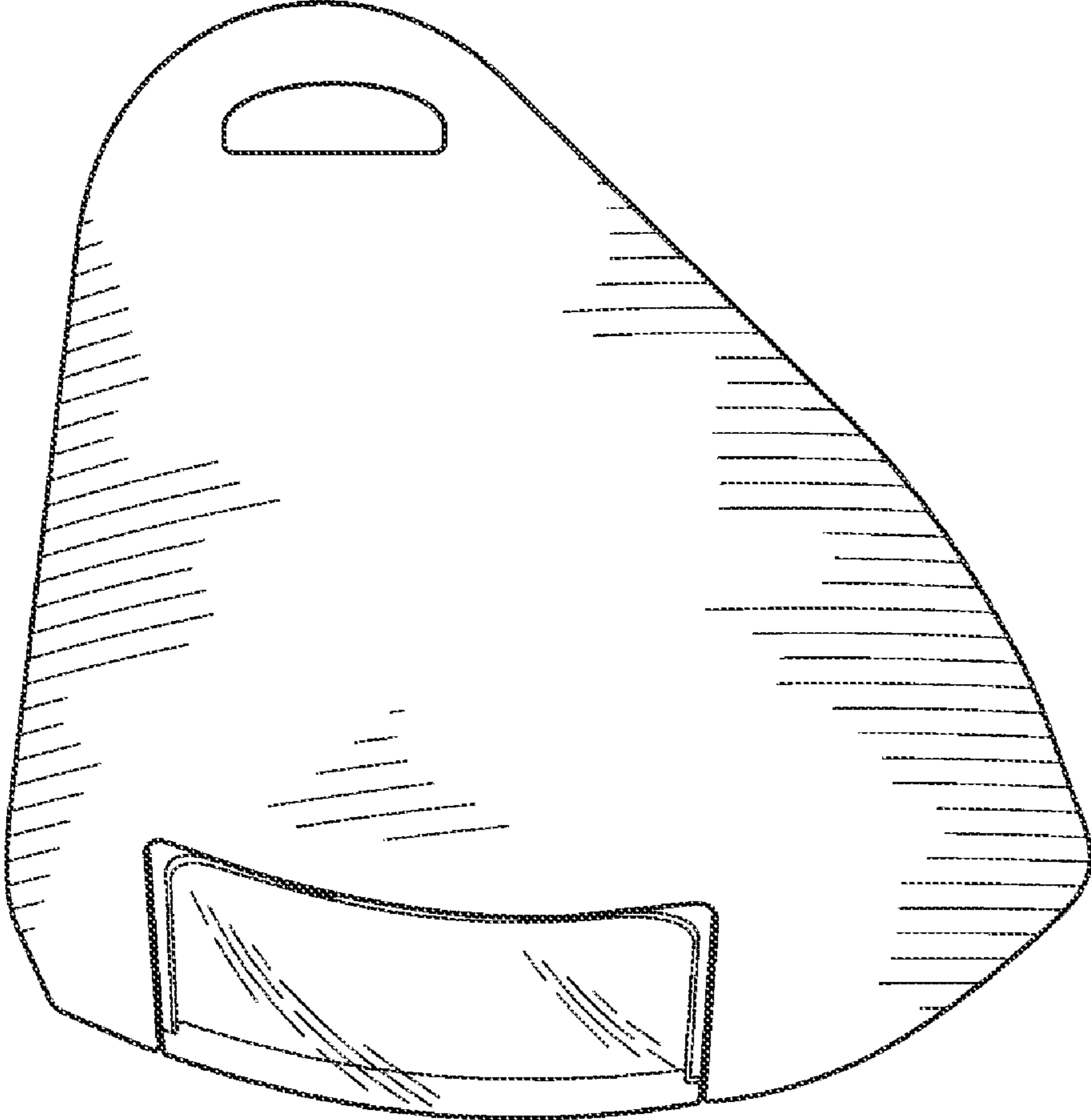

FIG. 6

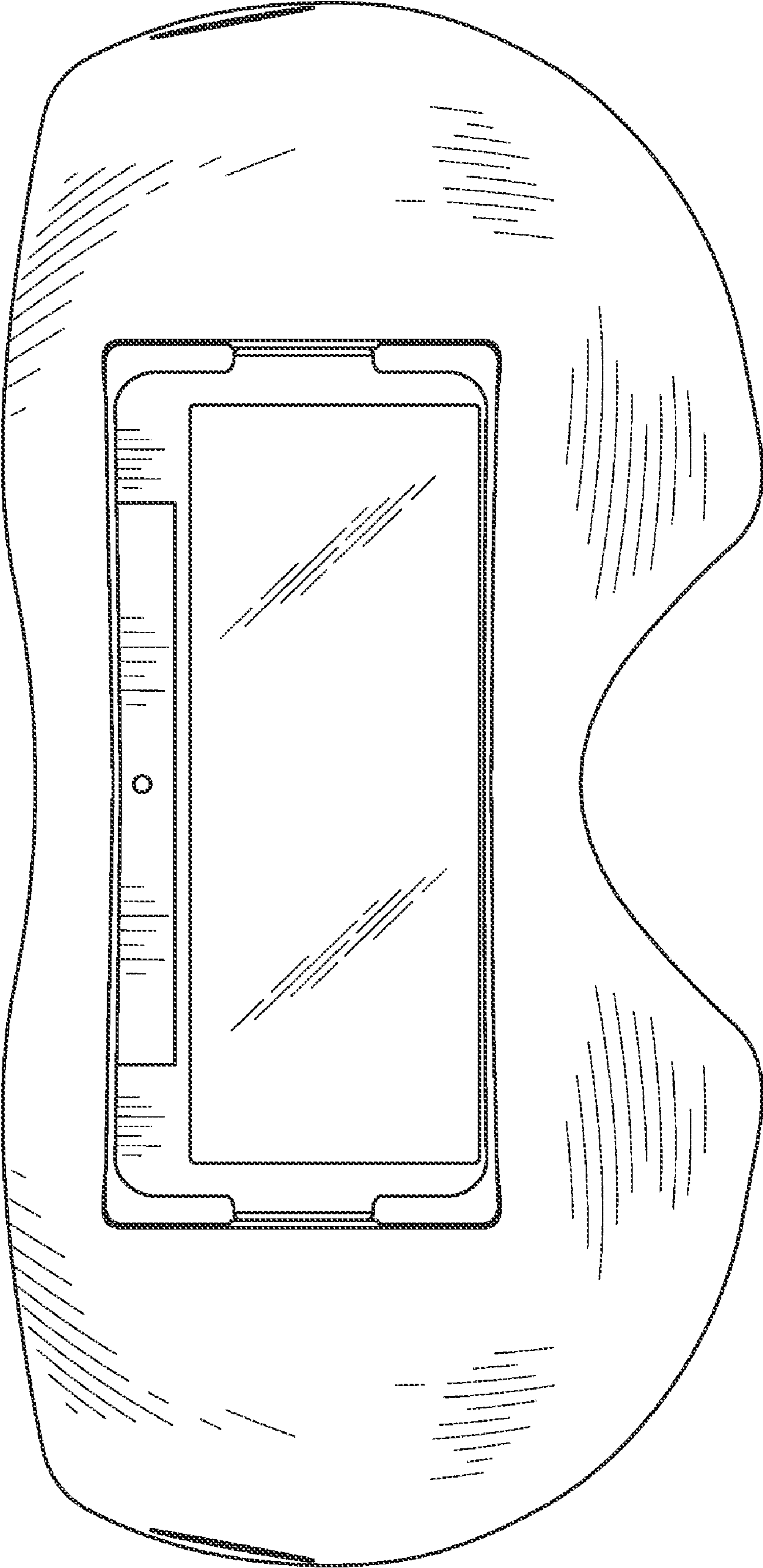

FIG. 7