



US00D640419S

(12) **United States Design Patent**
Wright

(10) **Patent No.:** **US D640,419 S**

(45) **Date of Patent:** **** *Jun. 21, 2011**

(54) **COMBINED FACE PROTECTOR AND LENS ASSEMBLY**

(76) Inventor: **Jerry Dean Wright**, Sherman, TX (US)

(*) Notice: This patent is subject to a terminal disclaimer.

(**) Term: **14 Years**

(21) Appl. No.: **29/355,232**

(22) Filed: **Feb. 4, 2010**

(51) **LOC (9) Cl.** **29-02**

(52) **U.S. Cl.** **D29/110**

(58) **Field of Classification Search** D29/102-106,
D29/108, 110, 112, 122, 109; 2/455, 8.1-8.4,
2/8.7, 9, 410, 422-425

See application file for complete search history.

(56) **References Cited**

U.S. PATENT DOCUMENTS

D518,242 S *	3/2006	Wright et al.	D29/108
D522,179 S *	5/2006	Wright et al.	D29/108
D526,094 S *	8/2006	Chen	D29/108
D555,290 S *	11/2007	Wright et al.	D29/108
D557,460 S *	12/2007	Jourde et al.	D29/108

D558,403 S *	12/2007	Lee et al.	D29/108
D586,051 S *	2/2009	Martin et al.	D29/110
D624,705 S *	9/2010	Wright	D29/108
2007/0192946 A1 *	8/2007	Wright	2/424
2007/0220649 A1 *	9/2007	Huh	2/9

* cited by examiner

Primary Examiner — Ruth McInroy

(74) *Attorney, Agent, or Firm* — Stephen C. Beuerle; Procopio Cory Hargreaves & Savitch LLP

(57) **CLAIM**

The ornamental design for a combined face protector and lens assembly, as shown and described.

DESCRIPTION

FIG. 1 is a front perspective view of a combined face protector and lens assembly showing my new design; FIG. 2 is a rear perspective view thereof; FIG. 3 is a bottom plan view thereof; FIG. 4 is a top plan view thereof; FIG. 5 is a rear elevational view thereof; FIG. 6 is a right side elevational view thereof, the left side being a mirror image; and, FIG. 7 is a front elevational view thereof.

1 Claim, 7 Drawing Sheets

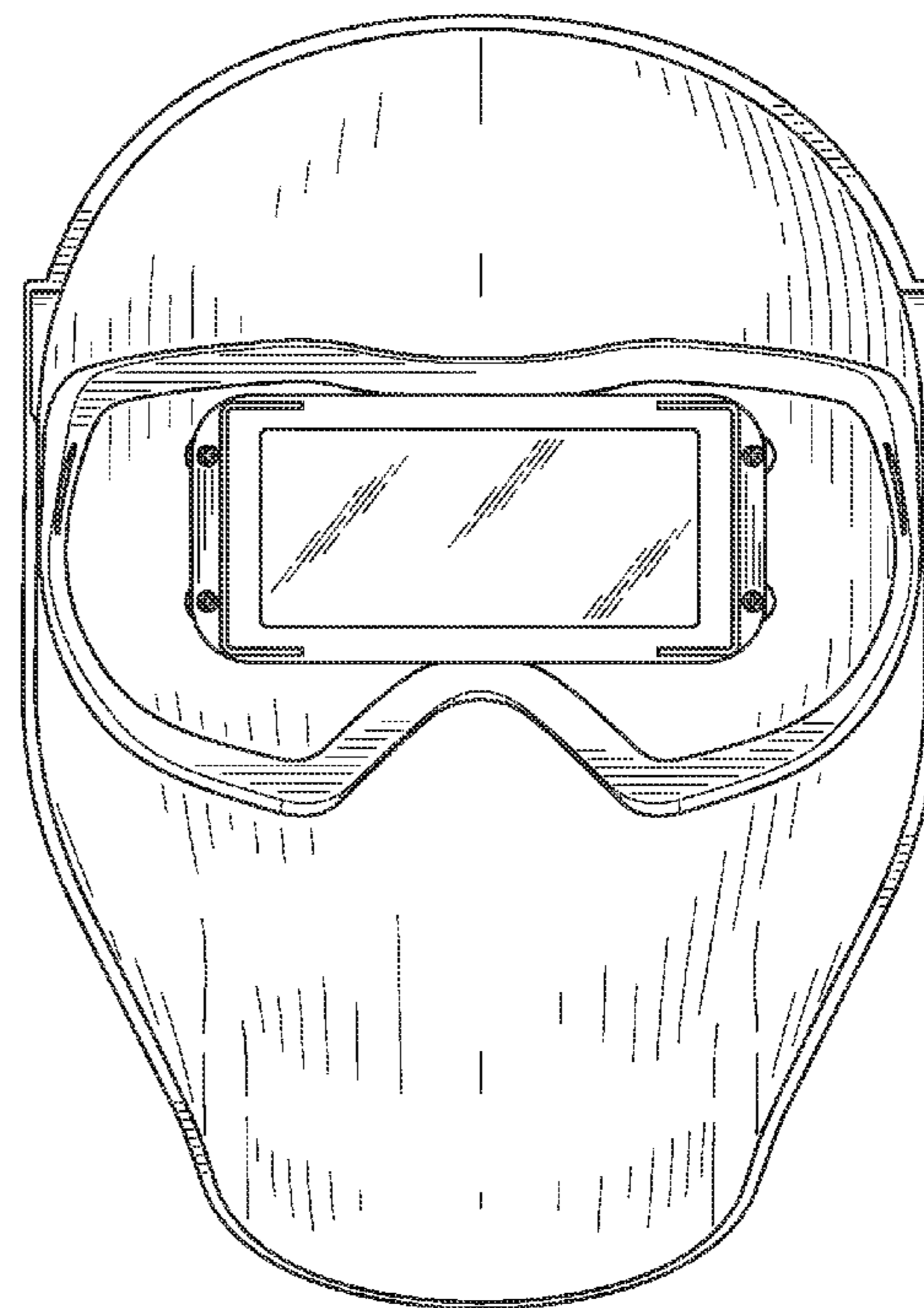
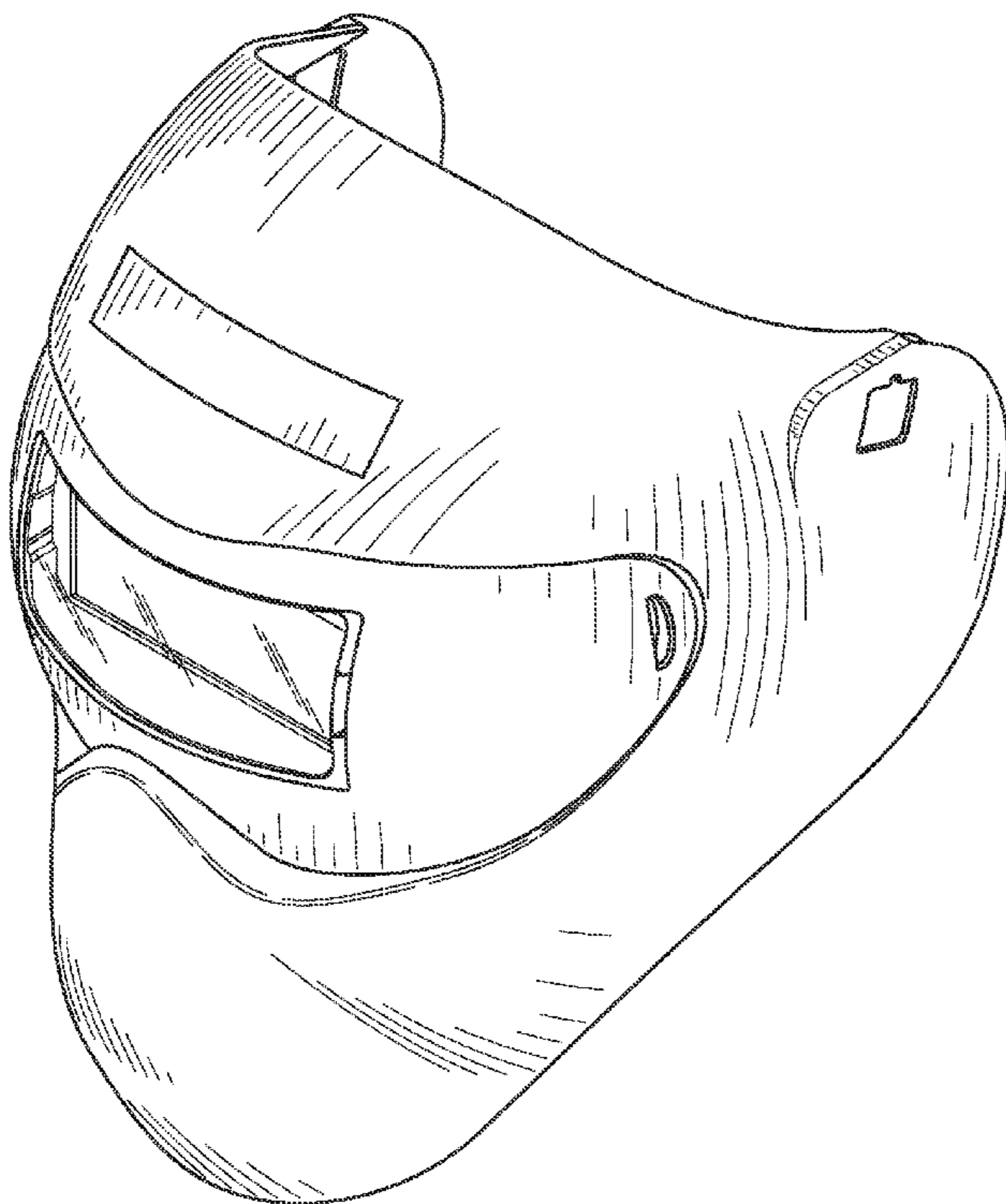

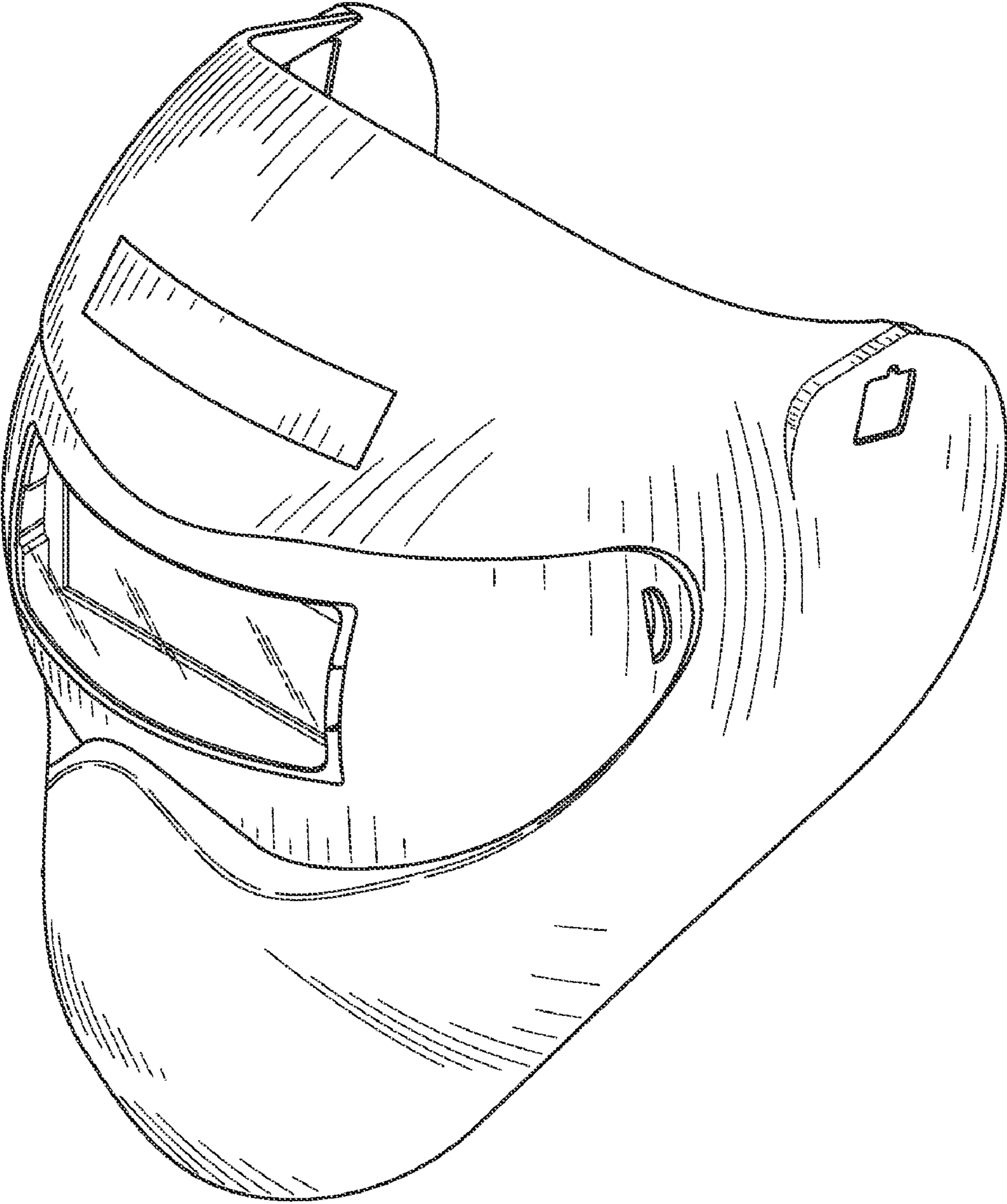

FIG. 1

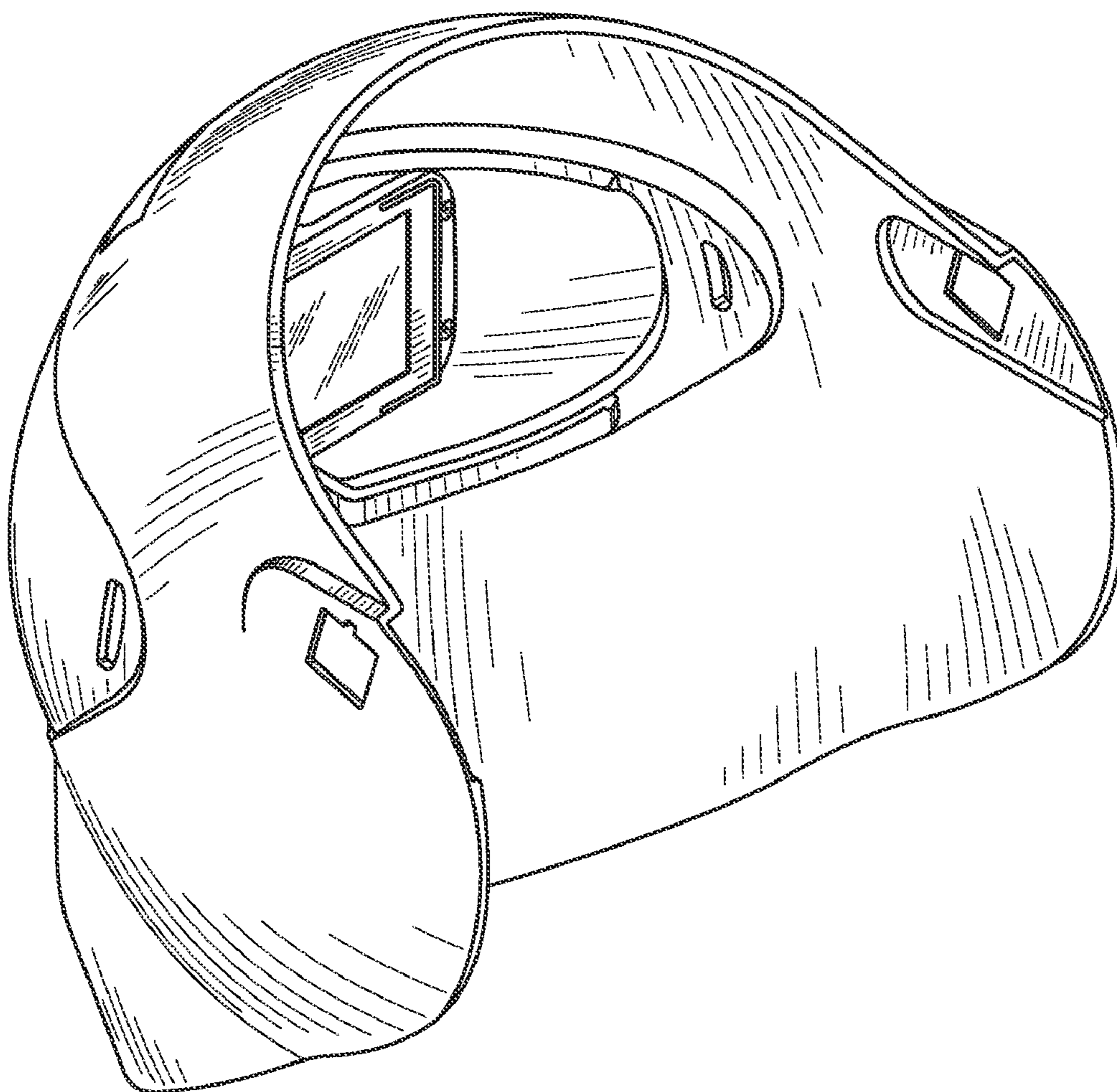

FIG. 2

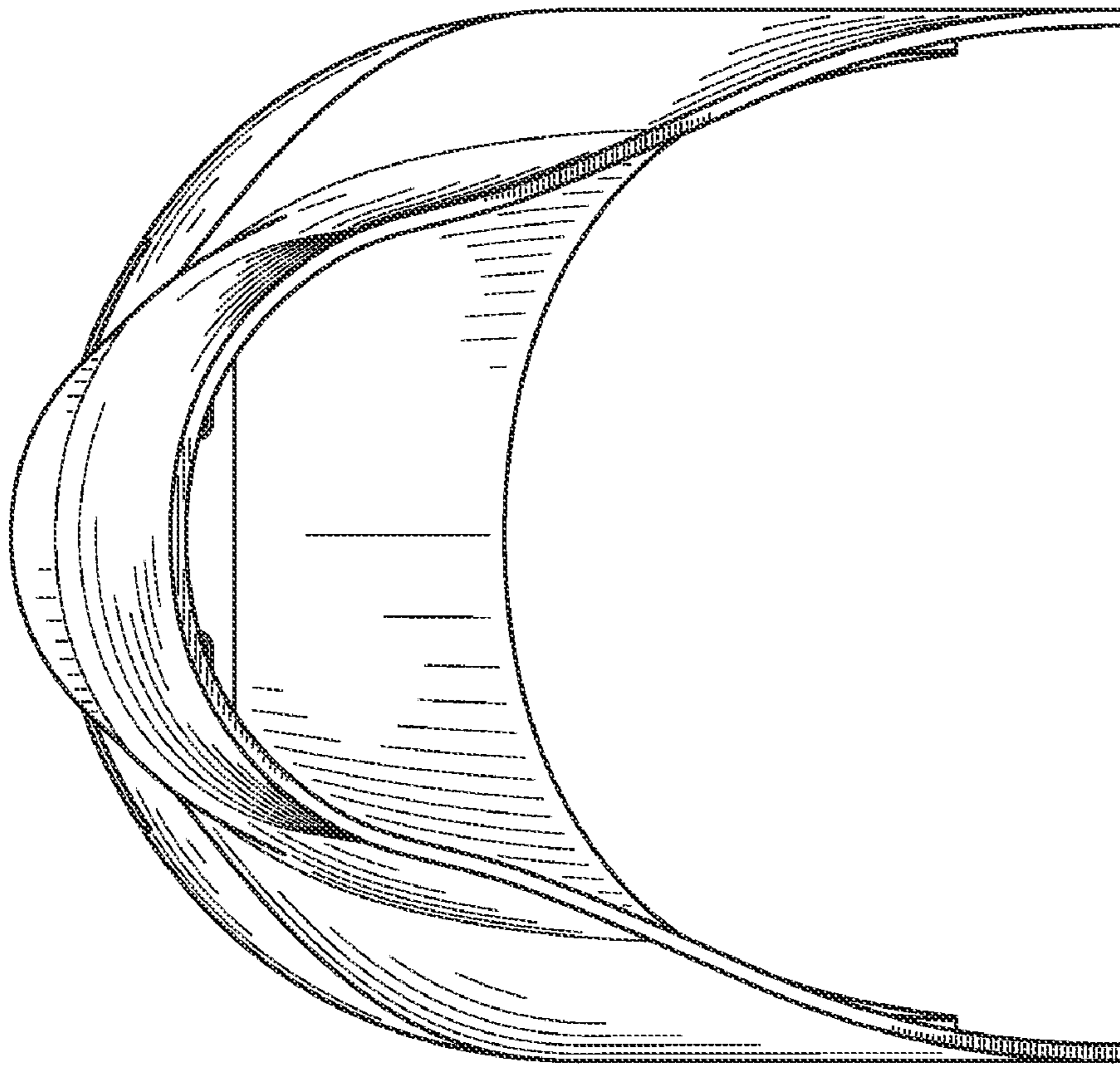

FIG. 3

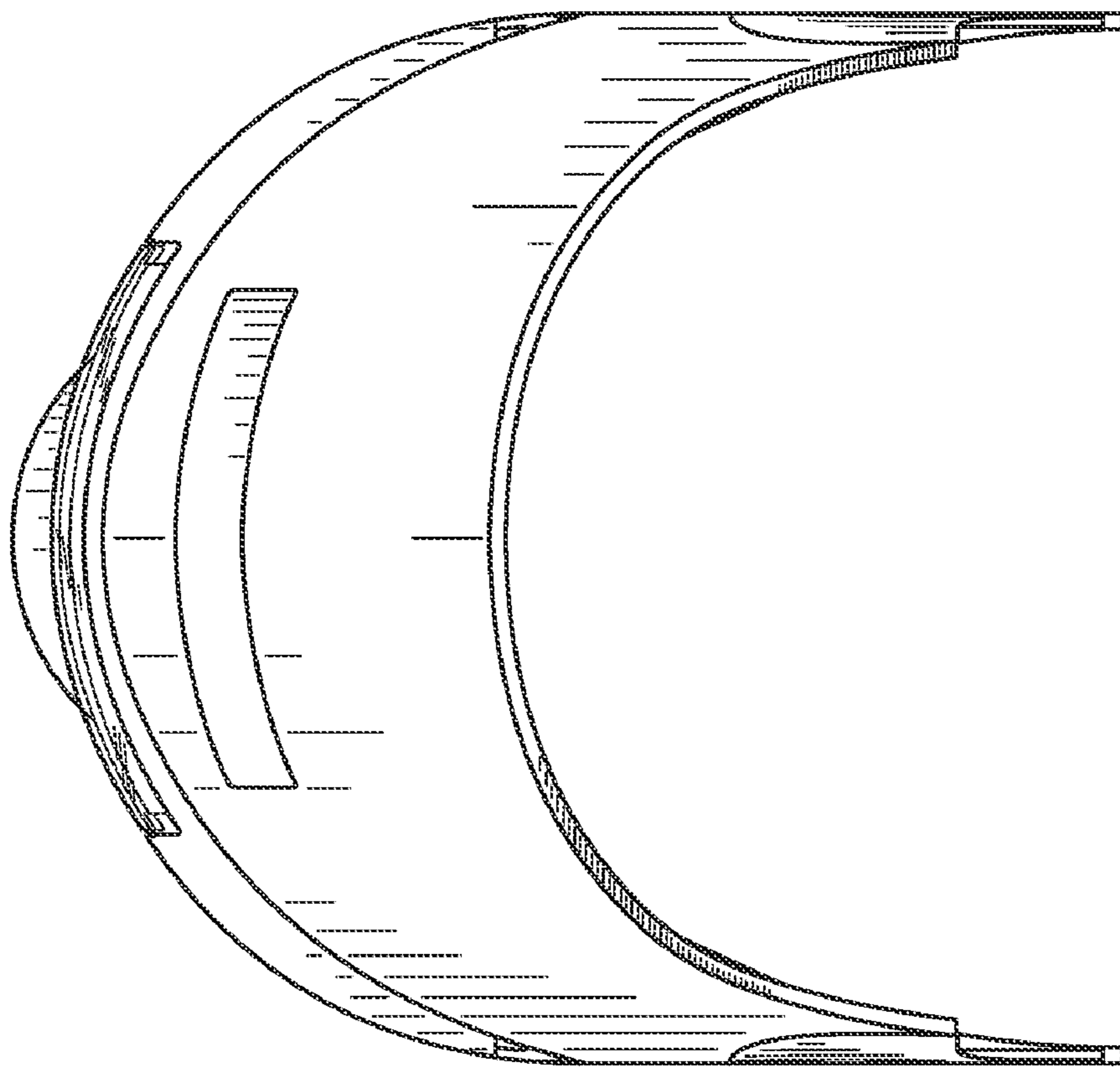

FIG. 4

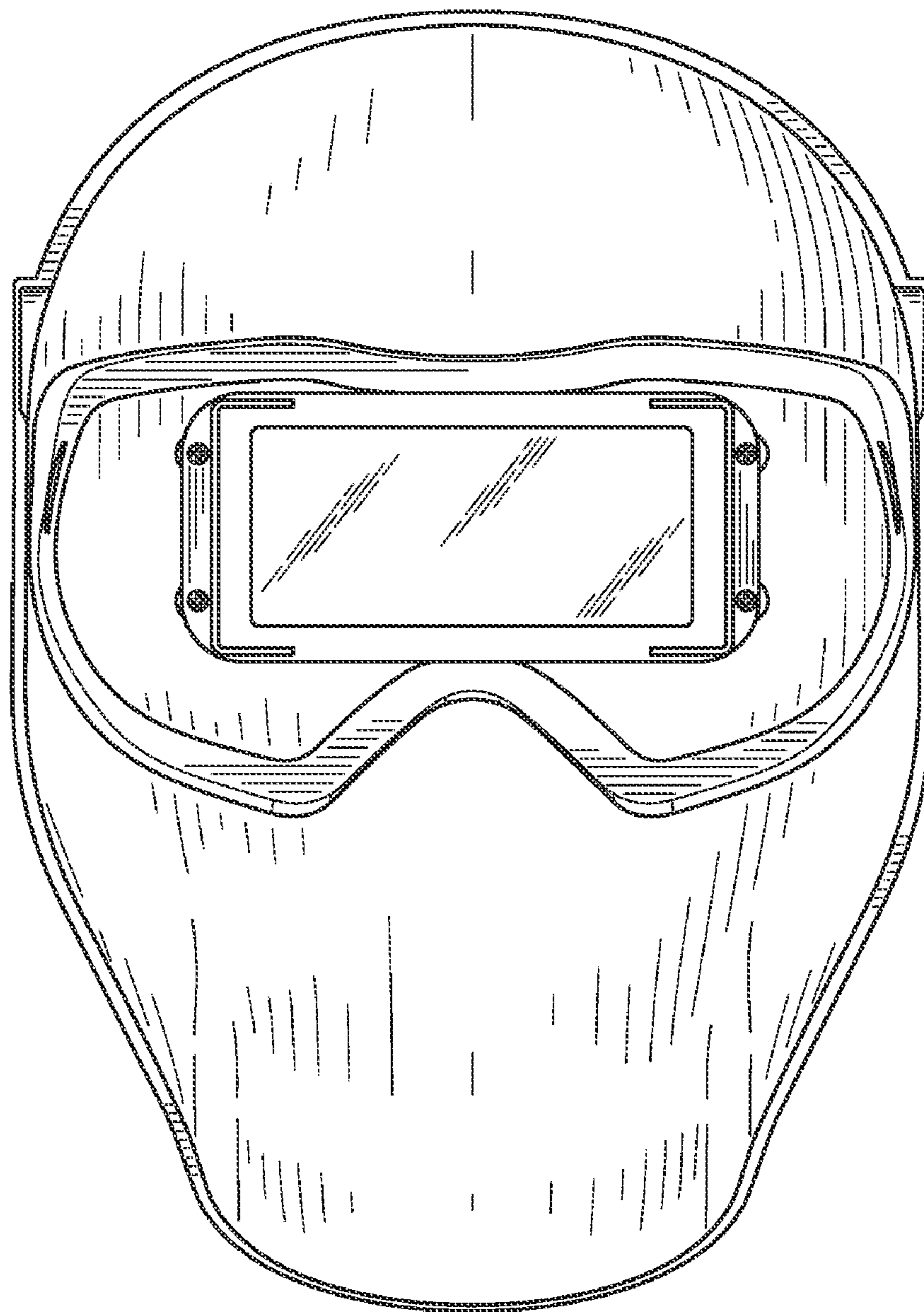

FIG. 5

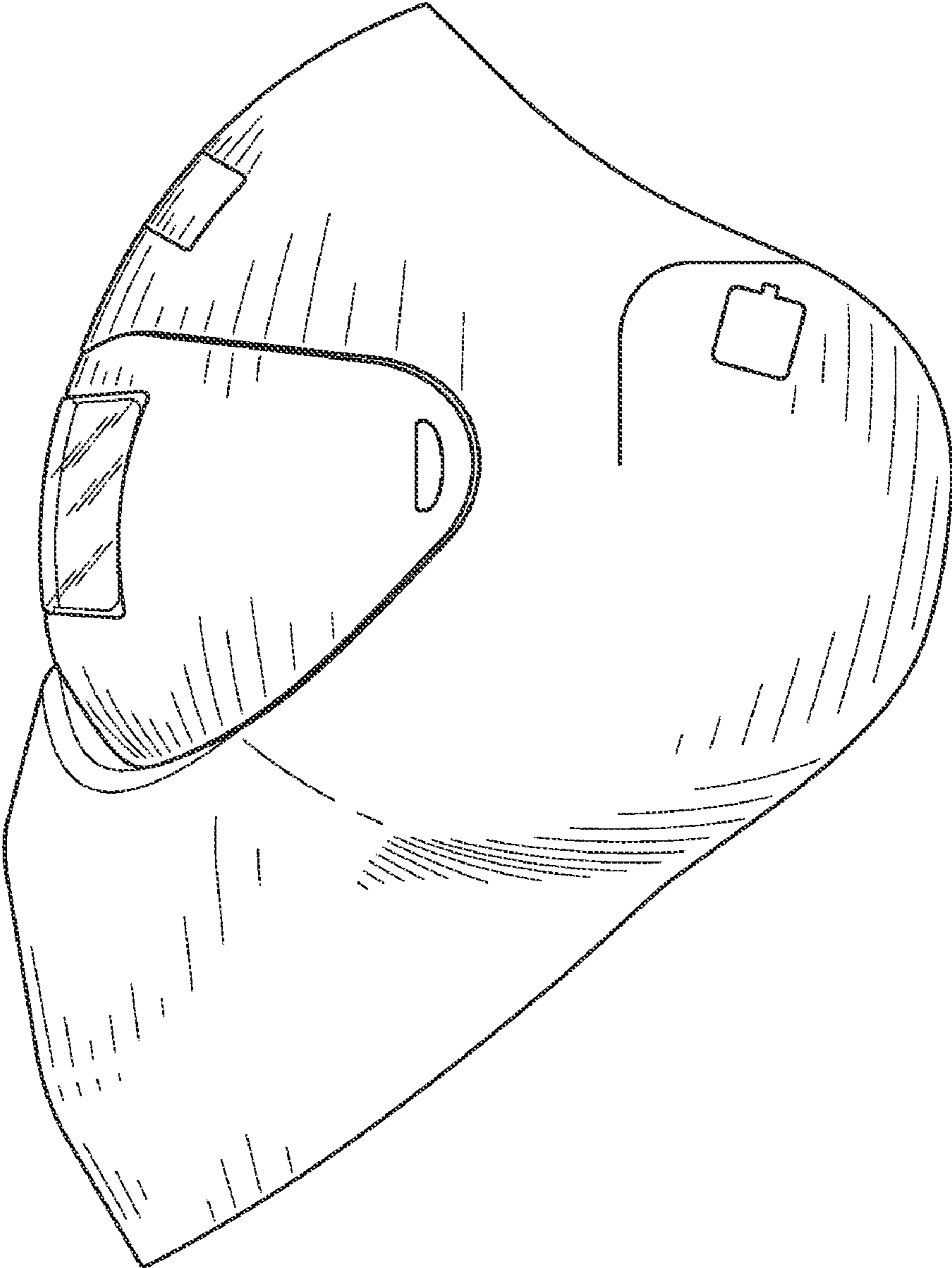

FIG. 6

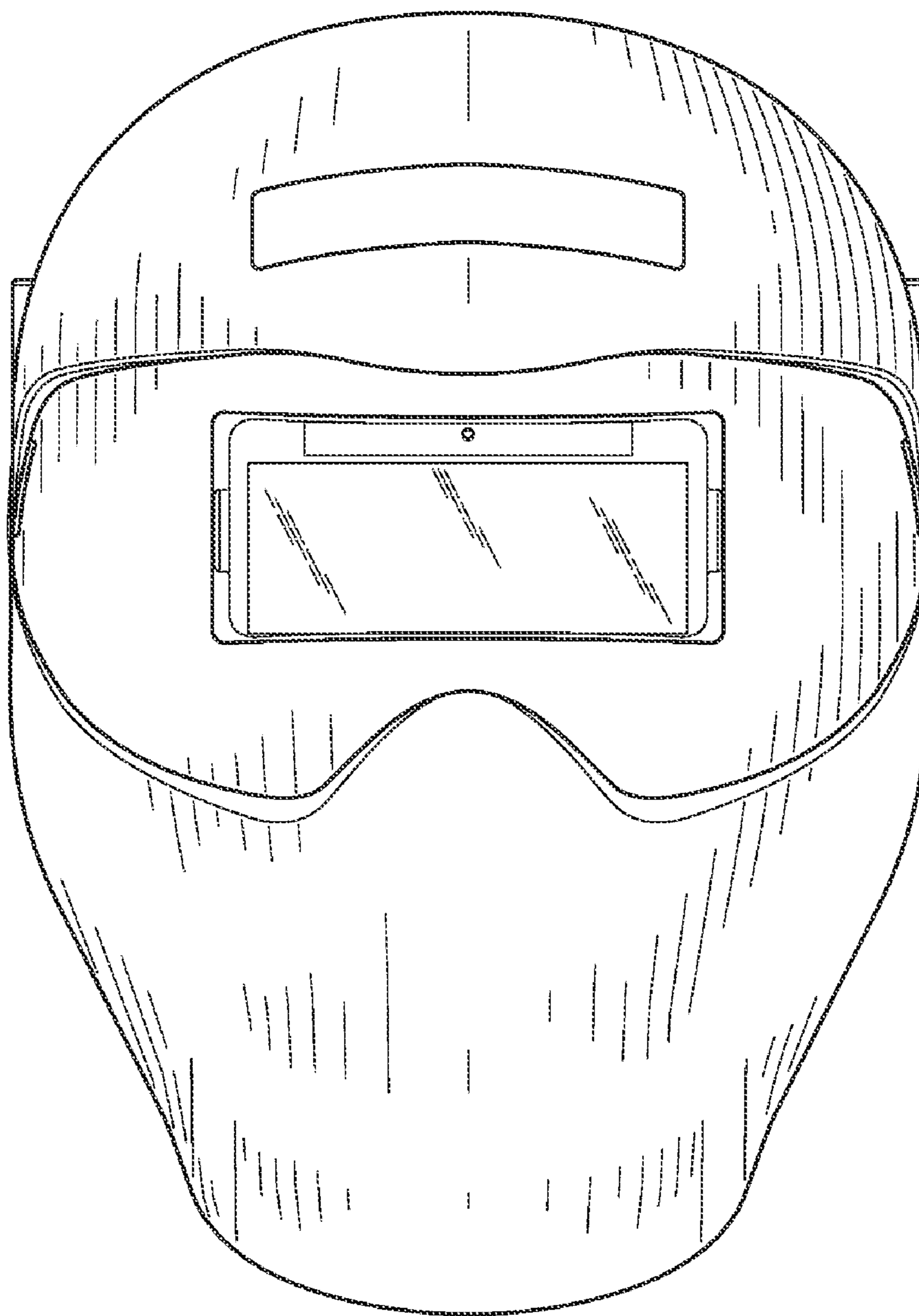

FIG. 7