



US00D640334S

(12) **United States Design Patent**
Aboody

(10) **Patent No.:** **US D640,334 S**
(45) **Date of Patent:** **** Jun. 21, 2011**

(54) **WHOLE BODY VIBRATION MACHINE**

(76) Inventor: **Morris Aboody**, Toronto (CA)

(**) Term: **14 Years**

(21) Appl. No.: **29/356,654**

(22) Filed: **Mar. 1, 2010**

(51) **LOC (9) Cl.** **21-02**

(52) **U.S. Cl.** **D21/662**

(58) **Field of Classification Search** D21/662,
D21/668, 671, 686, 688, 689; D24/200,
D24/215; 601/23, 49, 51, 66, 70, 90; 482/27,
482/51, 145, 146, 91

See application file for complete search history.

(56) **References Cited**

U.S. PATENT DOCUMENTS

D500,100 S *	12/2004	van der Meer	D21/662
D522,074 S *	5/2006	Dummel	D21/662
D548,291 S *	8/2007	Chiang	D21/662
7,278,977 B1 *	10/2007	Chen	601/30
D567,309 S *	4/2008	Schuurman et al.	D21/662
7,354,406 B2 *	4/2008	Kim	601/29
D571,416 S *	6/2008	Wu	D21/662
D576,228 S *	9/2008	Hahn	D21/668

2006/0009329 A1 *	1/2006	Toyama et al.	482/51
2006/0155221 A1 *	7/2006	Kim	601/29
2008/0281239 A1 *	11/2008	Tamminga	601/49
2008/0300520 A1 *	12/2008	Shin	601/49
2009/0247914 A1 *	10/2009	Shen et al.	601/49

* cited by examiner

Primary Examiner — Susan E Krakower

(57) **CLAIM**

The ornamental design for a whole body vibration machine, as shown and described.

DESCRIPTION

FIG. 1 is a perspective view of a whole body vibration machine showing my new design;
FIG. 2 is a top view thereof;
FIG. 3 is a bottom view thereof;
FIG. 4 is a front view thereof;
FIG. 5 is a back view thereof;
FIG. 6 is a left side view thereof; and,
FIG. 7 is a right side view thereof.
The broken lines illustrate environmental elements of a whole body vibration machine, which forms no part of the claimed design.

1 Claim, 7 Drawing Sheets

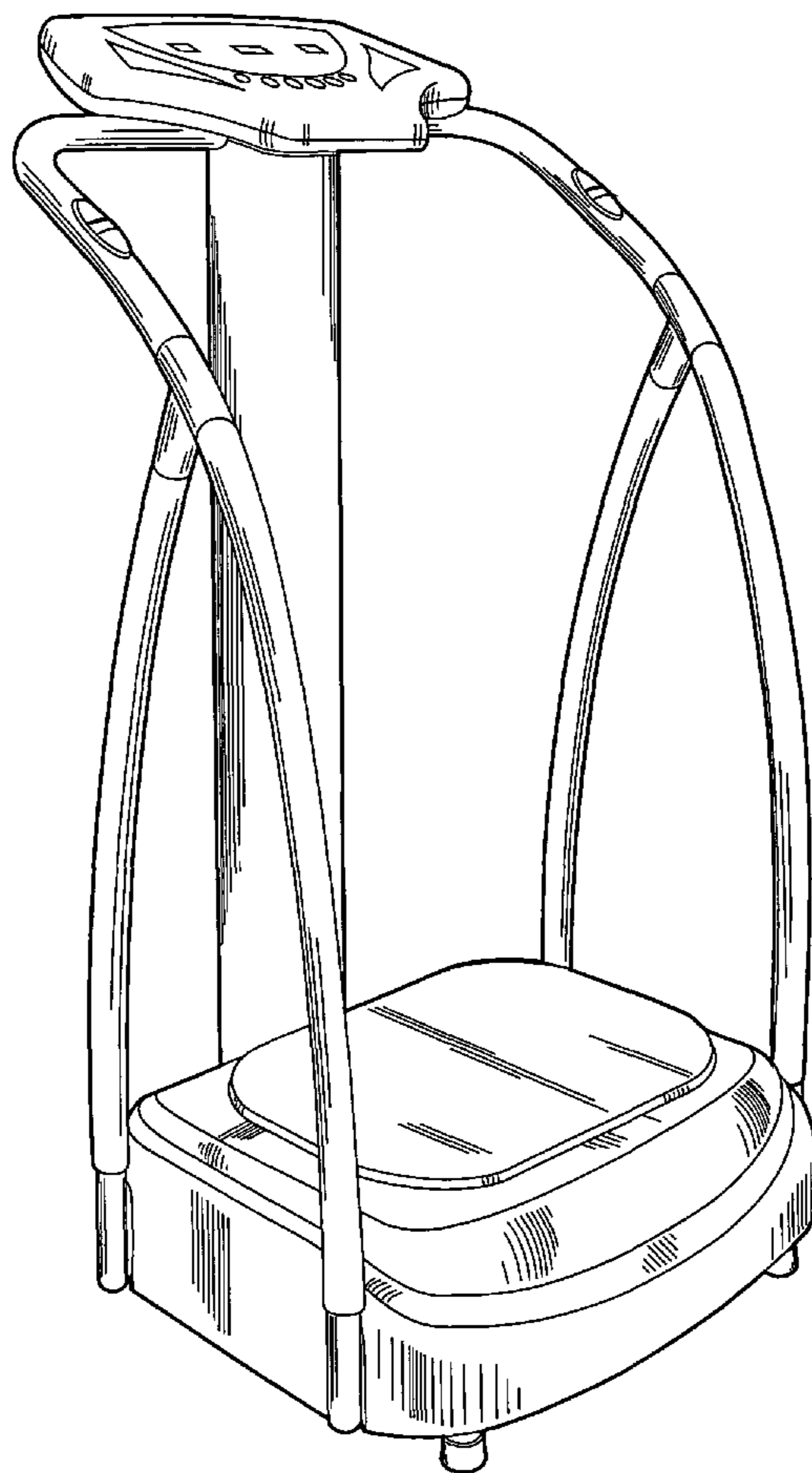

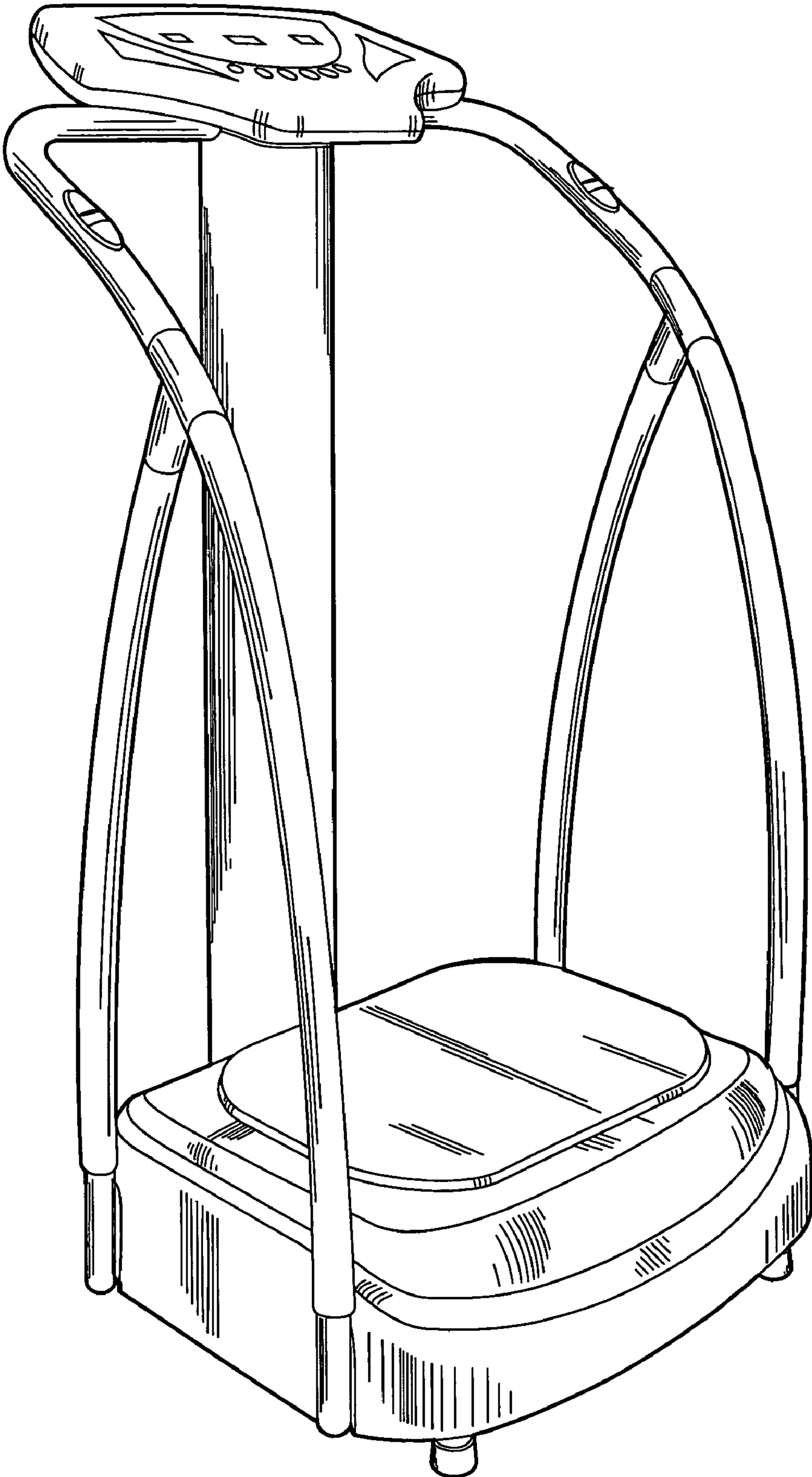

Figure 1

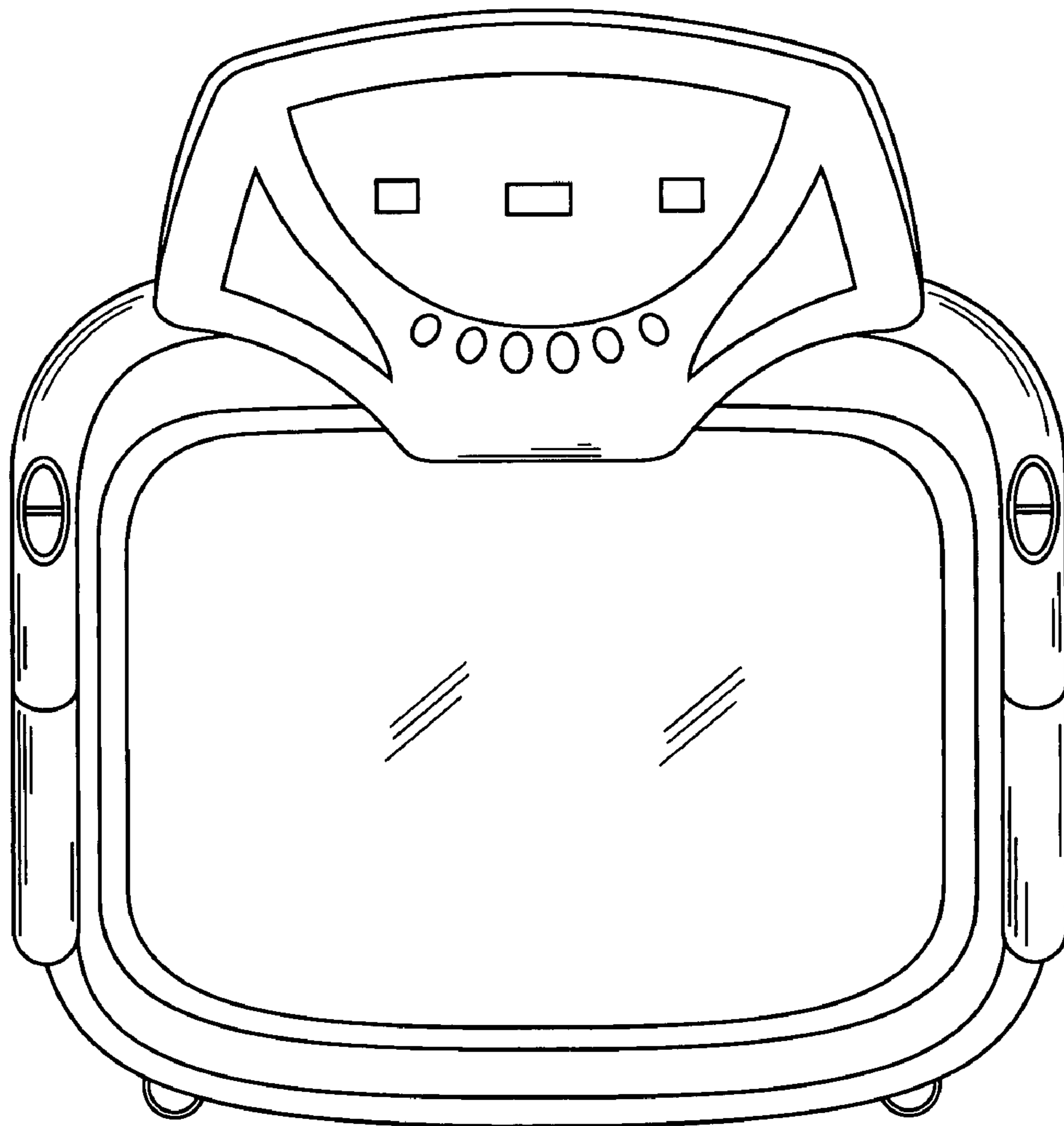

Figure 2

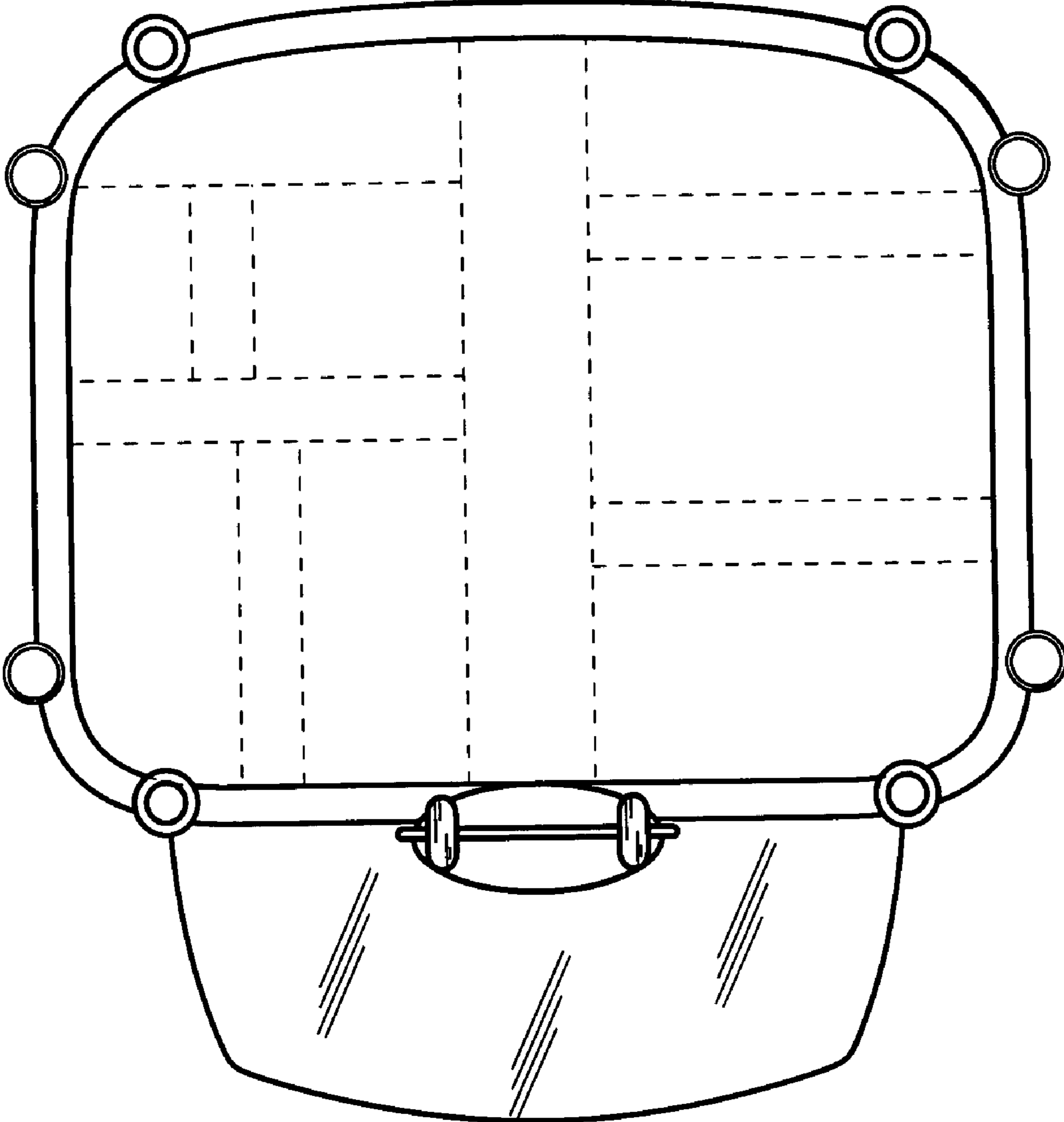

Figure 3

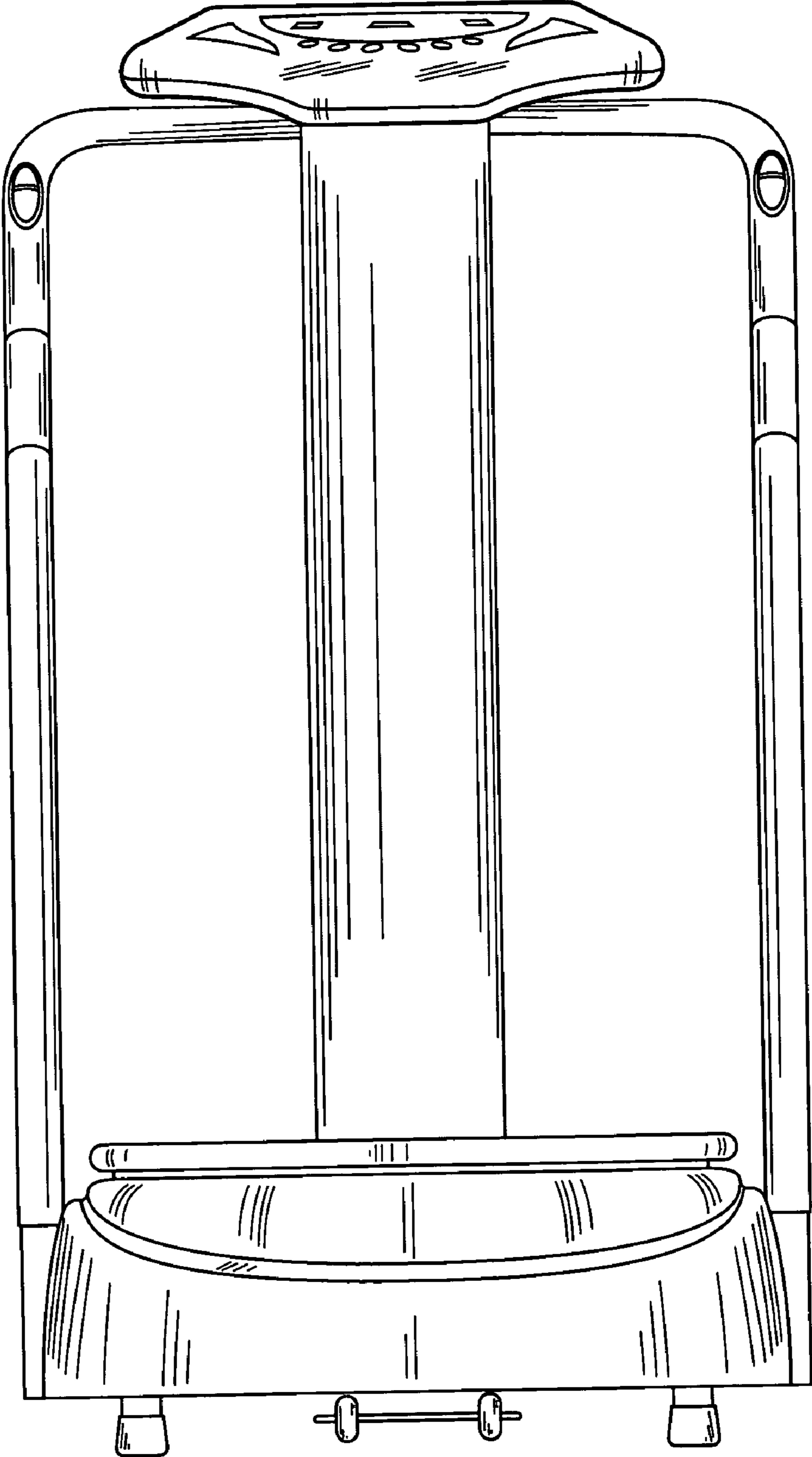

Figure 4

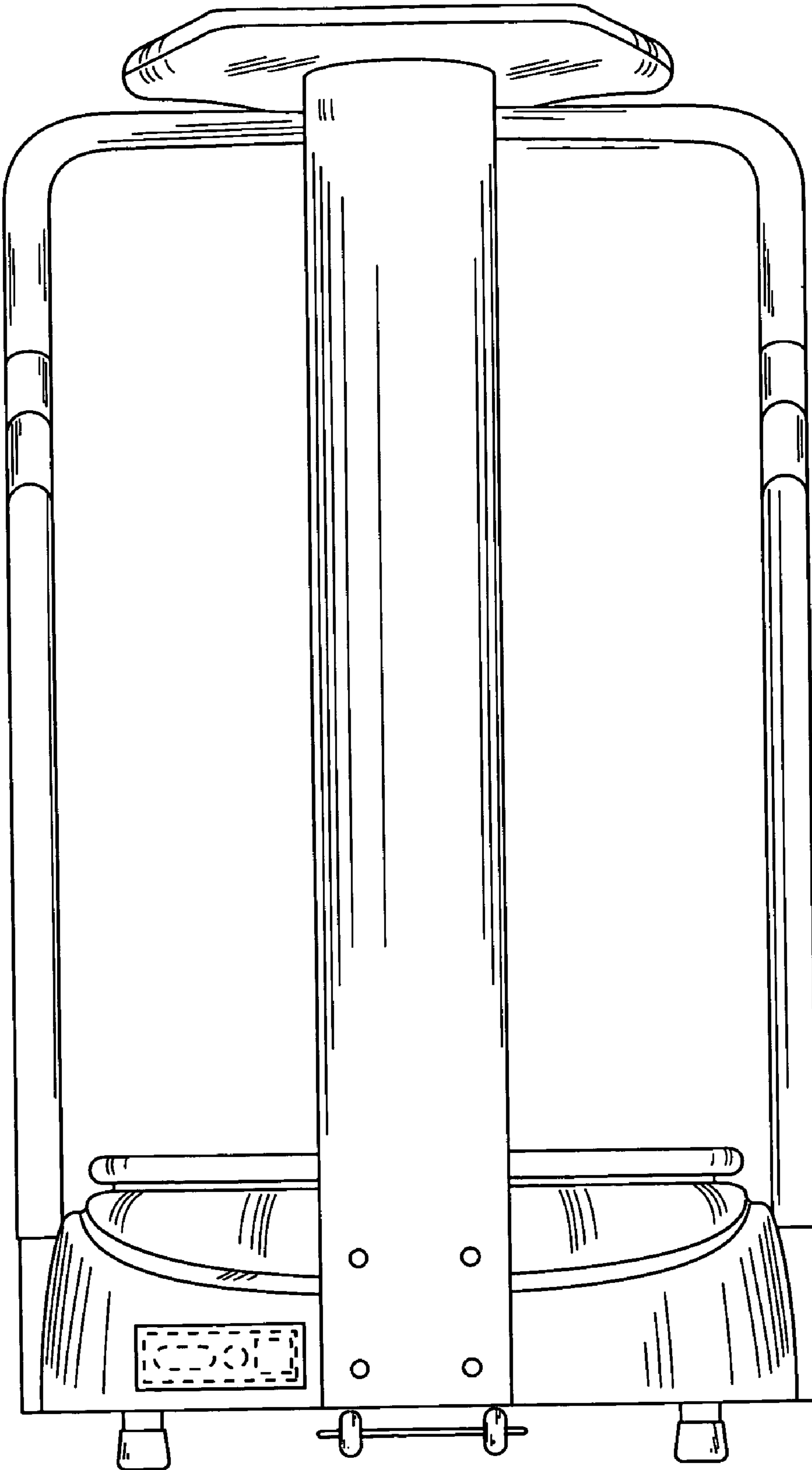

Figure 5

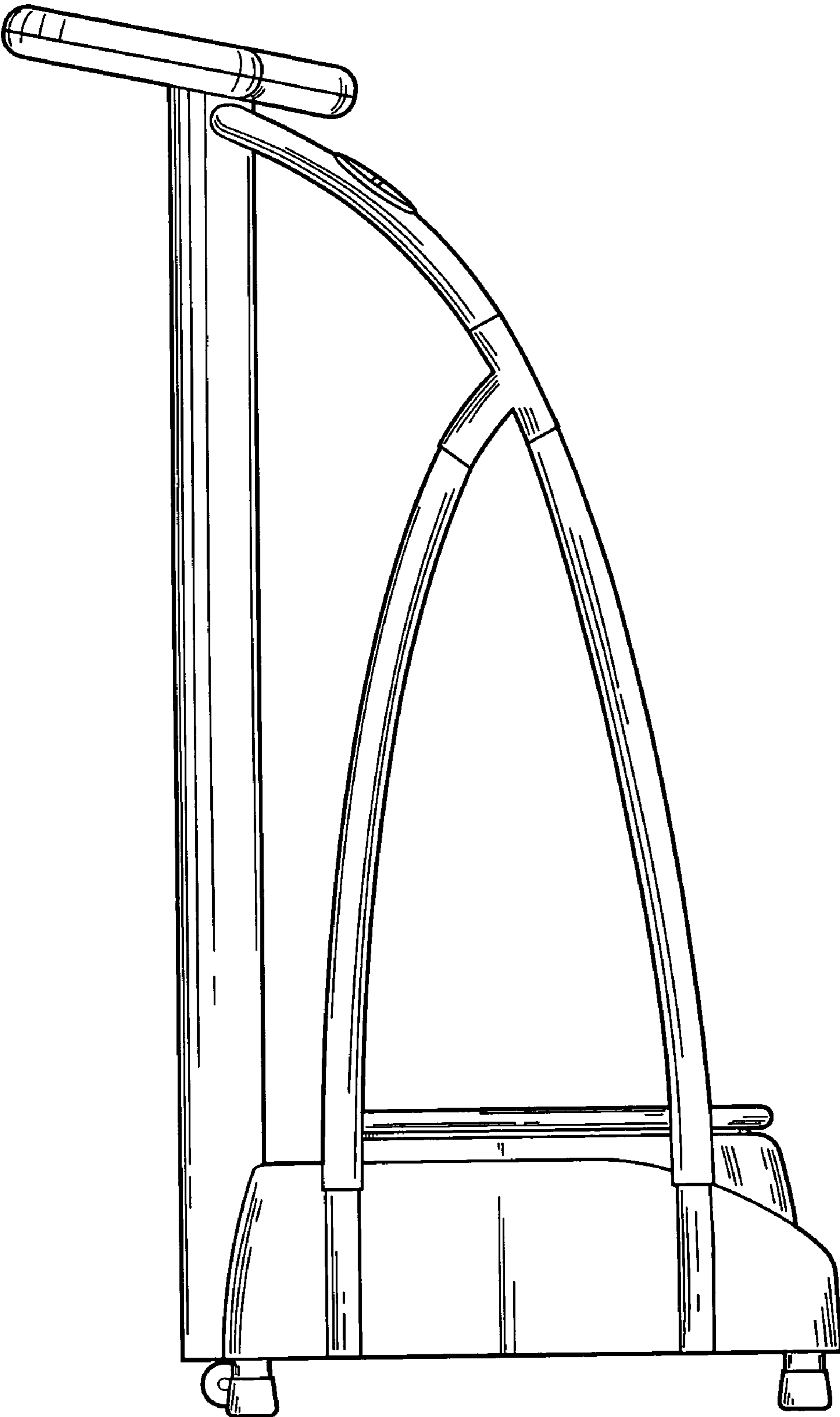

Figure 6

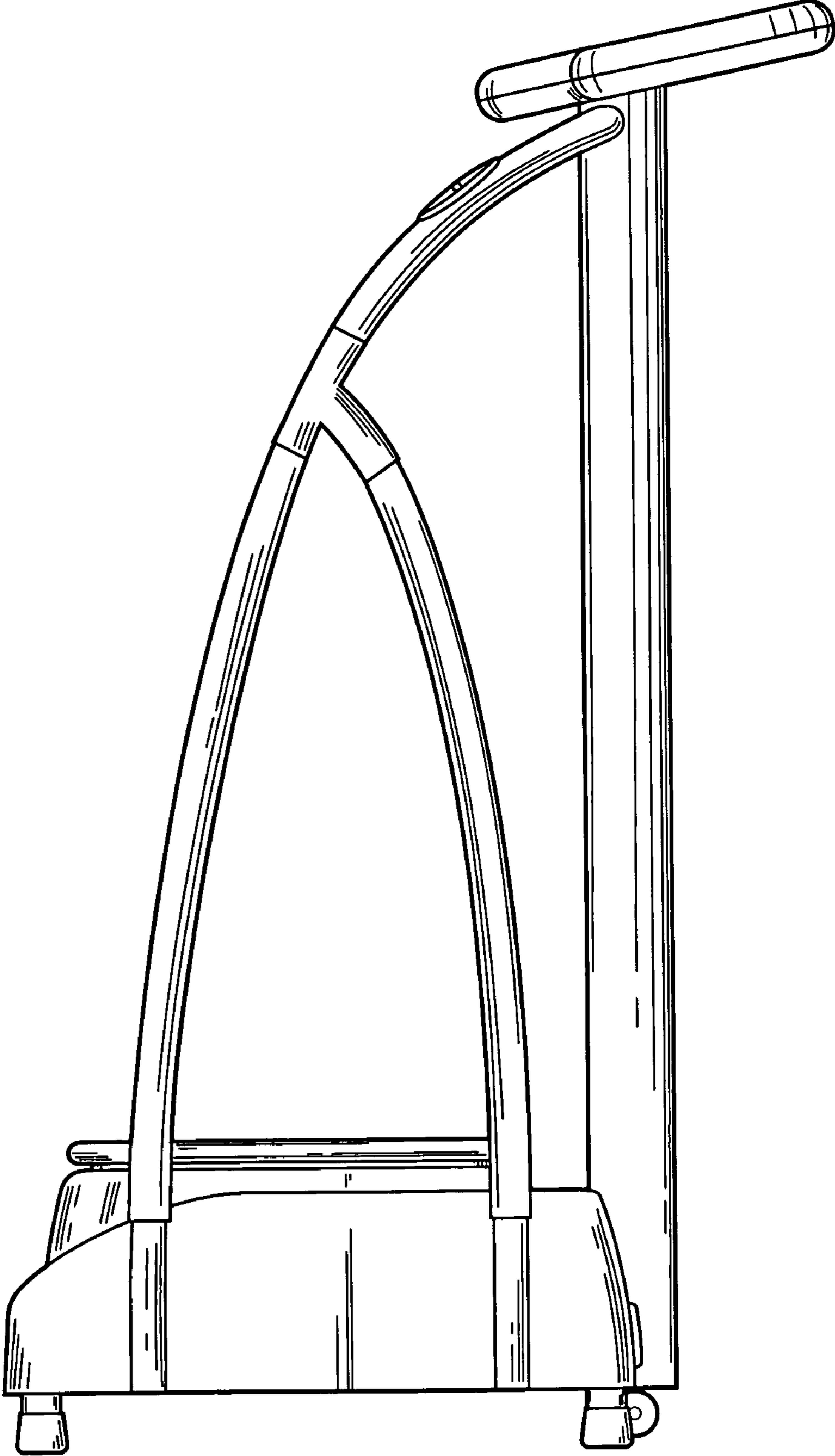

Figure 7