



US00D640231S

(12) **United States Design Patent**
Joseph

(10) **Patent No.:** **US D640,231 S**

(45) **Date of Patent:** **** Jun. 21, 2011**

(54) **ALARM CLOCK RADIO FOR DIGITAL MEDIA PLAYER**

(75) Inventor: **Brian Joseph**, Brooklyn, NY (US)

(73) Assignee: **SDI Technologies, Inc.**, Rahway, NJ (US)

(**) Term: **14 Years**

(21) Appl. No.: **29/266,095**

(22) Filed: **Sep. 14, 2006**

(51) **LOC (9) Cl.** **14-03**

(52) **U.S. Cl.** **D14/171**

(58) **Field of Classification Search** D14/137,
D14/155, 156, 168, 170, 171, 193-198, 217,
D14/496; D10/1, 2, 15; 312/7.1; 369/6-12;
455/91, 95, 100, 128, 344, 347, 350, 351
See application file for complete search history.

(56) **References Cited**

U.S. PATENT DOCUMENTS

D227,929 S *	7/1973	Tuksoka et al.	D14/198
D389,686 S *	1/1998	Drage	D6/528
D443,522 S *	6/2001	Byler et al.	D10/1
D460,962 S *	7/2002	Peiker	D14/253
D466,101 S *	11/2002	Hu	D14/171
D470,832 S *	2/2003	Oikawa	D14/168
D471,179 S *	3/2003	Suzuki et al.	D14/215

D475,362 S *	6/2003	Suzuki	D14/168
D477,302 S *	7/2003	Narita	D14/168
D525,966 S *	8/2006	Cook	D14/214
D542,279 S *	5/2007	Chan	D14/216
D565,594 S *	4/2008	Poandl	D14/496

* cited by examiner

Primary Examiner — Ian Simmons

Assistant Examiner — Keli L Acker

(74) *Attorney, Agent, or Firm* — Ostrolenk, Faber, Gerb & Soffen, LLP

(57) **CLAIM**

The ornamental design for an alarm clock radio for digital media player, as shown.

DESCRIPTION

FIG. 1 is a top, front, right side perspective view of an alarm clock radio for digital media player showing my new design; FIG. 2 is a front view thereof; FIG. 3 is a right side view thereof; FIG. 4 is a left side view thereof; FIG. 5 is a rear view thereof; FIG. 6 is a top view thereof; and, FIG. 7 is bottom view thereof. The broken line showing of the media player dock is for illustrative purposes only and forms no part of the claimed design.

1 Claim, 7 Drawing Sheets

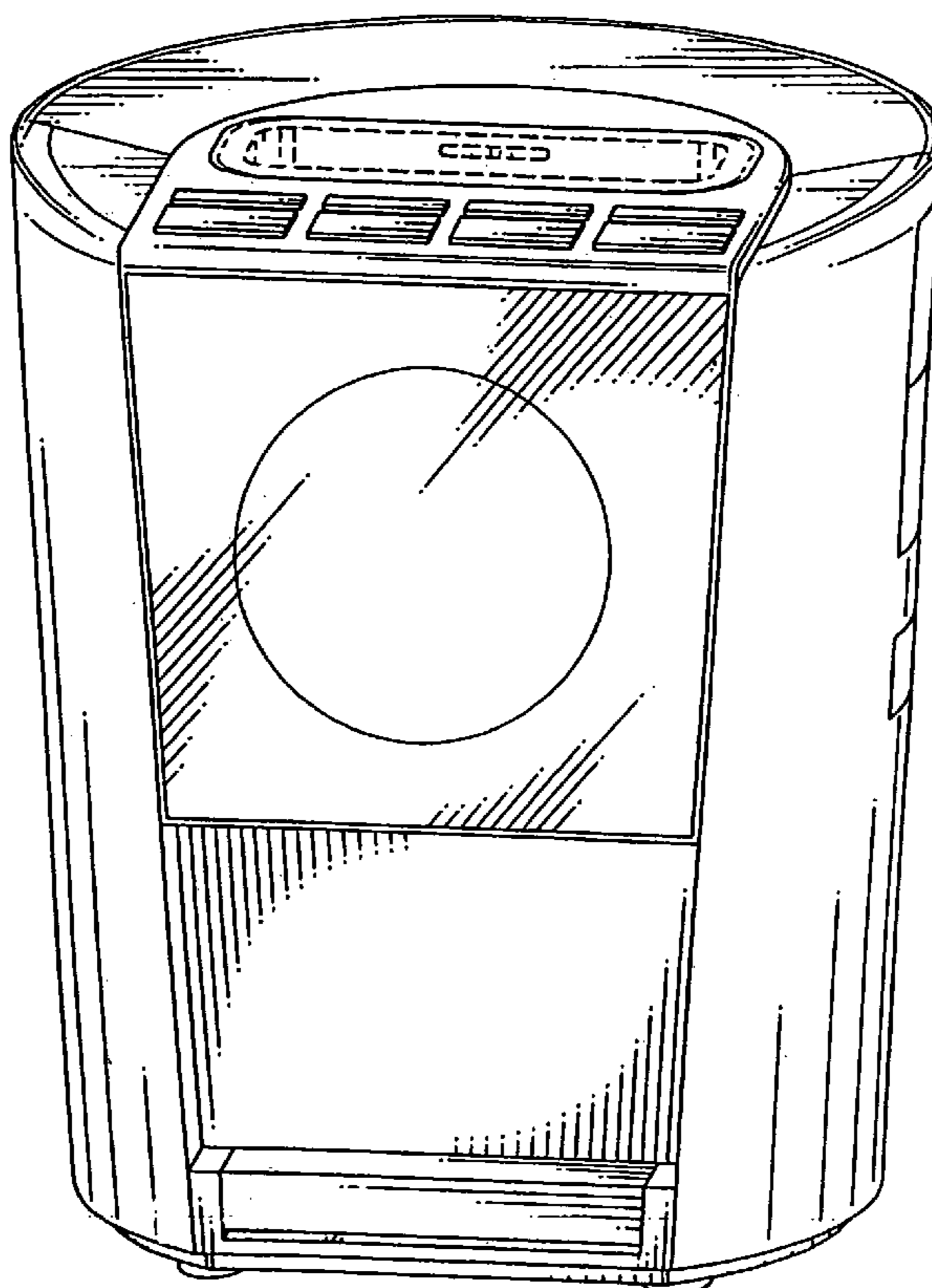

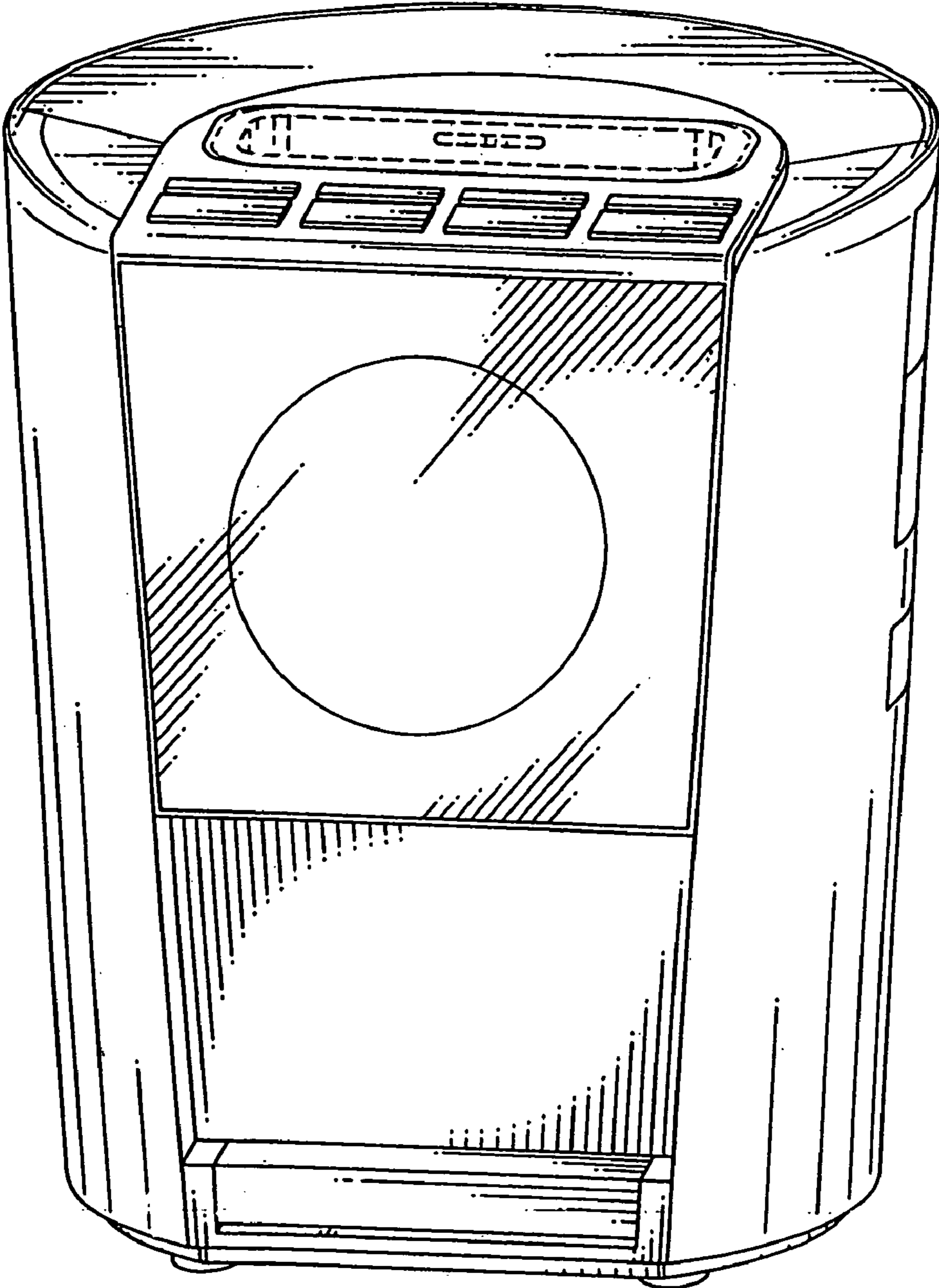

FIG. 1

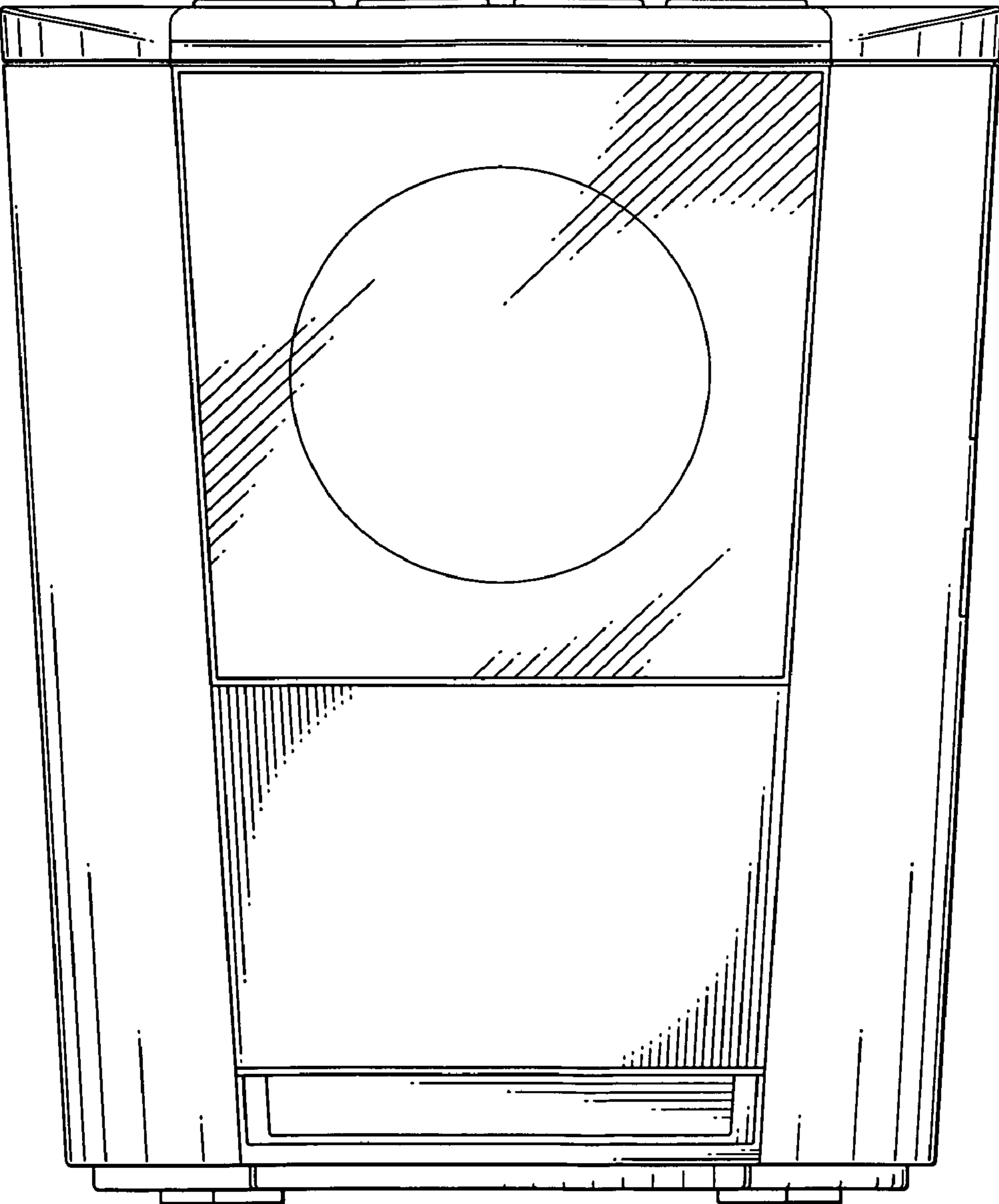

FIG. 2

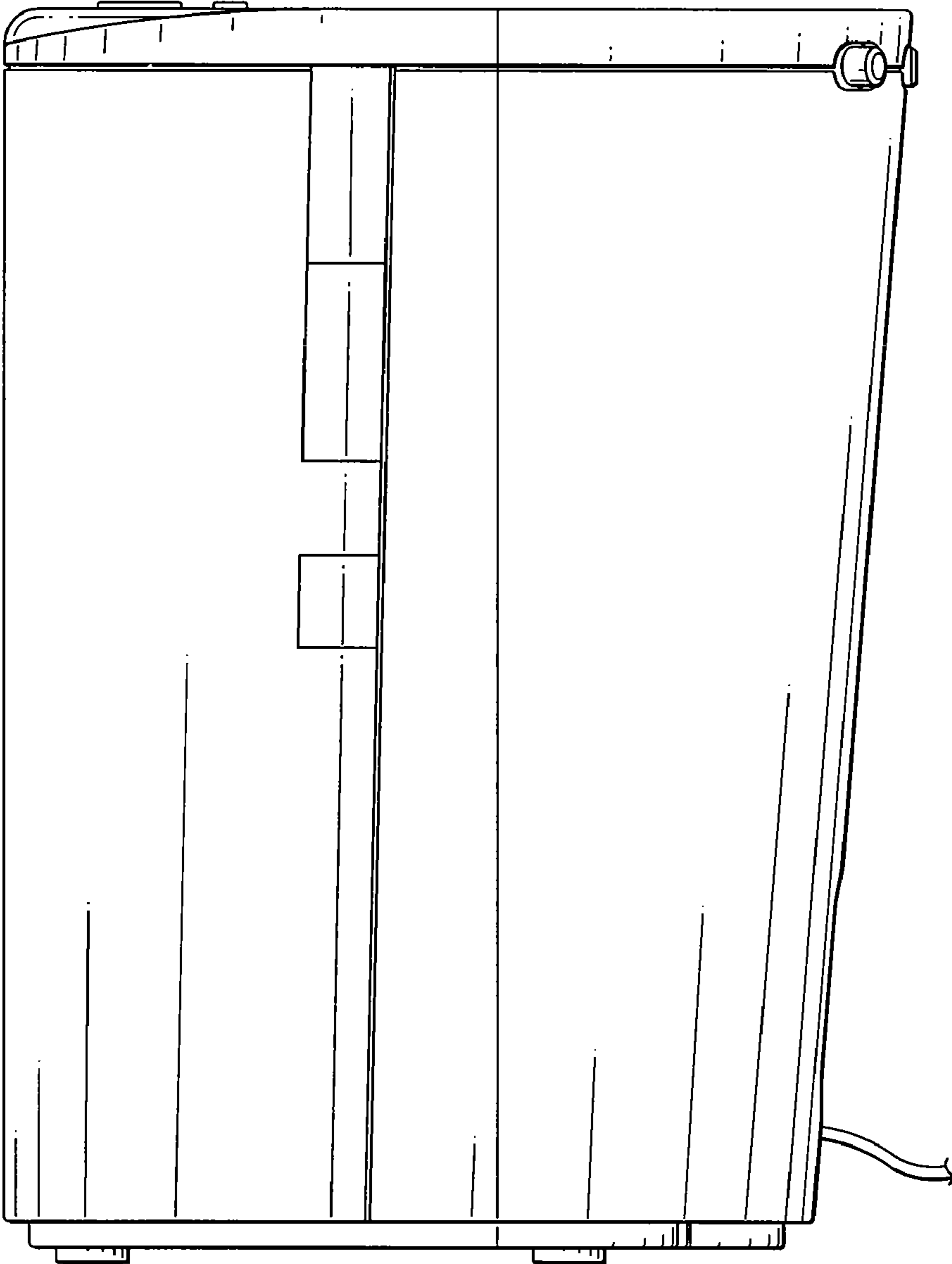

FIG. 3

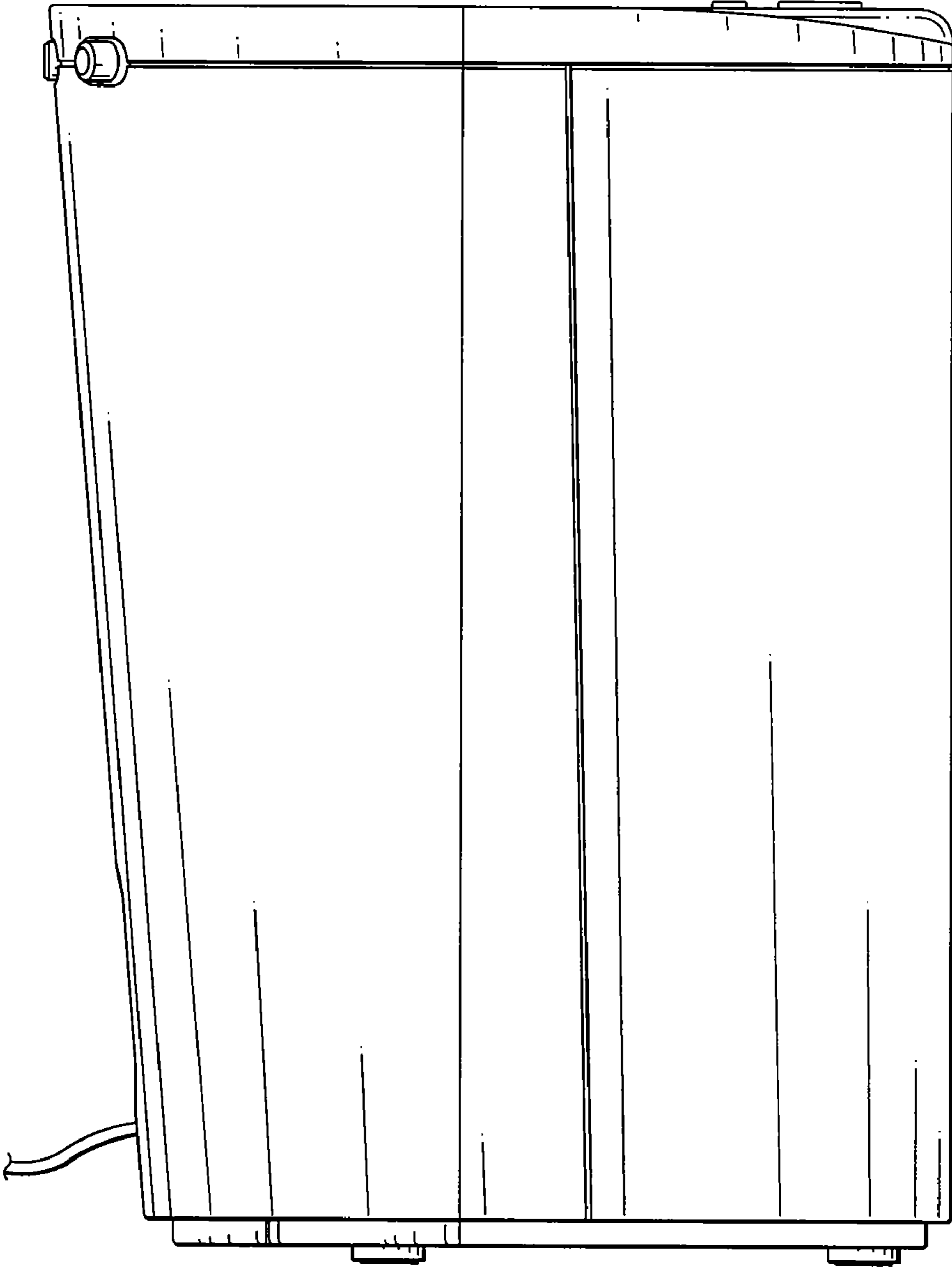

FIG. 4

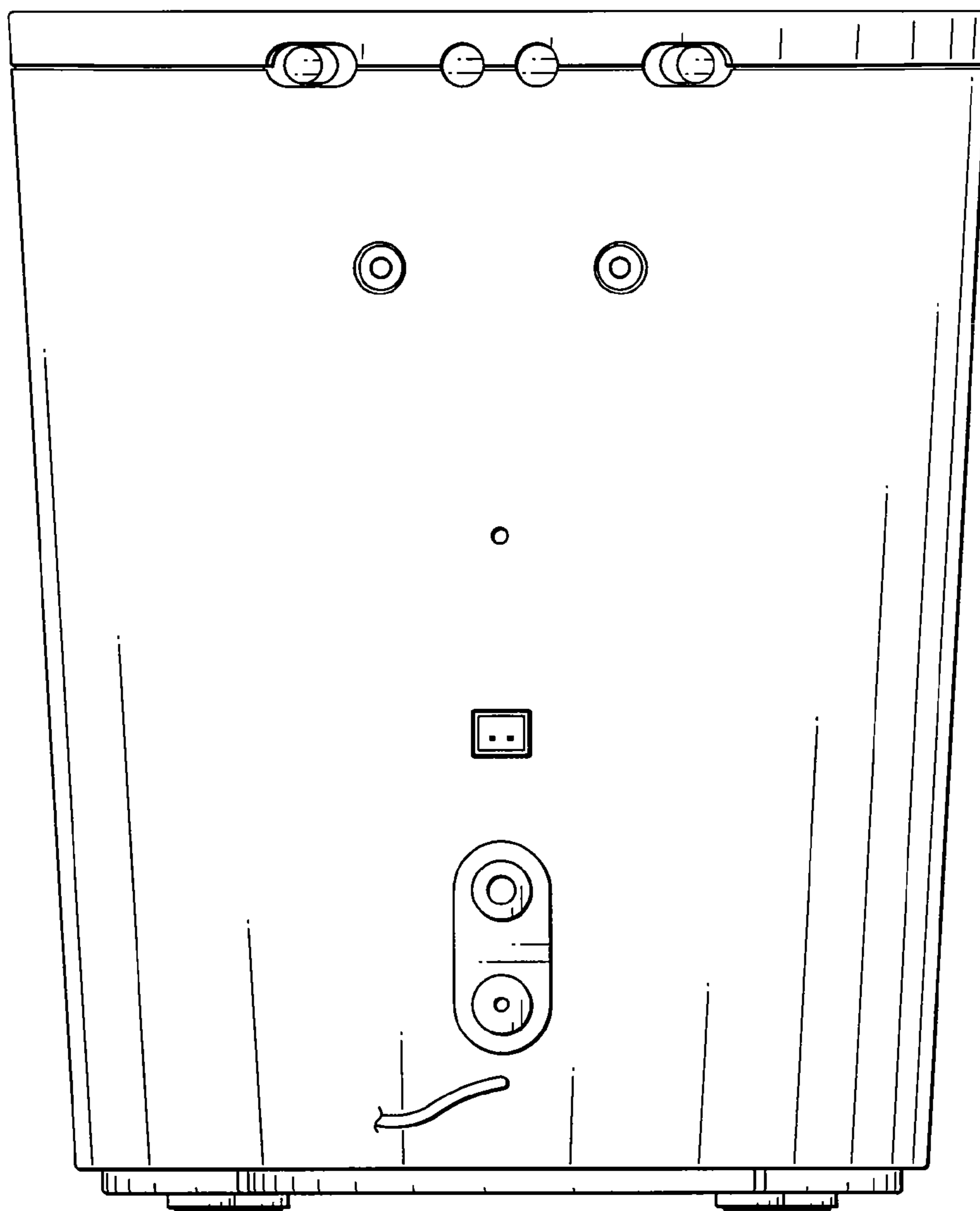

FIG. 5

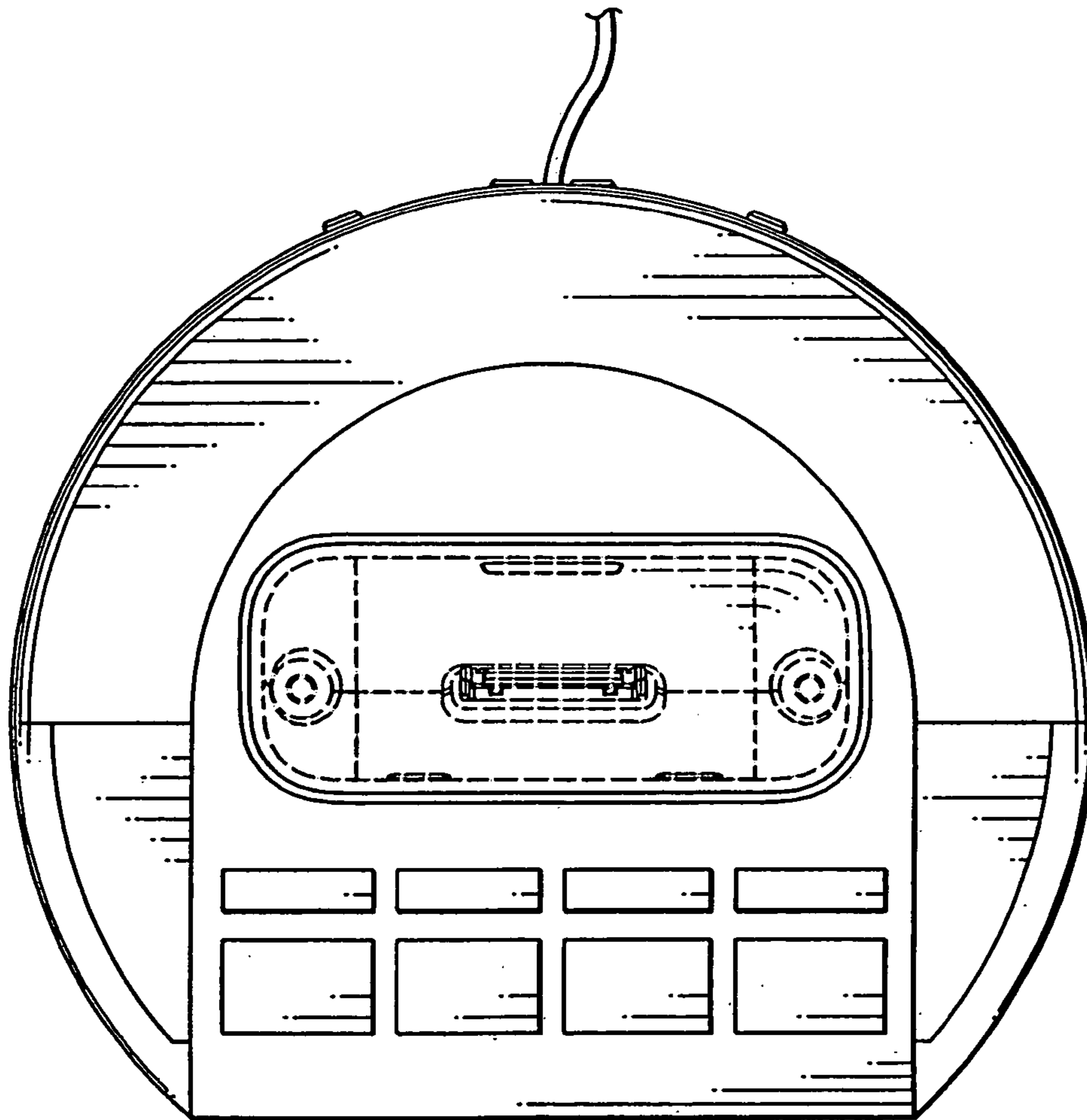

FIG. 6

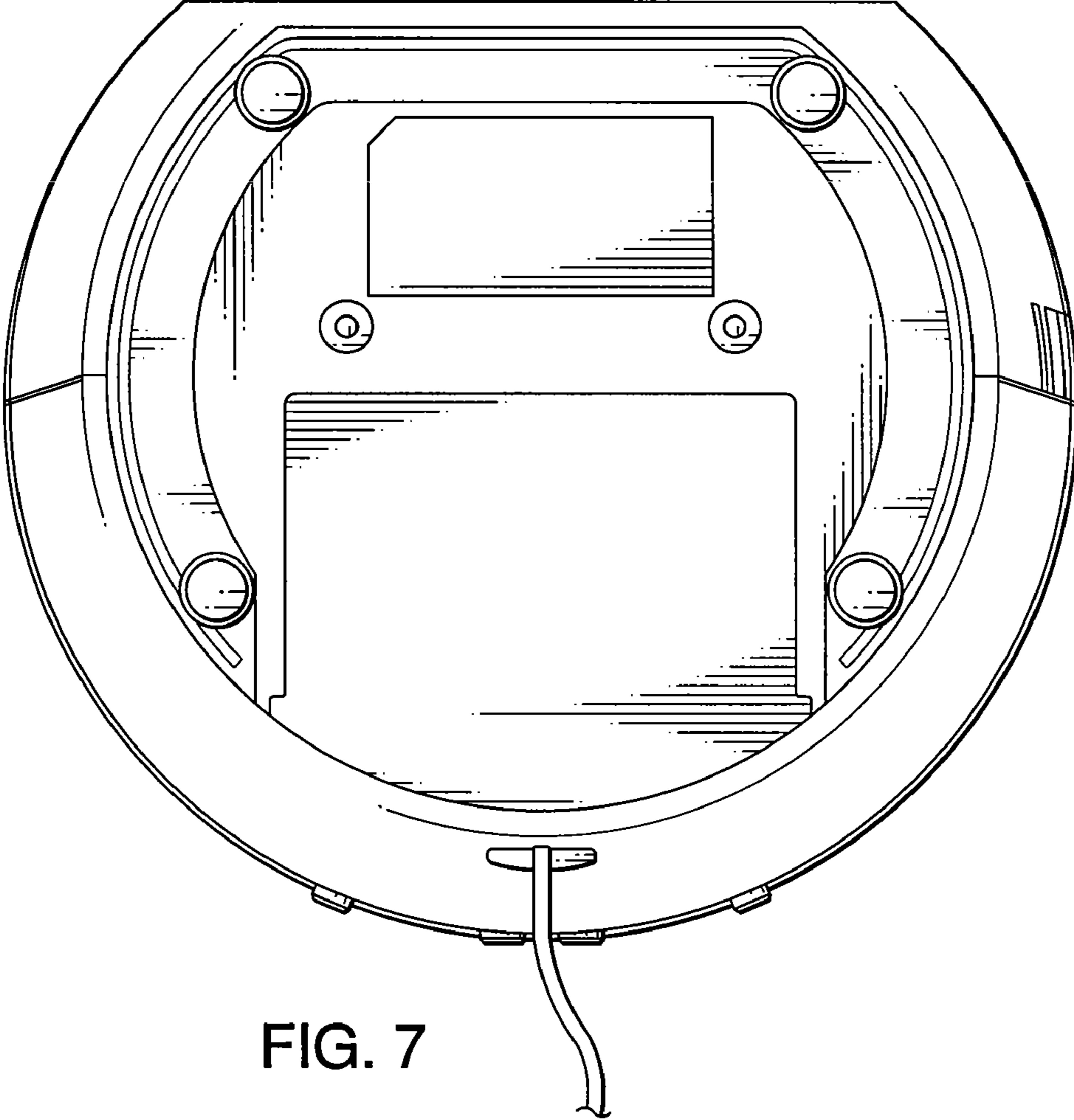

FIG. 7