



US00D640197S

(12) **United States Design Patent**
Park et al.

(10) **Patent No.:** **US D640,197 S**

(45) **Date of Patent:** **** Jun. 21, 2011**

(54) **BATTERY PACK**

(75) Inventors: **Keith Park**, York (GB); **Jianjun Shuang**, Nanjing (CN)

(73) Assignee: **Chervon Limited**, Wanchai (HK)

(**) Term: **14 Years**

(21) Appl. No.: **29/378,908**

(22) Filed: **Nov. 11, 2010**

(30) **Foreign Application Priority Data**

May 13, 2010 (CN) 2010 3 0170346

(51) **LOC (9) Cl.** **13-02**

(52) **U.S. Cl.** **D13/119; D13/103**

(58) **Field of Classification Search** D13/102-106,
D13/110, 118-121, 184, 199; 429/96-100,
429/163, 176

See application file for complete search history.

(56) **References Cited**

U.S. PATENT DOCUMENTS

D415,100 S *	10/1999	Buck	D13/103
D545,759 S *	7/2007	Ino et al.	D13/103
D555,086 S *	11/2007	Zhang	D13/103
D556,677 S *	12/2007	Watson	D13/103
D562,227 S *	2/2008	Yamada et al.	D13/103
D562,228 S *	2/2008	Okada et al.	D13/103

D588,986 S *	3/2009	Zhang	D13/110
D589,439 S *	3/2009	Van Wambeke	D13/103
D589,440 S *	3/2009	Van Wambeke	D13/103
D589,441 S *	3/2009	Van Wambeke	D13/103
D622,661 S *	8/2010	Yamada et al.	D13/103
D633,036 S *	2/2011	Murray	D13/103

* cited by examiner

Primary Examiner — Rosemary K Tarcza

(74) *Attorney, Agent, or Firm* — McDermott Will & Emery LLP

(57) **CLAIM**

We claim the ornamental design for a battery pack, as shown and described.

DESCRIPTION

FIG. 1 is a right side view of a battery pack according to the new design.

FIG. 2 is a left side view of the battery pack shown in FIG. 1.

FIG. 3 is a front view of the battery pack shown in FIG. 1.

FIG. 4 is a rear view of the battery pack shown in FIG. 1.

FIG. 5 is a top view of the battery pack shown in FIG. 1.

FIG. 6 is a bottom view of the battery pack shown in FIG. 1; and,

FIG. 7 is a perspective view of the battery pack shown in FIG. 1.

The broken lines shown in the drawings are included for the purpose of illustrating unclaimed portions of the battery pack and form no part of the claimed design.

1 Claim, 7 Drawing Sheets

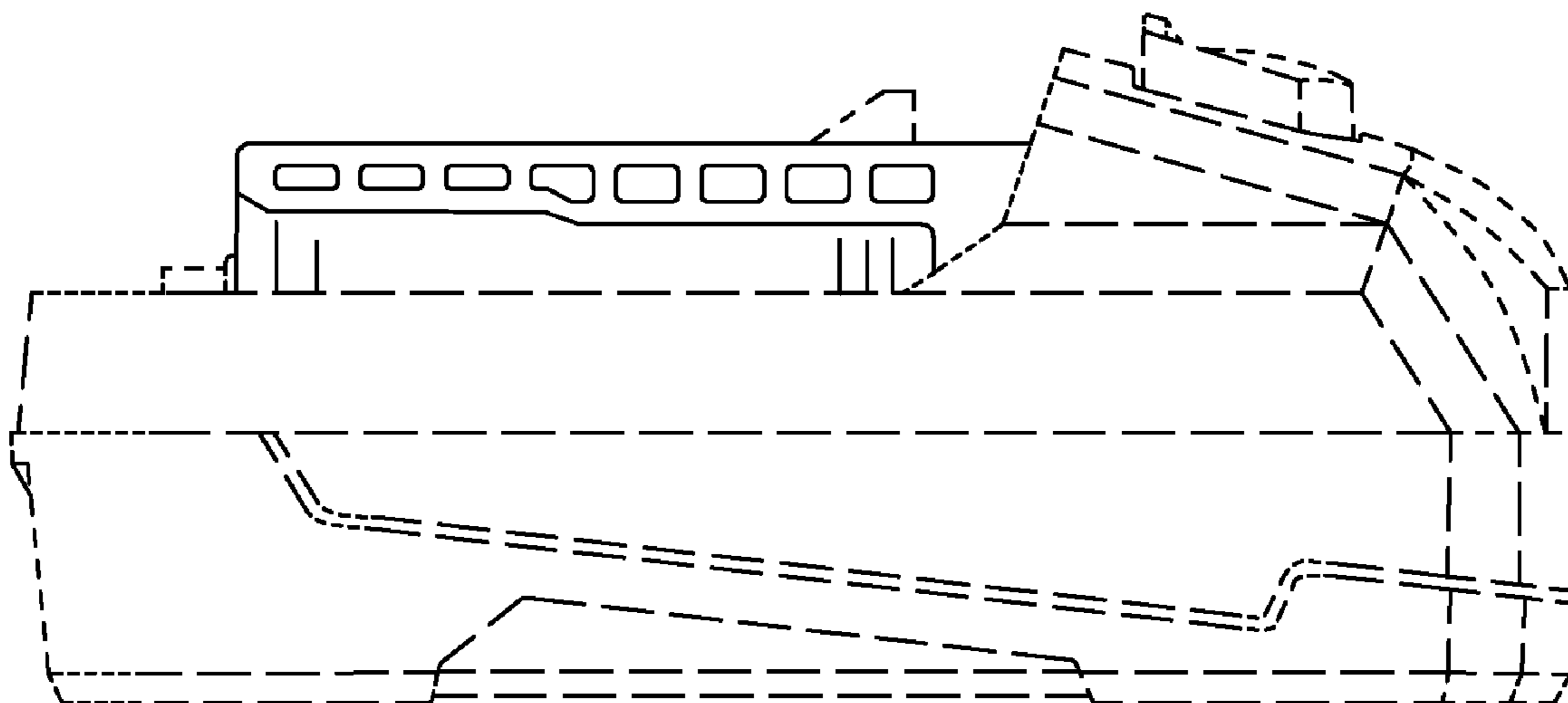

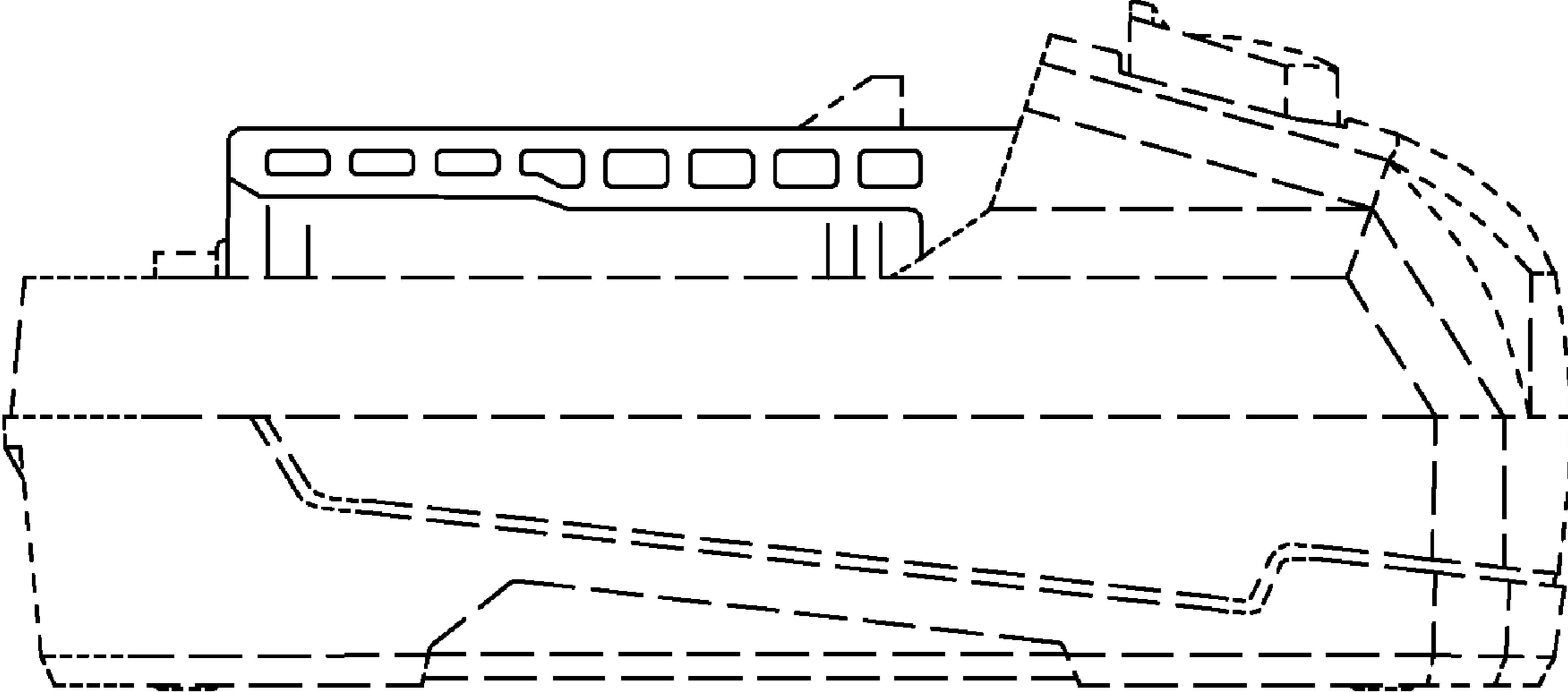

Fig. 1

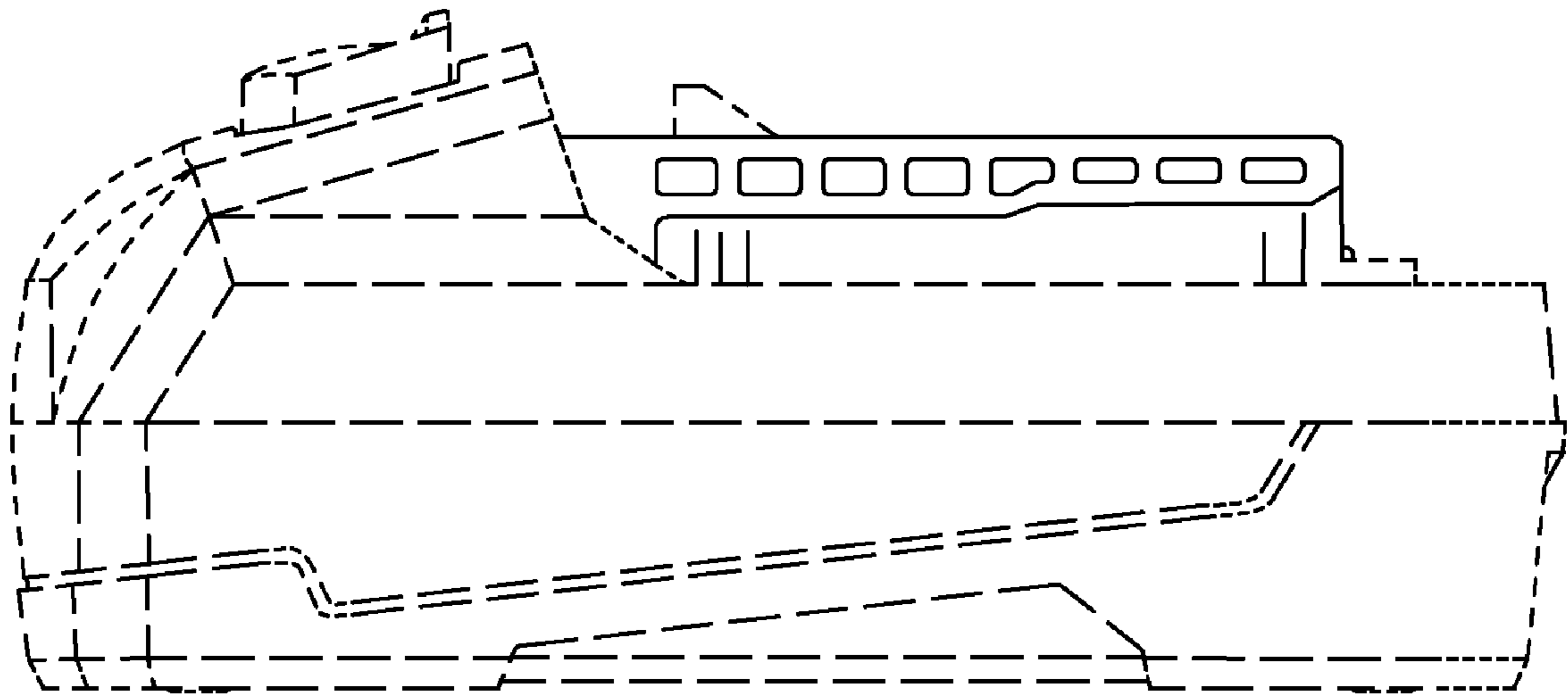

Fig. 2

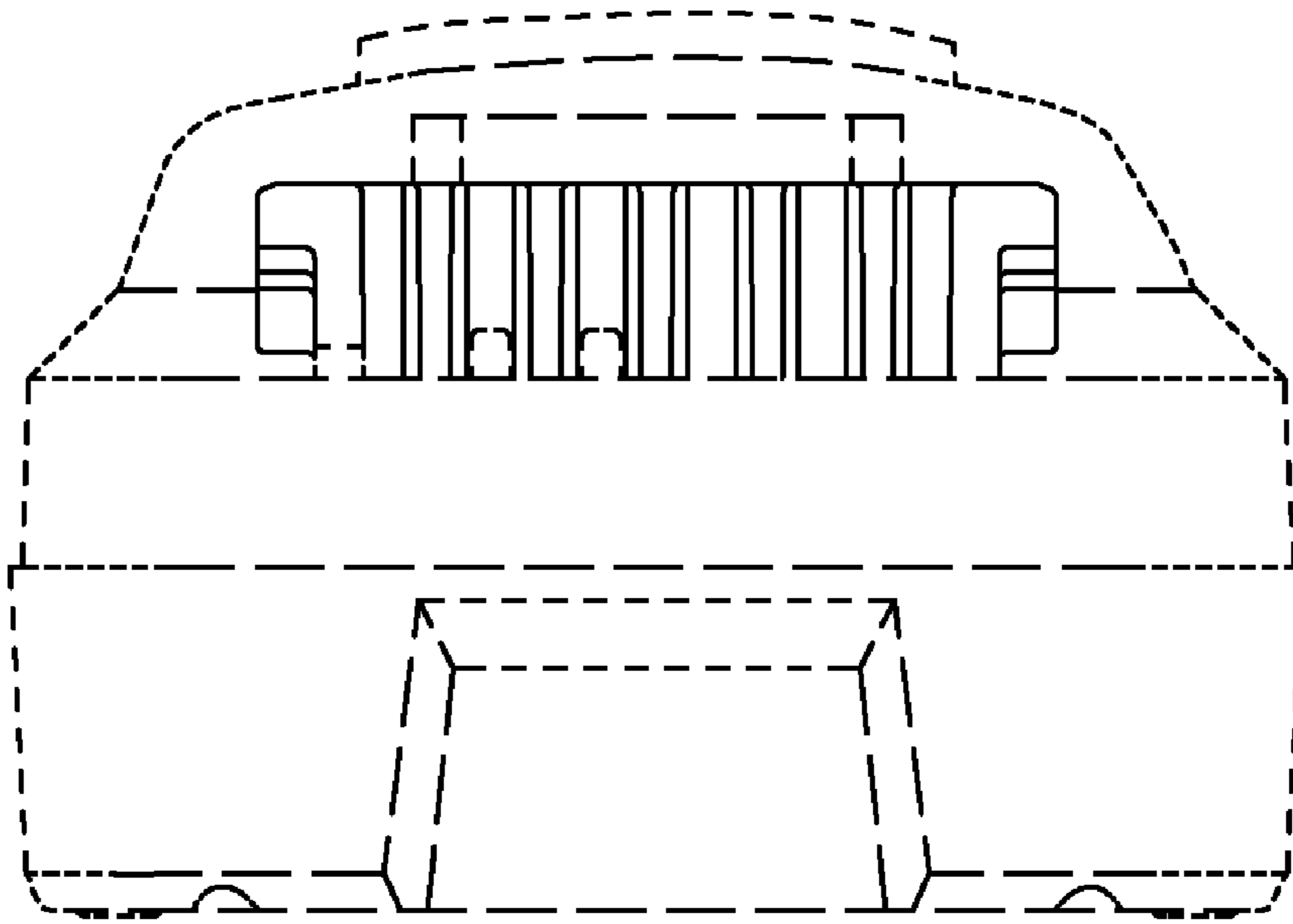

Fig. 3

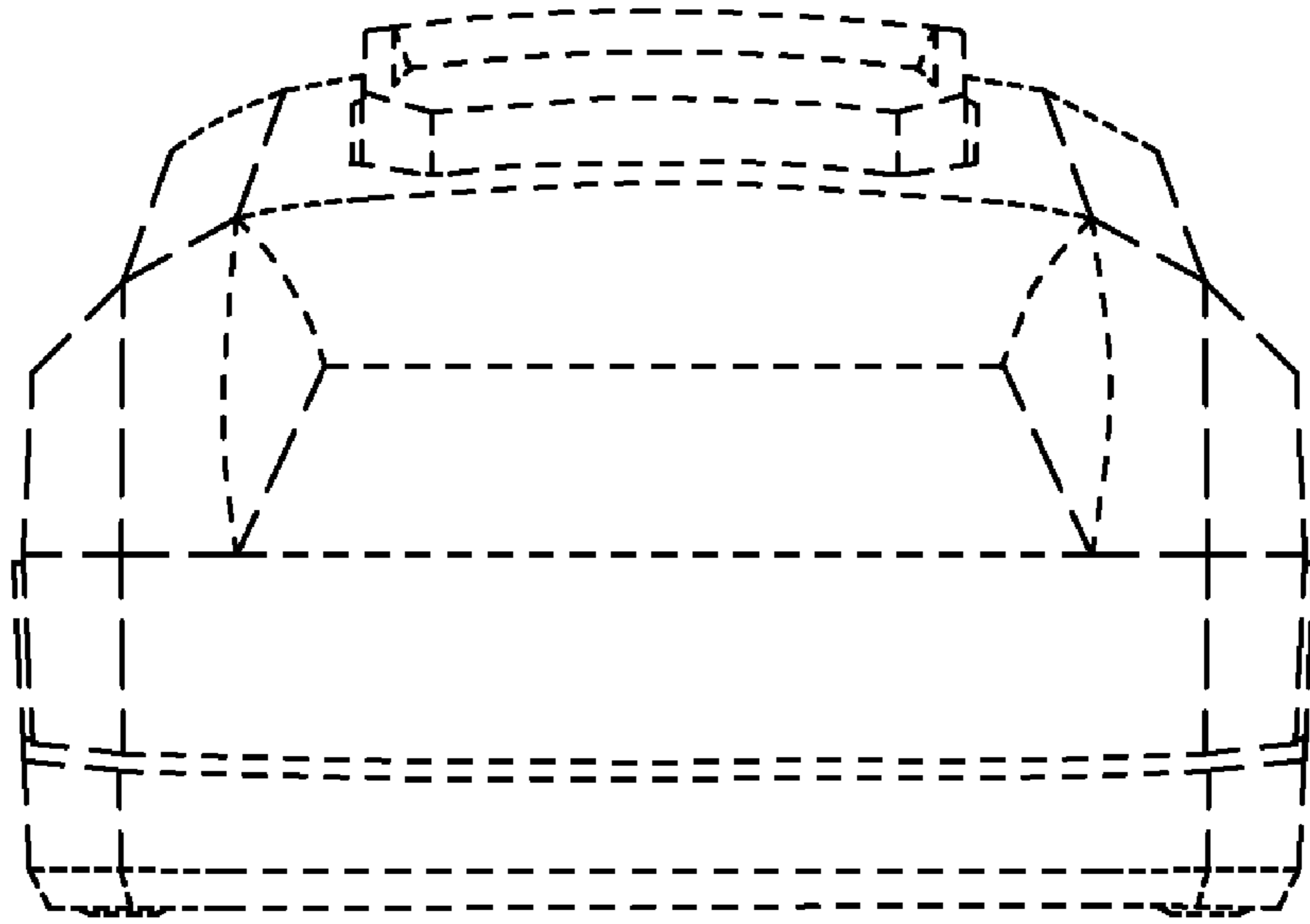

Fig. 4

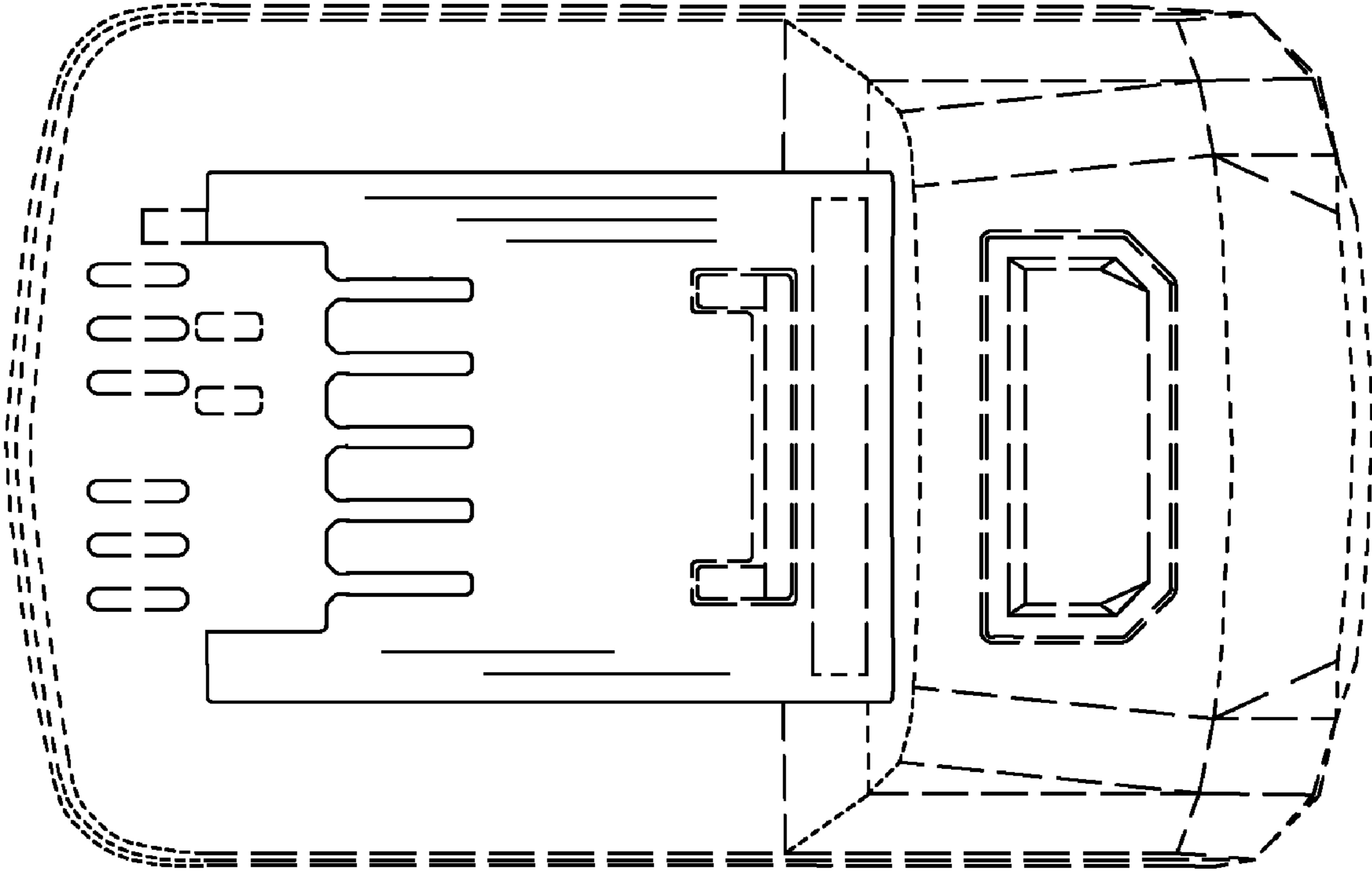

Fig. 5

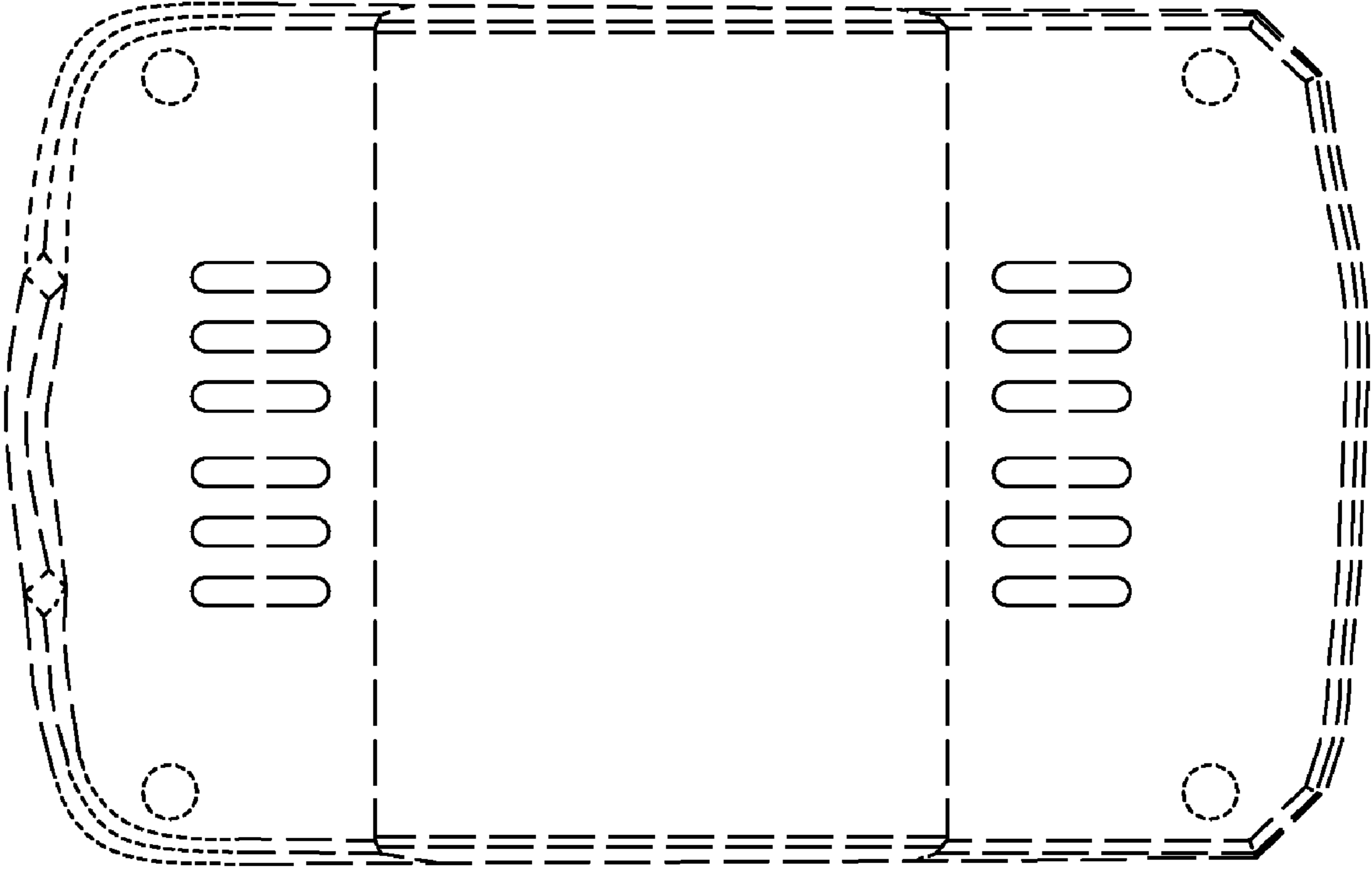

Fig. 6

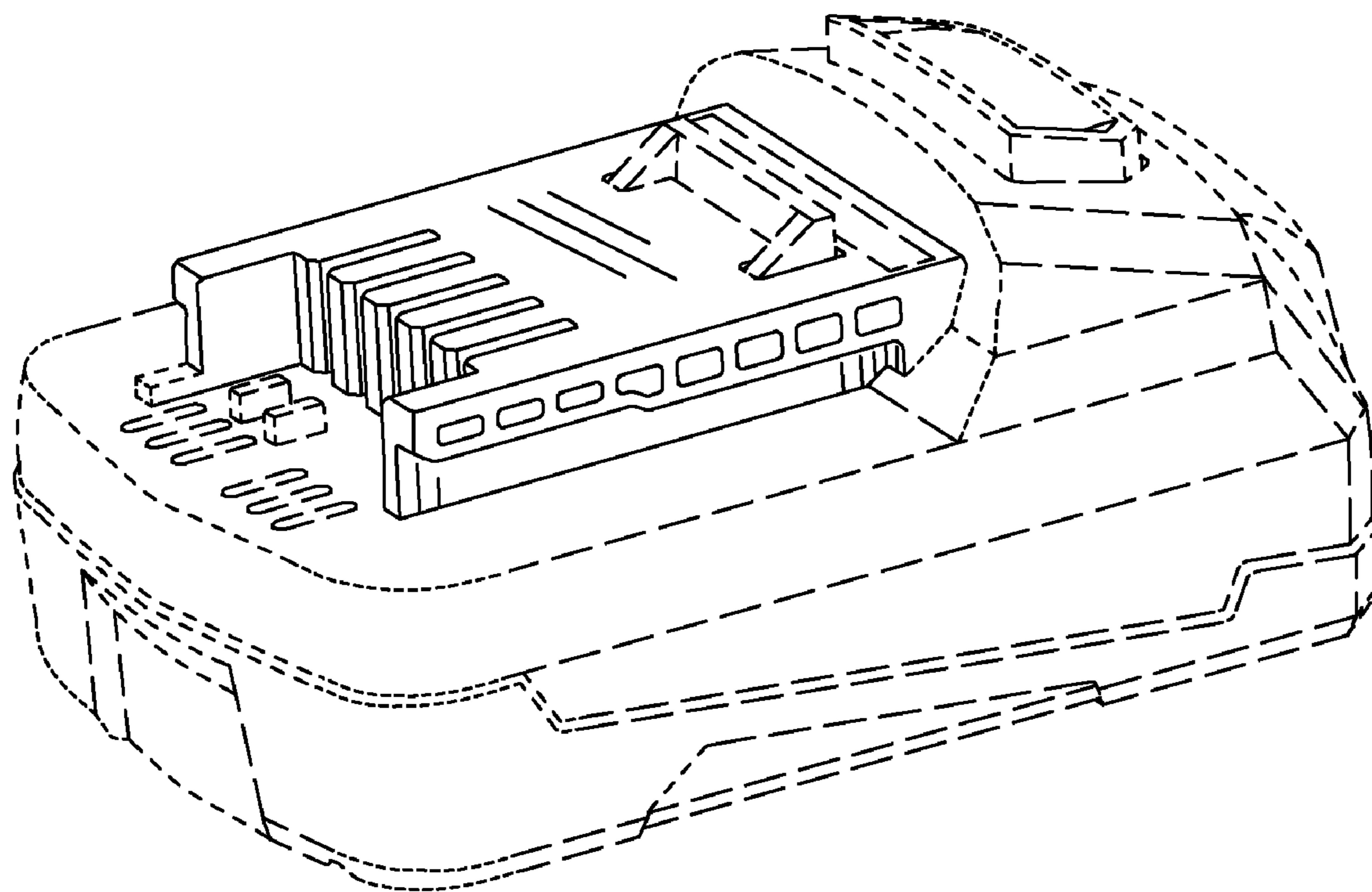

Fig. 7