



US00D640176S

(12) **United States Design Patent**  
**Hodges**

(10) **Patent No.:** **US D640,176 S**

(45) **Date of Patent:** **\*\* Jun. 21, 2011**

(54) **AUTOMOTIVE GRILLE**

(76) Inventor: **Frank J. Hodges**, Yorba Linda, CA (US)

(\*\*) Term: **14 Years**

(21) Appl. No.: **29/381,797**

(22) Filed: **Dec. 22, 2010**

*Primary Examiner* — Melody N Brown

(74) *Attorney, Agent, or Firm* — Knobbe, Martens, Olson & Bear, LLP

(57) **CLAIM**

The ornamental design for an automotive grille, as shown and described.

**Related U.S. Application Data**

(62) Division of application No. 29/345,993, filed on Oct. 23, 2009, now Pat. No. Des. 631,404.

(51) **LOC (9) Cl.** ..... **12-16**

(52) **U.S. Cl.** ..... **D12/163**

(58) **Field of Classification Search** ..... D12/163,  
D12/196, 171, 169, 216, 90-92, 86; 180/68.1,  
180/68.6; 296/193.11

See application file for complete search history.

(56) **References Cited**

**U.S. PATENT DOCUMENTS**

D488,111 S	4/2004	Elwell	
D546,247 S	7/2007	Abbett	
D570,264 S	6/2008	Spry	
D613,211 S	4/2010	Wu	
D613,212 S	4/2010	Wu	
D631,404 S *	1/2011	Hodges	..... D12/163

**OTHER PUBLICATIONS**

Truck grilles from at least as early as Oct. 22, 2008 in 3 pages downloaded from [www.rollingbigpower.com](http://www.rollingbigpower.com).

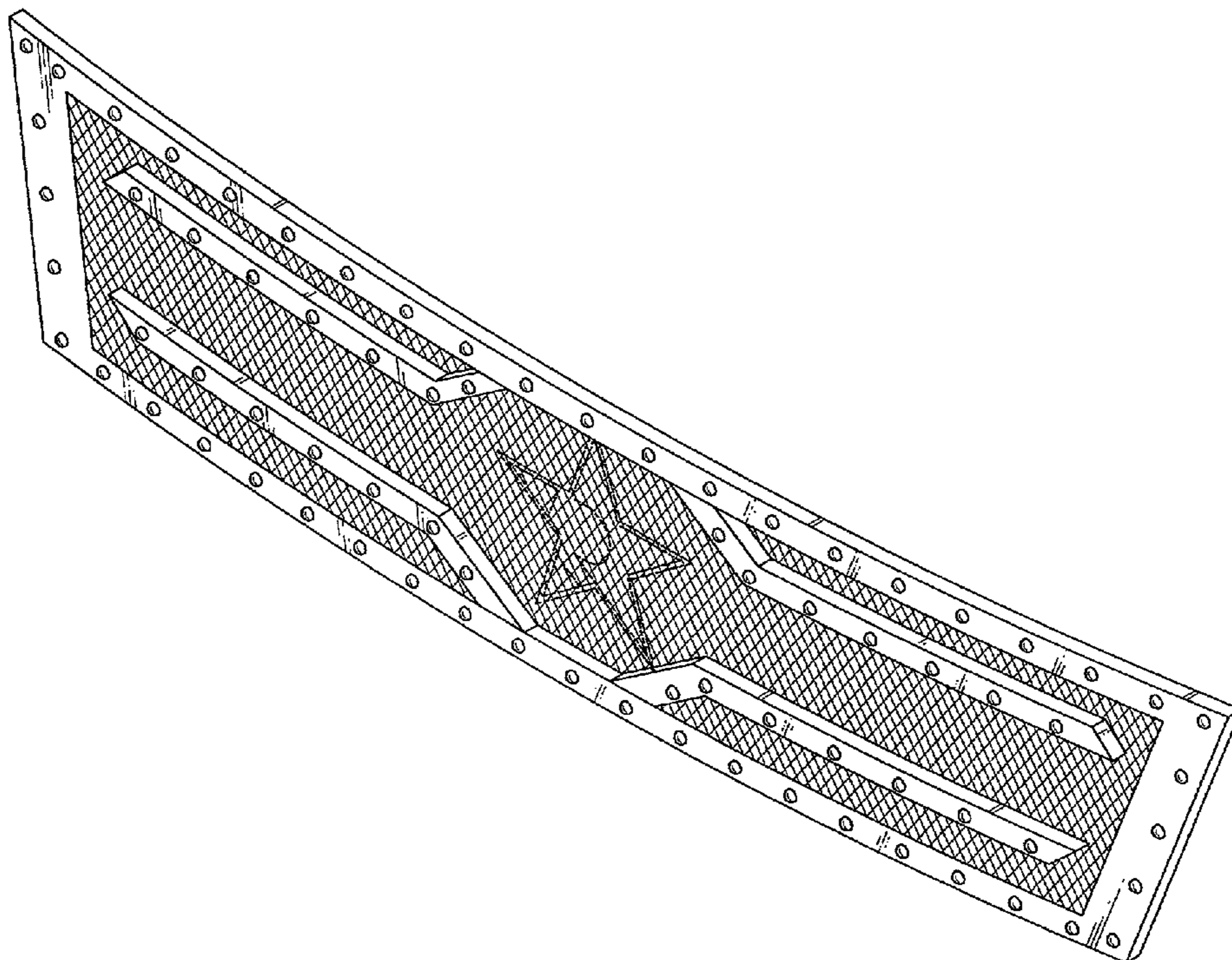
\* cited by examiner

**DESCRIPTION**

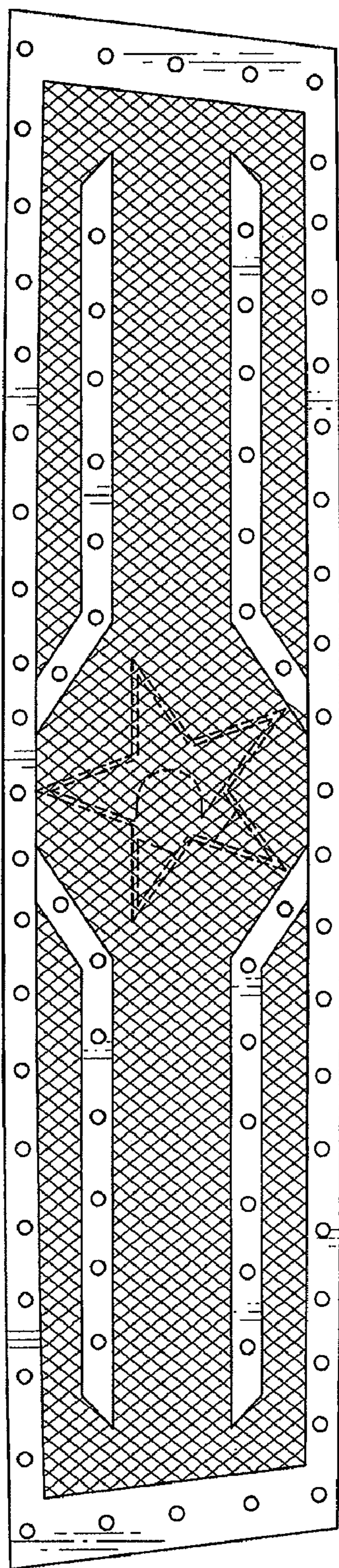
FIG. 1 is a front view of an automotive grille showing my new design;  
 FIG. 2 is a rear view thereof;  
 FIG. 3 is a top view thereof;  
 FIG. 4 is a bottom view thereof;  
 FIG. 5 is a left-side view thereof;  
 FIG. 6 is a right-side view thereof;  
 FIG. 7 is a perspective view thereof;  
 FIG. 8 is a front view of an automotive grille showing a second embodiment of my new design;  
 FIG. 9 is a rear view of FIG. 8;  
 FIG. 10 is a top view of FIG. 8;  
 FIG. 11 is a bottom view of FIG. 8;  
 FIG. 12 is a left-side view of FIG. 8;  
 FIG. 13 is a right-side view of FIG. 8; and,  
 FIG. 14 is a perspective view of FIG. 8.

The portions shown in phantom provide context only but do not limit the claim and should not be considered part of the claimed design.

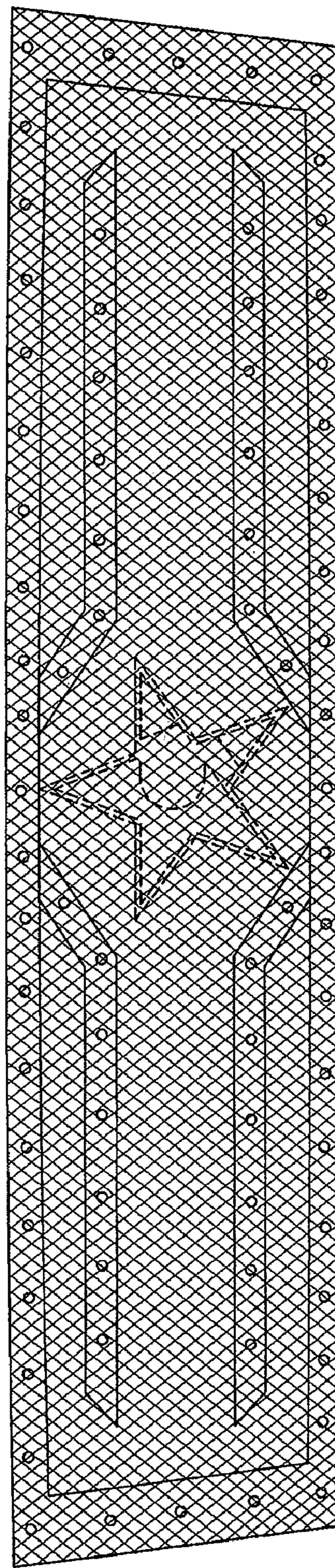
**1 Claim, 6 Drawing Sheets**





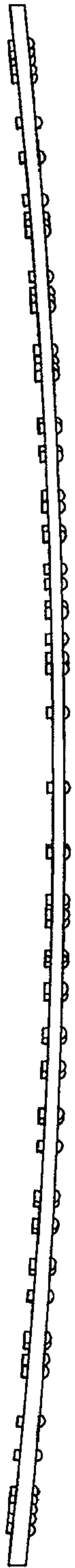


**FIG. 1**

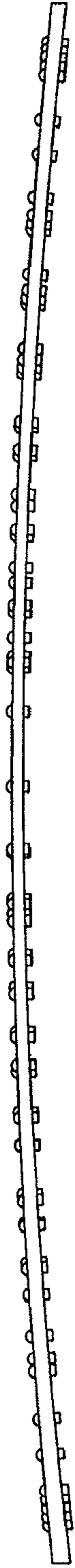


**FIG. 2**

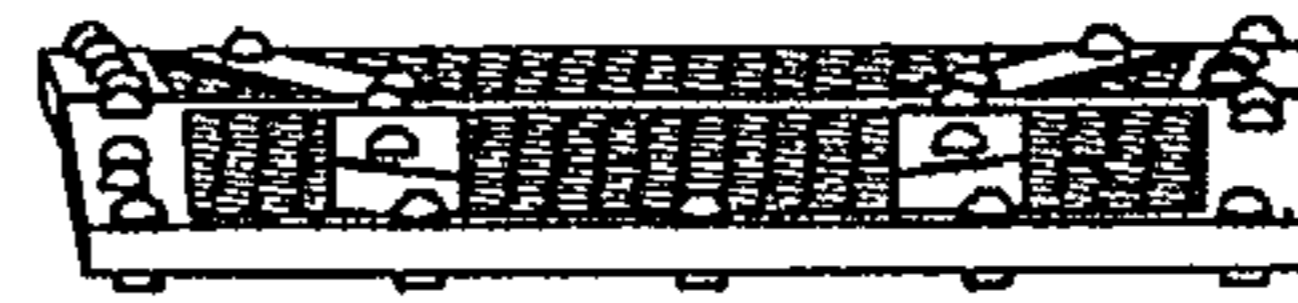




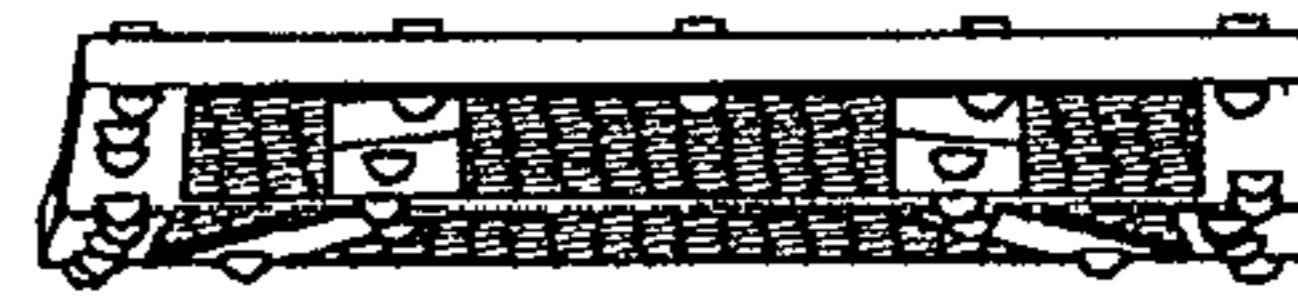
**FIG. 3**



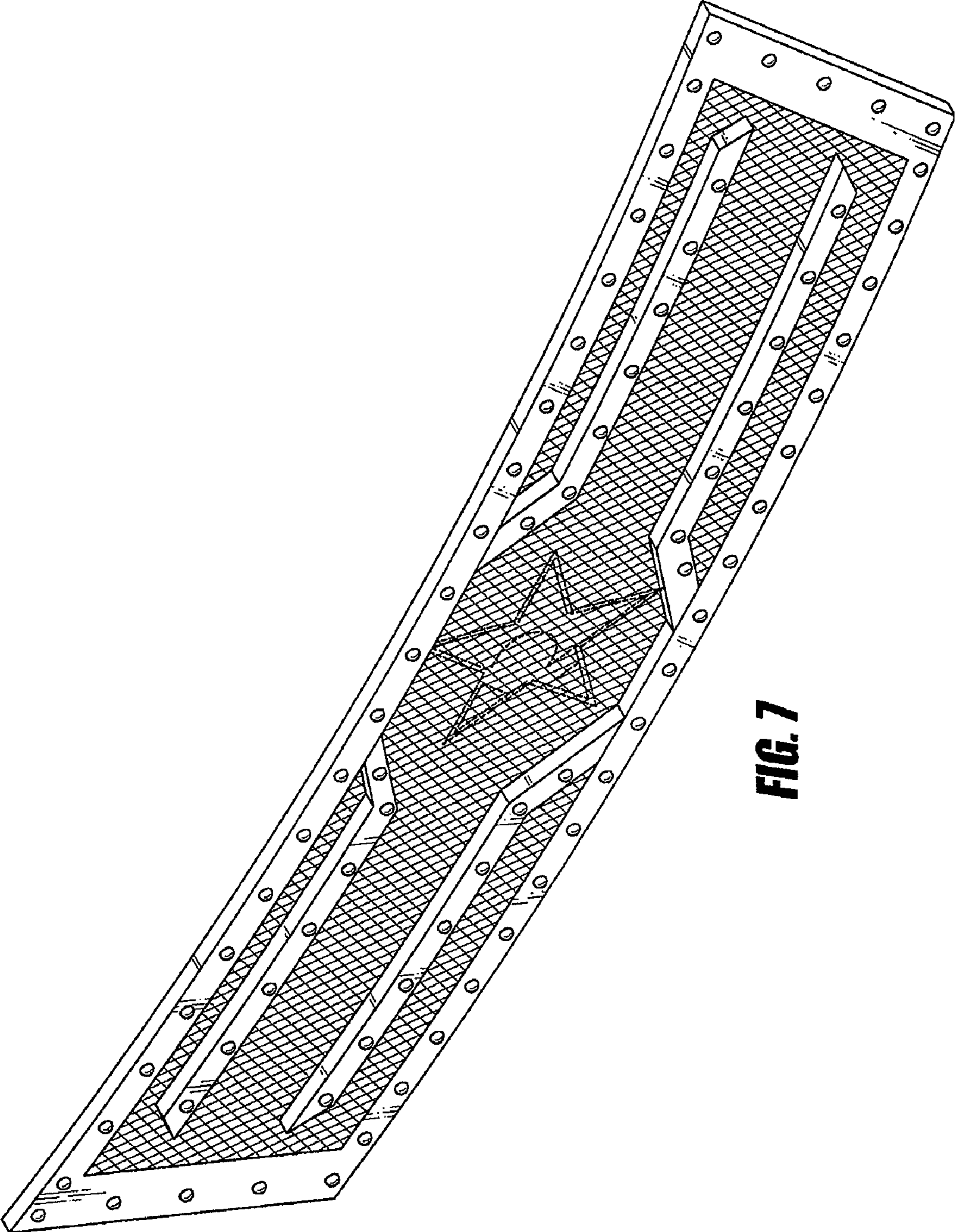
**FIG. 4**



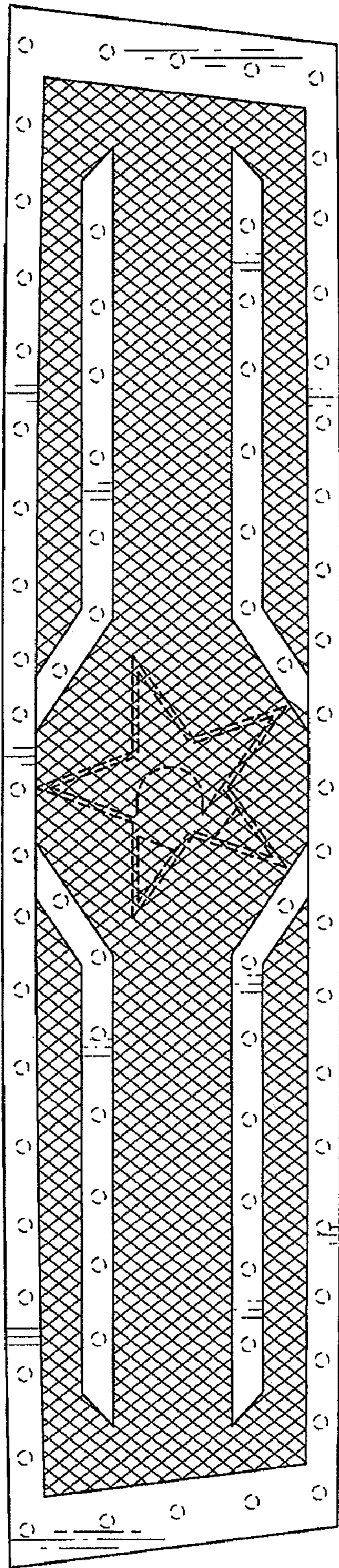
**FIG. 5**



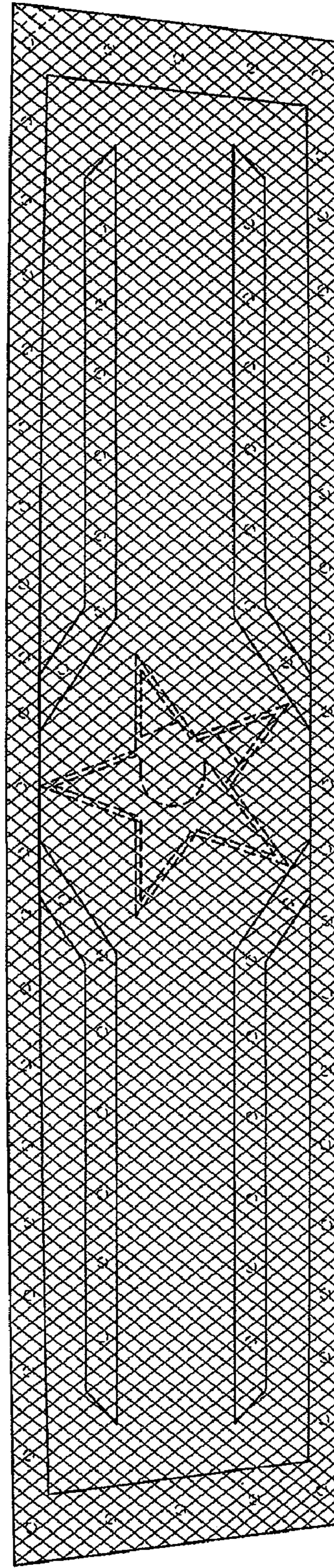
**FIG. 6**







**FIG. 8**



**FIG. 9**





**FIG. 10**



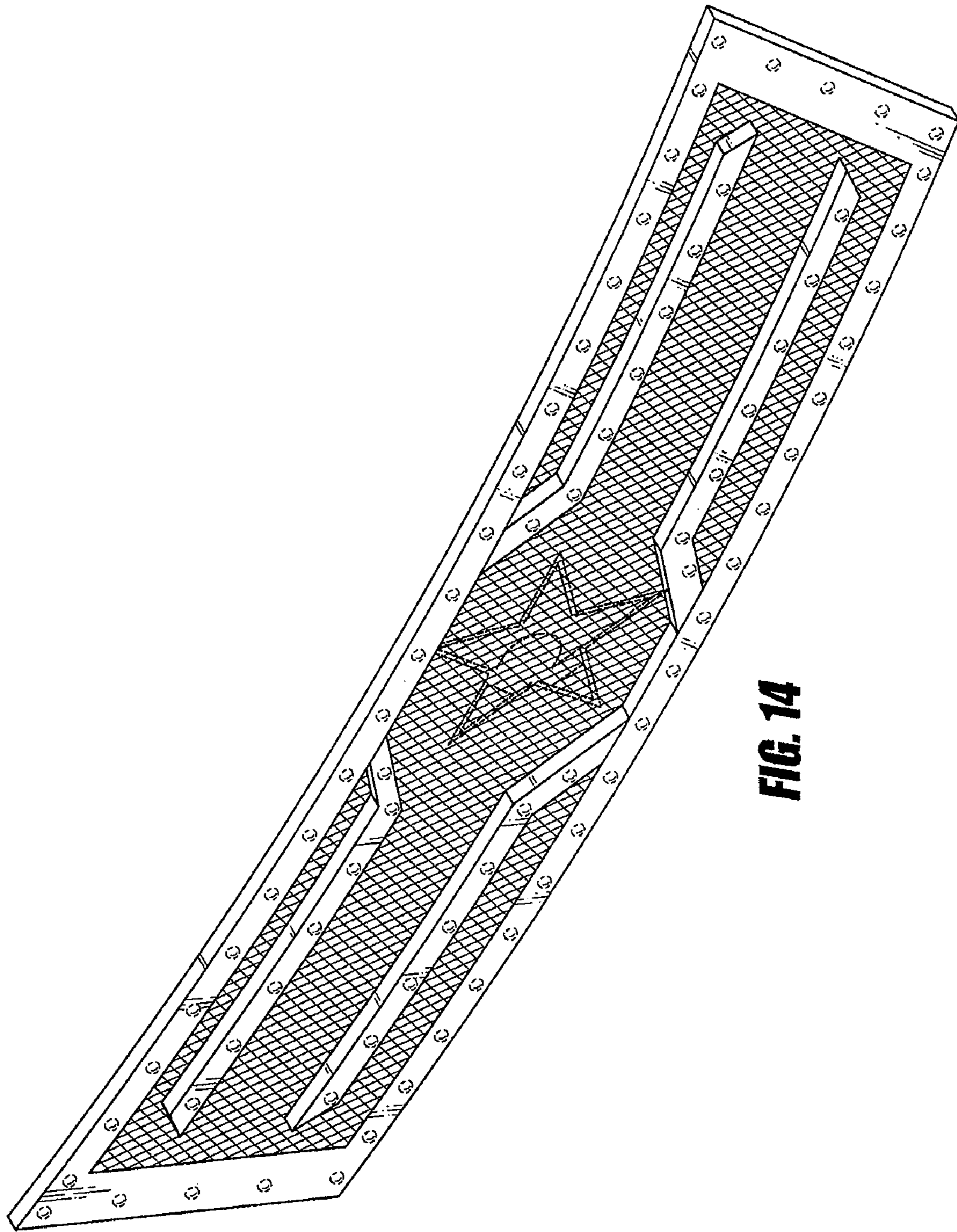
**FIG. 11**



**FIG. 12**



**FIG. 13**



**FIG. 14**