



US00D640137S

(12) **United States Design Patent**
Martone

(10) **Patent No.:** **US D640,137 S**

(45) **Date of Patent:** **** Jun. 21, 2011**

(54) **PERFUME BOTTLE**

(75) Inventor: **Giorgia Martone**, Milan (IT)

(73) Assignee: **I.C.R. Industrie Cosmetiche Riunite S.p.A.**, Milan (IT)

(**) Term: **14 Years**

(21) Appl. No.: **29/352,792**

(22) Filed: **Dec. 28, 2009**

(30) **Foreign Application Priority Data**

Jun. 30, 2009 (EM) 001565367-0001

(51) **LOC (9) Cl.** **09-01**

(52) **U.S. Cl.** **D9/559**; D9/452; D9/563; D9/564;
D9/569; D9/571

(58) **Field of Classification Search** D9/434,
D9/435, 452, 453, 454, 516, 520, 529, 537,
D9/538, 539, 545, 546, 549, 550, 551, 556,
D9/558, 563, 564, 559, 569, 571, 574, 682,
D9/686, 688, 690; 215/381-385; 220/600,
220/660, 669, 675

See application file for complete search history.

(56) **References Cited**

U.S. PATENT DOCUMENTS

D42,441 S *	4/1912	Sanford	D7/597
D43,781 S *	4/1913	Sanford	D7/597
D50,414 S *	3/1917	Vilbiss	D7/597
D50,467 S *	3/1917	Vibis	D7/597
D57,147 S *	2/1921	Ohkr	D9/546
D59,071 S *	9/1921	Duke	D9/544
D64,125 S *	3/1924	Miller	D9/556
D75,460 S *	6/1928	Ansell	D9/559
D98,396 S *	1/1936	Gray	D9/545
D102,674 S *	1/1937	Bireley	D9/538
D114,557 S *	5/1939	Nitardy	D9/559
D127,618 S *	6/1941	Fuerst	D9/556

D176,487 S *	12/1955	Sherman	D9/556
D202,222 S *	9/1965	Heintze	D9/546
3,923,178 A *	12/1975	Welker, III	215/381
D264,685 S *	6/1982	Ducros	D9/556
4,749,092 A *	6/1988	Sugiura et al.	215/381
D353,776 S *	12/1994	Woods	D9/553
D370,634 S *	6/1996	Mero et al.	D9/538
D384,586 S *	10/1997	Peek	D9/520
D437,233 S *	2/2001	Gibert	D9/556
D464,572 S *	10/2002	Markus	D9/569
6,662,960 B2 *	12/2003	Hong et al.	215/381
D542,136 S *	5/2007	Lilico	D9/520
D574,716 S *	8/2008	Kruparova	D9/542
D581,803 S *	12/2008	Lepoitevin	D9/556
D586,657 S *	2/2009	Pritchett, Jr.	D9/539
D586,658 S *	2/2009	Pritchett, Jr.	D9/539
2002/0000421 A1 *	1/2002	Ota et al.	215/381

* cited by examiner

Primary Examiner — Stella M Reid

Assistant Examiner — Elizabeth J Oswecki

(74) *Attorney, Agent, or Firm* — Abelman, Frayne & Schwab

(57) **CLAIM**

The ornamental design for a perfume bottle, as shown and described.

DESCRIPTION

FIG. 1 is a top, perspective view of a perfume bottle showing my new design;

FIG. 2 is a front perspective view thereof;

FIG. 3 is a front elevational view thereof;

FIG. 4 is a rear elevational view thereof;

FIG. 5 is a left elevational view thereof;

FIG. 6 is a right elevational view thereof; and,

FIG. 7 is a top plan view thereof.

The broken line showing of a spray pump are included for the purpose of illustration only and forms no part of the claimed design.

1 Claim, 3 Drawing Sheets

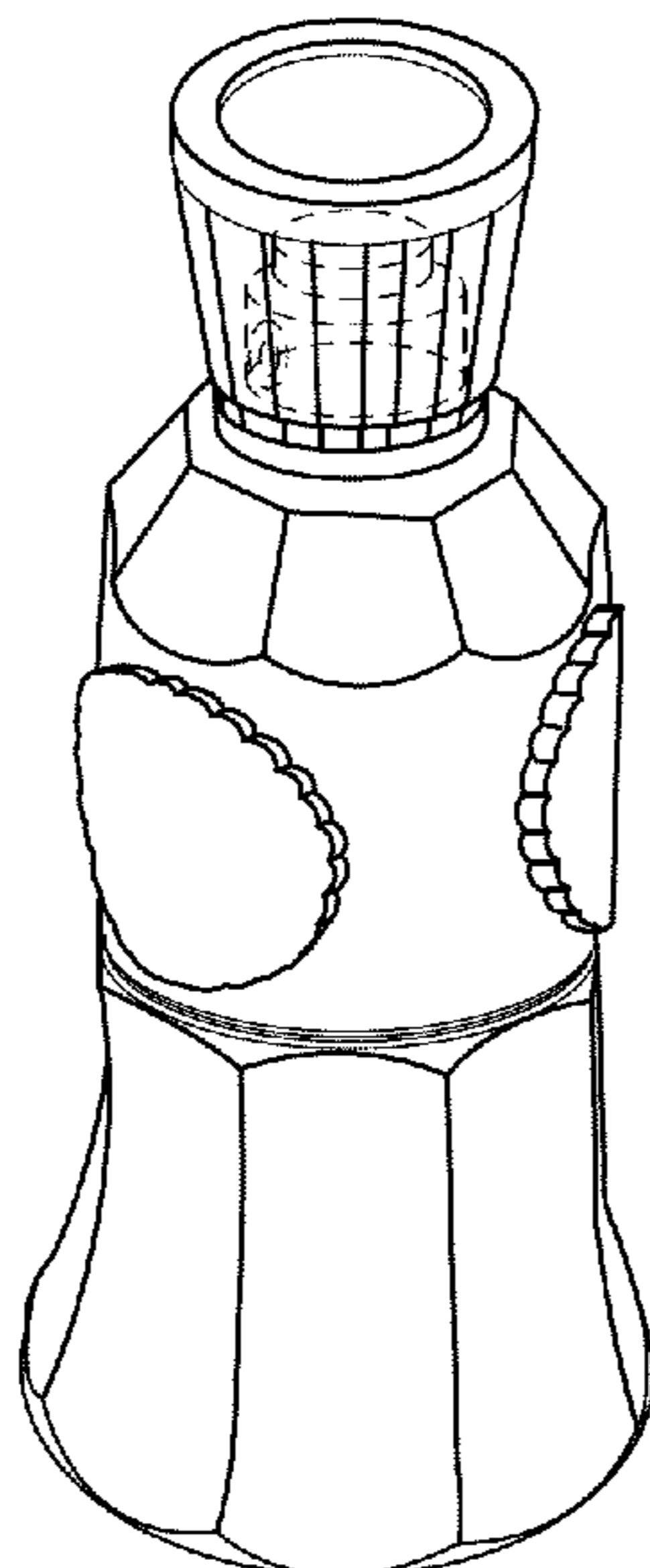

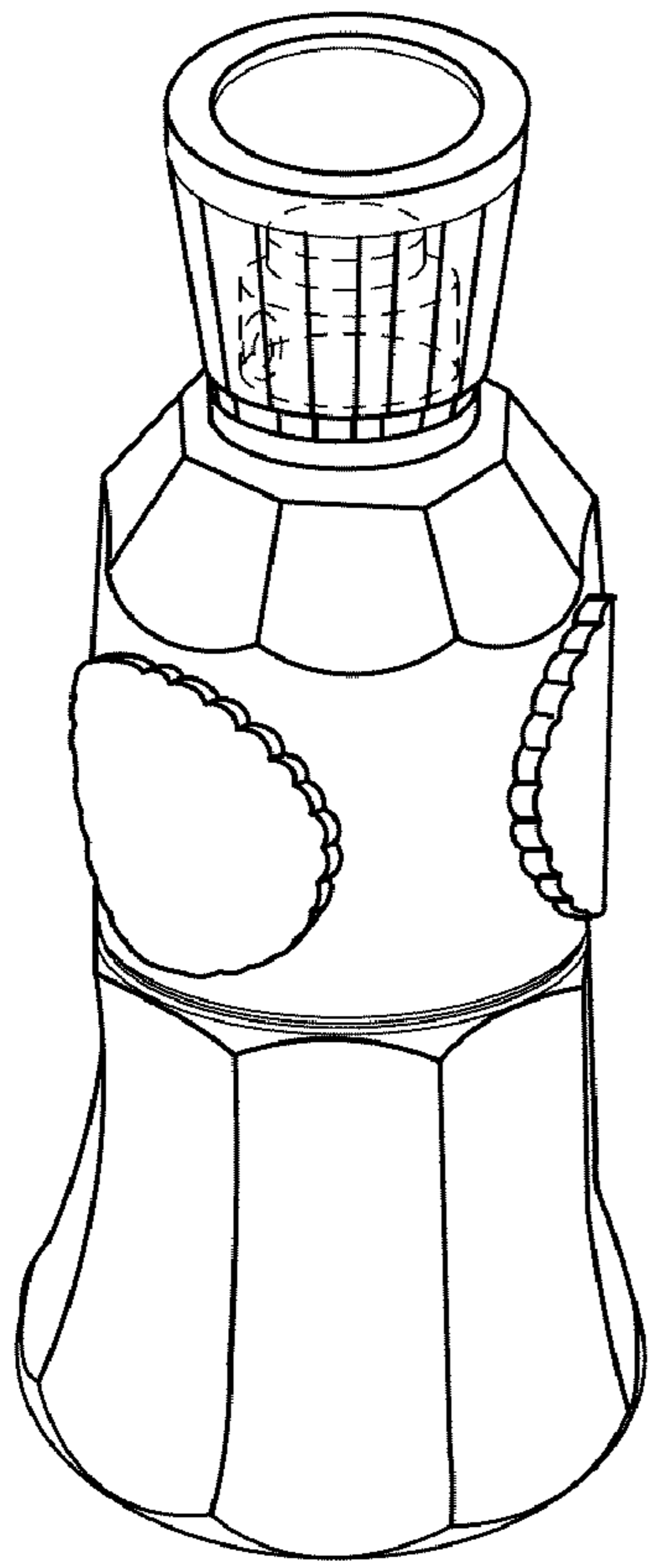

FIG. 1

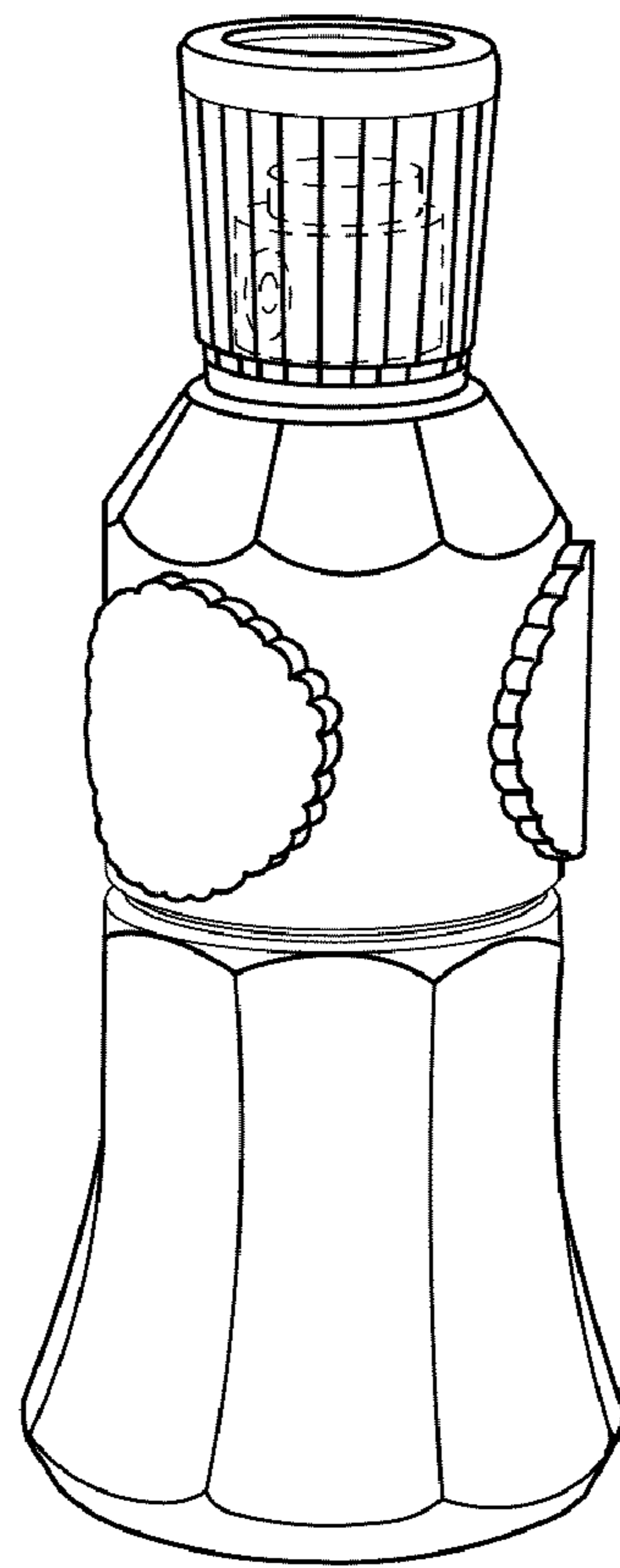

FIG. 2

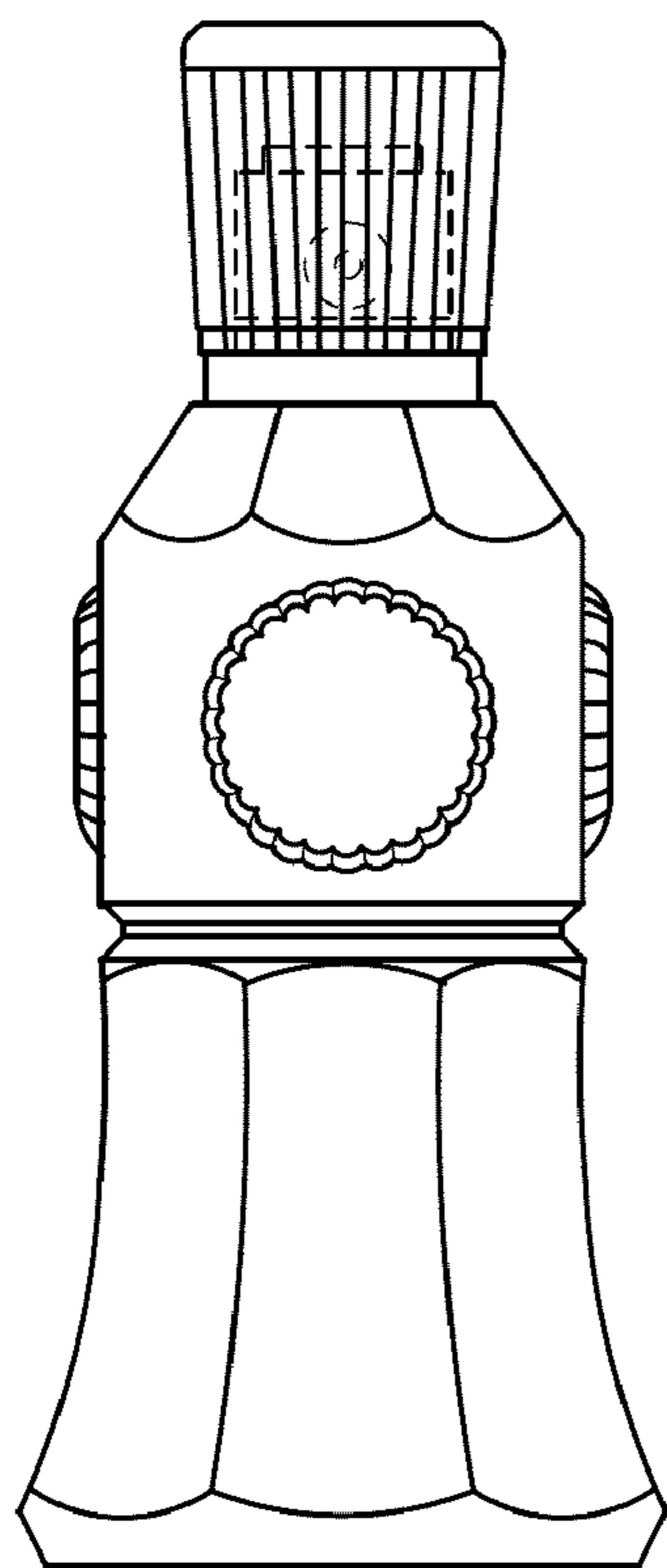

FIG. 3

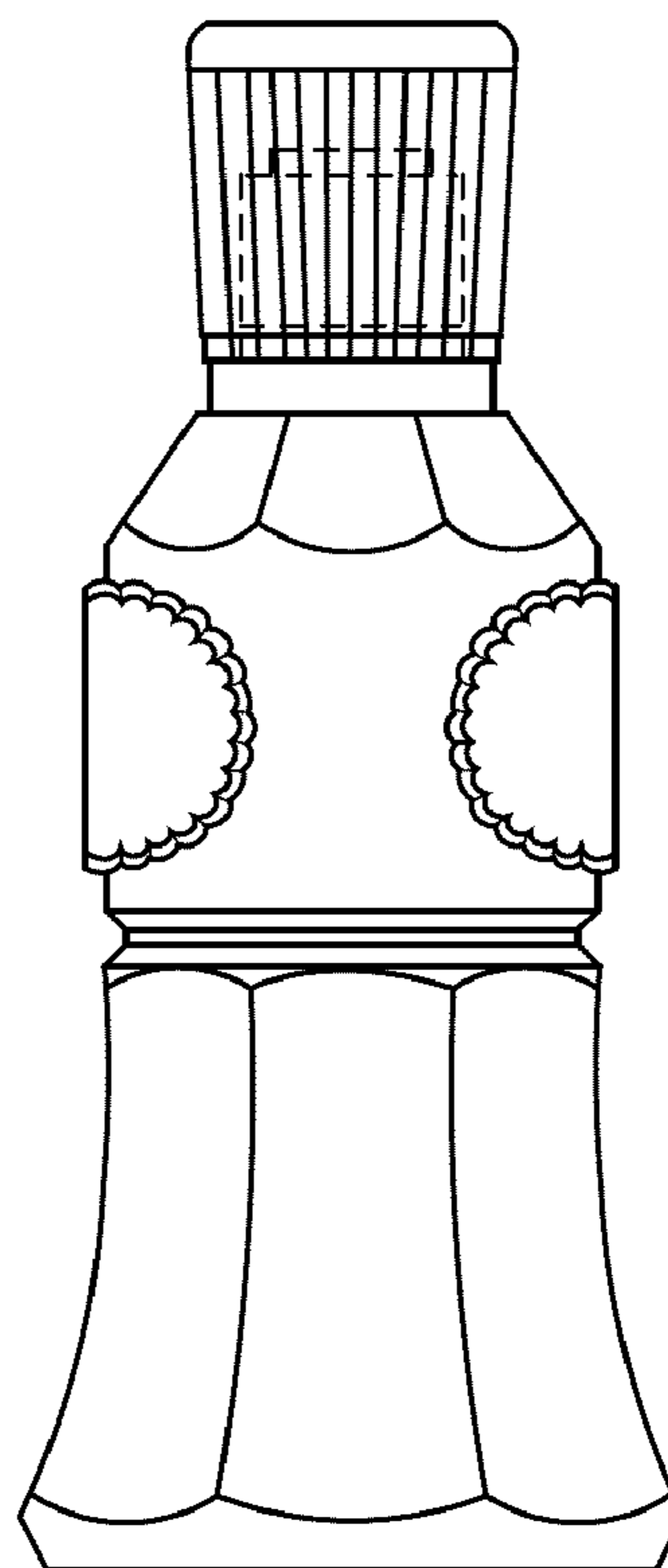

FIG. 4

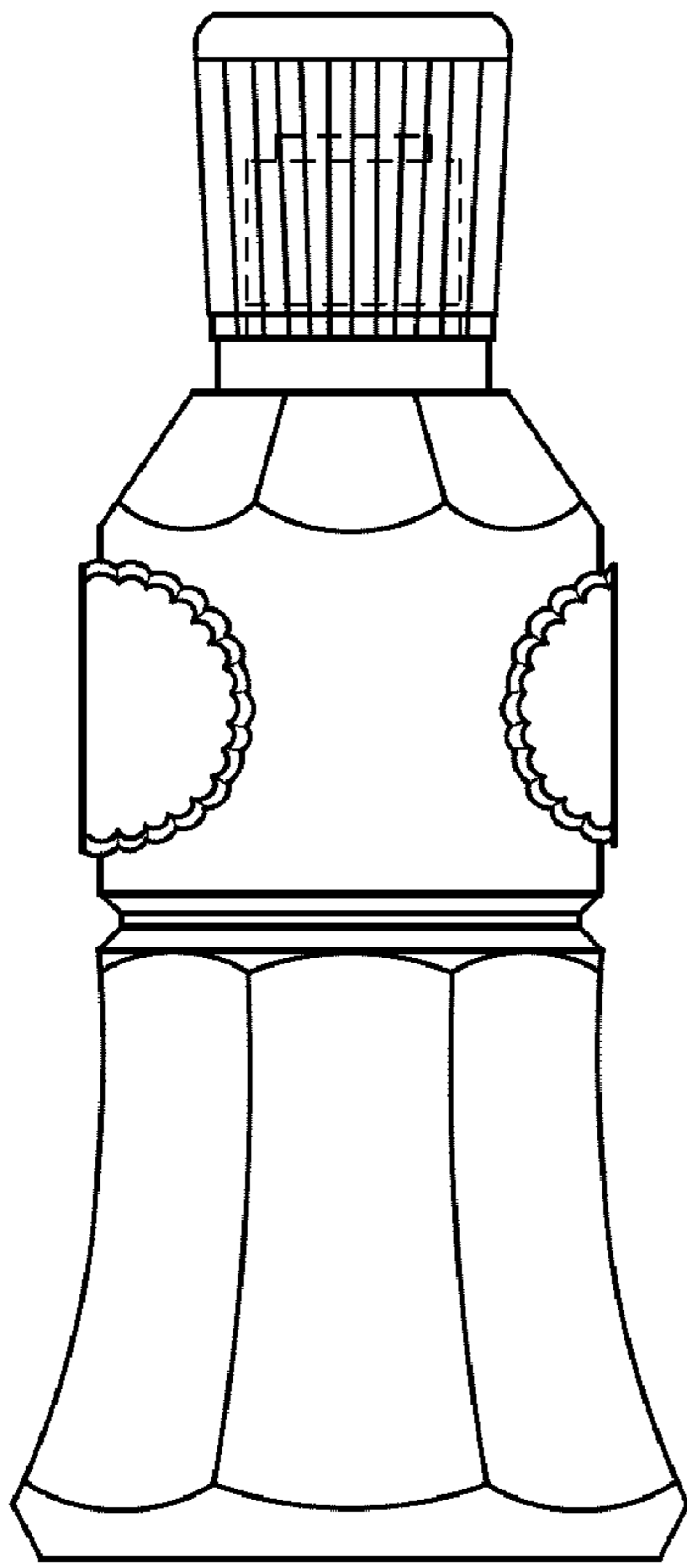

FIG. 5

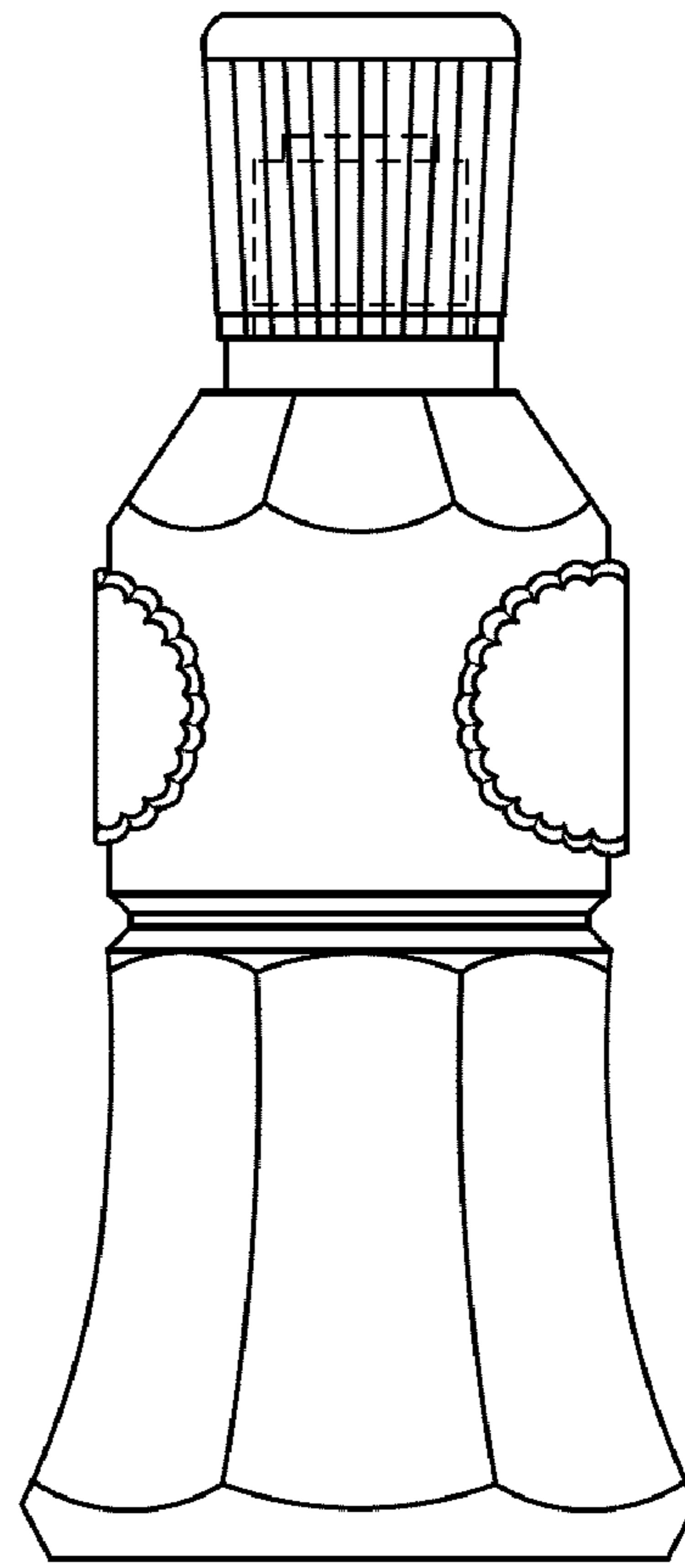

FIG. 6

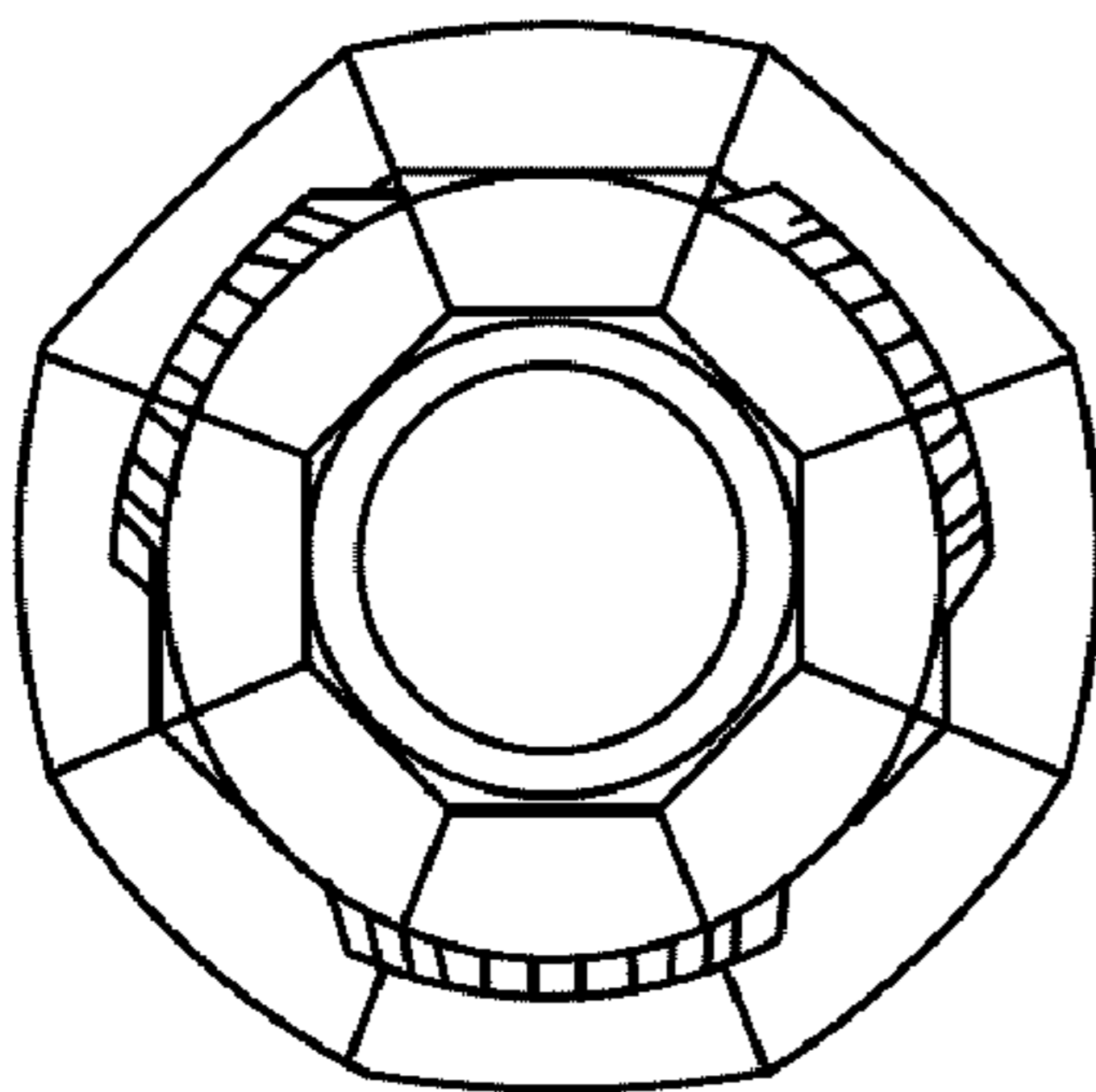

FIG. 7