



US00D639978S

(12) **United States Design Patent**  
**Roos et al.**

(10) **Patent No.:** **US D639,978 S**  
(45) **Date of Patent:** **\*\* Jun. 14, 2011**

(54) **HEMATOLOGY TEST CASSETTE WITH  
PREFILLED REAGENTS**

(75) Inventors: **Björn Roos**, Stockholm (SE); **Lennart  
Niklasson**, Sollentuna (SE)

(73) Assignee: **Boule Medical AB**, Stockholm (SE)

(\*\*) Term: **14 Years**

(21) Appl. No.: **29/332,999**

(22) Filed: **Mar. 2, 2009**

**Related U.S. Application Data**

(63) Continuation-in-part of application No. 12/270,083,  
filed on Nov. 13, 2008.

(51) **LOC (9) Cl.** ..... **24-02**

(52) **U.S. Cl.** ..... **D24/227; D24/169**

(58) **Field of Classification Search** ..... D24/111,  
D24/108, 107, 169, 216, 223–232; 604/153,  
604/30, 34, 113, 82, 114; 417/474; 422/1,  
422/61, 68.1, 99–104, 129; 600/300, 301,  
600/368, 372, 481, 529, 544, 554, 561  
See application file for complete search history.

(56) **References Cited**

**U.S. PATENT DOCUMENTS**

D305,150	S	*	12/1989	Pastrone	.....	D24/111
D331,799	S	*	12/1992	Kramer et al.	.....	D24/111
D350,823	S	*	9/1994	Lanigan	.....	D24/111
D398,051	S	*	9/1998	Lanigan et al.	.....	D24/108
D556,909	S	*	12/2007	Reihanifam et al.	.....	D24/169
7,335,339	B2		2/2008	Berndtsson		
D576,281	S	*	9/2008	Reihanifam et al.	.....	D24/169
D579,553	S	*	10/2008	Crnkovich et al.	.....	D24/111
D615,189	S	*	5/2010	McGill et al.	.....	D24/111
D615,190	S	*	5/2010	McGill	.....	D24/111
D616,539	S	*	5/2010	McGill	.....	D24/111
2010/0120083	A1		5/2010	Ritzen		

**FOREIGN PATENT DOCUMENTS**

WO 2004/045770 6/2004

\* cited by examiner

*Primary Examiner* — T. Chase Nelson

*Assistant Examiner* — Mark Cavanna

(74) *Attorney, Agent, or Firm* — Greenblum & Bernstein,  
P.L.C.

(57) **CLAIM**

The ornamental design for a hematology test cassette with  
prefilled reagents, as shown and described.

**DESCRIPTION**

FIG. 1 is a perspective view of a hematology test cassette with  
prefilled reagents showing an embodiment of the new design,  
the cassette being translucent and having transparent dia-  
phragms covering an upper surface and a bottom surface of  
the cassette, respectively;

FIG. 2 is a top plan view of the cassette shown in FIG. 1;

FIG. 3 is a bottom plan view of the cassette shown in FIG. 1;

FIG. 4 is a front elevational view of the cassette shown in FIG.  
1;

FIG. 5 is a rear elevational view of the cassette shown in FIG.  
1;

FIG. 6 is a left side elevational view of the cassette shown in  
FIG. 1;

FIG. 7 is a right side elevational view of the cassette shown in  
FIG. 1;

FIG. 8 is a perspective view of the hematology test cassette  
with prefilled reagents showing another embodiment of the  
new design, the cassette being non-translucent and having  
non-transparent diaphragms covering the upper surface and  
the bottom surface of the cassette, respectively;

FIG. 9 is a top plan view of the cassette shown in FIG. 8;

FIG. 10 is a bottom plan view of the cassette shown in FIG. 8;

FIG. 11 is a front elevational view of the cassette shown in FIG.  
8;

FIG. 12 is a rear elevational view of the cassette shown in FIG.  
8;

FIG. 13 is a left side elevational view of the cassette shown in  
FIG. 8; and,

FIG. 14 is a right side elevational view of the cassette shown  
in FIG. 8.

The broken lines are included for the purpose of illustrating  
portions of the hematology test cassette with prefilled  
reagents that forms no part of the claimed design.

**1 Claim, 6 Drawing Sheets**

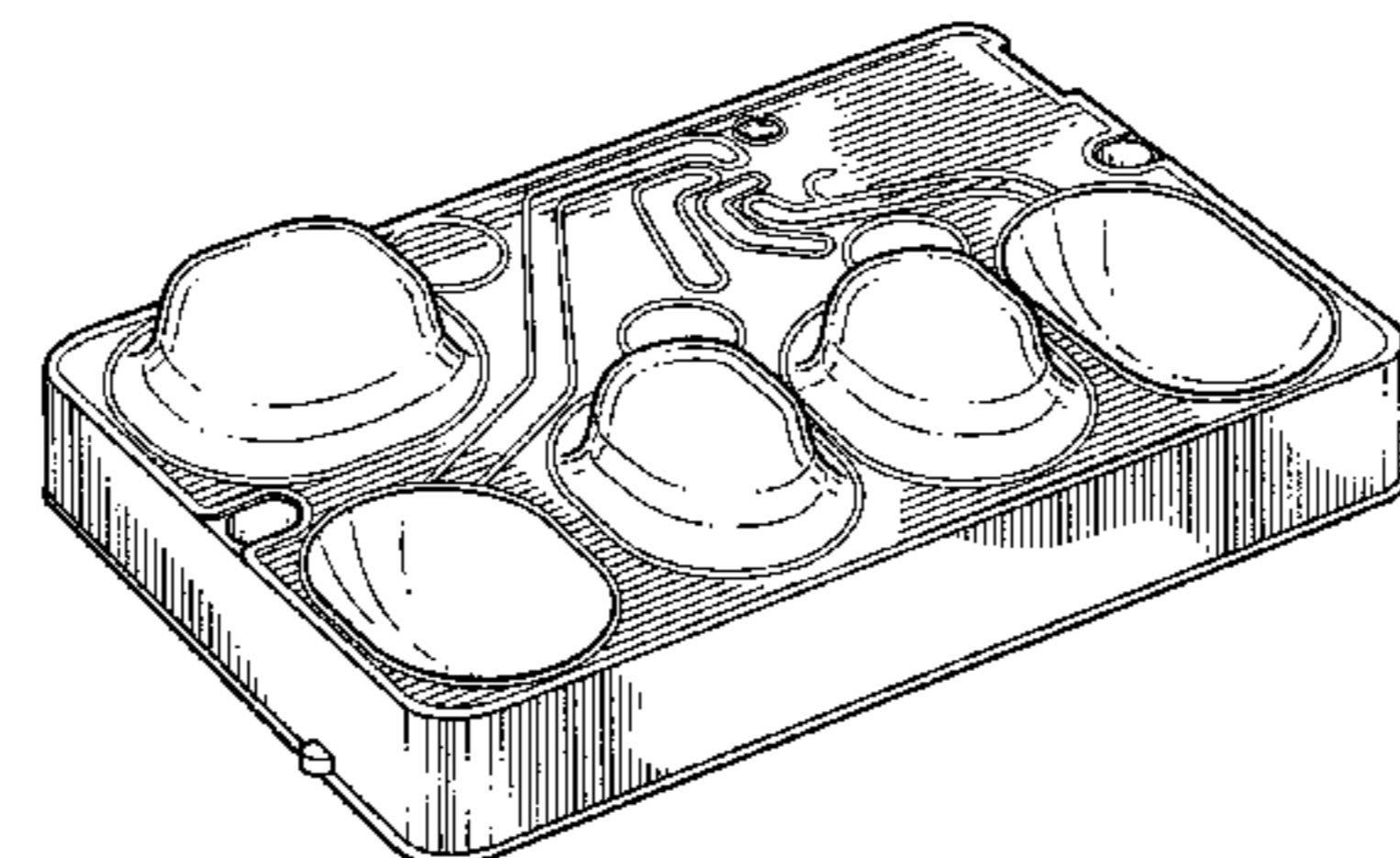
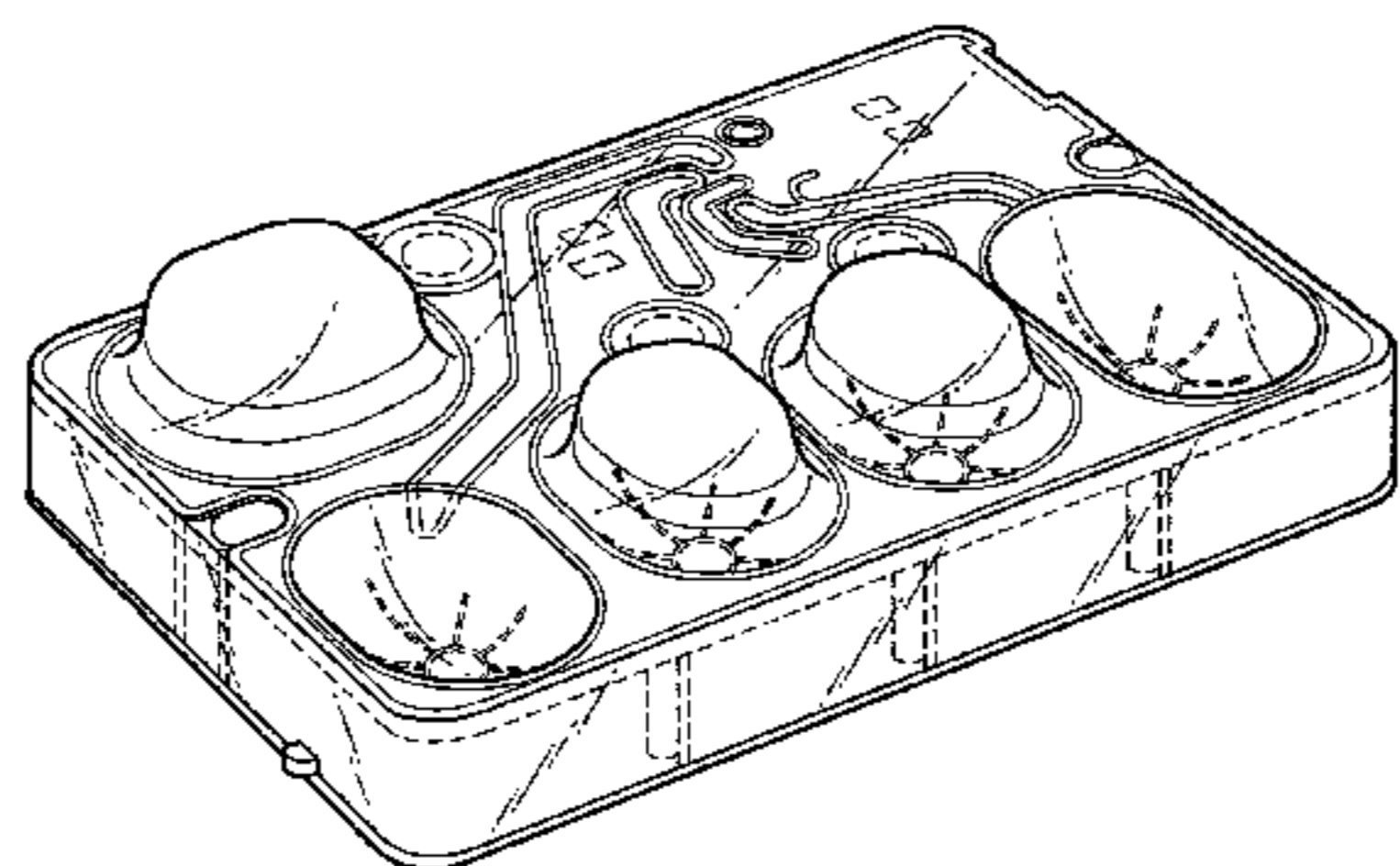

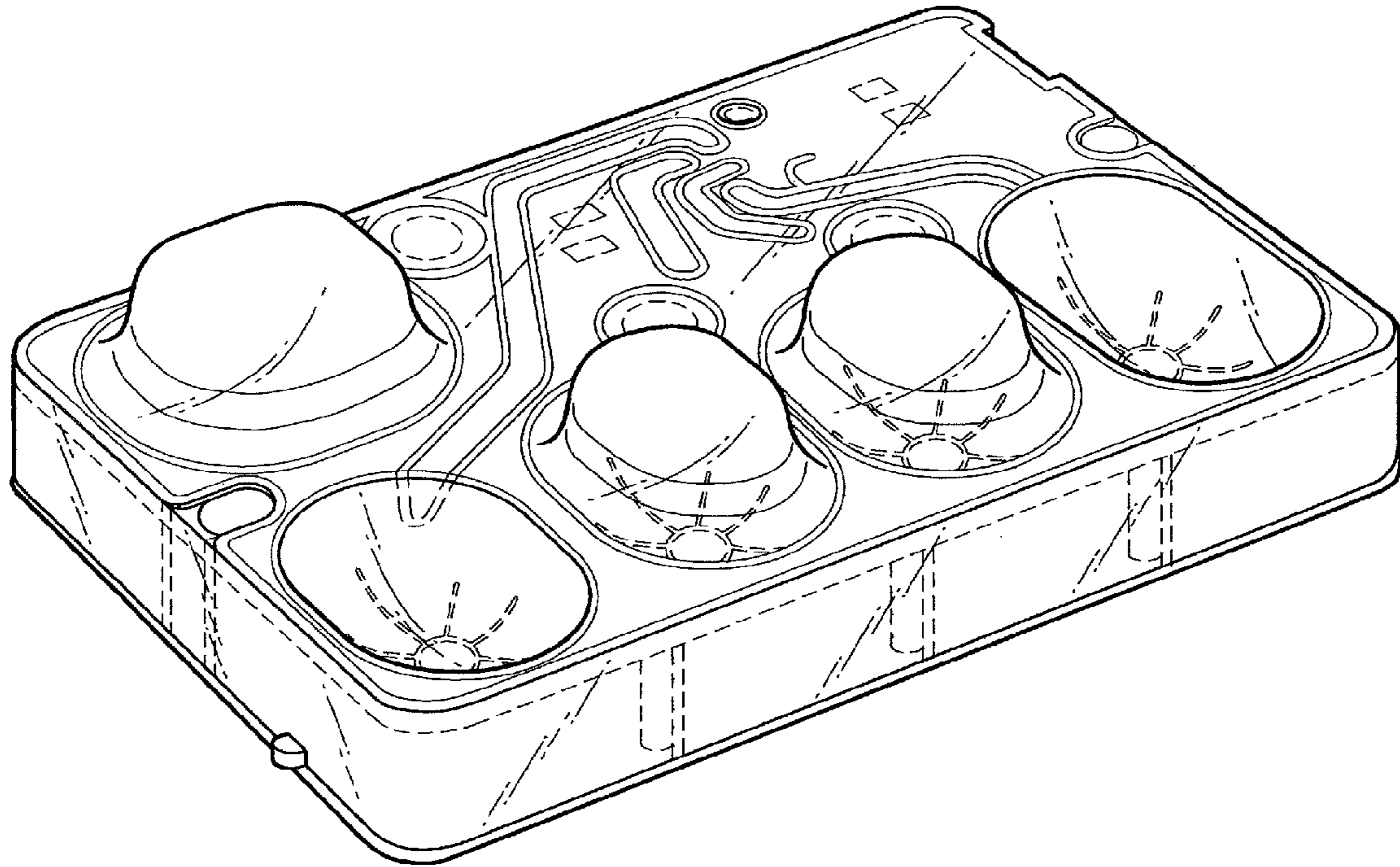

FIG. 1

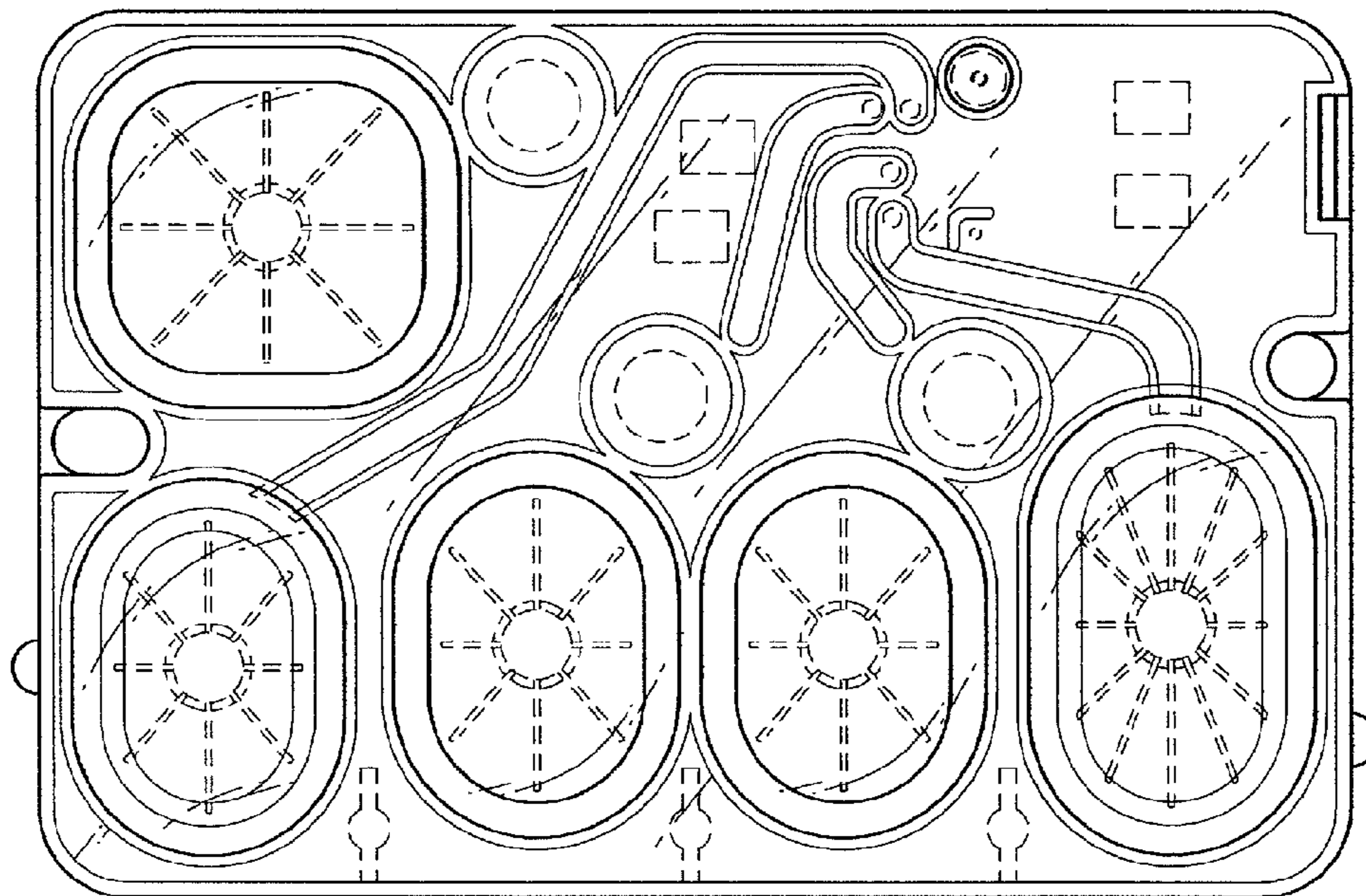

FIG. 2

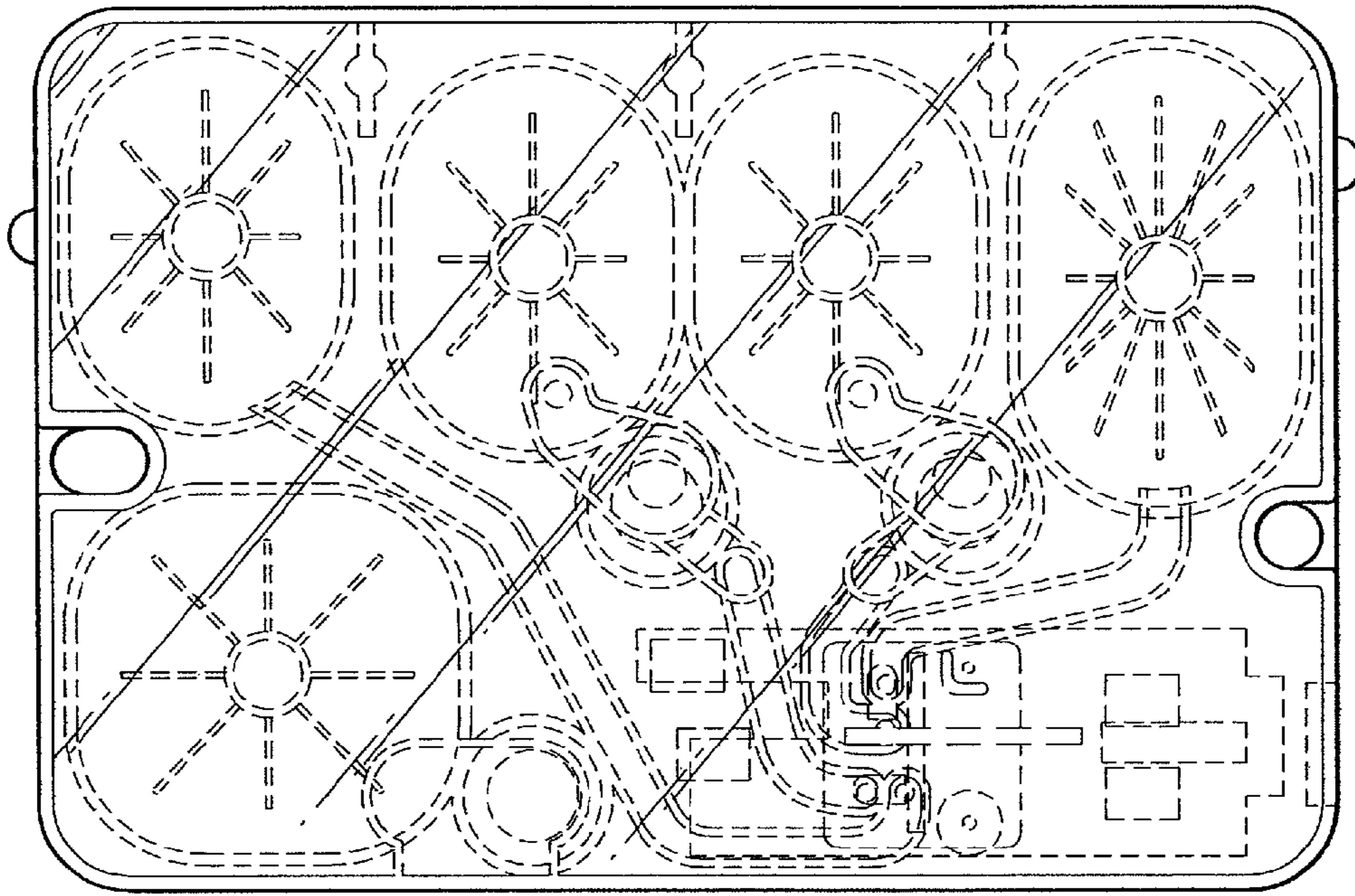

FIG. 3

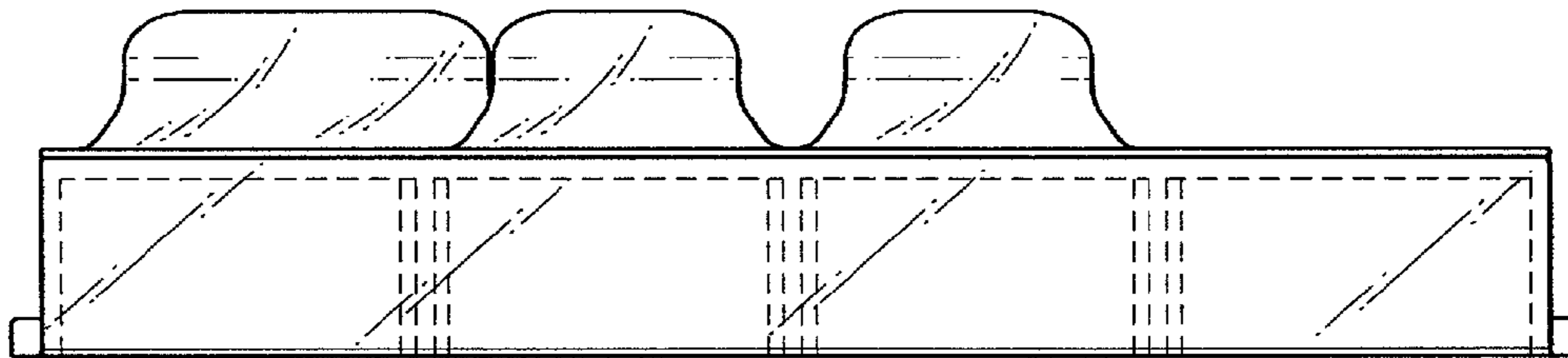

FIG. 4

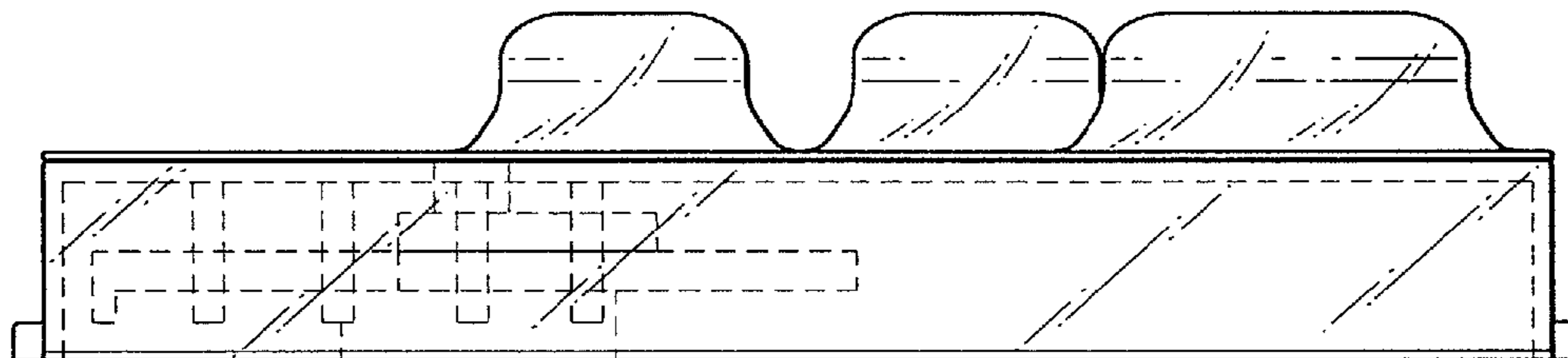

FIG. 5

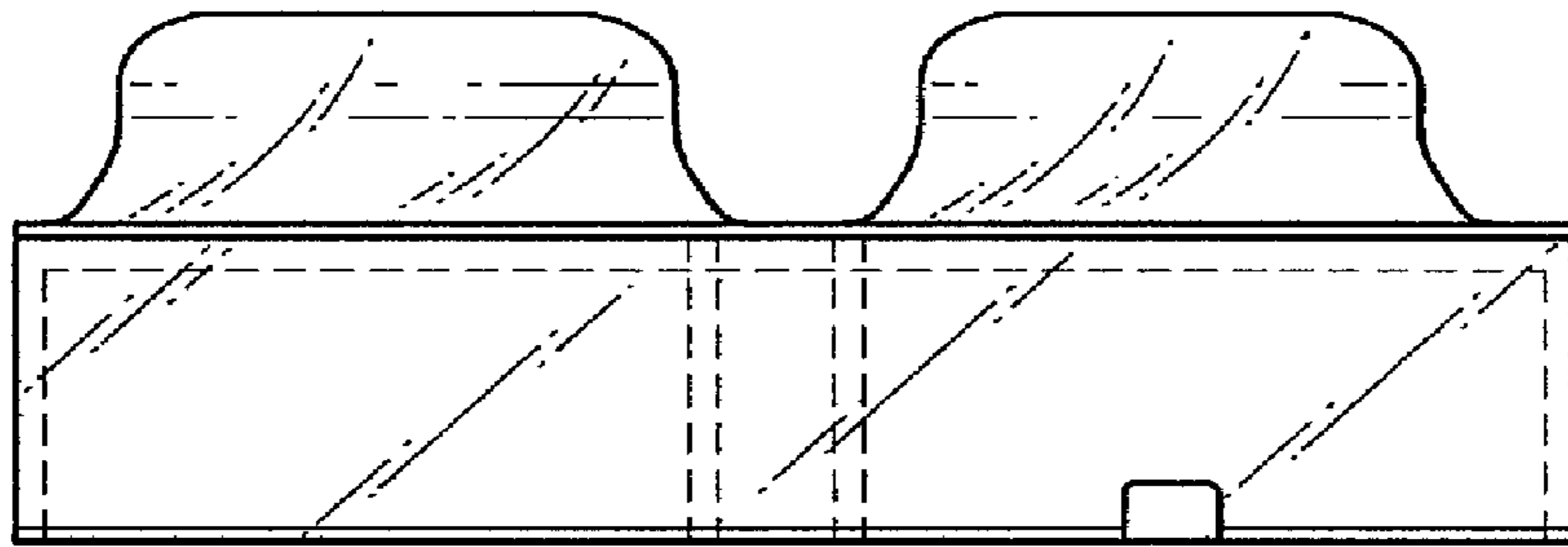

FIG. 6

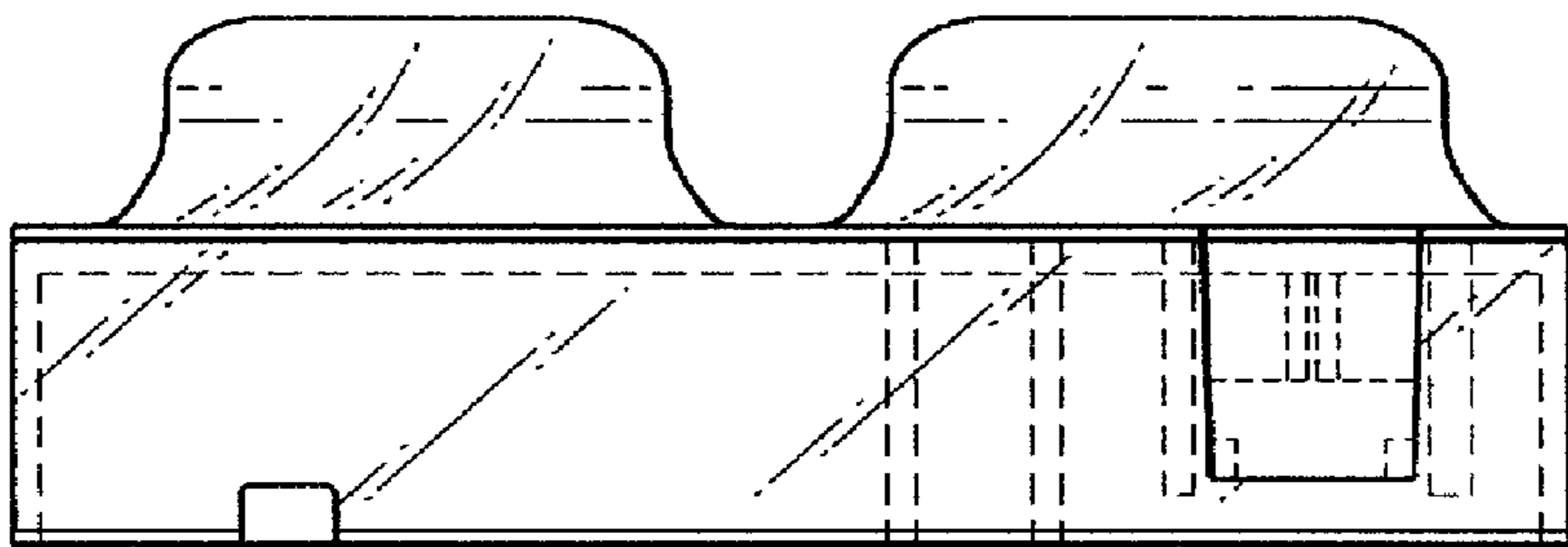

FIG. 7

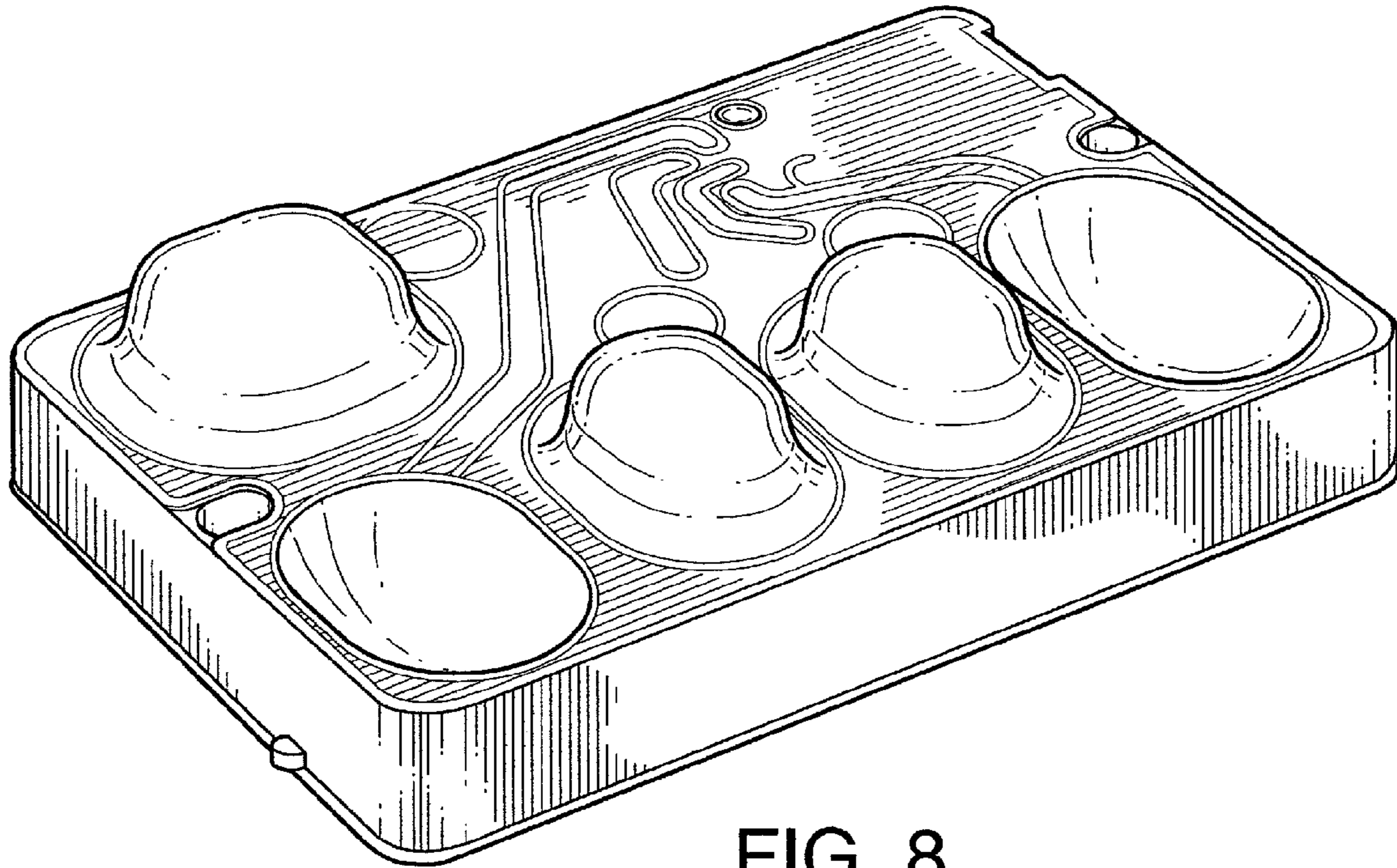

FIG. 8

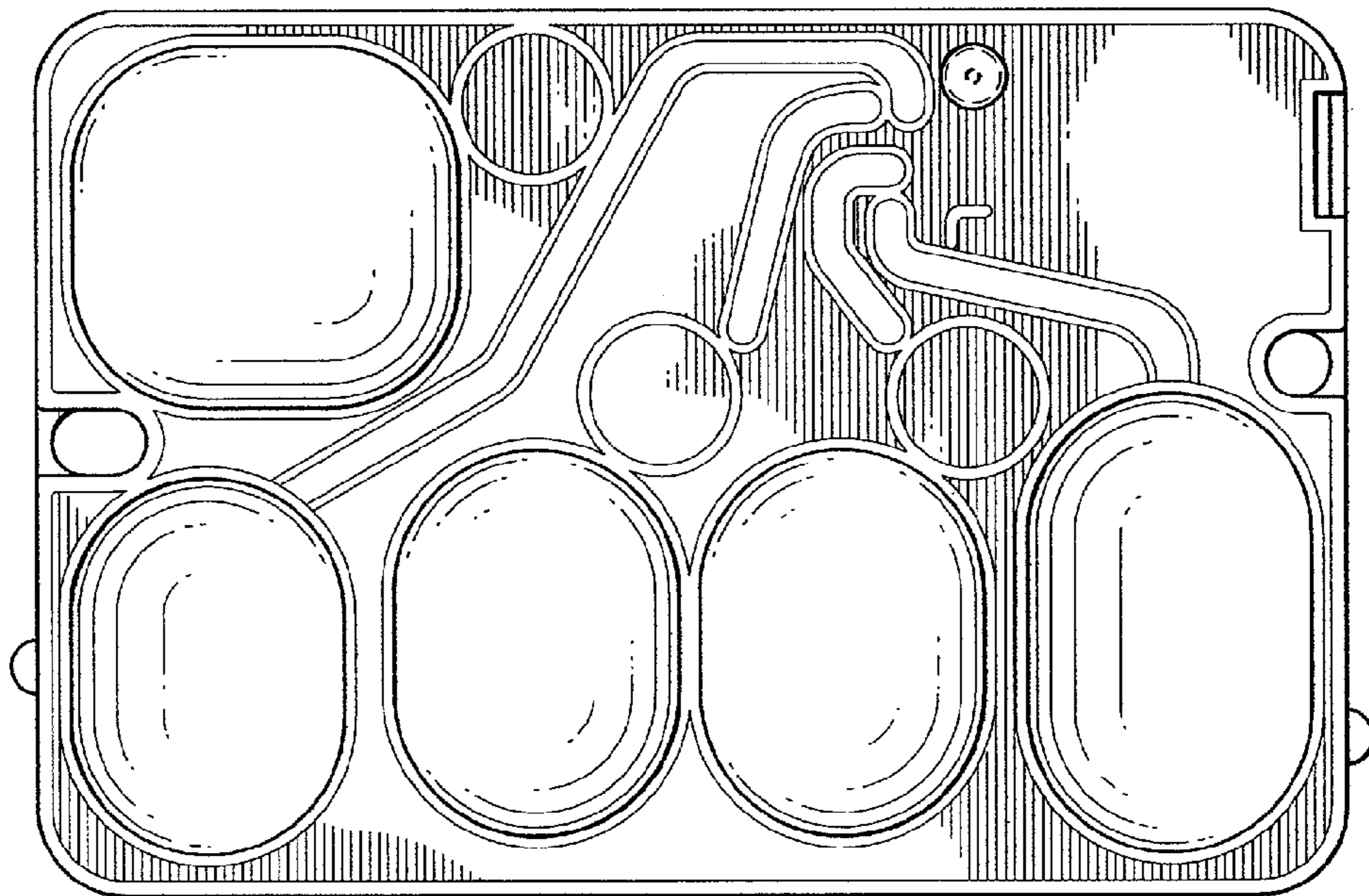

FIG. 9

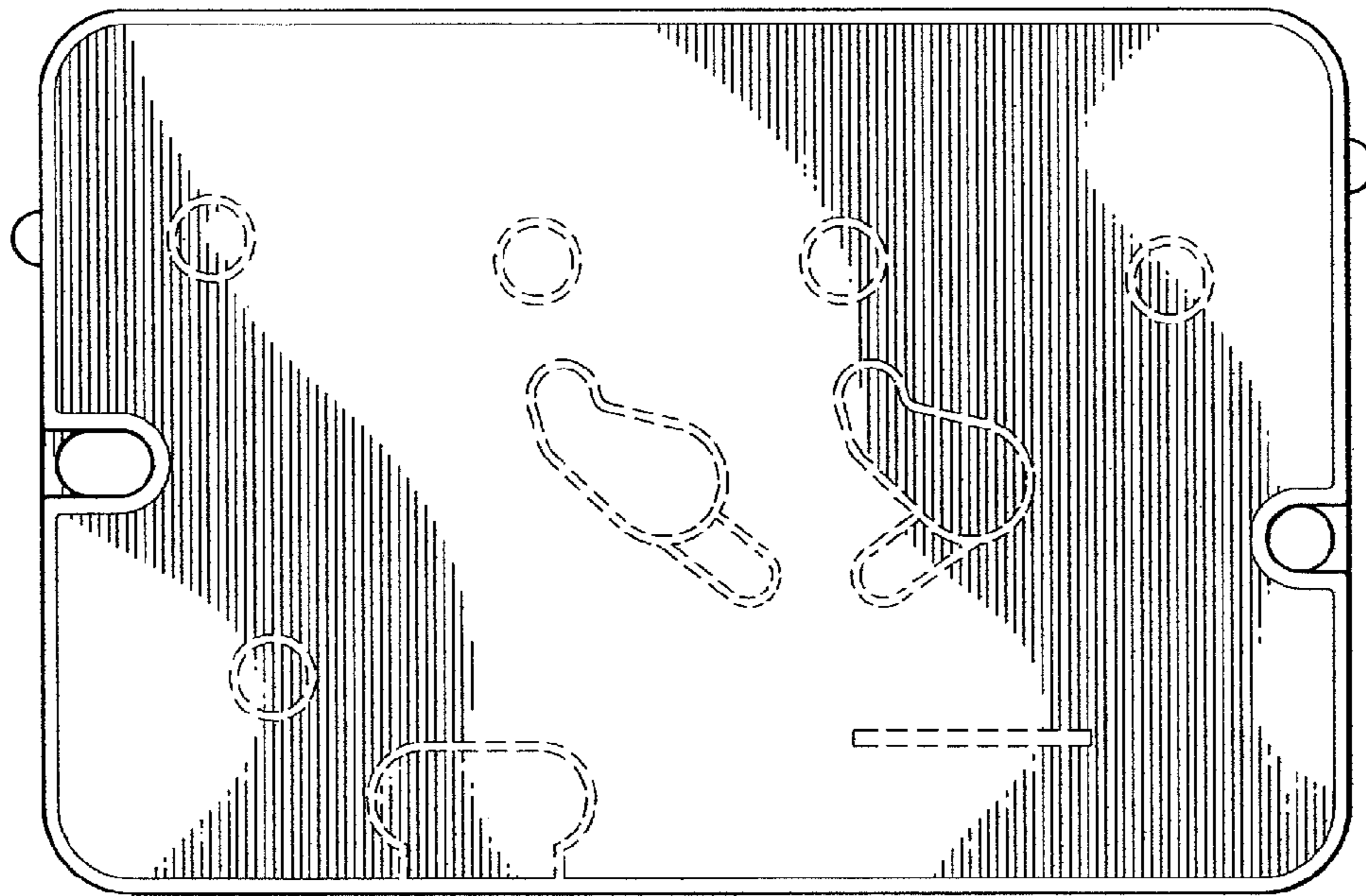

FIG. 10

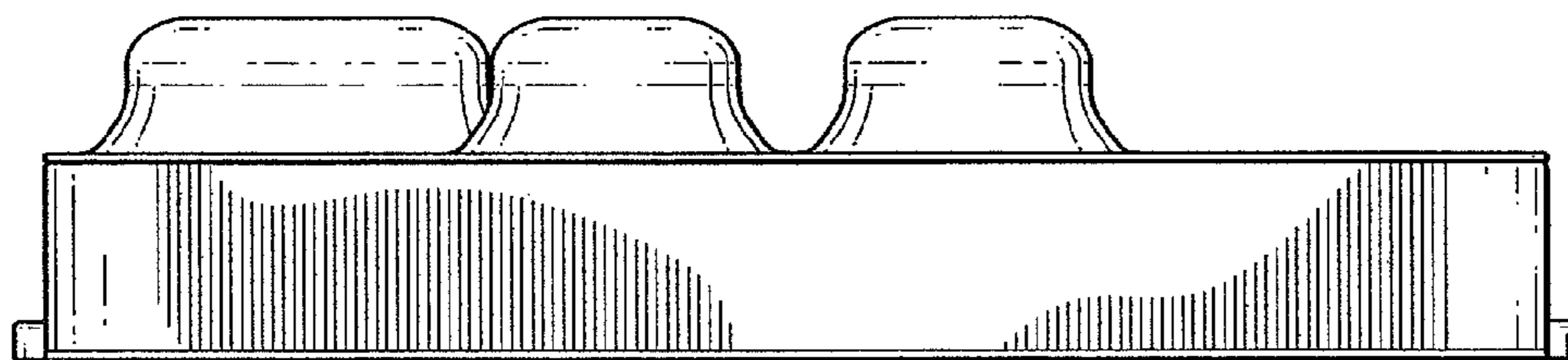

FIG. 11

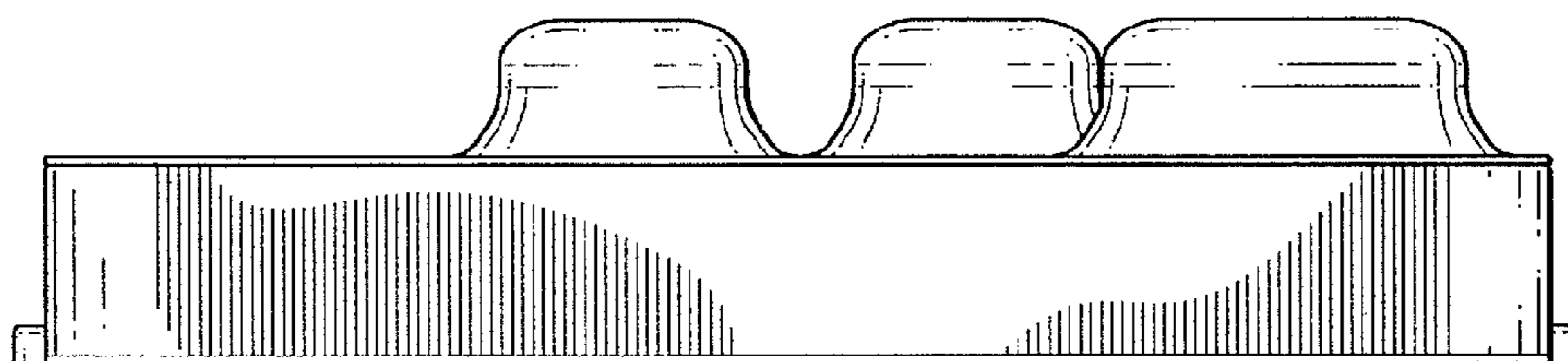

FIG. 12

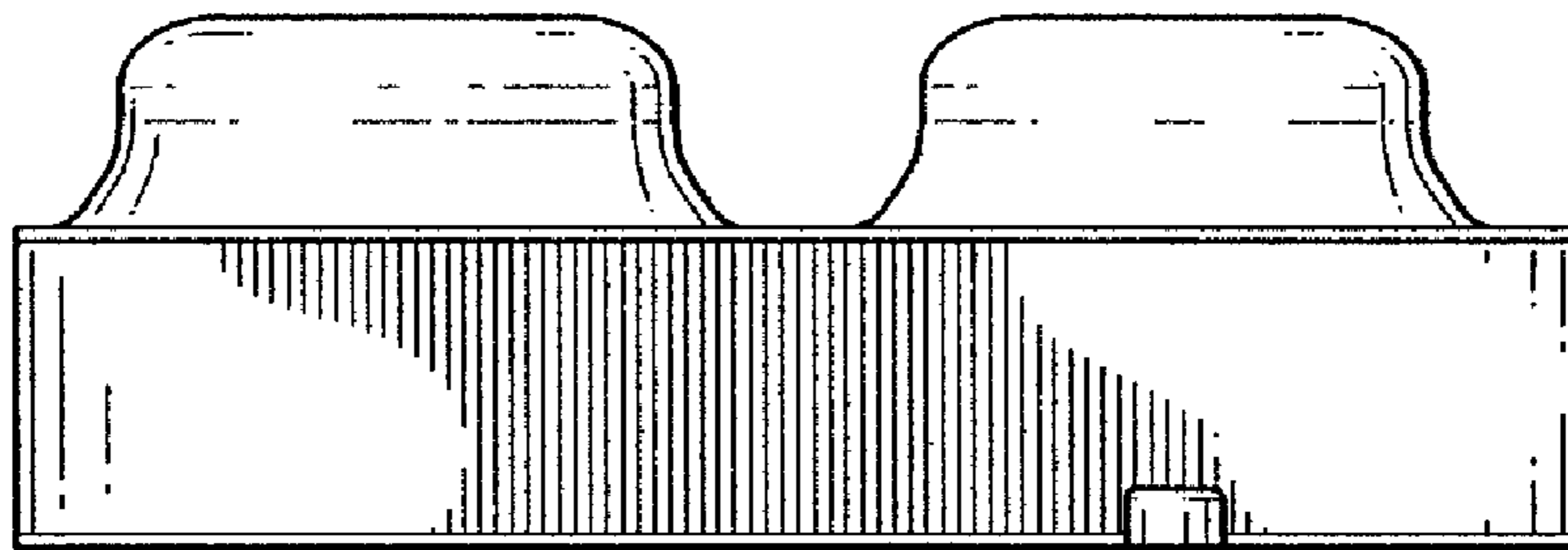

FIG. 13

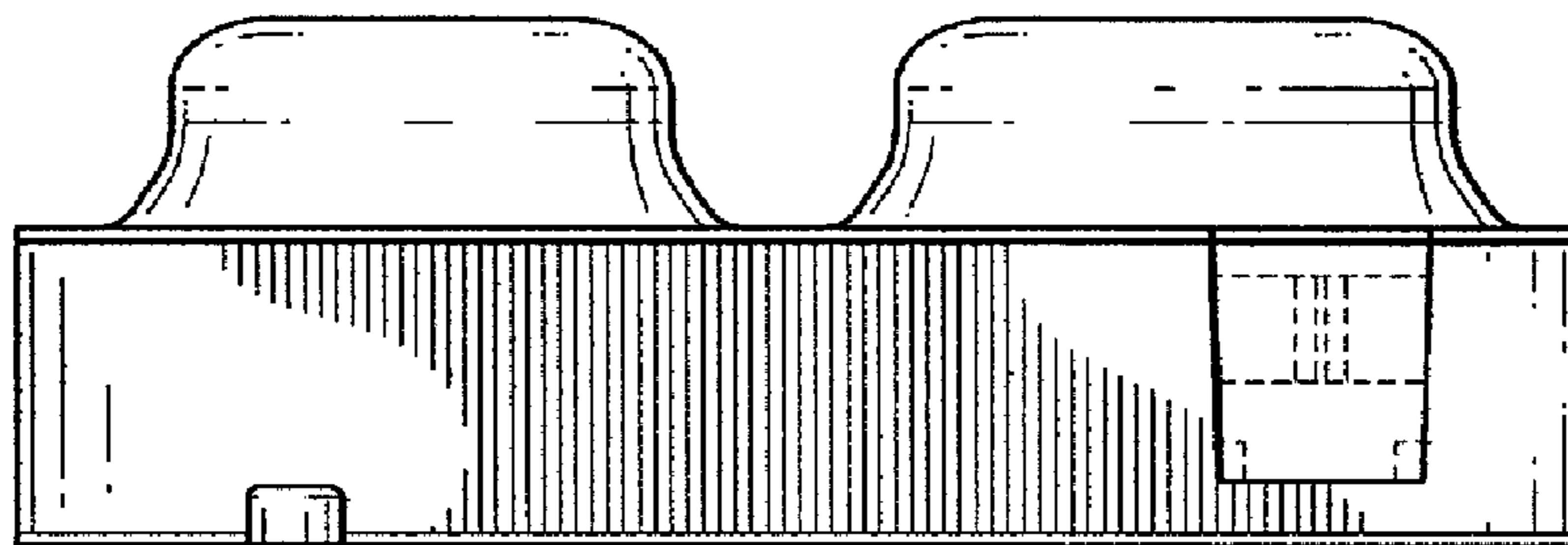

FIG. 14