

US00D639872S

(12) **United States Design Patent**  
**Chiang**

(10) **Patent No.:** **US D639,872 S**  
(45) **Date of Patent:** **\*\* Jun. 14, 2011**

(54) **STEP MACHINE**

(75) Inventor: **Yu-Sung Chiang**, Guangzhou (CN)

(73) Assignee: **Guangzhou Fei Da Exercise & Massager Equipment Co., Ltd.**, Guangzhou (CN)

(\*\*) Term: **14 Years**

(21) Appl. No.: **29/357,067**

(22) Filed: **Mar. 5, 2010**

(30) **Foreign Application Priority Data**

Sep. 24, 2009 (CN) ..... 2009 3 0247651

(51) **LOC (9) Cl.** ..... **21-02**

(52) **U.S. Cl.** ..... **D21/670**

(58) **Field of Classification Search** ..... D21/662,  
D21/663, 668, 670, 671, 686, 688, 689, 694,  
D21/697; 482/51, 52, 53, 79, 80, 146, 147  
See application file for complete search history.

(56) **References Cited**

**U.S. PATENT DOCUMENTS**

5,316,529	A *	5/1994	Wang	482/53
D347,668	S *	6/1994	Wang	D21/670
5,403,254	A *	4/1995	Lundin et al.	482/52
5,454,770	A *	10/1995	Stevens	482/52
D395,933	S *	7/1998	Lin	D21/662
5,810,696	A *	9/1998	Webb	482/52
D408,460	S *	4/1999	Garcia et al.	D21/671
D460,506	S *	7/2002	Tamminga et al.	D21/686
D461,211	S *	8/2002	Kuo	D21/670
6,494,813	B2 *	12/2002	Chen	482/53
D484,930	S *	1/2004	Yang	D21/670

D500,100	S *	12/2004	van der Meer	D21/662
D518,533	S *	4/2006	van der Meer	D21/662
7,041,037	B2 *	5/2006	Huang	482/53
D535,710	S *	1/2007	Hsiung	D21/668
D569,456	S *	5/2008	Nardone et al.	D21/670
D574,900	S *	8/2008	Meile Marcel Tamminga	D21/662
7,510,510	B2 *	3/2009	Chen et al.	482/52
D624,613	S *	9/2010	Hsiung	D21/668
D626,185	S *	10/2010	Wu	D21/662
7,862,491	B1 *	1/2011	Wang	482/147
D633,580	S *	3/2011	Wu	D21/662
7,896,780	B2 *	3/2011	Chen	482/52
2010/0144495	A1 *	6/2010	Chen	482/52
2010/0152006	A1 *	6/2010	Wang	482/147

\* cited by examiner

*Primary Examiner* — Susan E Krakower

(74) *Attorney, Agent, or Firm* — Chun-Ming Shih

(57) **CLAIM**

The ornamental design for a step machine, as shown and described.

**DESCRIPTION**

FIG. 1 is a perspective view of a step machine showing the new design;

FIG. 2 is a front view thereof;

FIG. 3 is a rear view thereof;

FIG. 4 is a left side elevational view thereof;

FIG. 5 is a right side elevational view thereof;

FIG. 6 is a top view thereof; and,

FIG. 7 is a bottom view thereof.

The broken lines in FIG. 7 illustrate portions of the step machine which form no part of the claimed design.

**1 Claim, 7 Drawing Sheets**

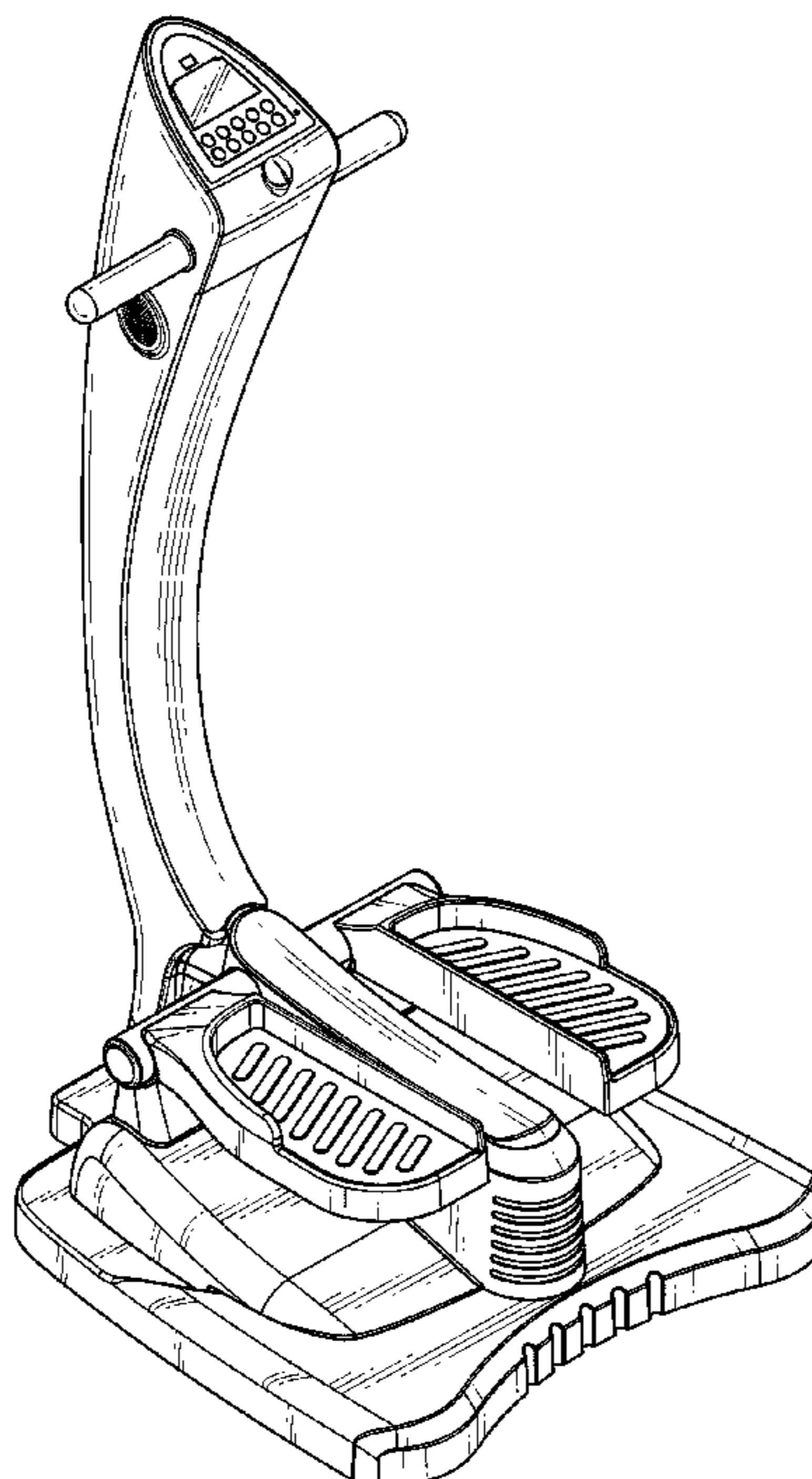

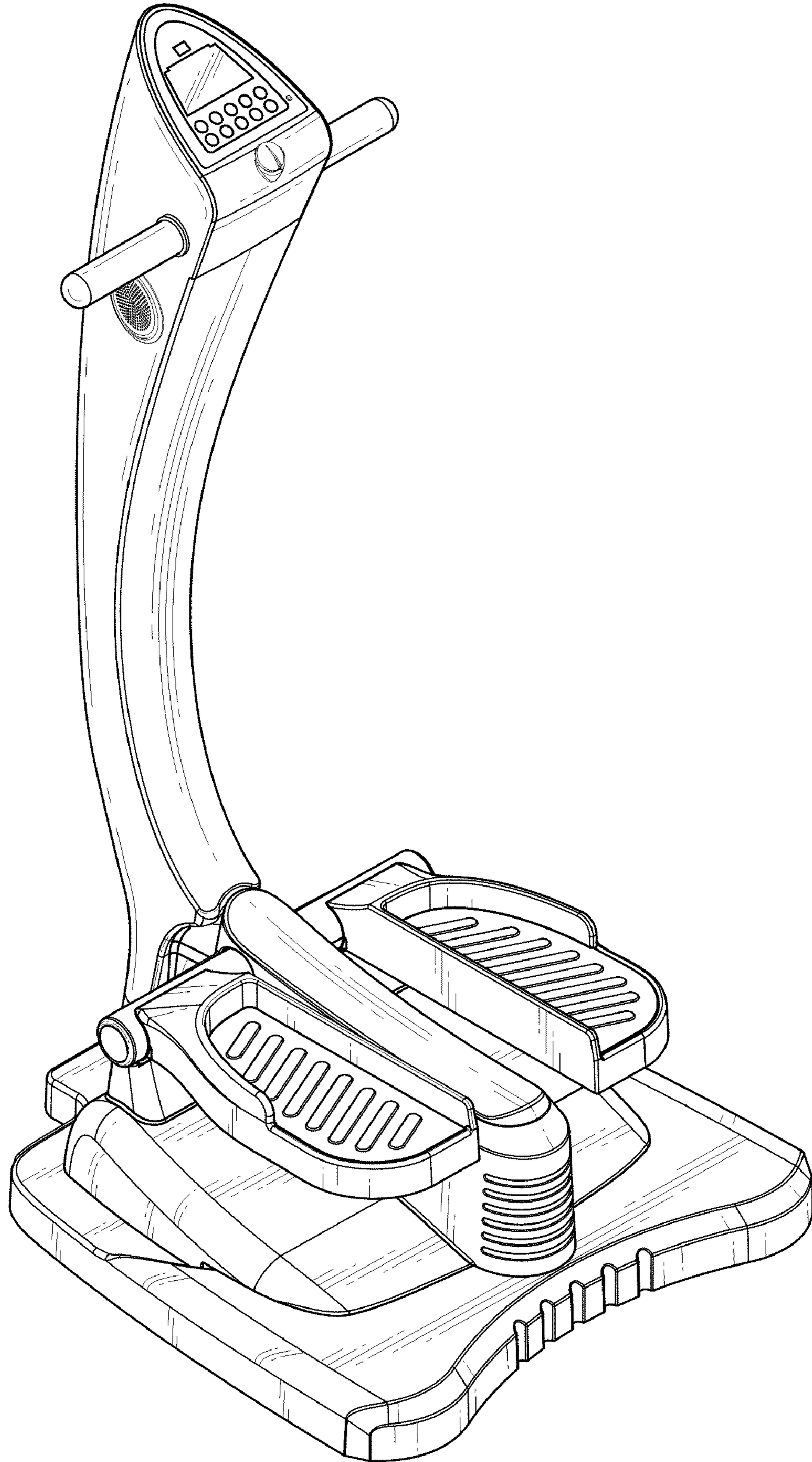

FIG. 1

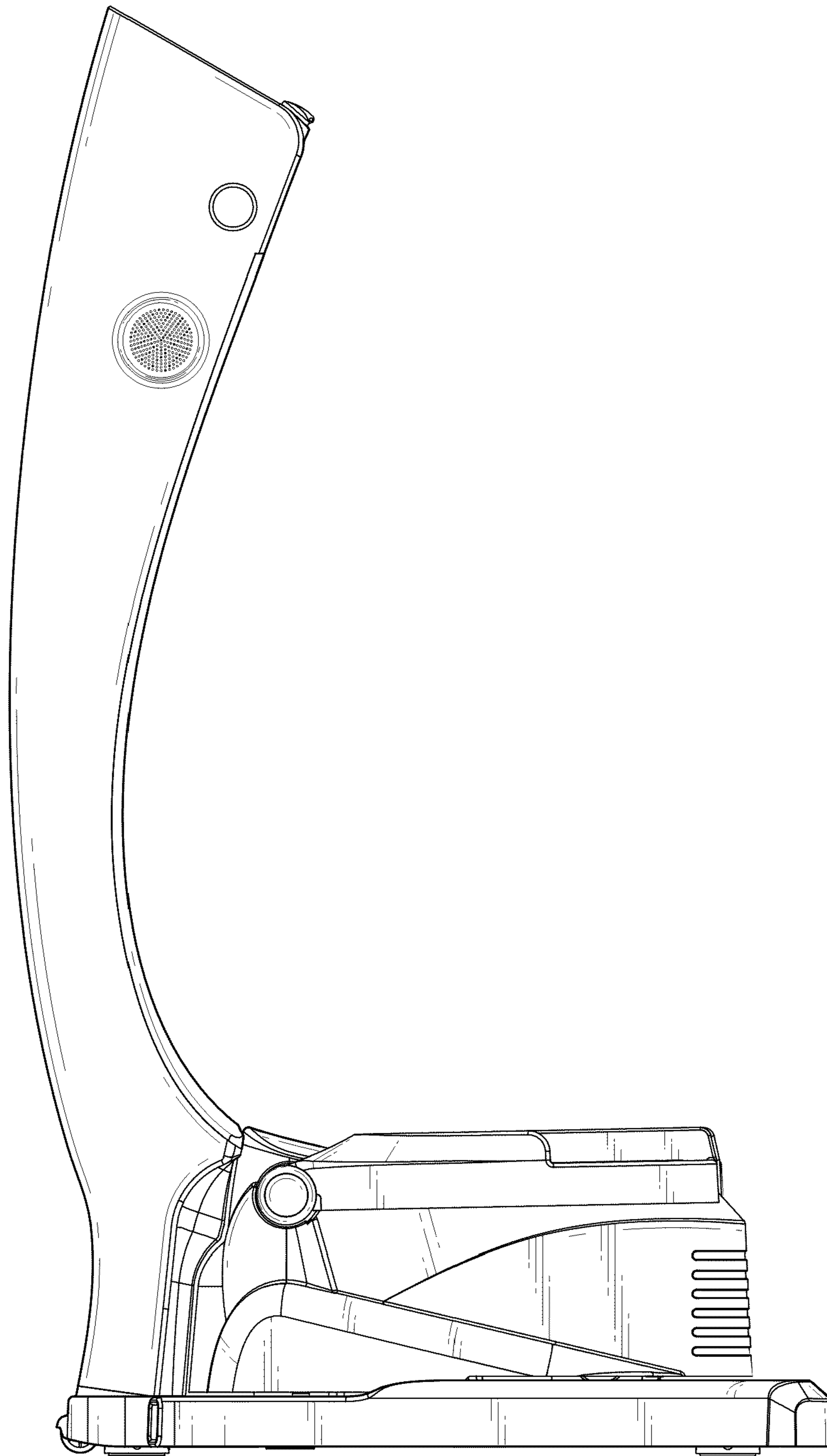

FIG. 2

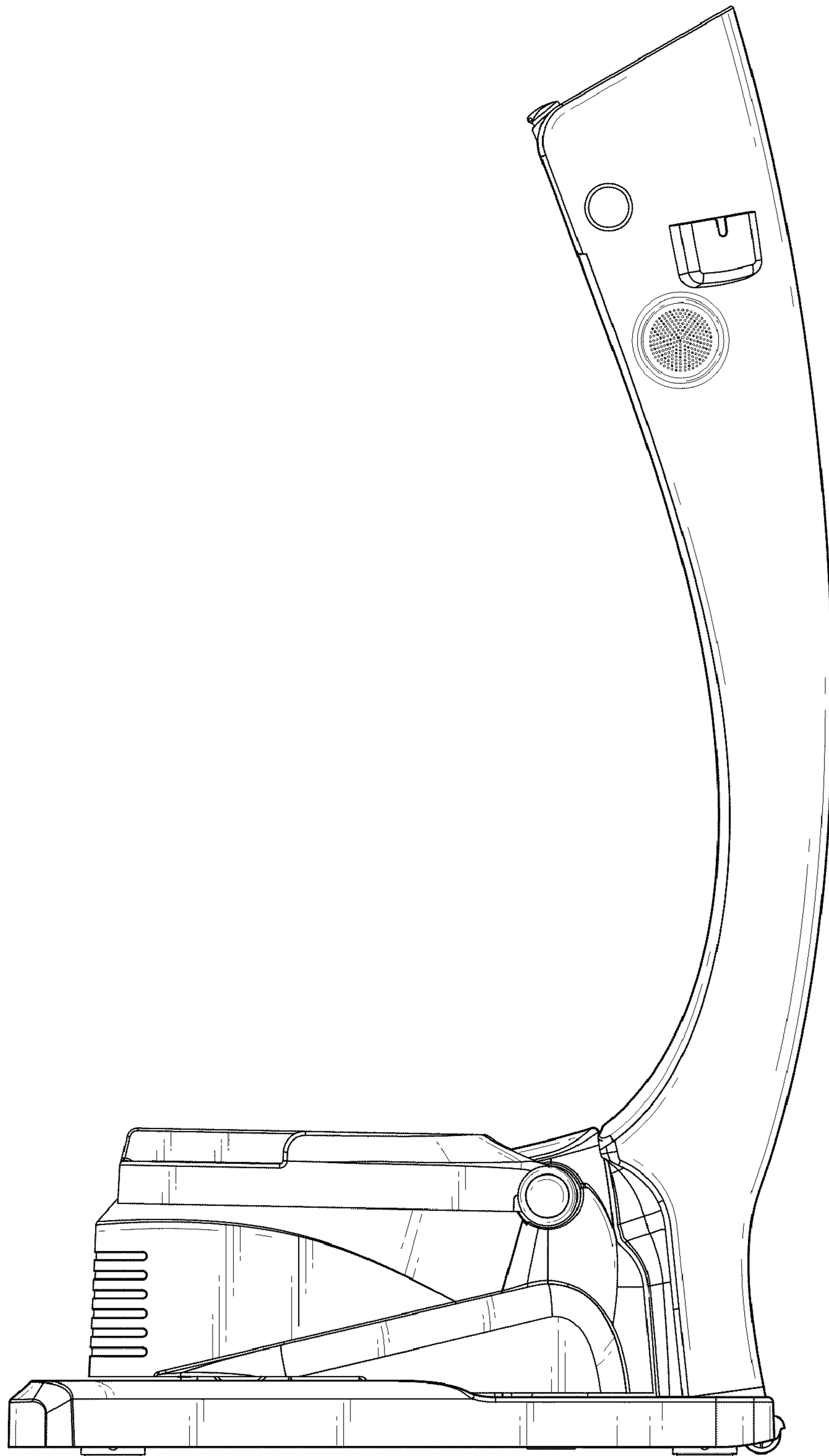

FIG. 3





FIG. 4

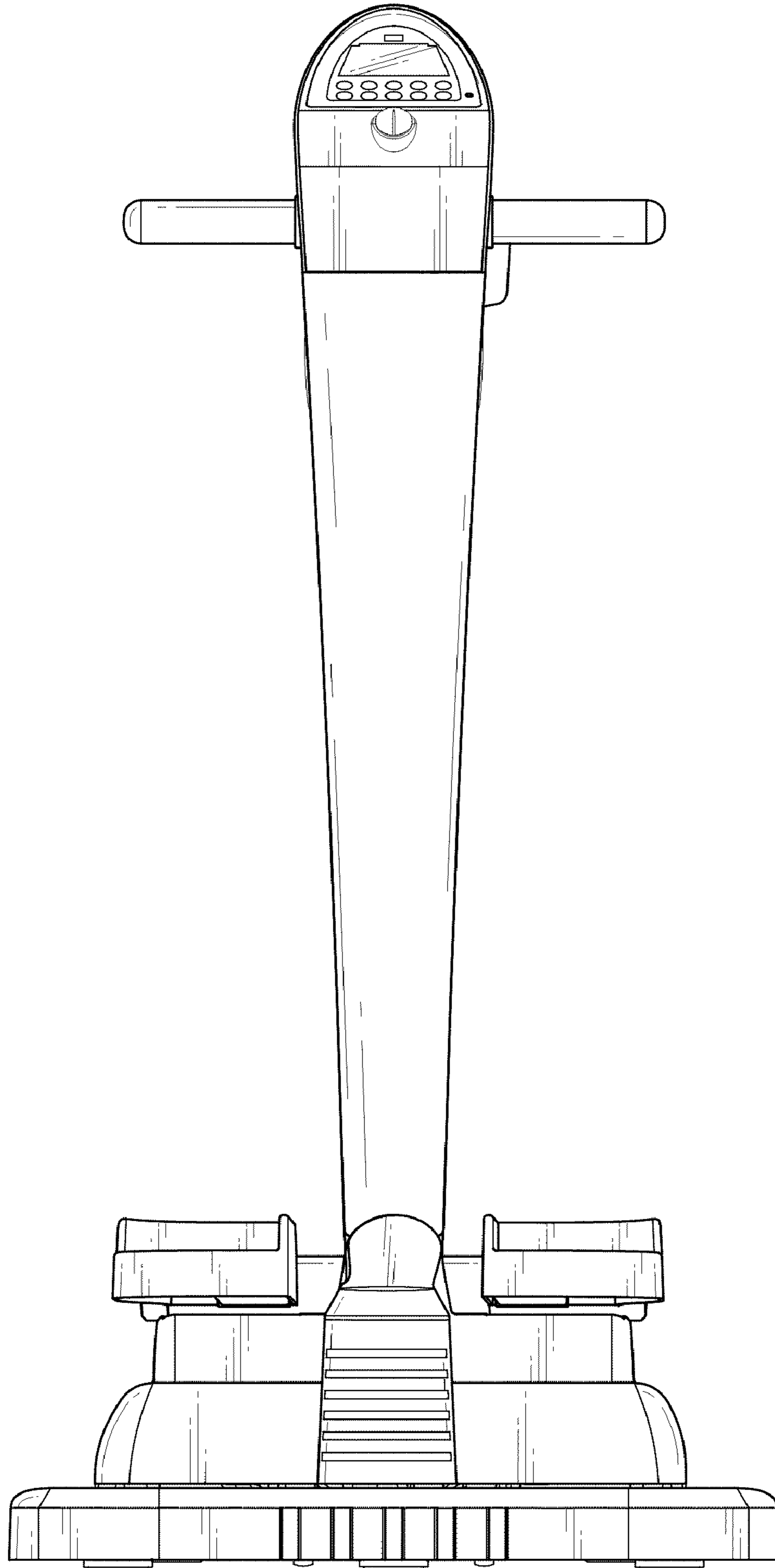

FIG. 5

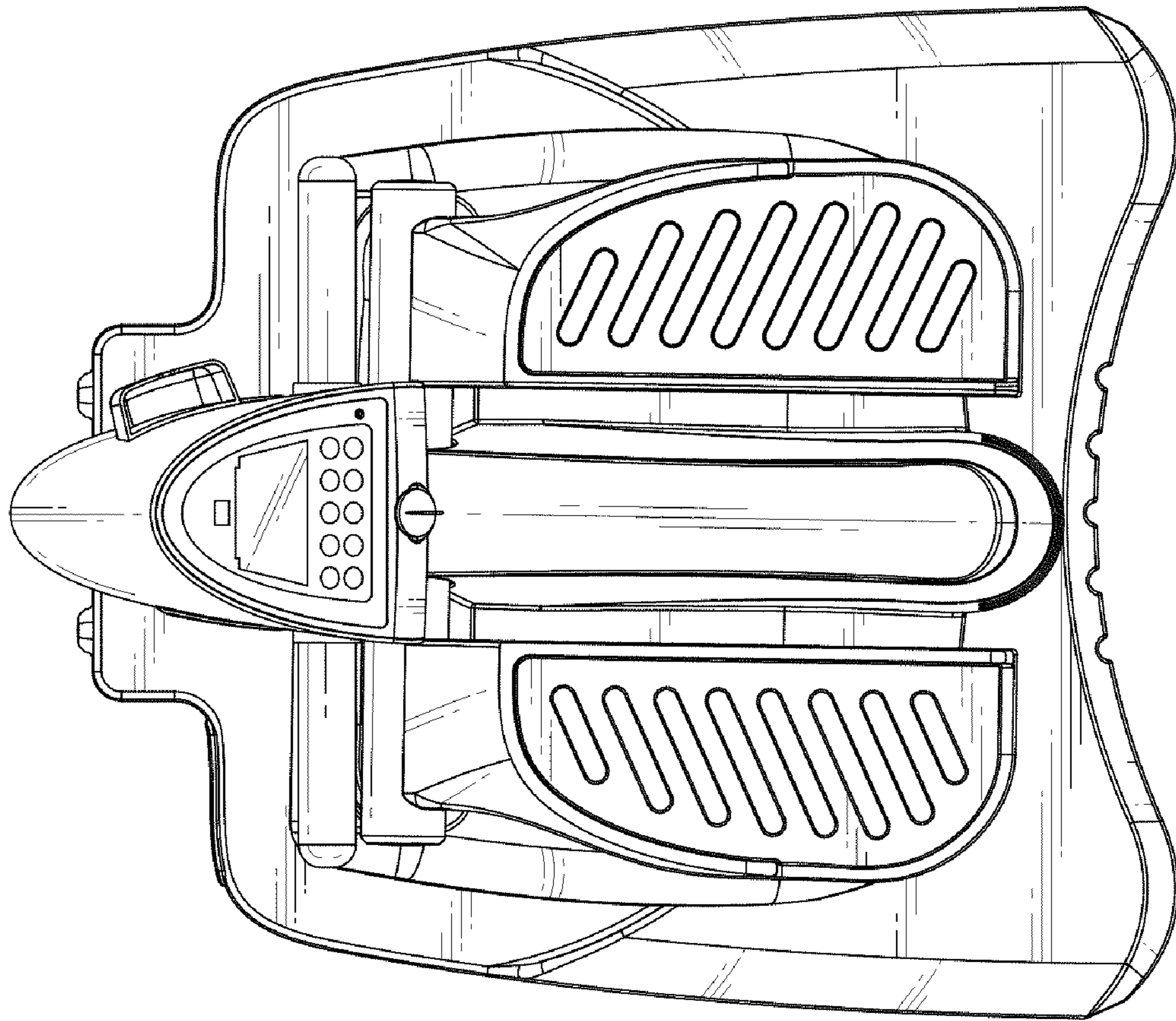

FIG. 6

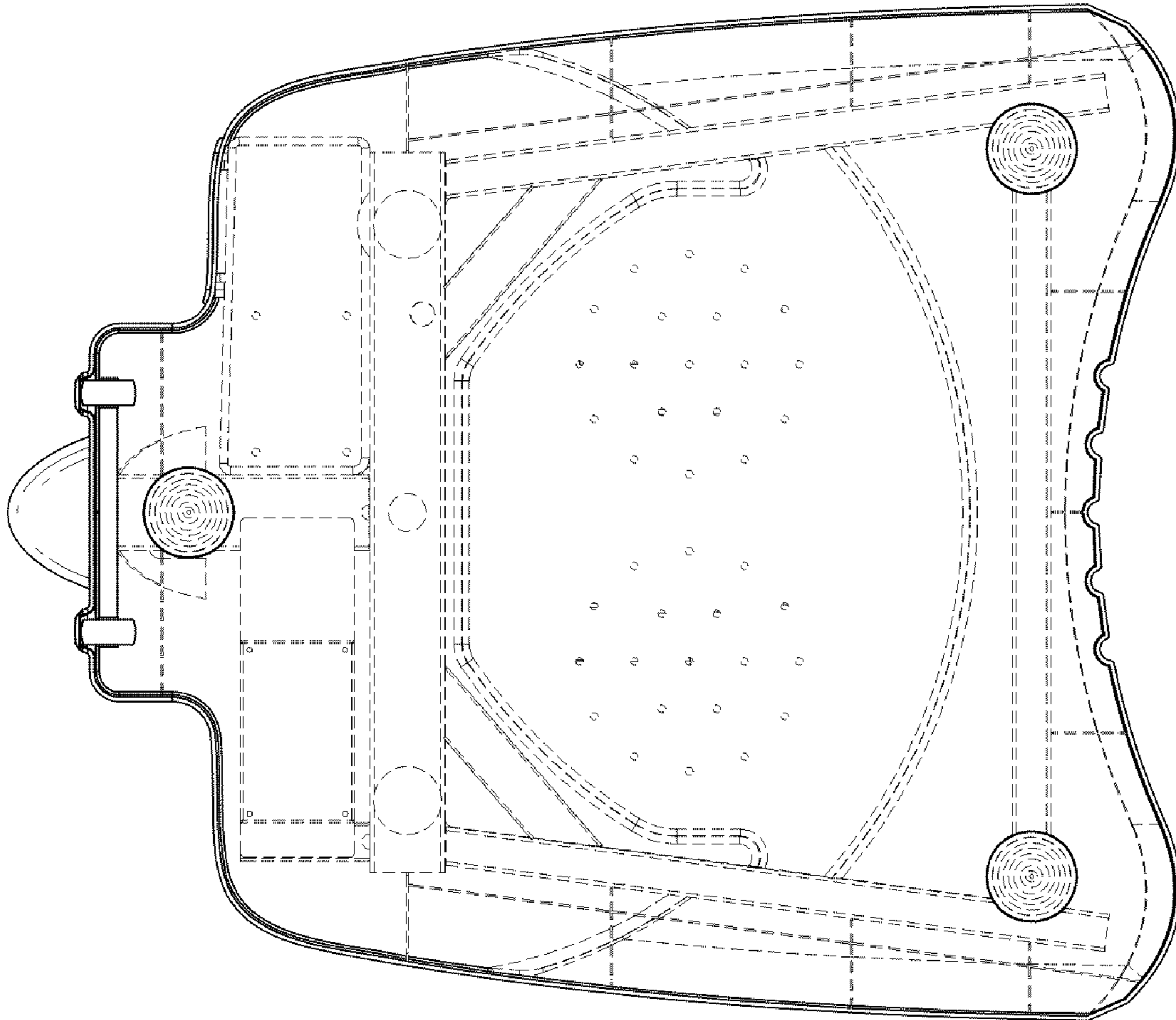

FIG. 7