



US00D639849S

(12) **United States Design Patent**  
**Sato et al.**

(10) **Patent No.:** **US D639,849 S**

(45) **Date of Patent:** **\*\* Jun. 14, 2011**

(54) **PRINTER**

(75) Inventors: **Yukihiko Sato**, Nagoya (JP); **Nobuyuki Iwai**, Chita-gun (JP); **Tomoyuki Nanno**, Nagoya (JP)

(73) Assignee: **Brother Industries, Ltd.**, Nagoya (JP)

(\*\*) Term: **14 Years**

(21) Appl. No.: **29/353,721**

(22) Filed: **Jan. 13, 2010**

(30) **Foreign Application Priority Data**

Jul. 23, 2009 (JP) ..... 2009-016742

(51) **LOC (9) Cl.** ..... **14-02**

(52) **U.S. Cl.** ..... **D18/50**

(58) **Field of Classification Search** ..... D18/14,  
D18/19, 36-37, 50, 54, 54.1, 55; D14/420-425,  
D14/463-470; 400/613, 613.1-613.4, 690.1-690.4,  
400/691-694

See application file for complete search history.

(56) **References Cited**

**U.S. PATENT DOCUMENTS**

D528,154 S 9/2006 Hattori  
D528,596 S 9/2006 Hattori

D550,768 S 9/2007 Hoshiya et al.  
D556,256 S 11/2007 Matsumoto  
D556,257 S 11/2007 Yamaguchi  
D596,226 S 7/2009 Yamaguchi  
D606,115 S 12/2009 Sato  
D609,270 S \* 2/2010 Kato et al. .... D18/55  
D611,091 S \* 3/2010 Ishikawa et al. .... D18/55

**OTHER PUBLICATIONS**

U.S. Appl. No. 29/300,518, filed Apr. 4, 2008.

\* cited by examiner

*Primary Examiner* — Cathy Anne MacCormac

(74) *Attorney, Agent, or Firm* — Oliff & Berridge, PLC

(57) **CLAIM**

The ornamental design for a printer, as shown and described.

**DESCRIPTION**

FIG. 1 is a perspective view of a printer;

FIG. 2 is a front view thereof;

FIG. 3 is a top view thereof;

FIG. 4 is a left-side view thereof;

FIG. 5 is a right-side view thereof;

FIG. 6 is a rear view thereof; and,

FIG. 7 is a bottom view thereof.

The broken lines depict environmental subject matter only and form no part of the claimed design.

**1 Claim, 7 Drawing Sheets**

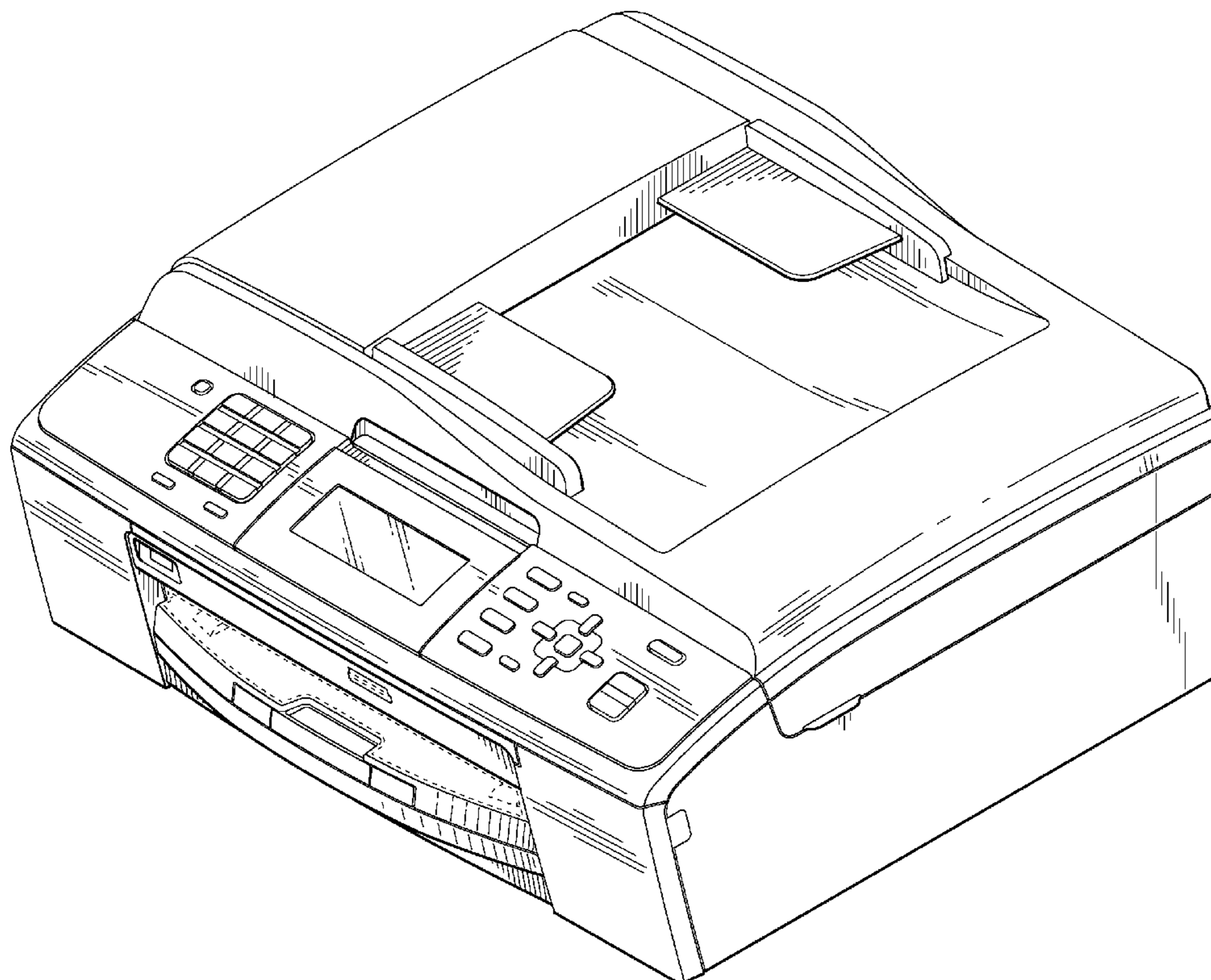

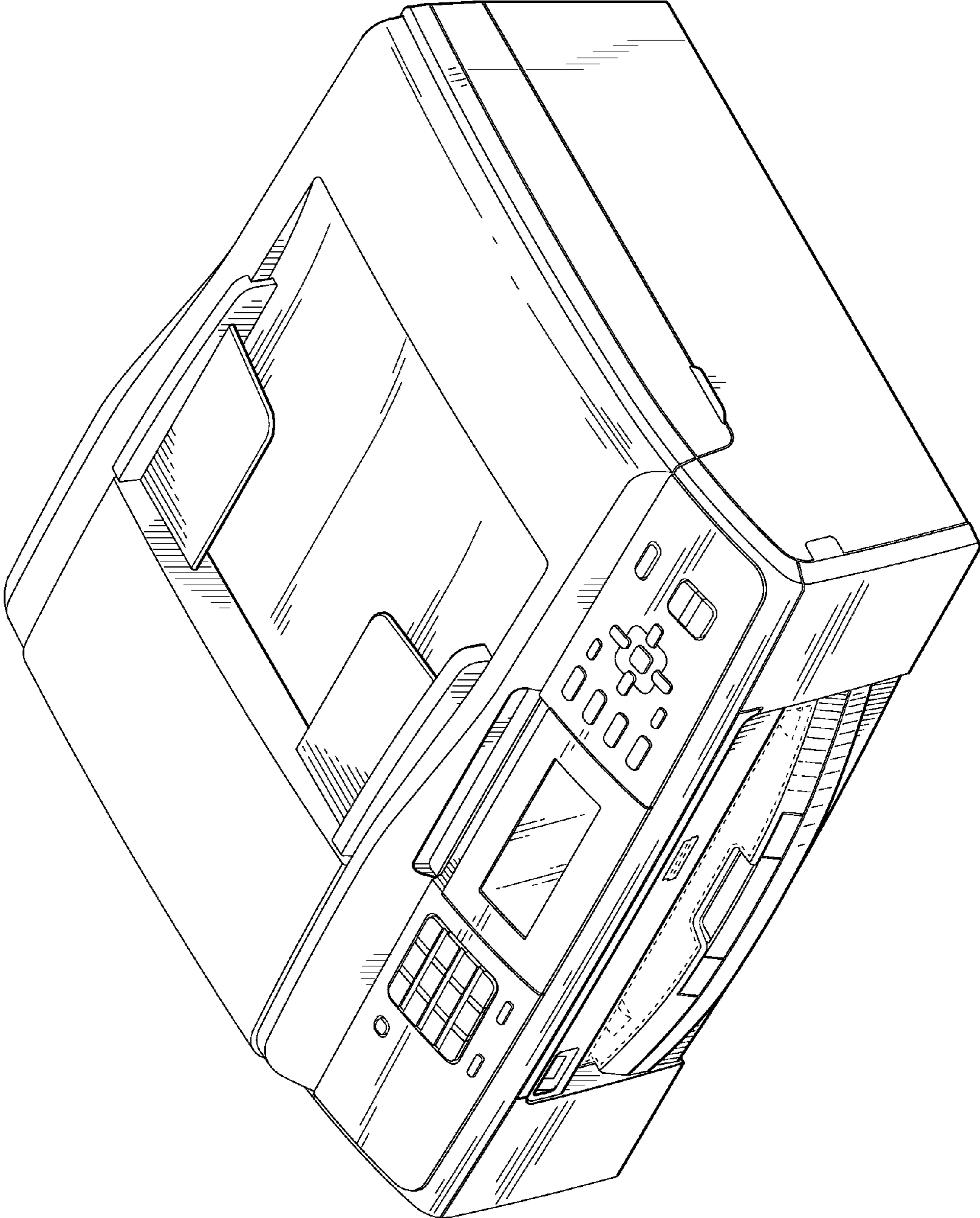

FIG. 1

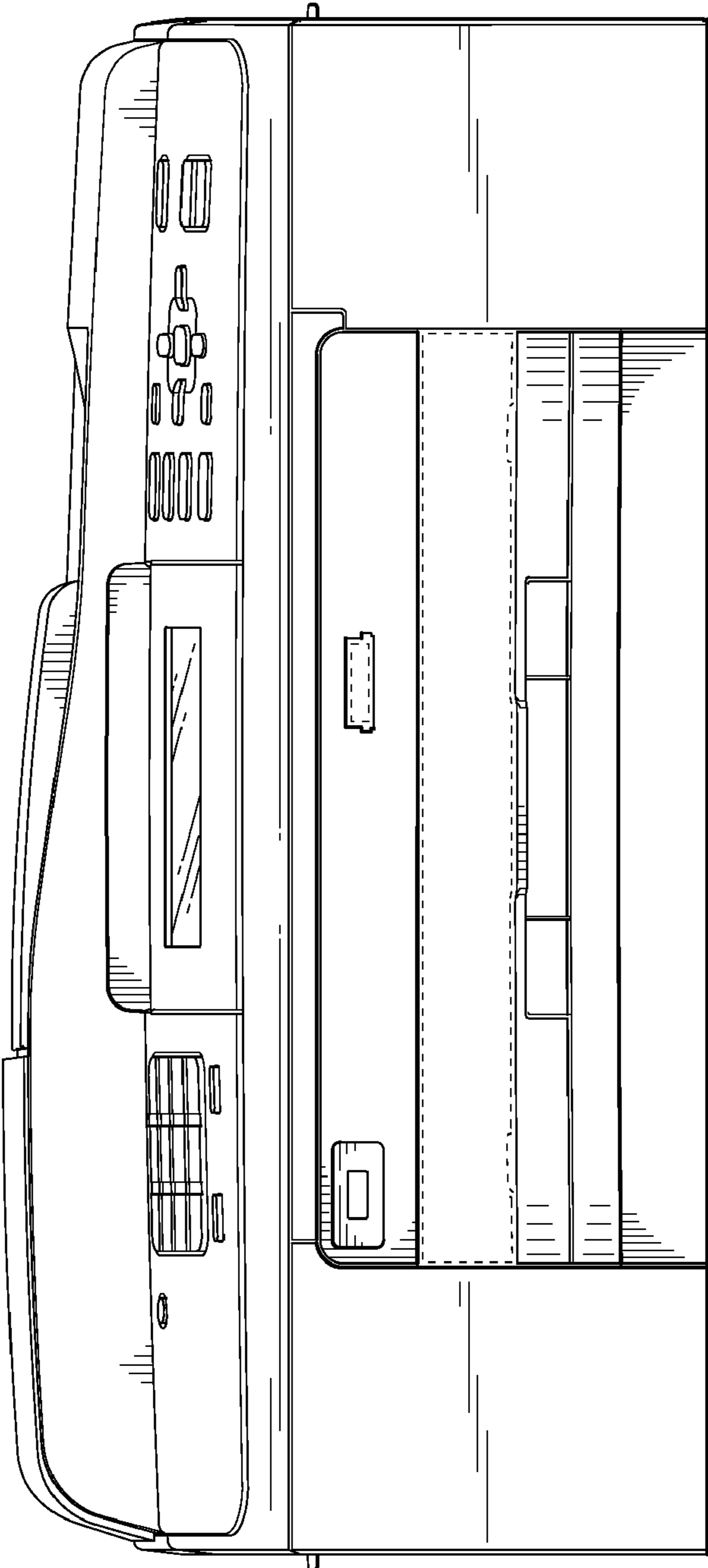

FIG. 2

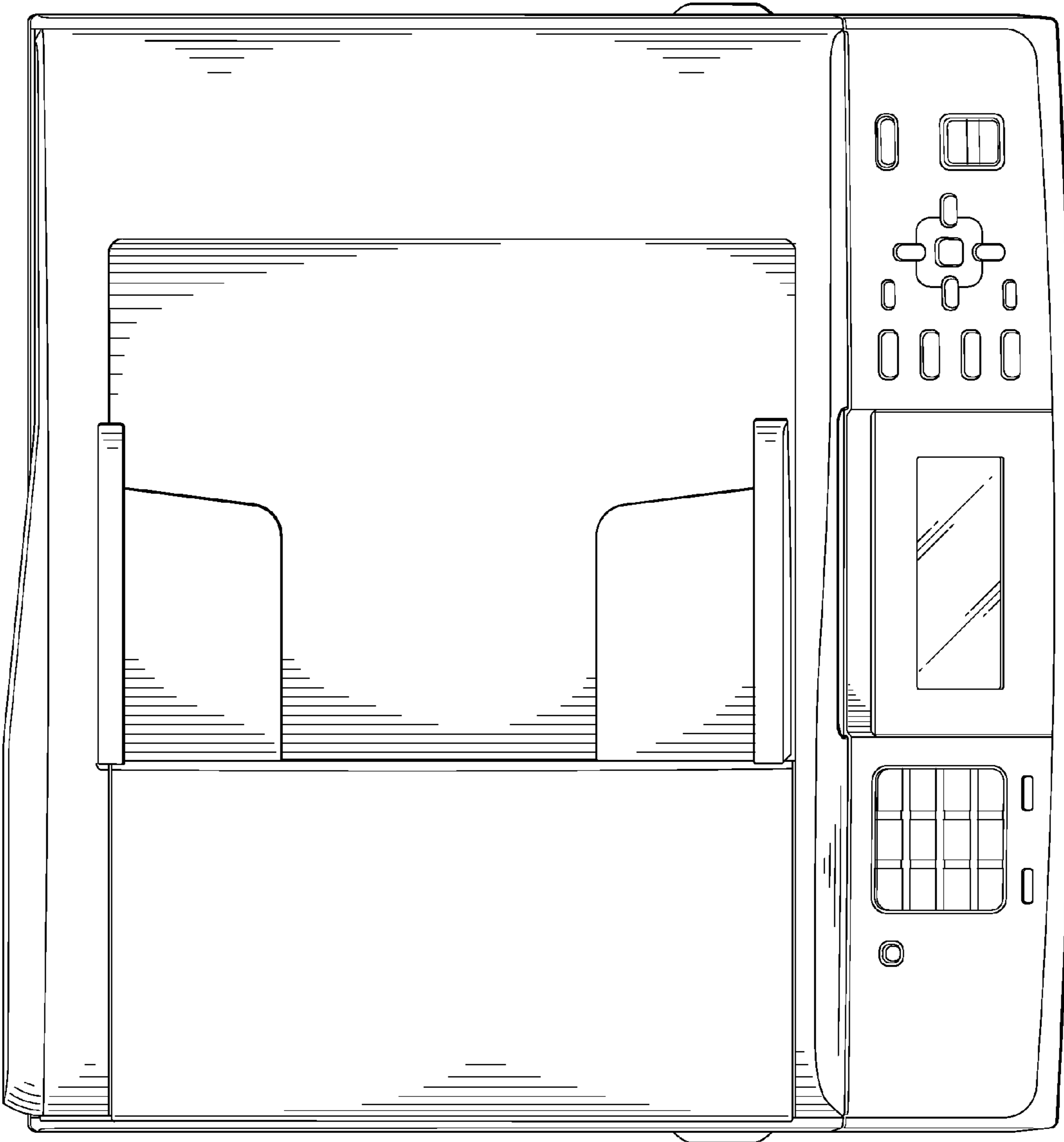

FIG. 3

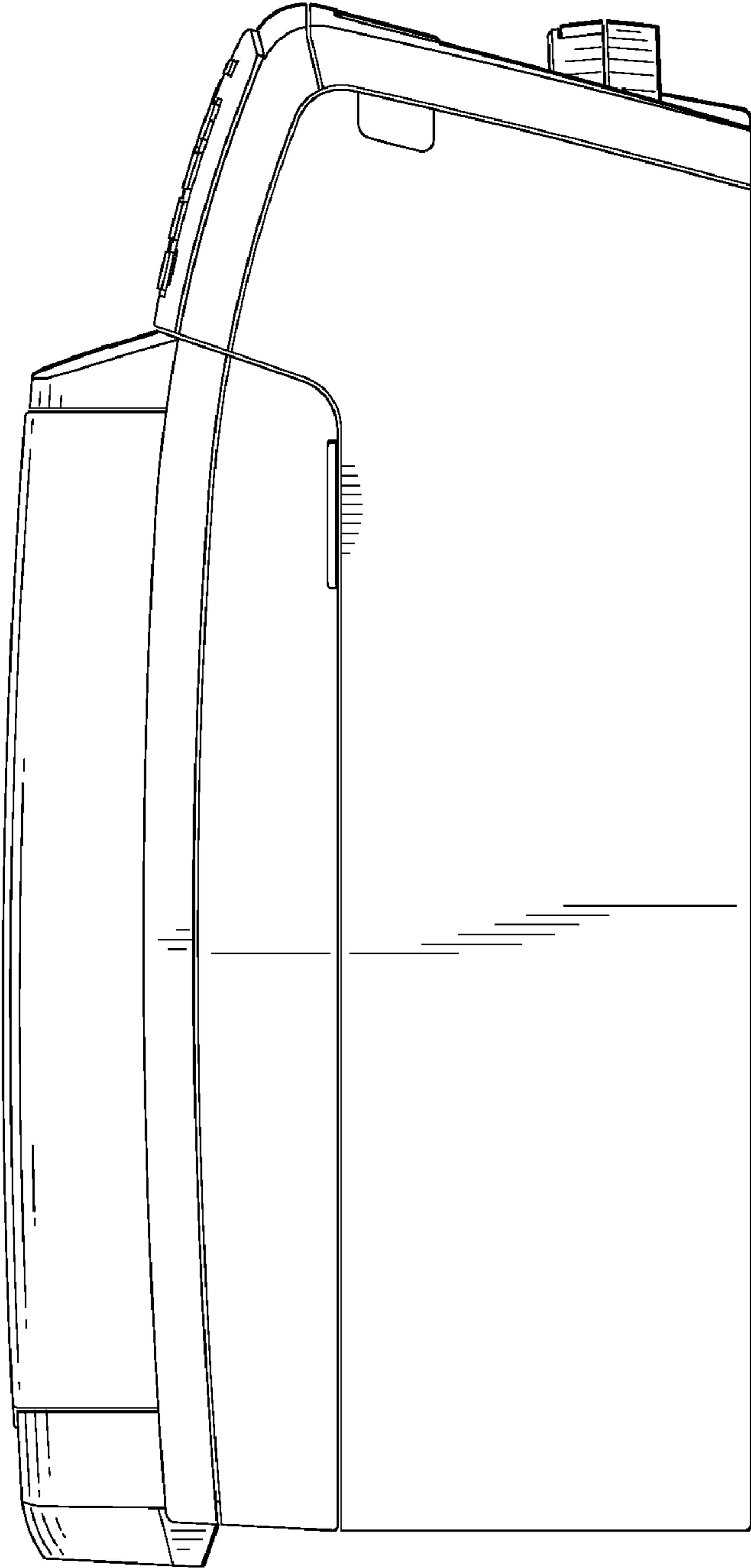

FIG. 4

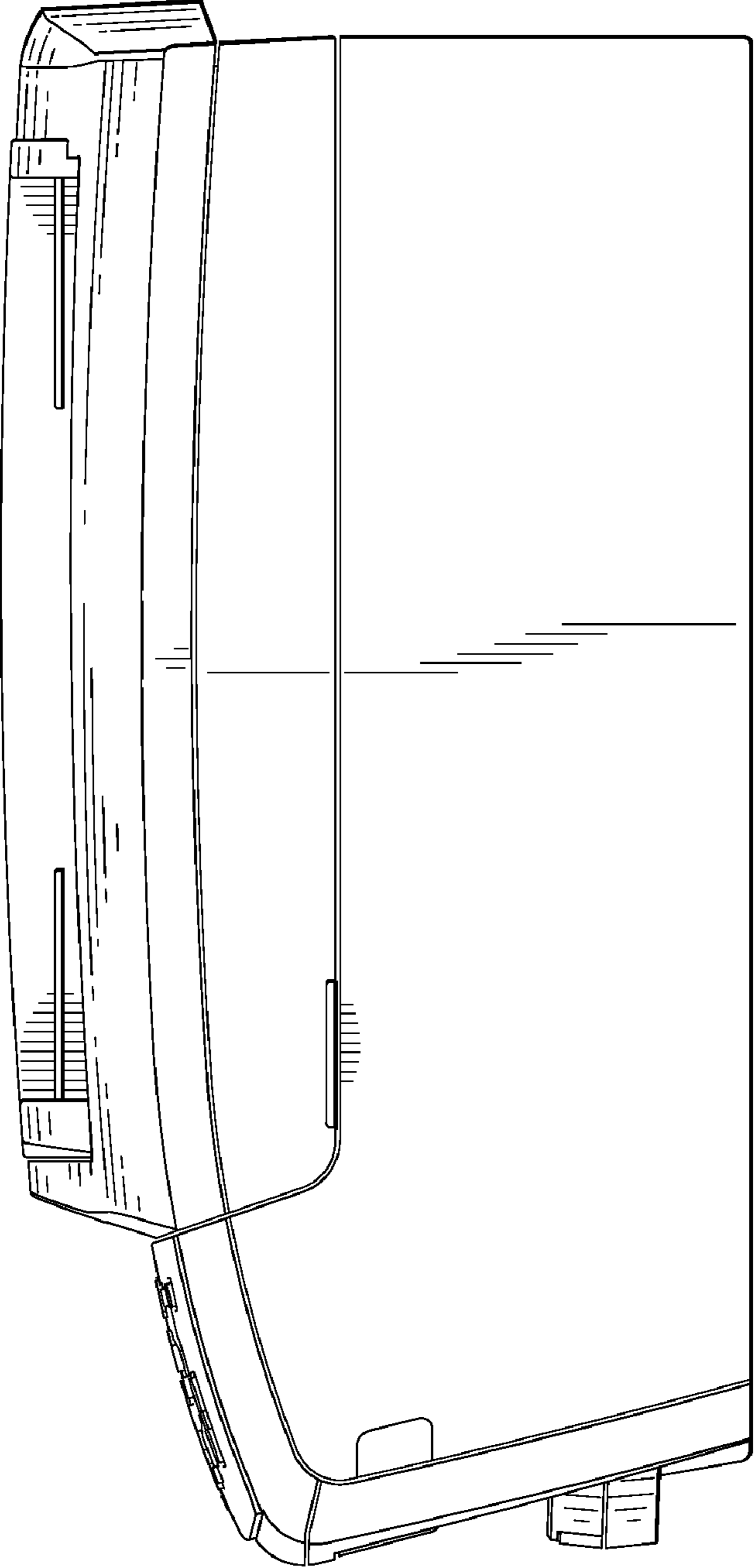

FIG. 5

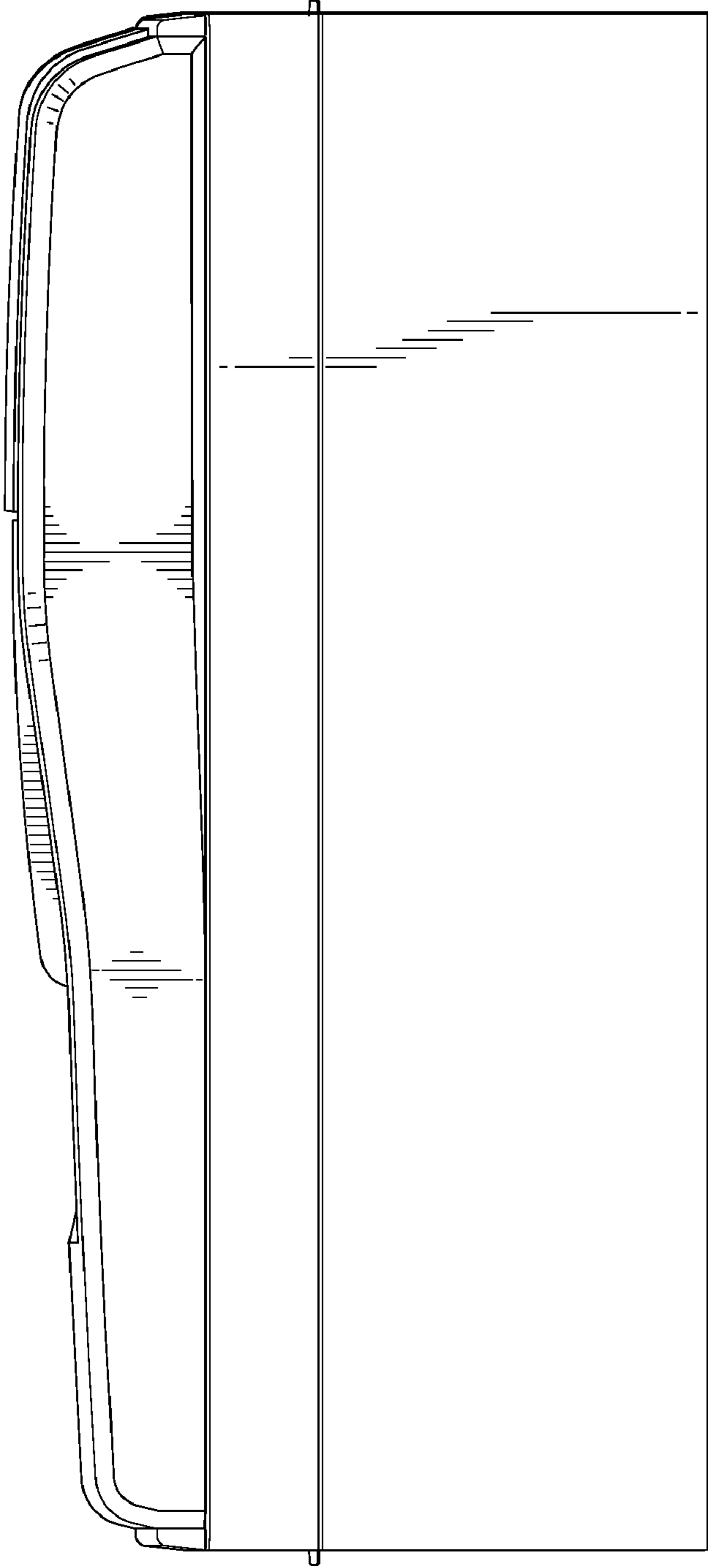

FIG. 6

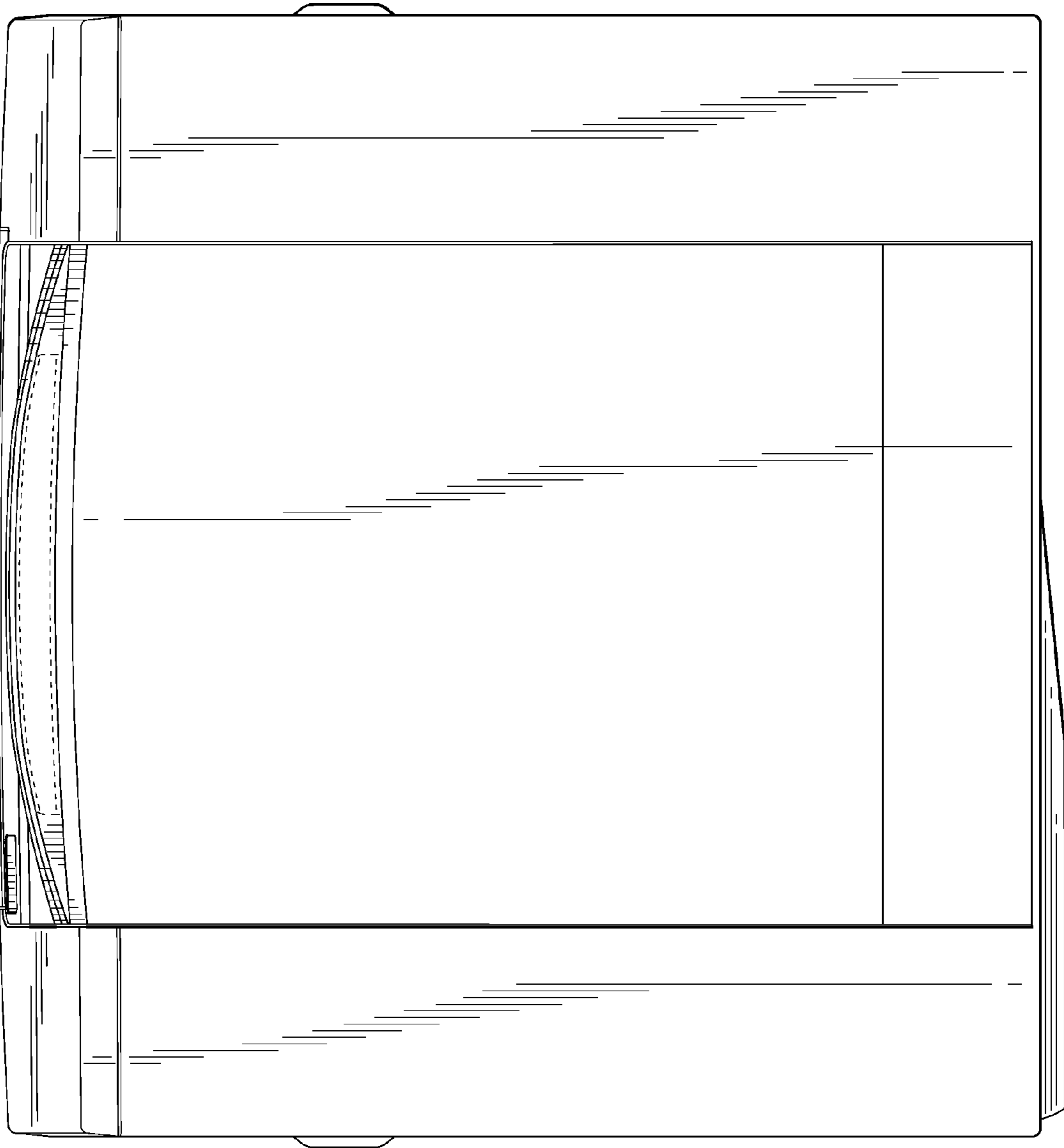

FIG. 7