



US00D639794S

(12) **United States Design Patent**  
**Fiore, IV et al.**

(10) **Patent No.:** **US D639,794 S**  
(45) **Date of Patent:** **\*\* Jun. 14, 2011**

- (54) **ISO/DIN HEAD UNIT PROVISION WITH POCKET**
- (75) Inventors: **Anthony Fiore, IV**, Palm Coast, FL (US); **Edward Robertson**, Port Orange, FL (US)
- (73) Assignee: **Metra Electronics Corporation**, Holly Hill, FL (US)
- (\*\*) Term: **14 Years**

- D496,354 S 9/2004 Quilling, II
- D501,852 S 2/2005 Quilling, II
- D503,400 S 3/2005 Quilling, II
- D503,401 S 3/2005 Quilling, II
- D504,423 S 4/2005 Quilling, II
- D505,672 S 5/2005 Quilling
- D507,791 S 7/2005 Quilling, II
- D508,486 S 8/2005 Quilling, II
- D513,508 S 1/2006 Quilling, II
- D517,061 S 3/2006 Quilling, II
- D519,995 S 5/2006 Quilling, II
- D531,879 S 11/2006 Quilling, II
- 7,177,730 B2 2/2007 Daly et al.

(Continued)

(21) Appl. No.: **29/365,088**

(22) Filed: **Jul. 2, 2010**

- (51) **LOC (9) Cl.** ..... **14-03**
- (52) **U.S. Cl.** ..... **D14/258**
- (58) **Field of Classification Search** ..... D14/157, D14/217, 224, 257-258; 360/4; 369/75.11; 720/658, 691; 455/344, 575.1; 248/27.1, 248/27.3, 558

See application file for complete search history.

(56) **References Cited**

**U.S. PATENT DOCUMENTS**

- 5,106,039 A 4/1992 Gross
- 5,467,947 A 11/1995 Quilling, II
- D401,591 S 11/1998 Jones, Jr. et al.
- D418,838 S 1/2000 Jones, Jr. et al.
- D481,378 S 10/2003 Quilling, II et al.
- D481,707 S 11/2003 Quilling, II et al.
- D481,708 S 11/2003 Quilling, II et al.
- D482,023 S 11/2003 Quilling, II et al.
- D482,024 S 11/2003 Quilling, II et al.
- 6,651,936 B2 11/2003 Upson et al.
- D483,027 S 12/2003 Quilling, II et al.
- D484,495 S 12/2003 Quilling, II et al.
- D485,260 S 1/2004 Quilling, II et al.
- D488,462 S 4/2004 Quilling, II et al.
- D492,287 S 6/2004 Quilling, II
- D492,288 S 6/2004 Quilling, II
- D492,668 S 7/2004 Quilling, II
- D496,028 S 9/2004 Quilling, II

**OTHER PUBLICATIONS**

Metra The Installer's Choice, Autosound Installation Products (metraonline.com), pp. 1-143 (2008).

*Primary Examiner* — Nanda Bondade

(74) *Attorney, Agent, or Firm* — Fitzpatrick, Cella, Harper & Scinto

(57) **CLAIM**

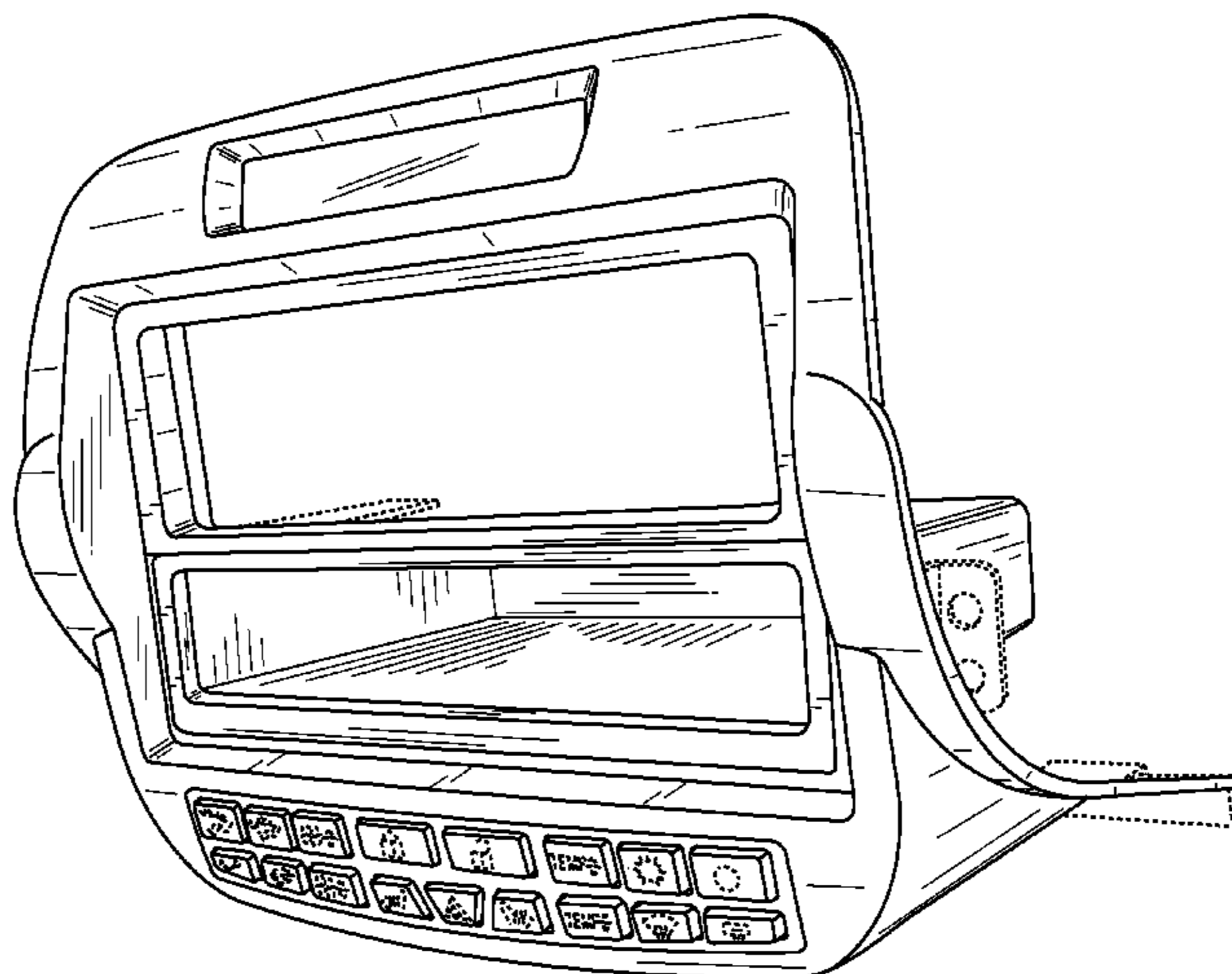
We claim the ornamental design for an ISO/DIN head unit provision with pocket, as shown and described.

**DESCRIPTION**

FIG. 1 is a right front perspective view of an ISO/DIN head unit provision with pocket showing our design; FIG. 2 is a front elevational view of FIG. 1; FIG. 3 is a rear elevational view of FIG. 1; FIG. 4 is a right side elevation view of FIG. 1; FIG. 5 is a top plan view of FIG. 1; FIG. 6 is a bottom plan view of FIG. 1; and, FIG. 7 is a view of FIG. 1 with the DIN radio support and pocket removed for clarity.

The broken line showing on the drawing disclosure is for illustrative purposes only and forms no part of the claimed design.

**1 Claim, 7 Drawing Sheets**



# US D639,794 S

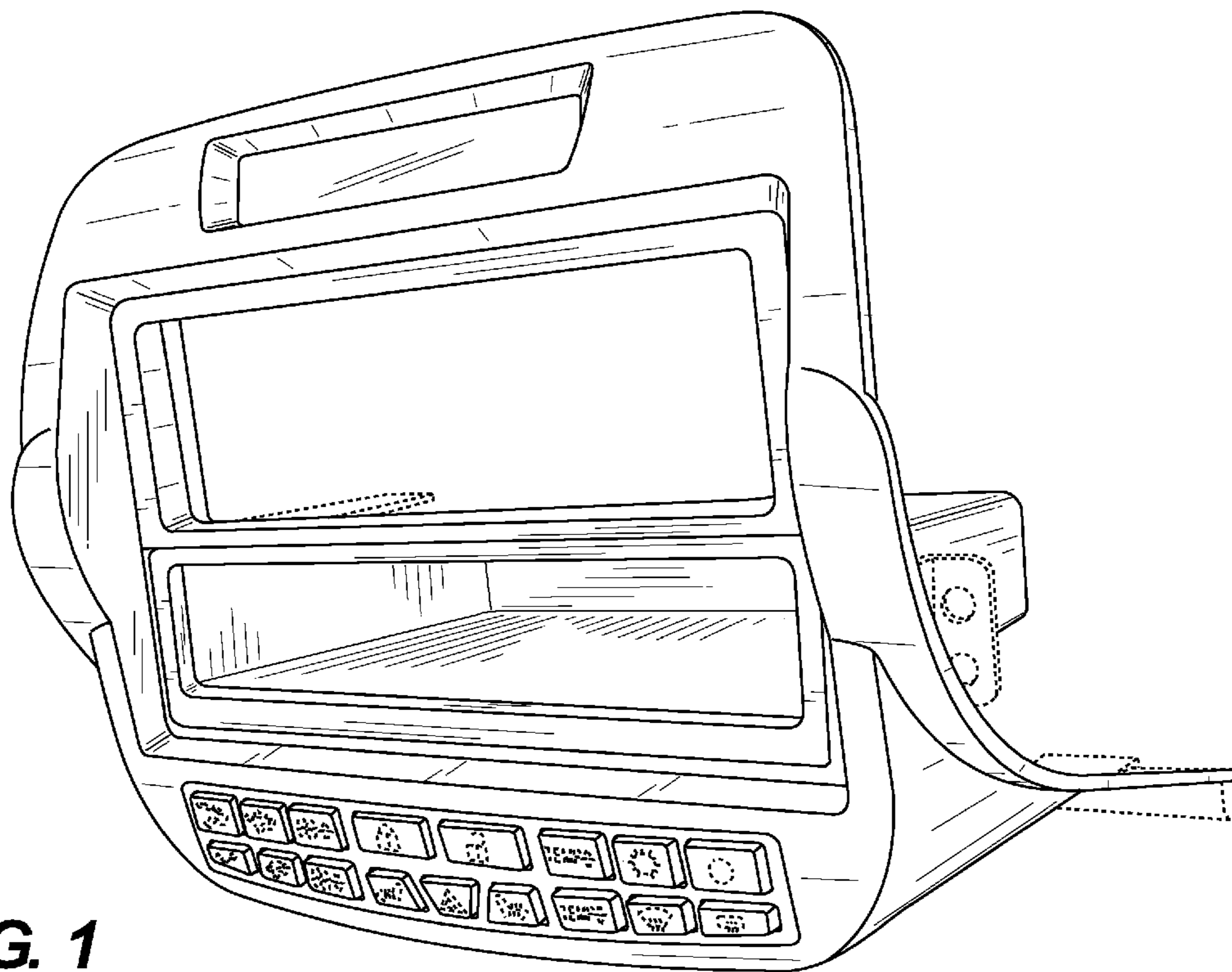
Page 2

---

## U.S. PATENT DOCUMENTS

D540,785 S	4/2007	Quilling, II		D582,912 S	12/2008	Quilling, II
7,201,356 B2 *	4/2007	Huang .....	248/27.3	D583,809 S	12/2008	Fiore
D545,661 S	7/2007	Quilling, II		D584,725 S	1/2009	Fiore, IV
D545,815 S	7/2007	Quilling, II		D602,013 S	10/2009	Quilling, II
D555,645 S	11/2007	Quilling, II		D602,483 S	10/2009	Fiore, IV
D555,646 S	11/2007	Quilling, II		D602,929 S	10/2009	Quilling, II
D555,647 S	11/2007	Quilling, II		D602,930 S	10/2009	Quilling, II
D566,701 S	4/2008	Quilling, II		D603,390 S	11/2009	Quilling, II
7,430,110 B2	9/2008	Quilling, II		D604,286 S	11/2009	Fiore, IV
D581,408 S	11/2008	Fiore, IV		D610,580 S	2/2010	Fiore, IV
D582,908 S	12/2008	Quilling		D611,939 S	3/2010	Quilling, II

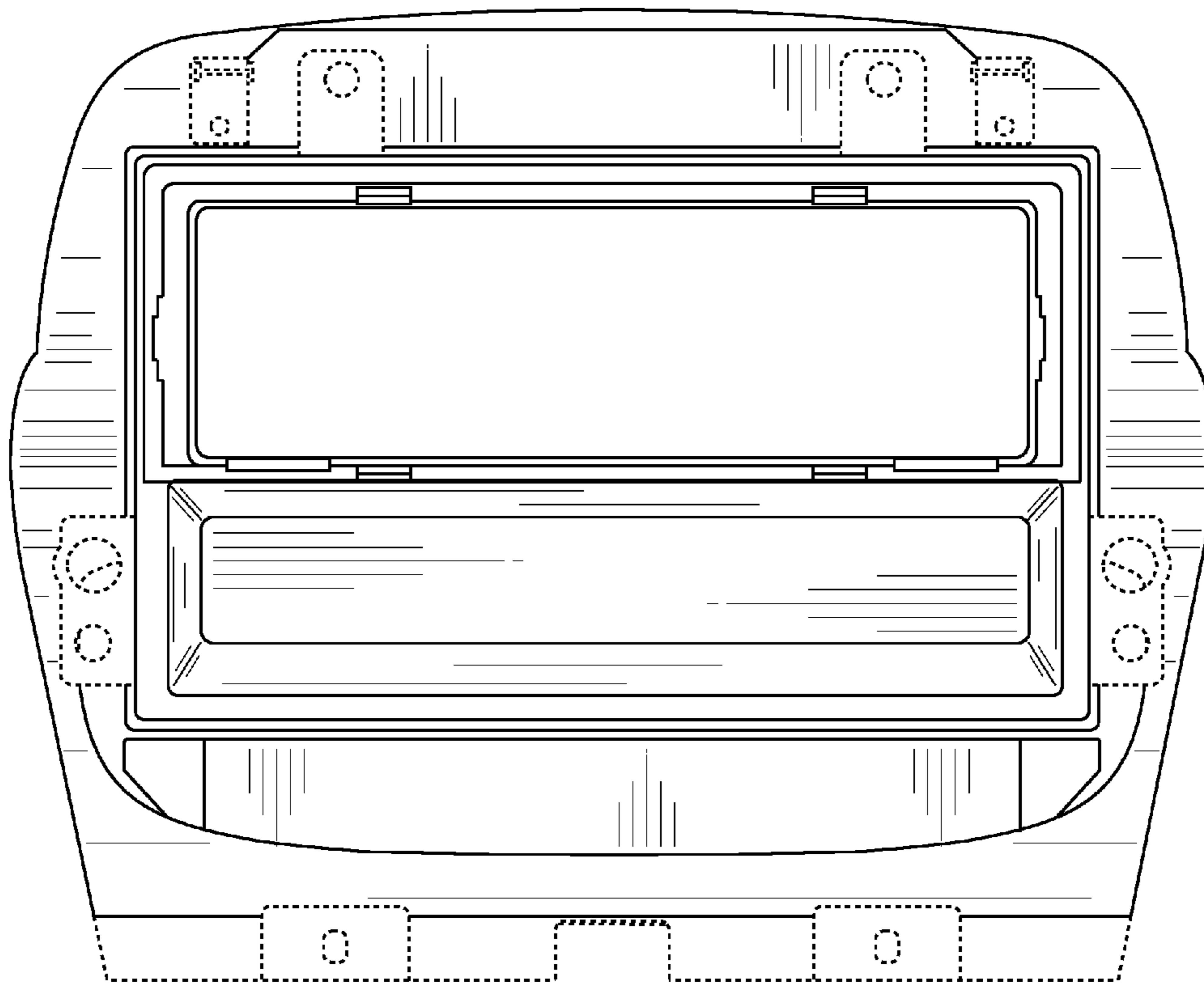
\* cited by examiner



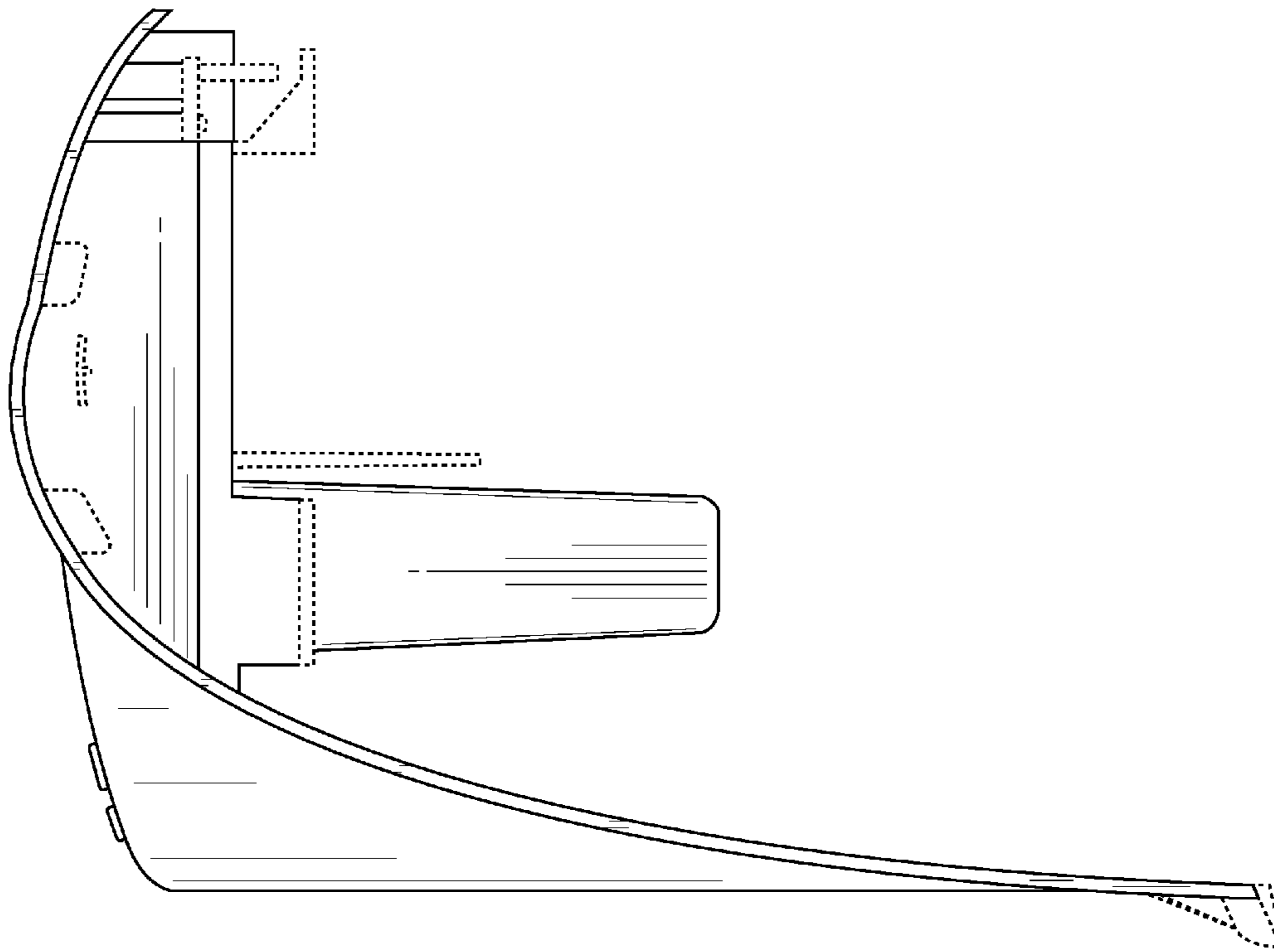
**FIG. 1**



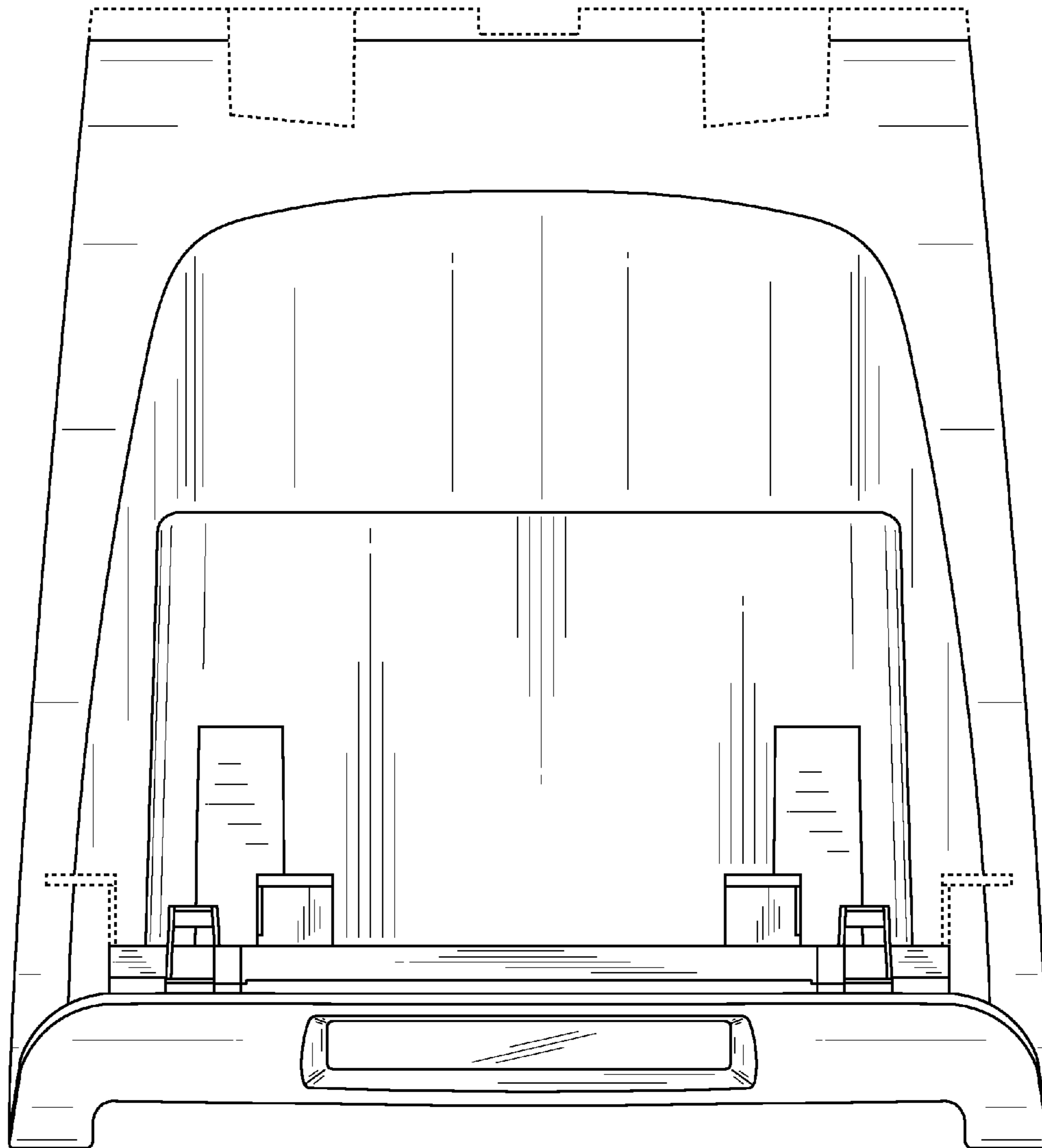
**FIG. 2**



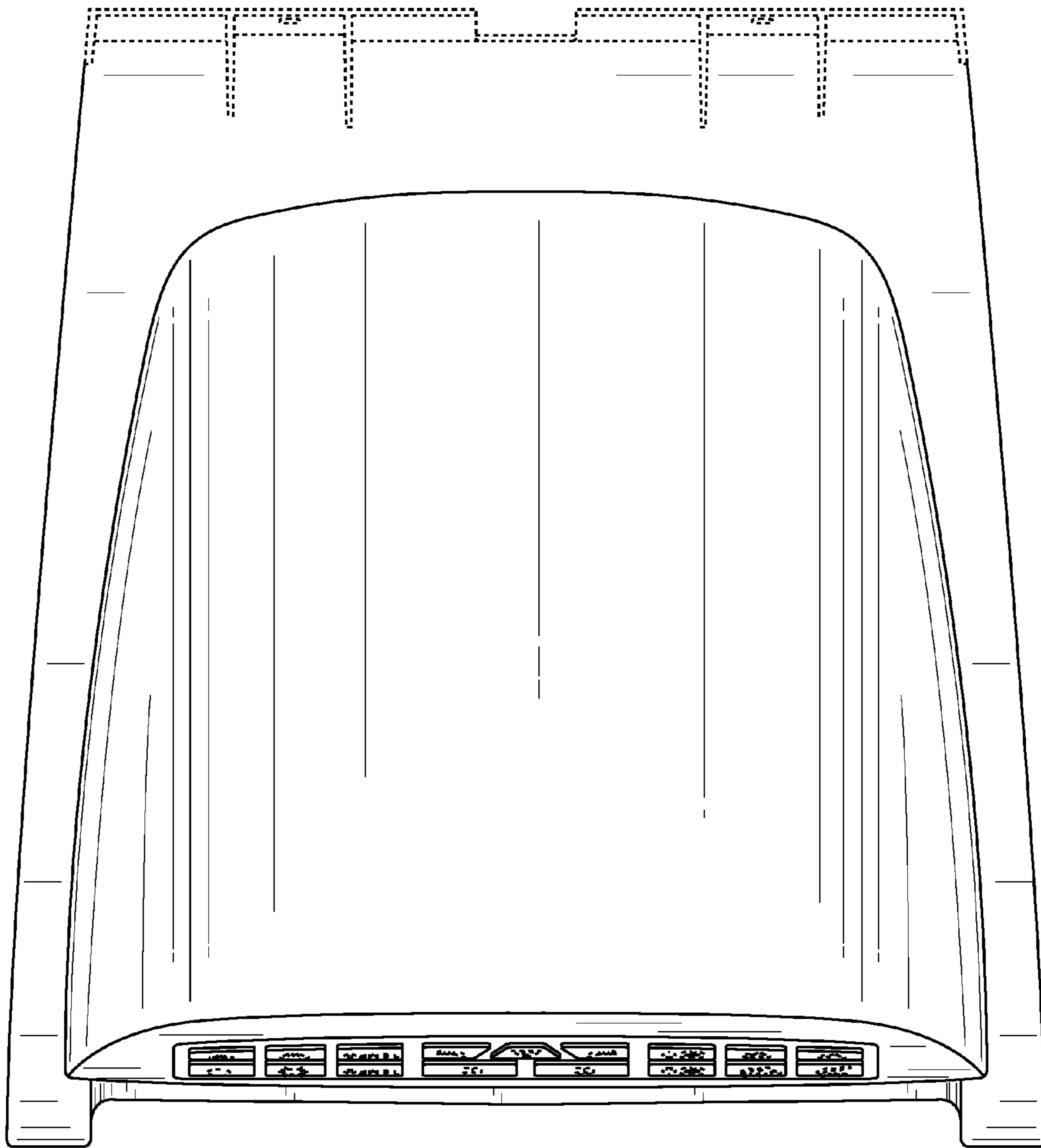
**FIG. 3**



**FIG. 4**

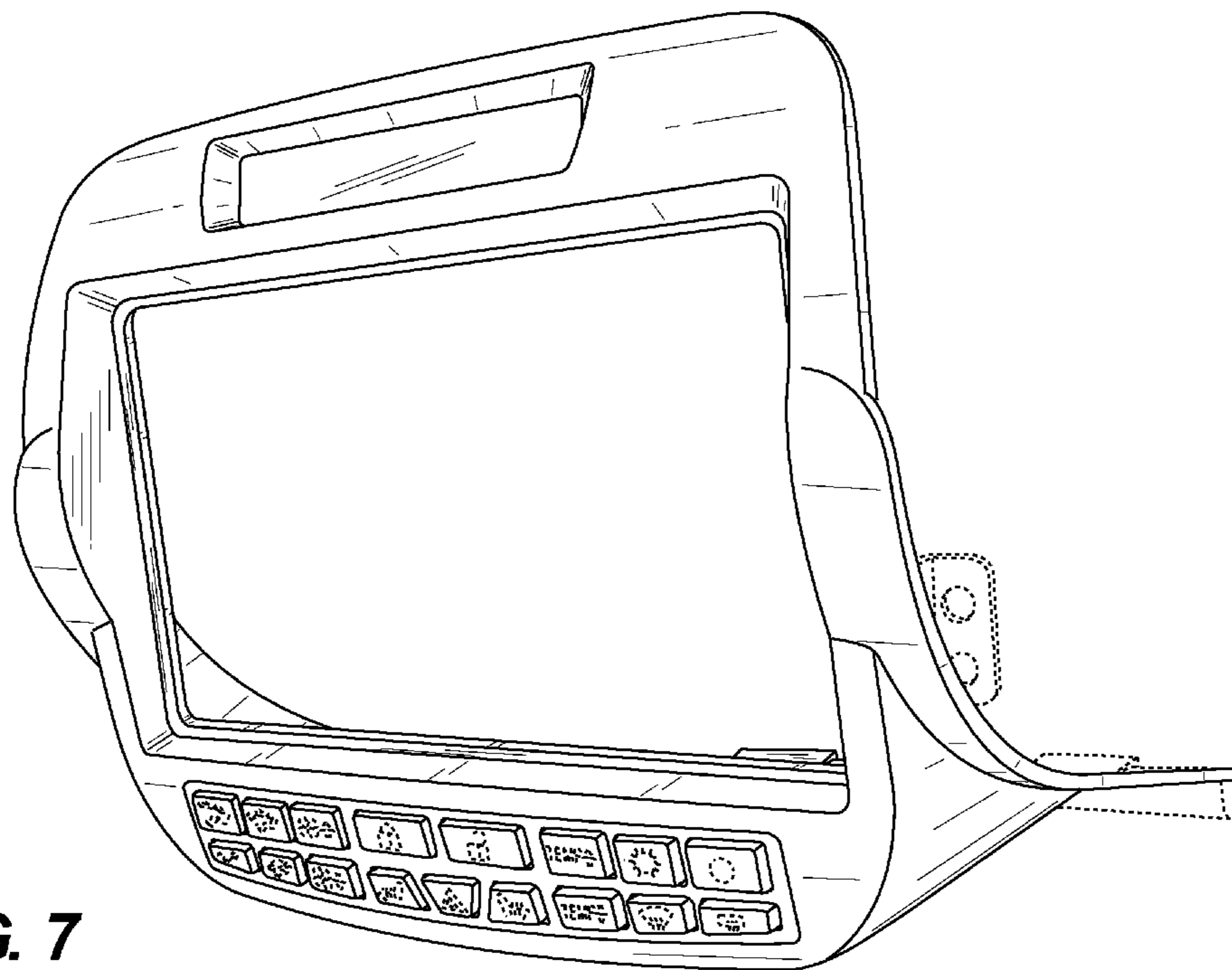


**FIG. 5**



**FIG. 6**





**FIG. 7**