



US00D639769S

(12) **United States Design Patent**
Wang

(10) **Patent No.:** **US D639,769 S**
(45) **Date of Patent:** **** Jun. 14, 2011**

(54) **HANDSET**
(75) Inventor: **Jing-Jackie Wang**, Beijing (CN)
(73) Assignee: **Nokia Corporation**, Espoo (FI)
(**) Term: **14 Years**

D628,178 S 11/2010 Cai
D628,182 S * 11/2010 Hirano D14/138 AA
D628,187 S * 11/2010 Huang D14/138 AA
D629,376 S 12/2010 Choi et al.

(Continued)

(21) Appl. No.: **29/379,353**
(22) Filed: **Nov. 18, 2010**

OTHER PUBLICATIONS

Nokia X1-00 telephone, announced Mar. 2011, [online], [site visited Mar. 25, 2011]. Available from Internet, <URL: http://www.gsmarena.com>.*

(Continued)

(51) **LOC (9) Cl.** **14-03**
(52) **U.S. Cl.** **D14/138 AA**
(58) **Field of Classification Search** D14/138 AA,
D14/496, 341, 345, 346, 203.3, 203.4, 203.7,
D14/138 AD, 138 R, 147, 218, 137; 455/575.1,
455/556.2, 575.3, 575.4; D21/517; 379/433.01,
379/433.04, 433.11, 433.12, 433.13; D13/168
See application file for complete search history.

Primary Examiner — Jeff D Asch
(74) *Attorney, Agent, or Firm* — Banner & Witcoff, Ltd.

(57) **CLAIM**
The ornamental design for a handset, as shown and described.

(56) **References Cited**

DESCRIPTION

U.S. PATENT DOCUMENTS

D538,770 S *	3/2007	Lyles	D14/138 AA
D554,100 S *	10/2007	Kim et al.	D14/138 AA
D555,626 S *	11/2007	Son et al.	D14/138 AA
D559,219 S *	1/2008	Suk et al.	D14/138 AA
D560,645 S *	1/2008	Park	D14/138 AA
D574,800 S *	8/2008	Stillerman	D14/138 AA
D579,909 S *	11/2008	Huang et al.	D14/138 AA
D602,455 S *	10/2009	Lee et al.	D14/138 AA
D603,353 S *	11/2009	Park et al.	D14/138 AA
D606,956 S *	12/2009	Wang et al.	D14/138 AA
D608,333 S	1/2010	Wang		
D608,355 S	1/2010	Fahlgren et al.		
D609,665 S *	2/2010	Chen et al.	D14/138 AA
D609,702 S	2/2010	He		
D610,116 S *	2/2010	He	D14/138 AA
D610,119 S *	2/2010	Kim et al.	D14/138 AA
D610,121 S *	2/2010	Lee et al.	D14/138 AA
D610,564 S	2/2010	Schellen		
D610,566 S *	2/2010	Chang	D14/138 AA
D612,829 S	3/2010	Leith et al.		
D617,300 S *	6/2010	Tzeng et al.	D14/138 AA
D622,686 S *	8/2010	Muspratt-Williams et al.	D14/138 AA
D626,934 S *	11/2010	Lee et al.	D14/138 AA
D627,320 S	11/2010	Gu et al.		

FIG. 1 is a perspective view of a handset showing my new design;
FIG. 2 is a front view thereof;
FIG. 3 is a rear view thereof;
FIG. 4 is a left side view thereof;
FIG. 5 is a right side view thereof;
FIG. 6 is a top view thereof;
FIG. 7 is a bottom view thereof;
FIG. 8 is a perspective view of a second embodiment of a handset showing my new design;
FIG. 9 is a front view thereof;
FIG. 10 is a rear view thereof;
FIG. 11 is a left side view thereof;
FIG. 12 is a right side view thereof;
FIG. 13 is a top view thereof; and,
FIG. 14 is a bottom view thereof.
The broken lines shown in FIGS. 1-7 that are immediately adjacent to the shaded areas, and define unshaded regions, represent the bounds of the embodiment in which they are shown; the broken lines form no part of the embodiment in which they are shown.

1 Claim, 10 Drawing Sheets

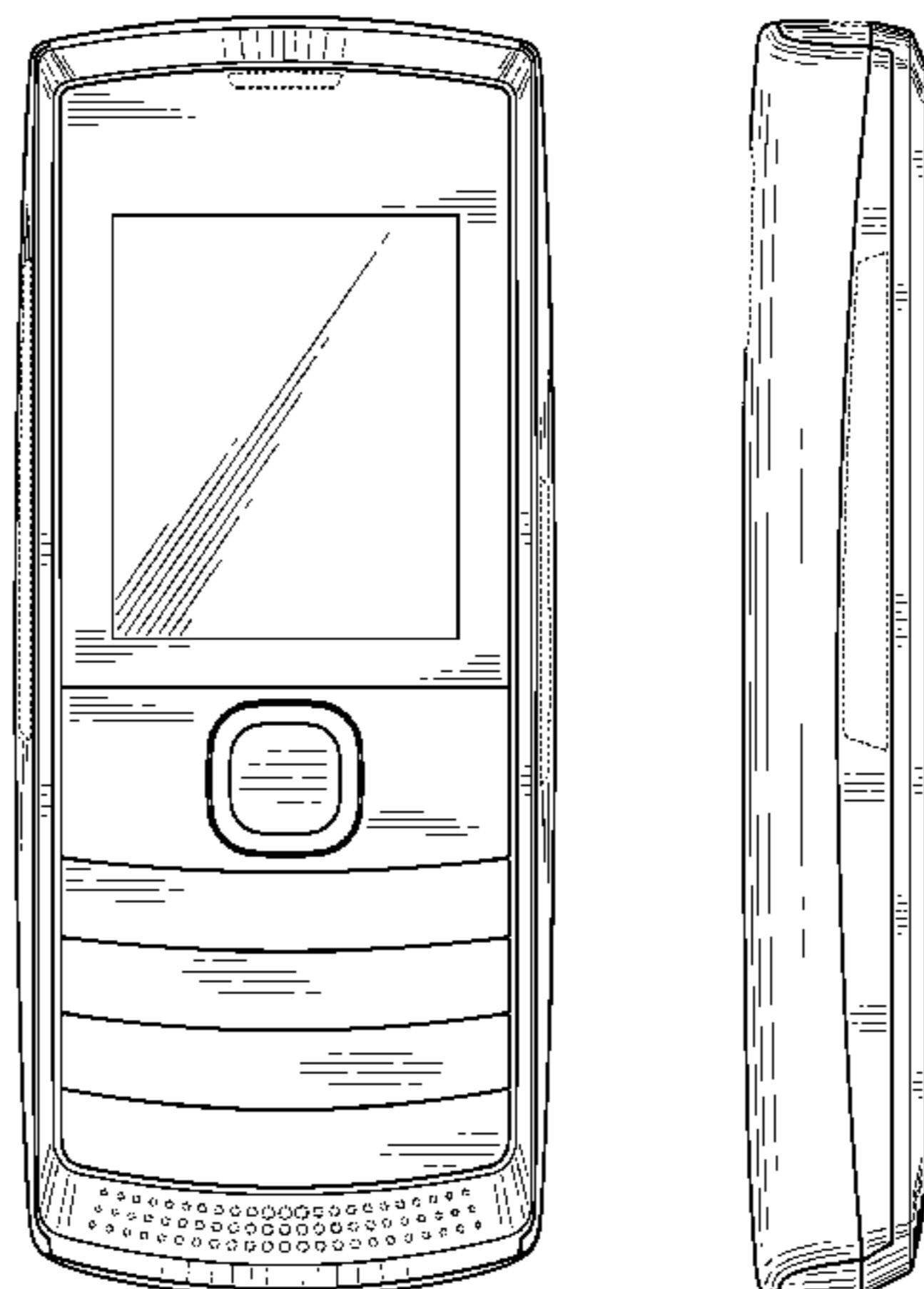

U.S. PATENT DOCUMENTS

D630,609 S 1/2011 Yang
D631,453 S 1/2011 Chen
D632,662 S * 2/2011 Ng D14/138 AA
D634,289 S * 3/2011 Wang D14/138 AA
D635,110 S * 3/2011 Mota Veiga et al. .. D14/138 AA

OTHER PUBLICATIONS

Sony Ericsson Cedar telephone, announced Jun. 2010, [online], [site visited Mar. 25, 2011]. Available from Internet, <URL: <http://www.gsmarena.com>>.*

Samsung Z170 telephone, announced Jul. 2007, [online], [site visited Mar. 25, 2011]. Available from Internet, <URL: <http://www.gsmarena.com>>.*

LG S310 telephone, announced Nov. 2010, [online], [site visited Mar. 25, 2011]. Available from Internet, <URL: <http://www.gsmarena.com>>.*

Philips X100 telephone, announced Feb. 2010, [online], [site visited Mar. 25, 2011]. Available from Internet, <URL: <http://www.gsmarena.com>>.*

Philips X603 telephone, announced Jan. 2010, [online], [site visited Mar. 25, 2011]. Available from Internet, <URL: <http://www.gsmarena.com>>.*

LG KP320 telephone, announced May 2008, [online], [site visited Mar. 25, 2011]. Available from Internet, <URL: <http://www.gsmarena.com>>.*

Samsung U800 Soul b telephone, announced May 2008, [online], [site visited Mar. 25, 2011]. Available from Internet, <URL: <http://www.gsmarena.com>>.*

Nokia X5 TD-SCMA telephone, announced Apr. 2010, [online], [site visited Mar. 25, 2011]. Available from Internet, <URL: <http://www.gsmarena.com>>.*

Nokia X2 telephone, announced Apr. 2011, [online], [site visited Mar. 25, 2011]. Available from Internet, <URL: <http://www.gsmarena.com>>.*

Nokia X3-02 Touch and Type telephone, announced Aug. 2010, [online], [site visited Mar. 25, 2011]. Available from Internet, <URL: <http://www.gsmarena.com>>.*

* cited by examiner

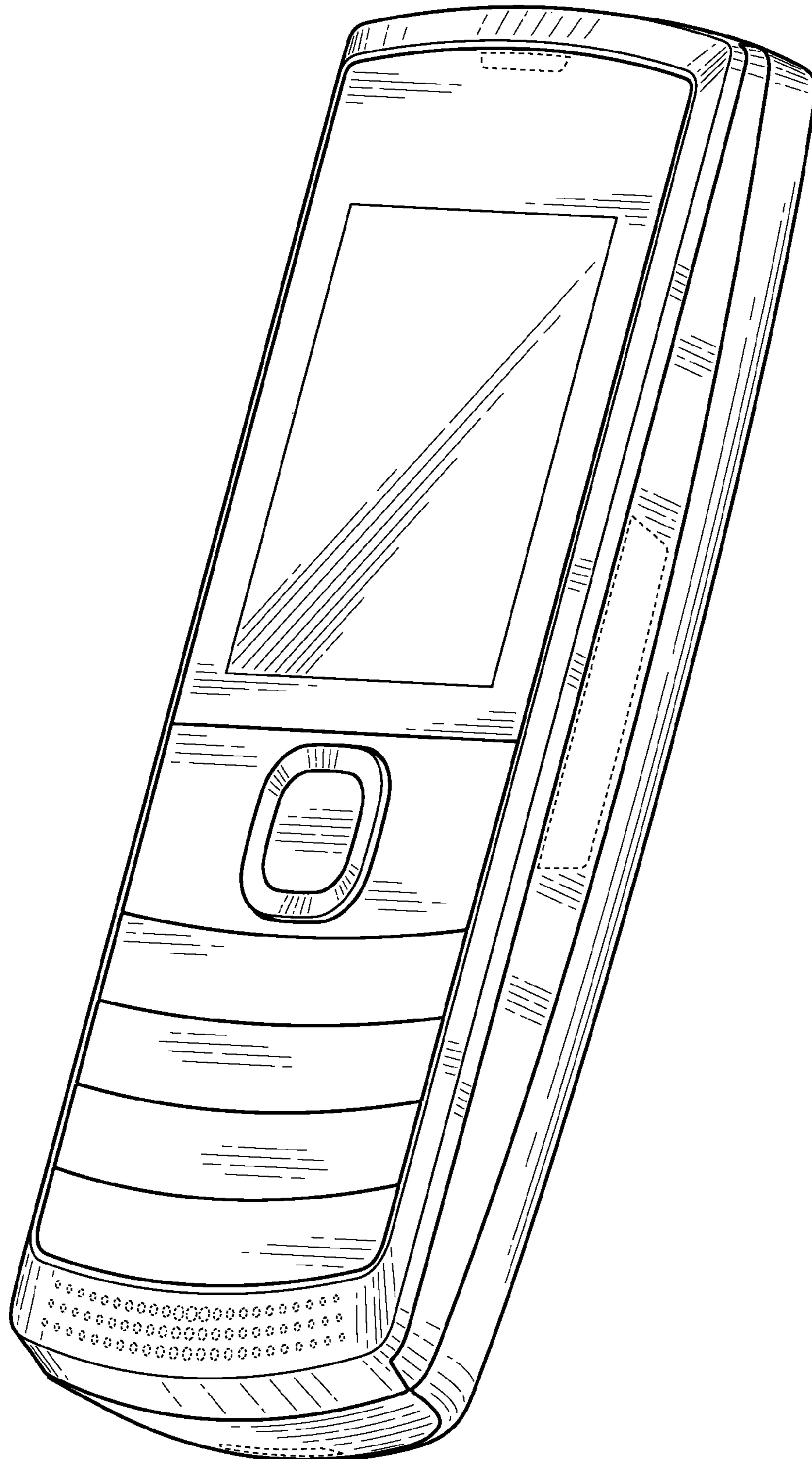

FIG. 1

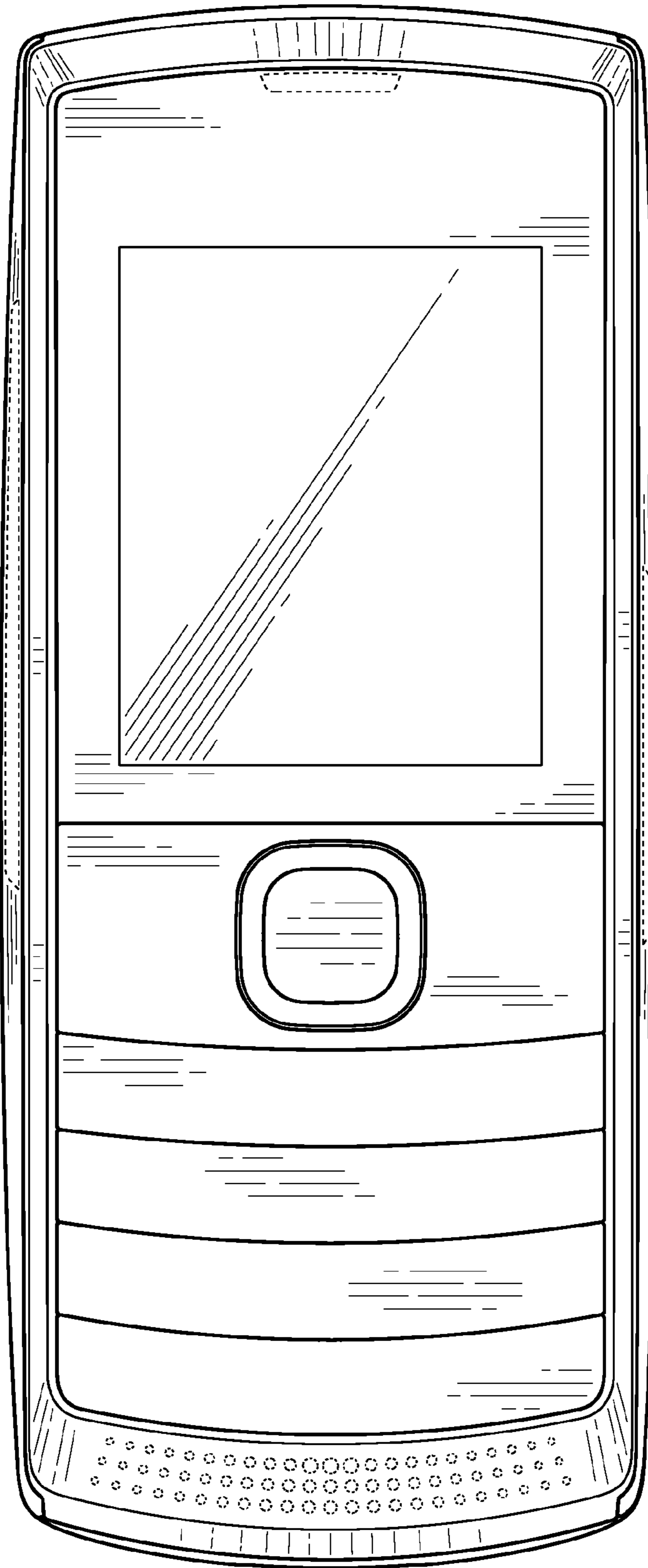

FIG. 2

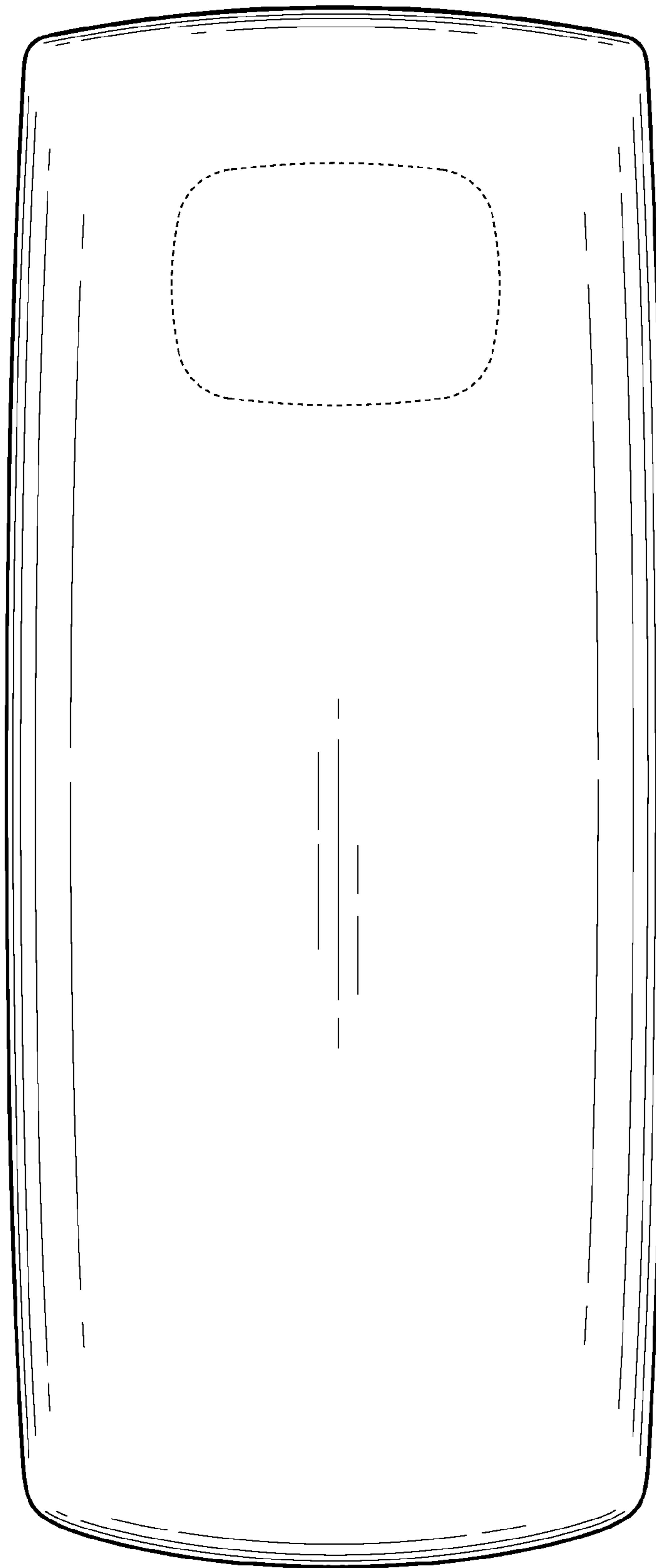

FIG. 3

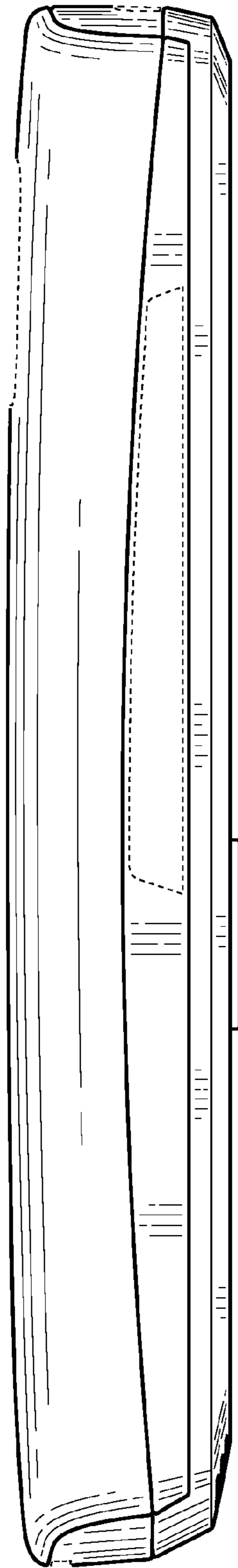

FIG. 4

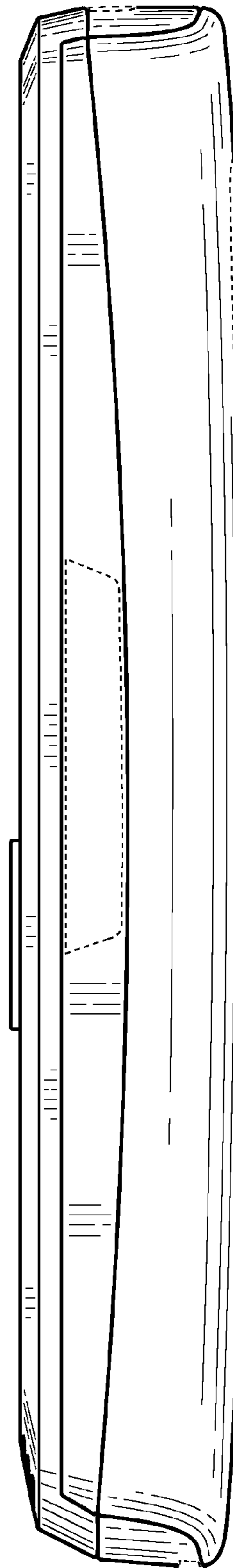

FIG. 5

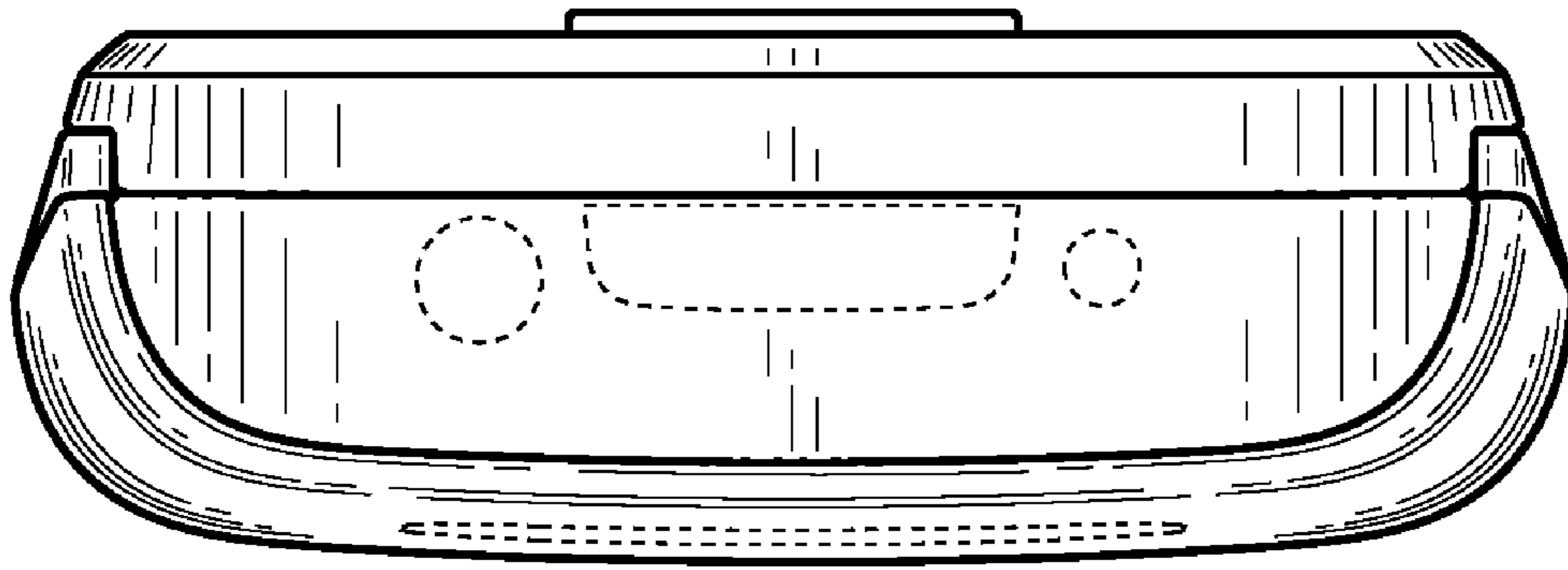

FIG. 6

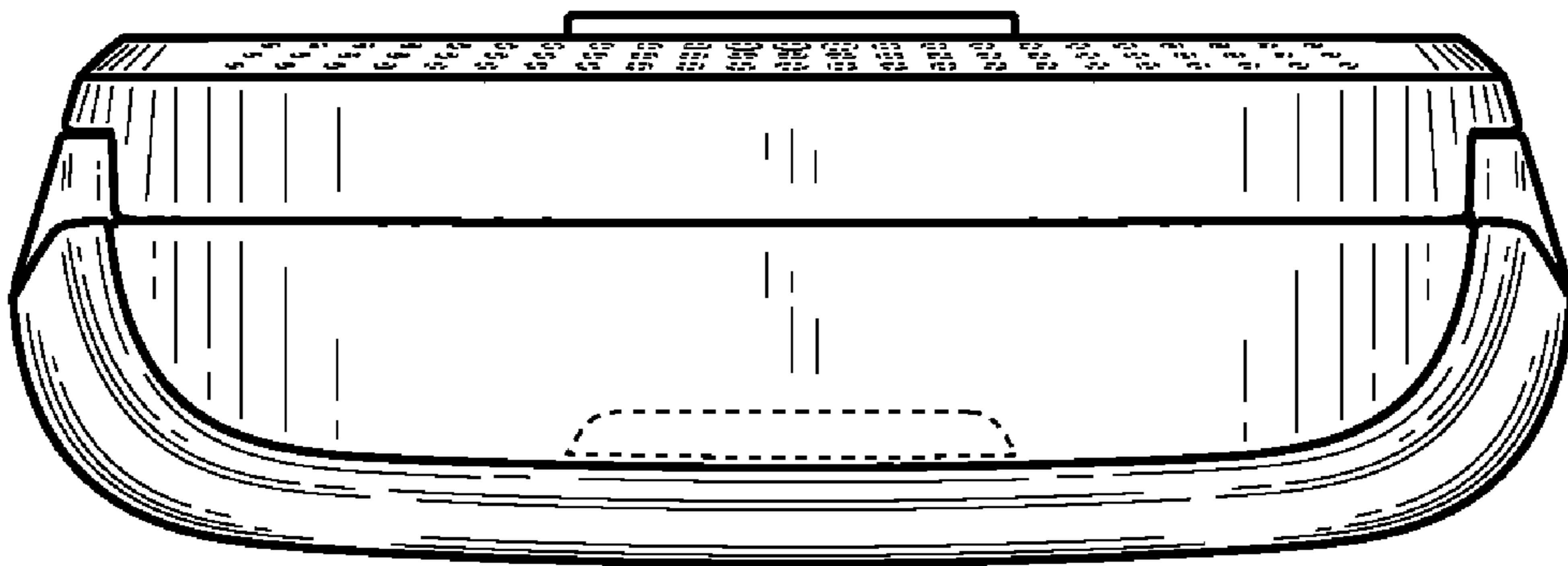

FIG. 7

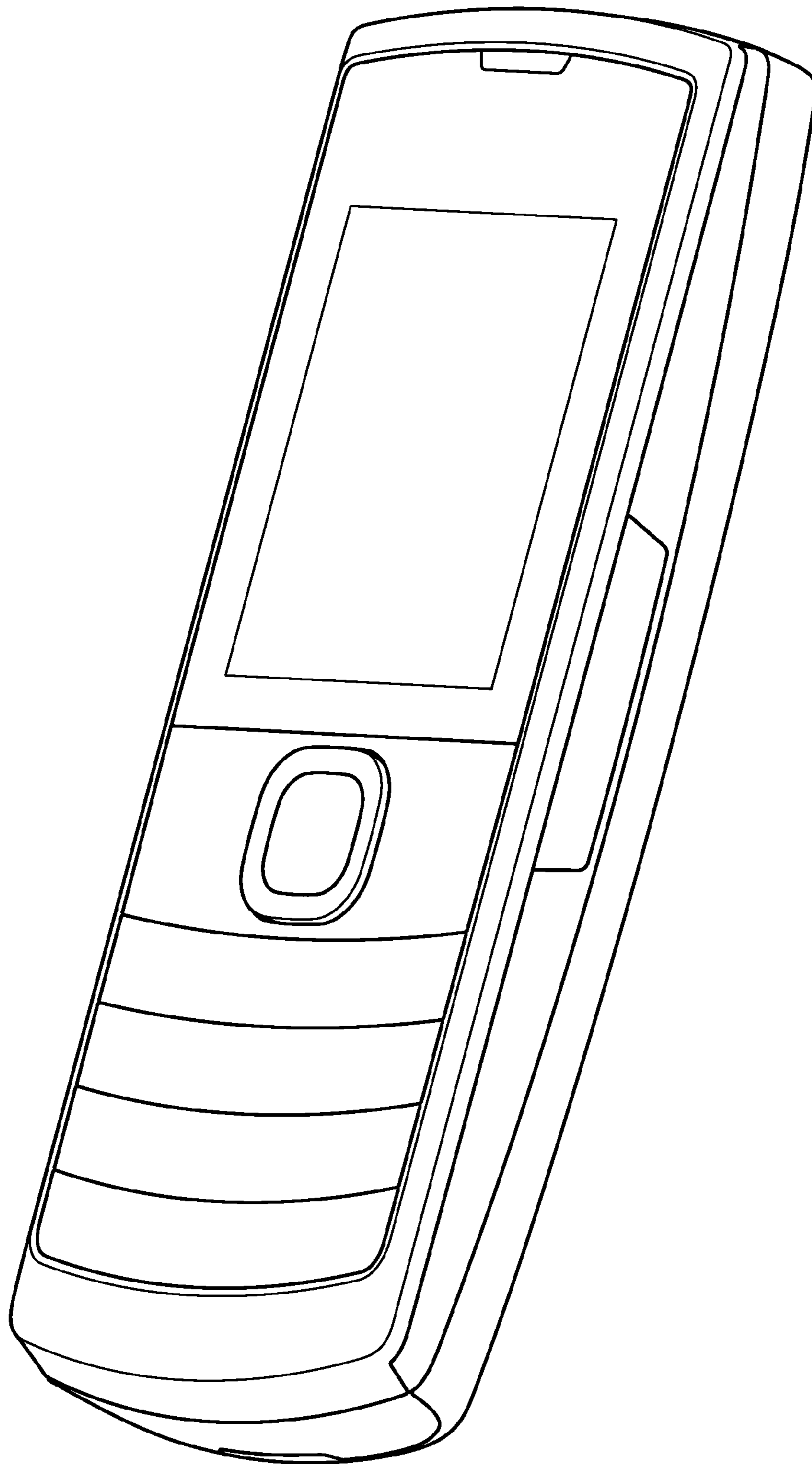

FIG. 8

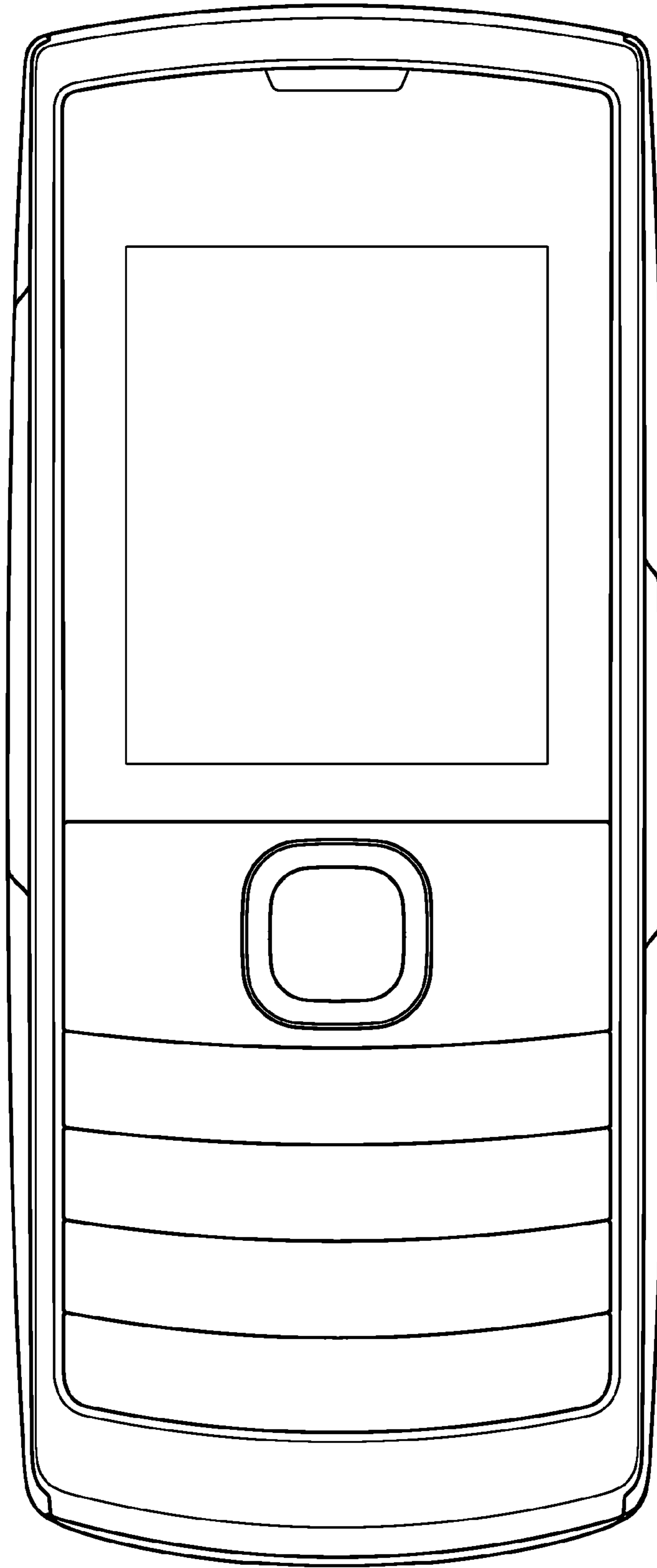

FIG. 9



FIG. 10

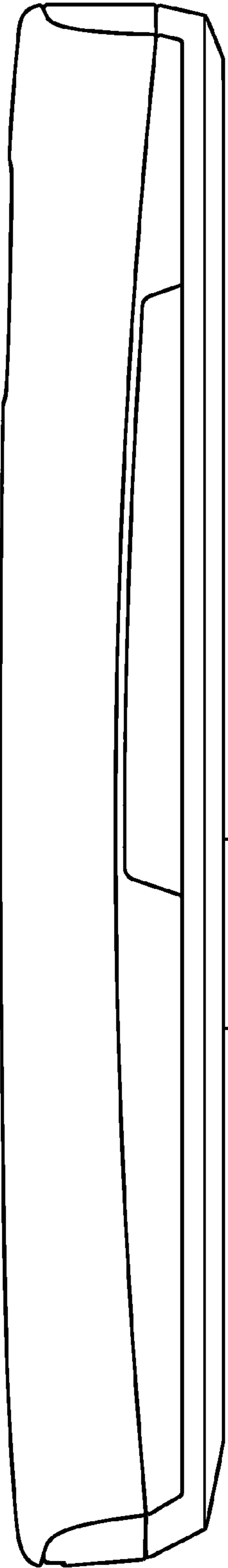

FIG. 11

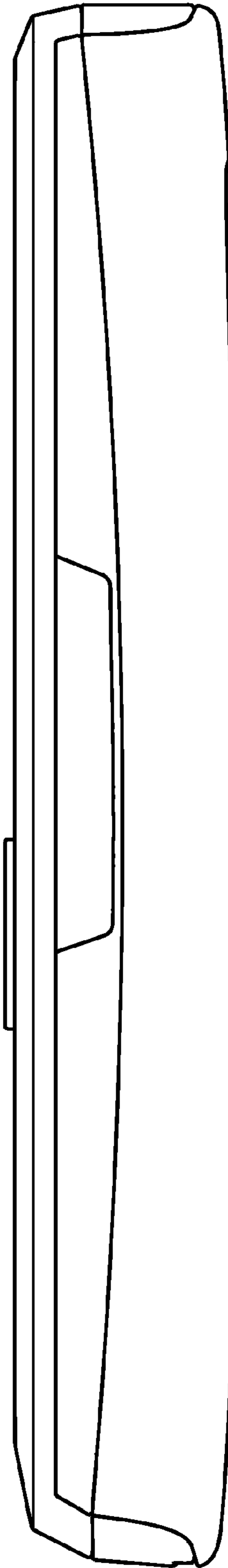

FIG. 12

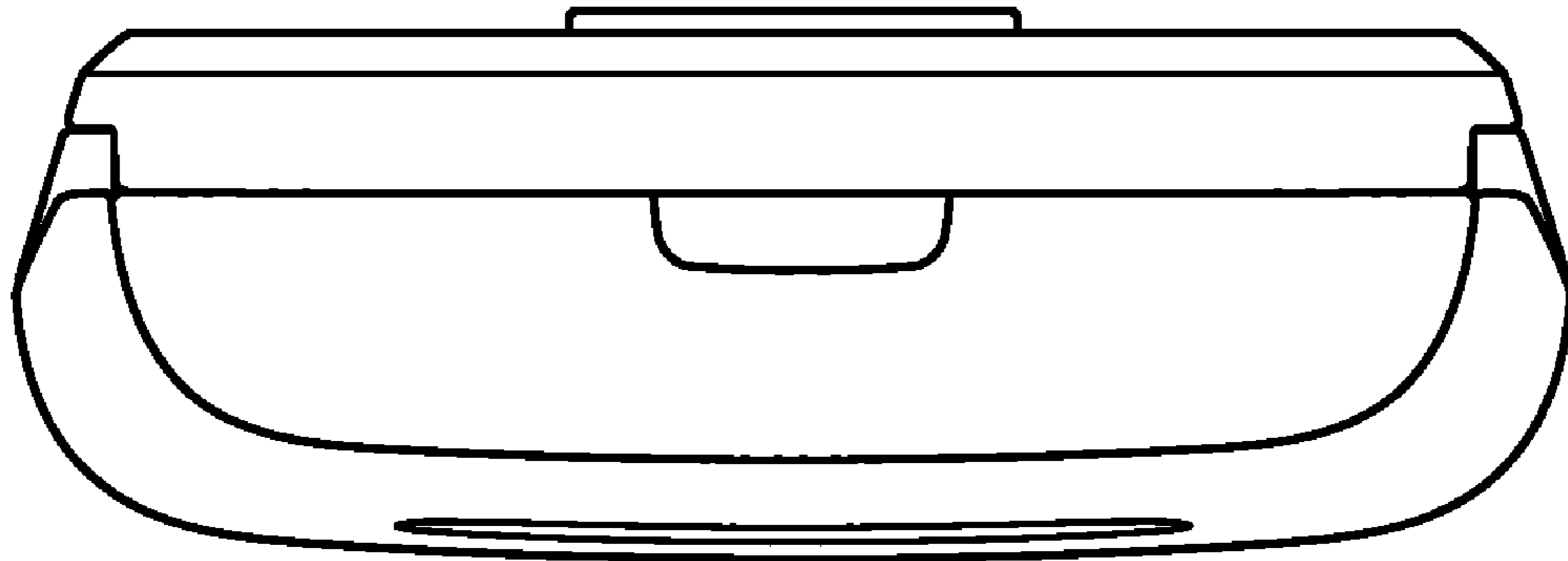

FIG. 13

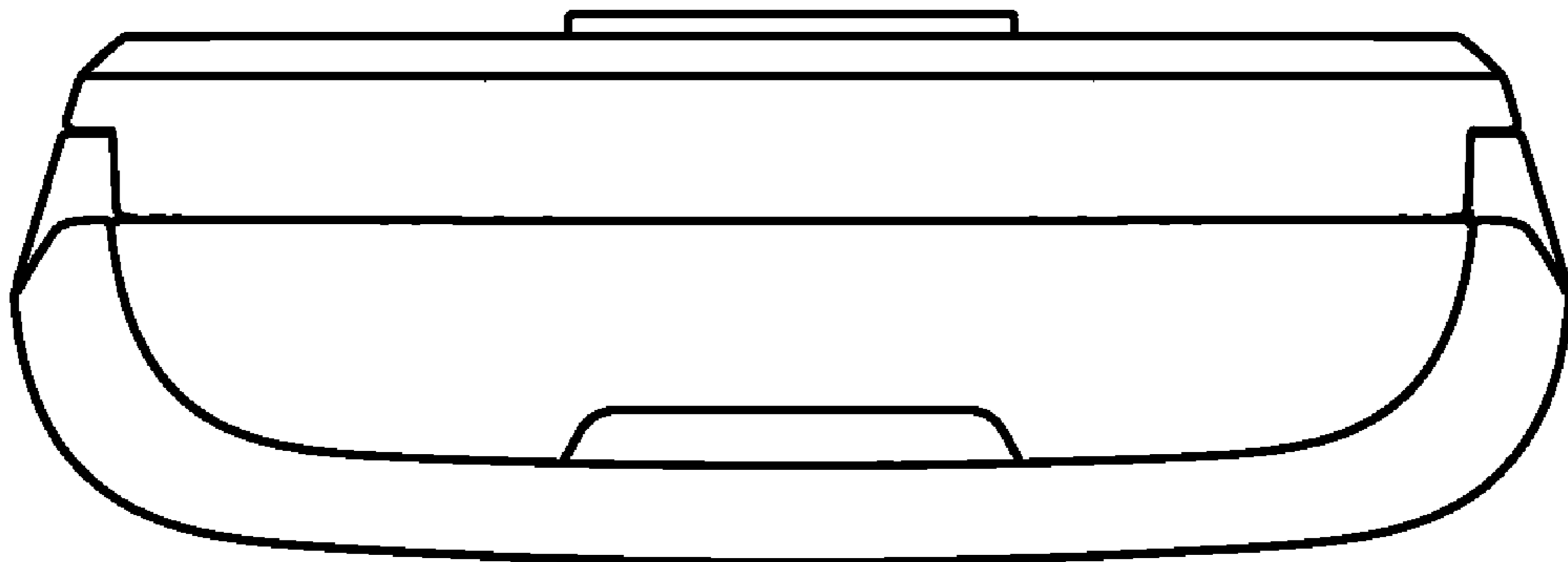

FIG. 14