

US00D639766S

(12) **United States Design Patent**
Han et al.

(10) **Patent No.:** **US D639,766 S**

(45) **Date of Patent:** **** Jun. 14, 2011**

(54) **MOBILE PHONE**

(75) Inventors: **Woo-Seung Han**, Seoul (KR);
Young-Keun Lee, Seoul (KR)

(73) Assignee: **Samsung Electronics Co., Ltd.** (KR)

(**) Term: **14 Years**

(21) Appl. No.: **29/371,054**

(22) Filed: **Sep. 30, 2010**

(30) **Foreign Application Priority Data**

Aug. 11, 2010 (KR) 30-2010-0034901

(51) **LOC (9) Cl.** **14-03**

(52) **U.S. Cl.** **D14/138 AD**

(58) **Field of Classification Search** D14/138 R,
D14/138 AD, 138 AC, 138 C, 138 G, 191,
D14/203.1–203.8, 496, 138 AA, 138 AB,
D14/137, 147, 218, 341–347, 247–248; D10/65,
D10/78, 104; D13/168; D18/7; 455/566,
455/575.1, 575.3, 575.4

See application file for complete search history.

(56) **References Cited**

U.S. PATENT DOCUMENTS

| | | | | | | |
|----------|---|---|---------|-------------|-------|------------|
| D479,215 | S | * | 9/2003 | Yokoyama | | D14/138 AD |
| D498,754 | S | * | 11/2004 | Blyth | | D14/341 |
| D543,174 | S | * | 5/2007 | Kim | | D14/138 AD |
| D543,176 | S | * | 5/2007 | Hyun et al. | | D14/138 G |
| D560,193 | S | * | 1/2008 | Sung et al. | | D14/138 AD |
| D565,533 | S | * | 4/2008 | Kim et al. | | D14/138 AD |
| D572,695 | S | * | 7/2008 | Tu | | D14/138 AD |
| D607,865 | S | * | 1/2010 | Lee et al. | | D14/138 AD |
| D608,331 | S | * | 1/2010 | Kim et al. | | D14/138 AC |
| D611,025 | S | * | 3/2010 | Yu | | D14/138 G |
| D615,055 | S | * | 5/2010 | Lee et al. | | D14/138 G |
| D615,950 | S | * | 5/2010 | Cha et al. | | D14/138 AD |
| D616,854 | S | * | 6/2010 | Kim et al. | | D14/138 AD |
| D618,652 | S | * | 6/2010 | Oh et al. | | D14/138 AD |
| D618,653 | S | * | 6/2010 | Kim et al. | | D14/138 AD |

| | | | | | | |
|--------------|----|---|---------|-------------|-------|------------|
| D619,984 | S | * | 7/2010 | Han et al. | | D14/138 AD |
| D619,986 | S | * | 7/2010 | Kim et al. | | D14/138 AD |
| D622,691 | S | * | 8/2010 | Kim et al. | | D14/138 G |
| D624,039 | S | * | 9/2010 | Cha et al. | | D14/138 AD |
| D628,975 | S | * | 12/2010 | Jang | | D14/138 G |
| D629,375 | S | * | 12/2010 | Han et al. | | D14/138 AD |
| D629,776 | S | * | 12/2010 | Lee et al. | | D14/138 AD |
| 2005/0190291 | A1 | * | 9/2005 | Kota et al. | | 348/376 |
| 2006/0093133 | A1 | * | 5/2006 | Park et al. | | 379/433.12 |
| 2006/0187212 | A1 | * | 8/2006 | Park et al. | | 345/169 |
| 2007/0218963 | A1 | * | 9/2007 | Kim | | 455/575.4 |

OTHER PUBLICATIONS

Samsung A817 Solstice II, announced Nov. 2010, [online], [retrieved on Jan. 6, 2011]. Retrieved from Internet ,<URL: <http://www.gsmarena.com>>.*

(Continued)

Primary Examiner — Bridget L Eland

(74) *Attorney, Agent, or Firm* — NSIP Law

(57) **CLAIM**

The ornamental design for a mobile phone, as shown and described.

DESCRIPTION

FIG. 1 is a perspective view of a mobile phone;
FIG. 2 is a front view of the mobile phone of FIG. 1;
FIG. 3 is a rear view of the mobile phone of FIG. 1;
FIG. 4 is a left-side view of the mobile phone of FIG. 1;
FIG. 5 is a right-side view of the mobile phone of FIG. 1;
FIG. 6 is a top plan view of the mobile phone of FIG. 1;
FIG. 7 is a bottom plan view of the mobile phone of FIG. 1;
and,
FIG. 8 is an open view of the mobile phone of FIG. 1.
The evenly spaced broken lines immediately adjacent the shaded areas represent the bounds of the claimed design while all other broken lines are directed to environment and are for illustrative purposes only; the broken lines form no part of the claimed design.

1 Claim, 6 Drawing Sheets

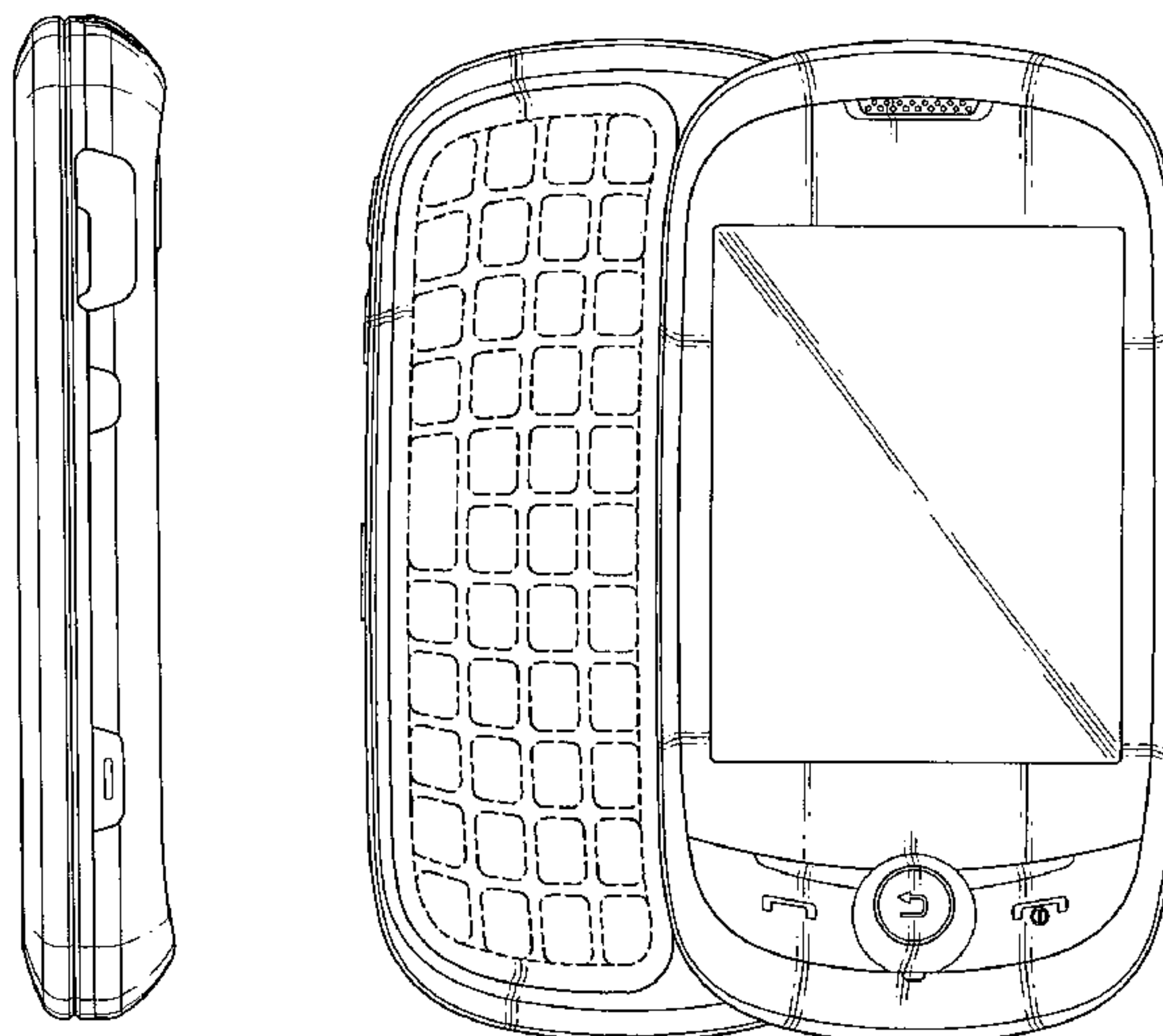

OTHER PUBLICATIONS

Acer M900, announced Feb. 2009, [online], [retrieved on Oct. 28, 2009]. Retrieved from Internet ,<URL: <http://www.gsmarena.com>>.*

Samsung Impression, announced Mar. 2009, [online], [retrieved on Apr. 16, 2009]. Retrieved from Internet ,<URL: <http://www.gsmarena.com>>.*

LG GW620, announced Sep. 2009, [online], [retrieved on Sep. 14, 2009]. Retrieved from Internet ,<URL: <http://www.gsmarena.com>>.*

Samsung A927 Flight II, announced Aug. 2010, [online], [retrieved on Feb. 1, 2011]. Retrieved from Internet ,<URL: <http://www.gsmarena.com>>.*

* cited by examiner

FIG. 1

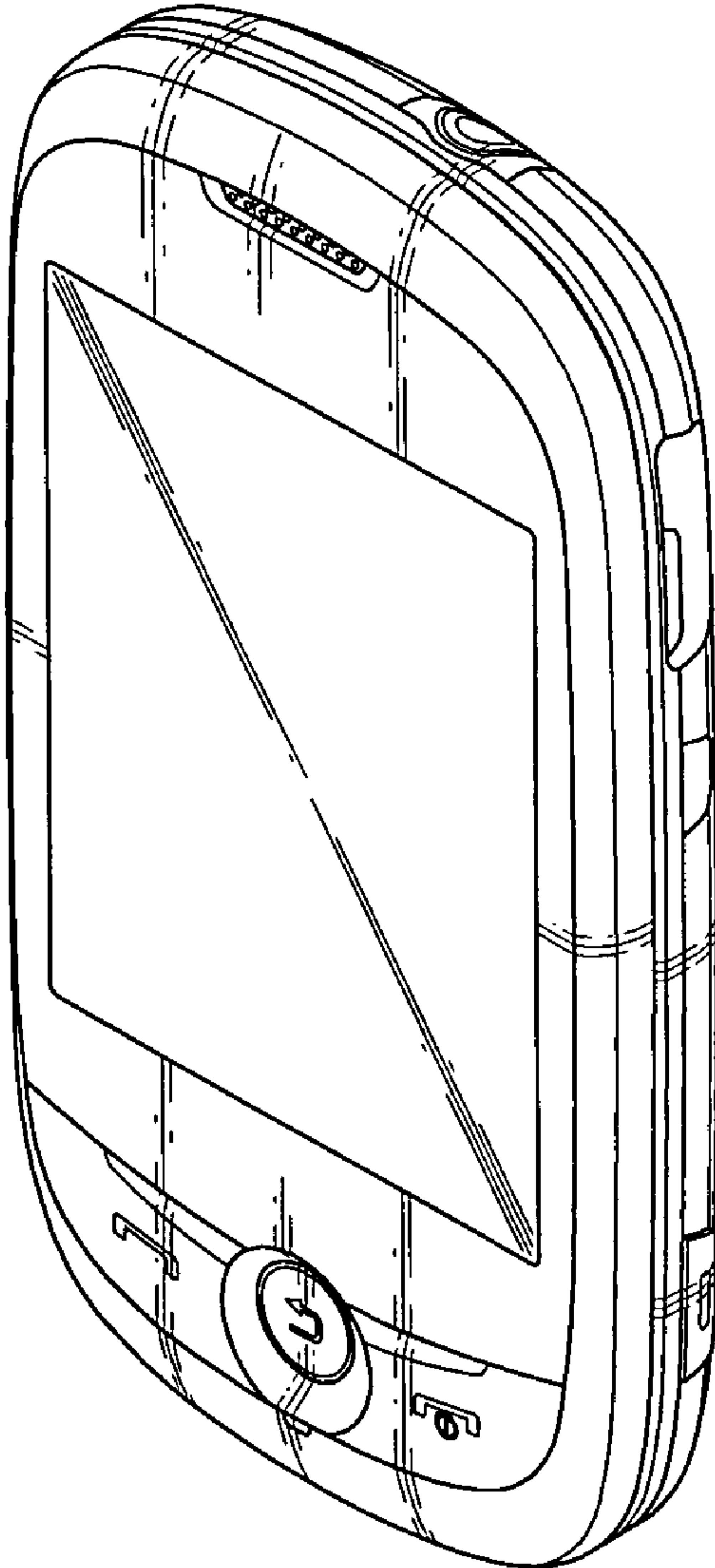

FIG. 2

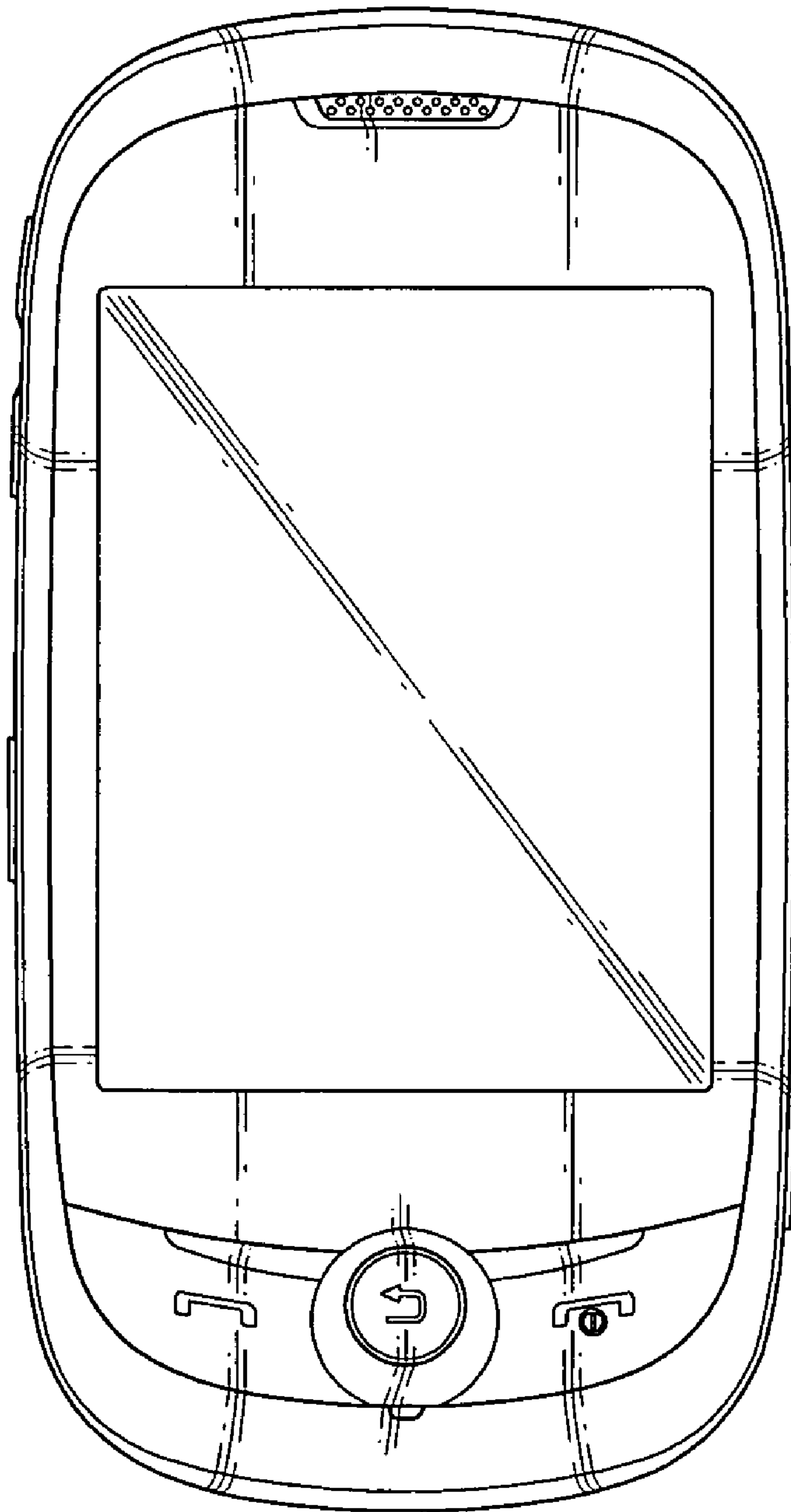

FIG. 3

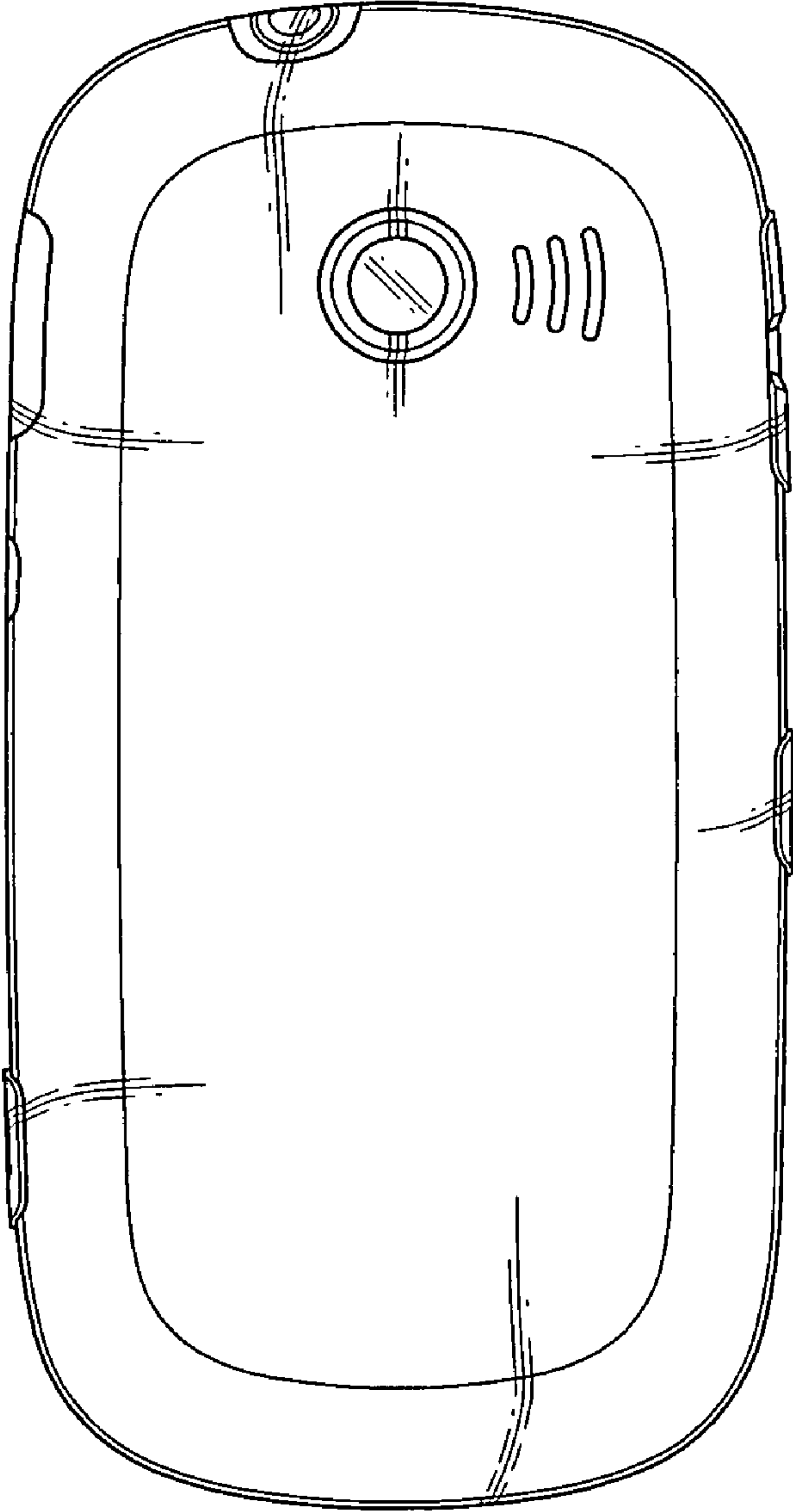

FIG. 4

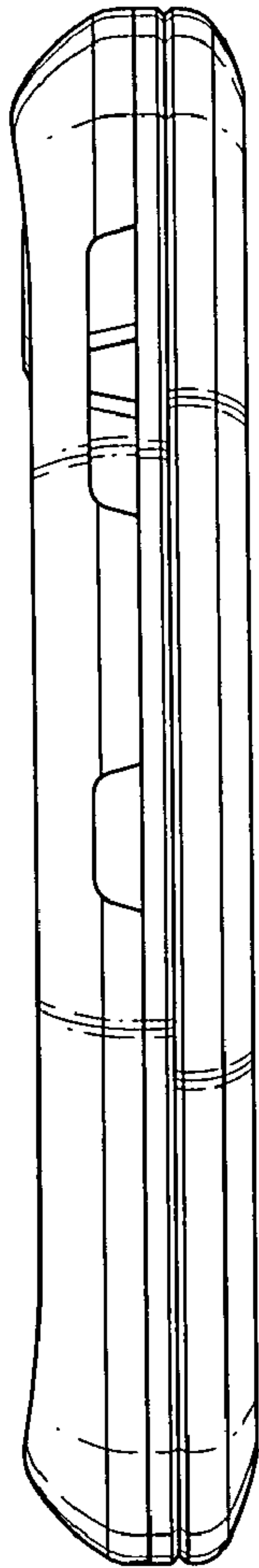

FIG. 5

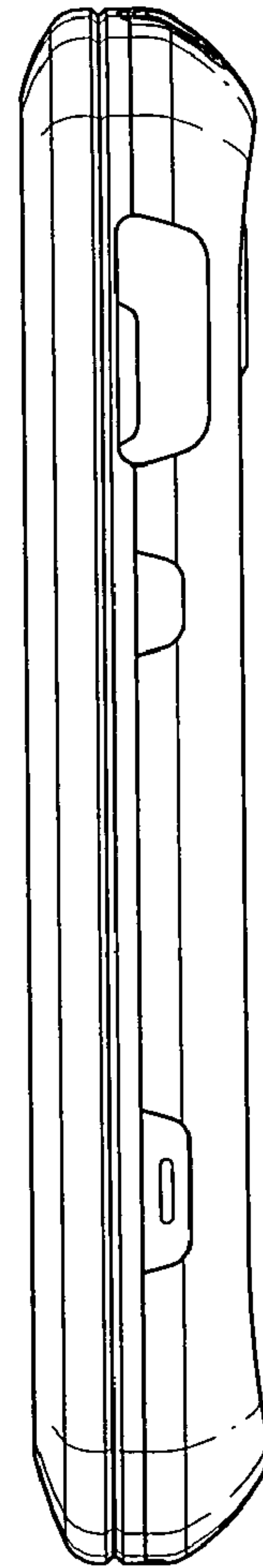

FIG. 6

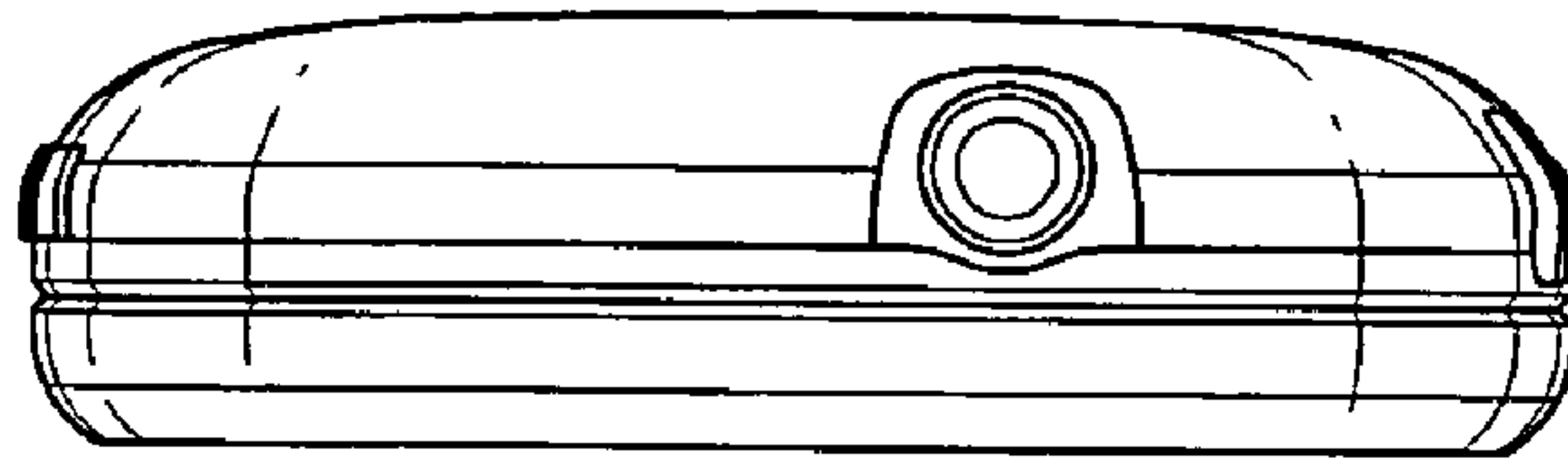

FIG. 7

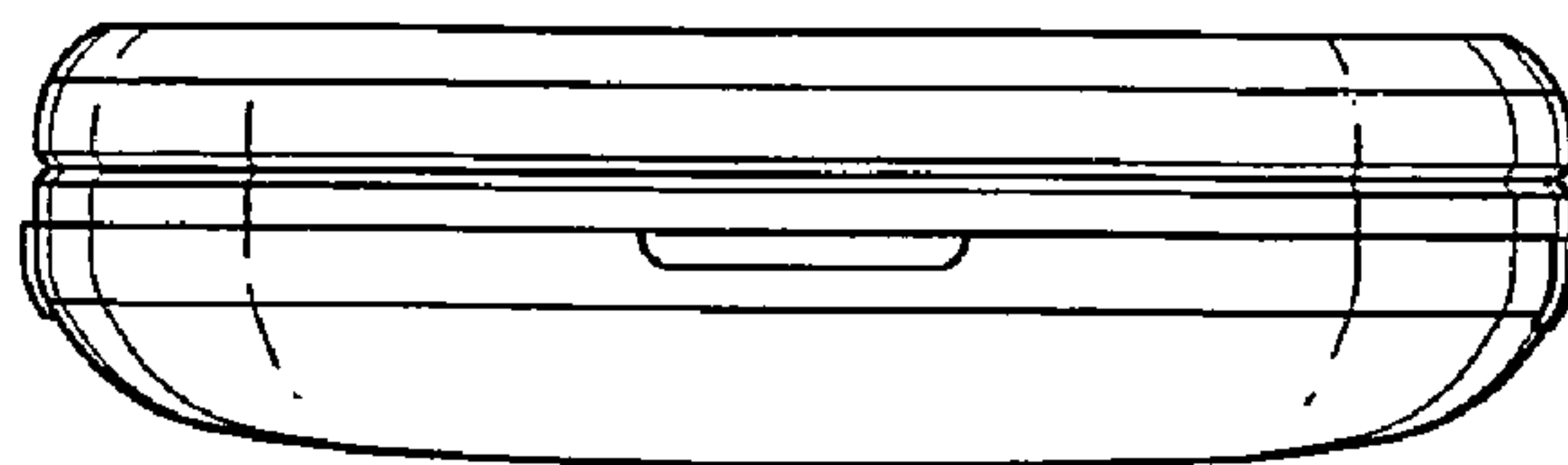

FIG. 8

