



US00D639704S

(12) **United States Design Patent**  
**Harshman**

(10) **Patent No.:** **US D639,704 S**  
(45) **Date of Patent:** **\*\* Jun. 14, 2011**

- (54) **GATHERED SQUARE VASE**
- (75) Inventor: **Trent A. Harshman**, Galveston, IN (US)
- (73) Assignee: **Syndicate Sales, Inc.**, Kokomo, IN (US)
- (\*\*) Term: **14 Years**
- (21) Appl. No.: **29/372,134**
- (22) Filed: **Oct. 20, 2010**
- (51) **LOC (9) Cl.** ..... **11-02**
- (52) **U.S. Cl.** ..... **D11/146; D11/155**
- (58) **Field of Classification Search** ..... D6/403-405,  
D6/556-568; D8/1; D11/143-156, 164;  
D19/77, 80, 81, 84; D25/100; D26/9-11,  
D26/16, 19; D34/1, 2, 4-6; D99/5, 19; 47/17,  
47/32.4, 32.5, 32.7, 33, 39, 41.01, 41.1, 41.11-41.15,  
47/44-47, 63, 65.5, 65.9, 66.1, 66.2, 66.6,  
47/66.7, 67-71  
See application file for complete search history.

(56) **References Cited**

U.S. PATENT DOCUMENTS

D244,501 S *	5/1977	Jacobus	.....	D11/155
D282,152 S *	1/1986	Mendenhall	.....	D11/154
D302,406 S *	7/1989	Weder	.....	D11/155
D446,748 S	8/2001	Hutton		
D448,097 S *	9/2001	Bodum	.....	D26/9
D459,166 S *	6/2002	Harrison, Jr.	.....	D8/1
D462,293 S	9/2002	Bates et al.		
D462,294 S	9/2002	Walsh		
D462,295 S	9/2002	Bates et al.		
D462,296 S	9/2002	Bates et al.		
D463,615 S *	9/2002	Habibi et al.	.....	D11/154
D478,531 S	8/2003	Abbud et al.		
D582,534 S	12/2008	Conway et al.		

D612,289 S *	3/2010	Donovan	.....	D11/146
D612,290 S *	3/2010	Donovan	.....	D11/155
D621,740 S *	8/2010	Garcia et al.	.....	D11/154

\* cited by examiner

*Primary Examiner* — Garth Rademaker

(74) *Attorney, Agent, or Firm* — Frank D Lachenmaier

(57) **CLAIM**

The ornamental design for a gathered square vase, as shown and described.

**DESCRIPTION**

FIG. 1 is a top view of a vase showing my new design;  
 FIG. 2 is a front view thereof where the back view is a mirror image of the front view;  
 FIG. 3 is a left side view thereof, where the right side view is a mirror image of left side view;  
 FIG. 4 is a top view of a second embodiment of a vase showing my new design;  
 FIG. 5 is a front view thereof where the back view is a mirror image of the front view;  
 FIG. 6 is a left side view thereof, where the right side view is a mirror image of left side view;  
 FIG. 7 is a top view of a third embodiment of a vase showing my new design;  
 FIG. 8 is a front view thereof where the back view is a mirror image of the front view;  
 FIG. 9 is a left side view thereof, where the right side view is a mirror image of left side view;  
 FIG. 10 is a top view of a fourth embodiment of a vase showing my new design;  
 FIG. 11 is a front view thereof, where the back view is a mirror image of the front view; and,  
 FIG. 12 is a left side view thereof, where the right side view is a mirror image of the left side view.

**1 Claim, 4 Drawing Sheets**

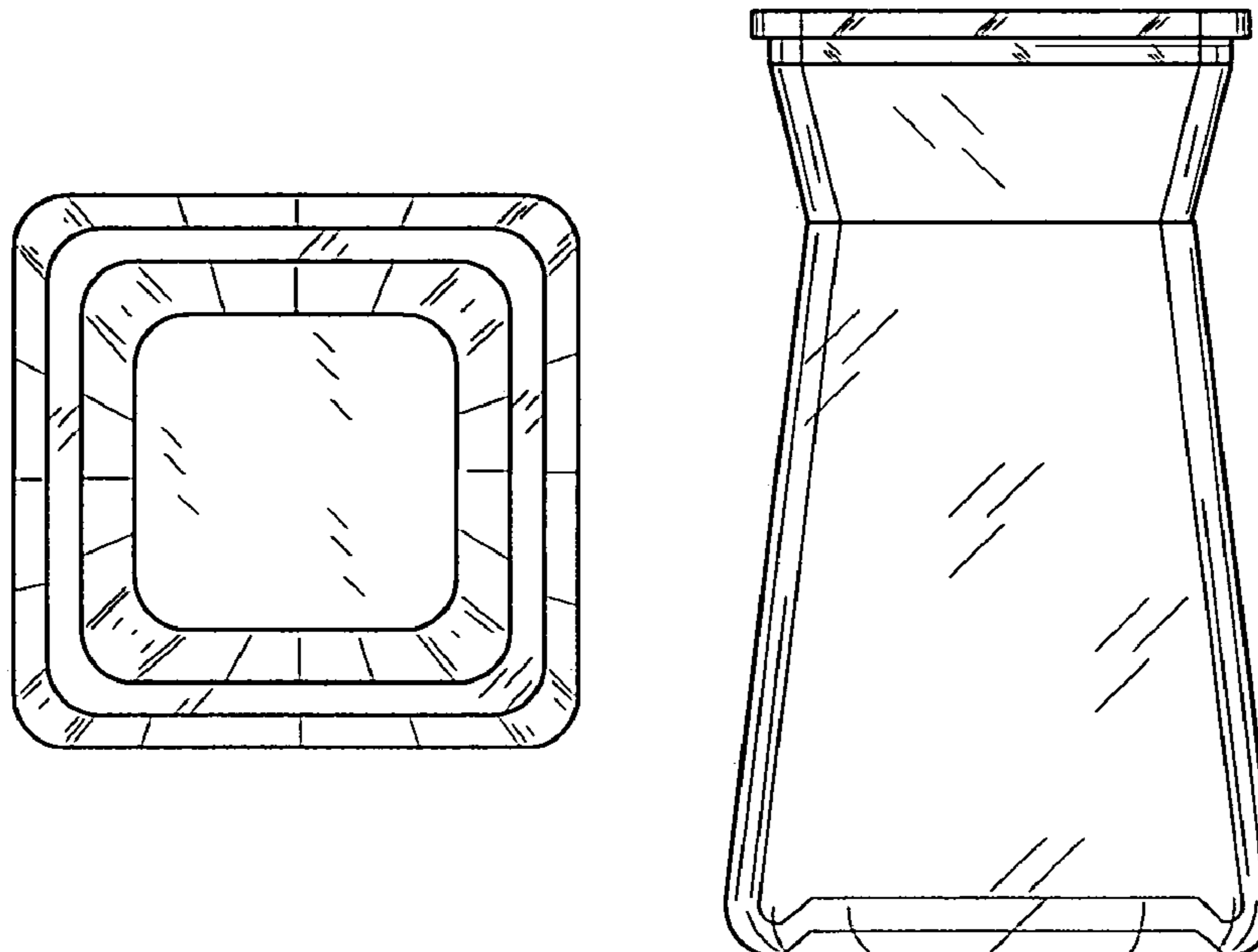

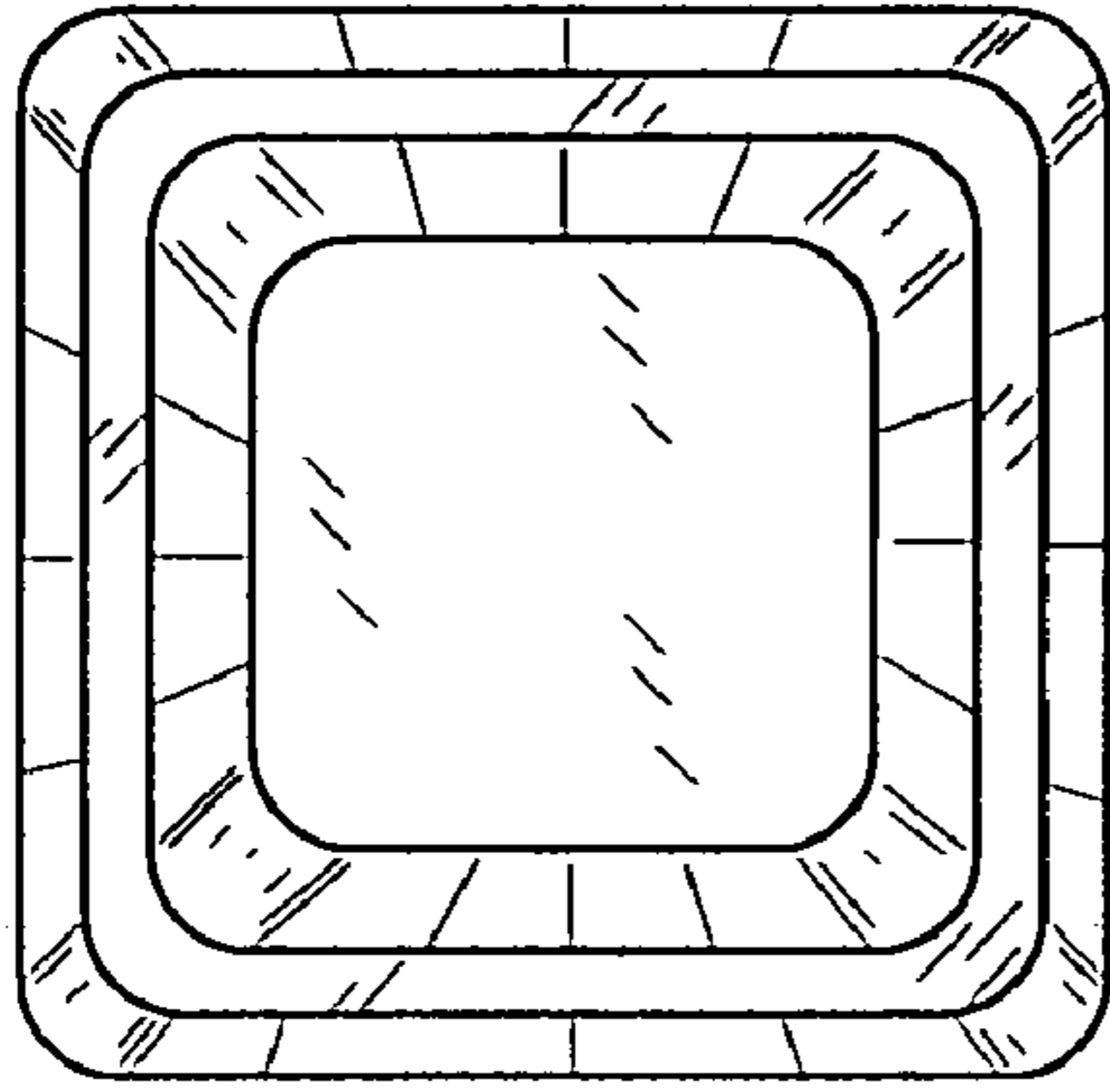

FIG. 1

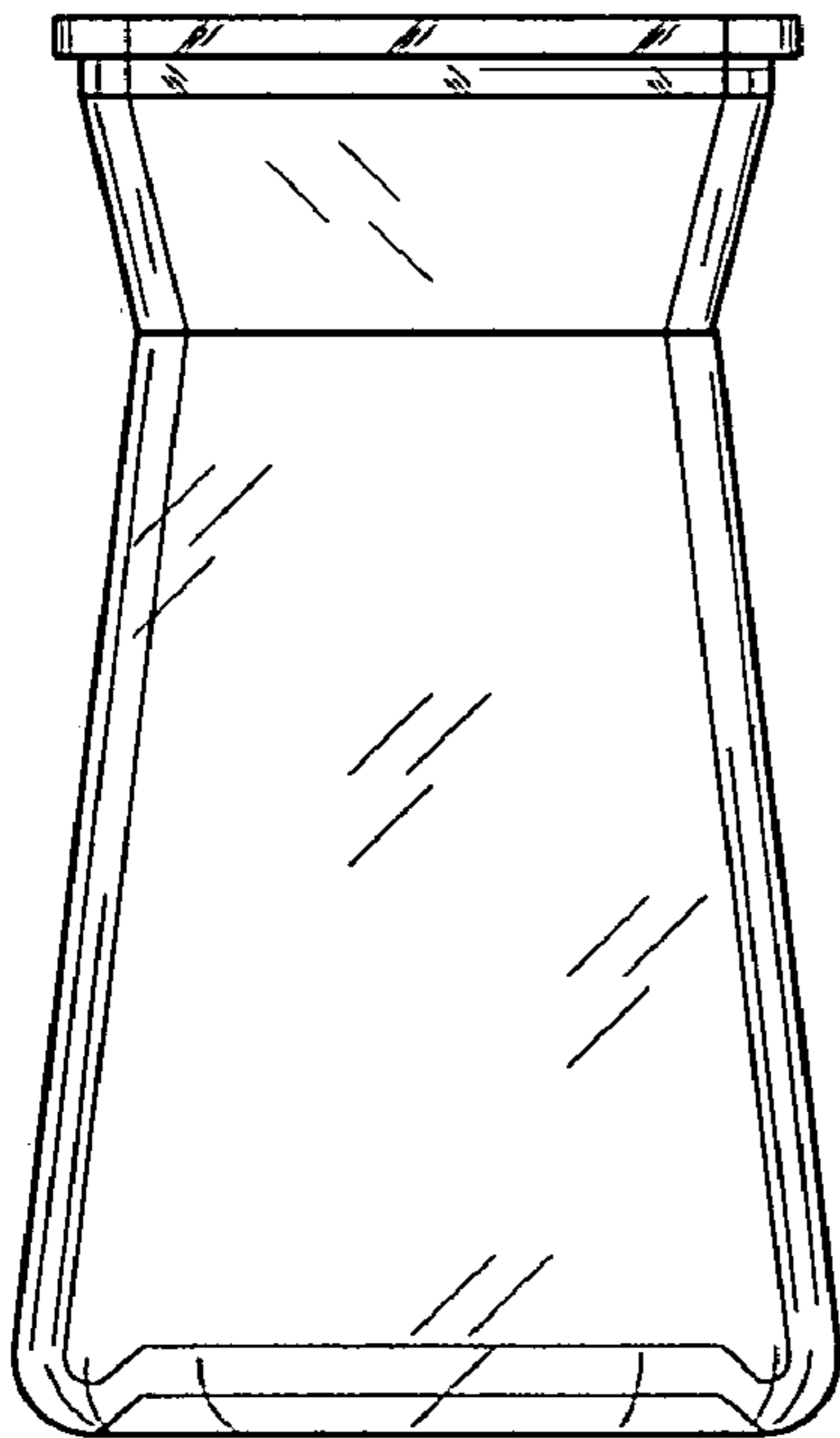

FIG. 2

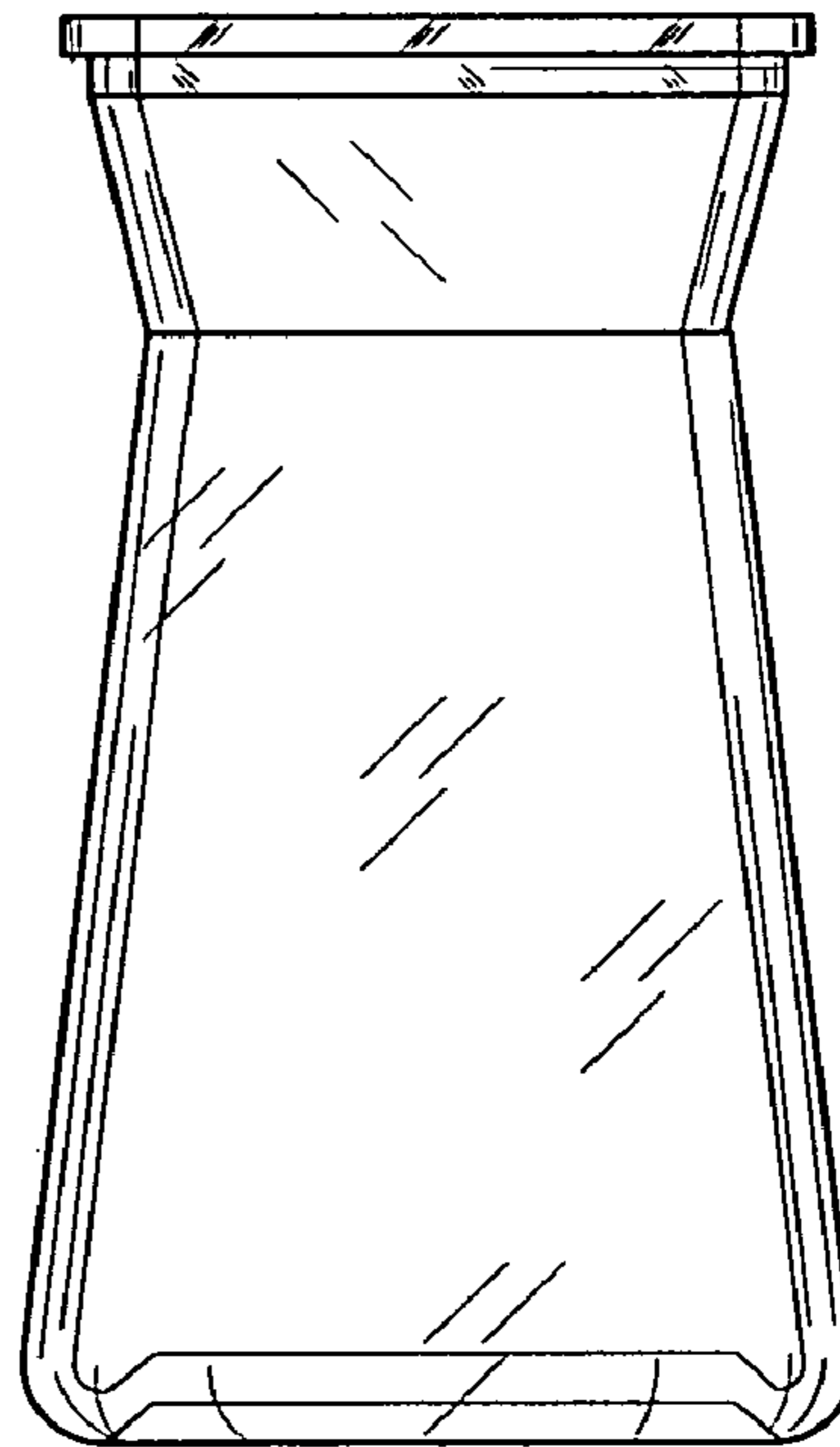

FIG. 3

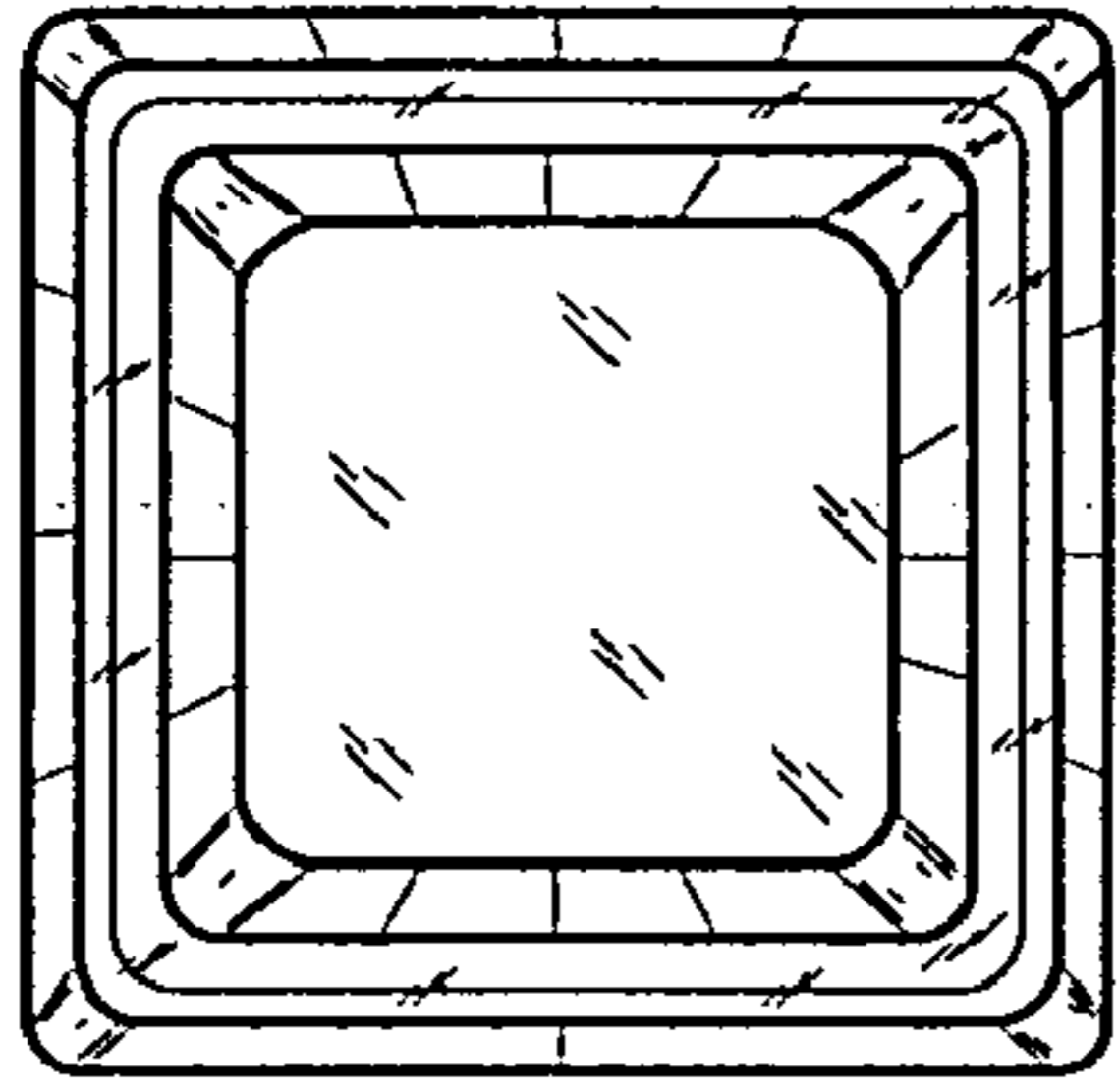

FIG. 4

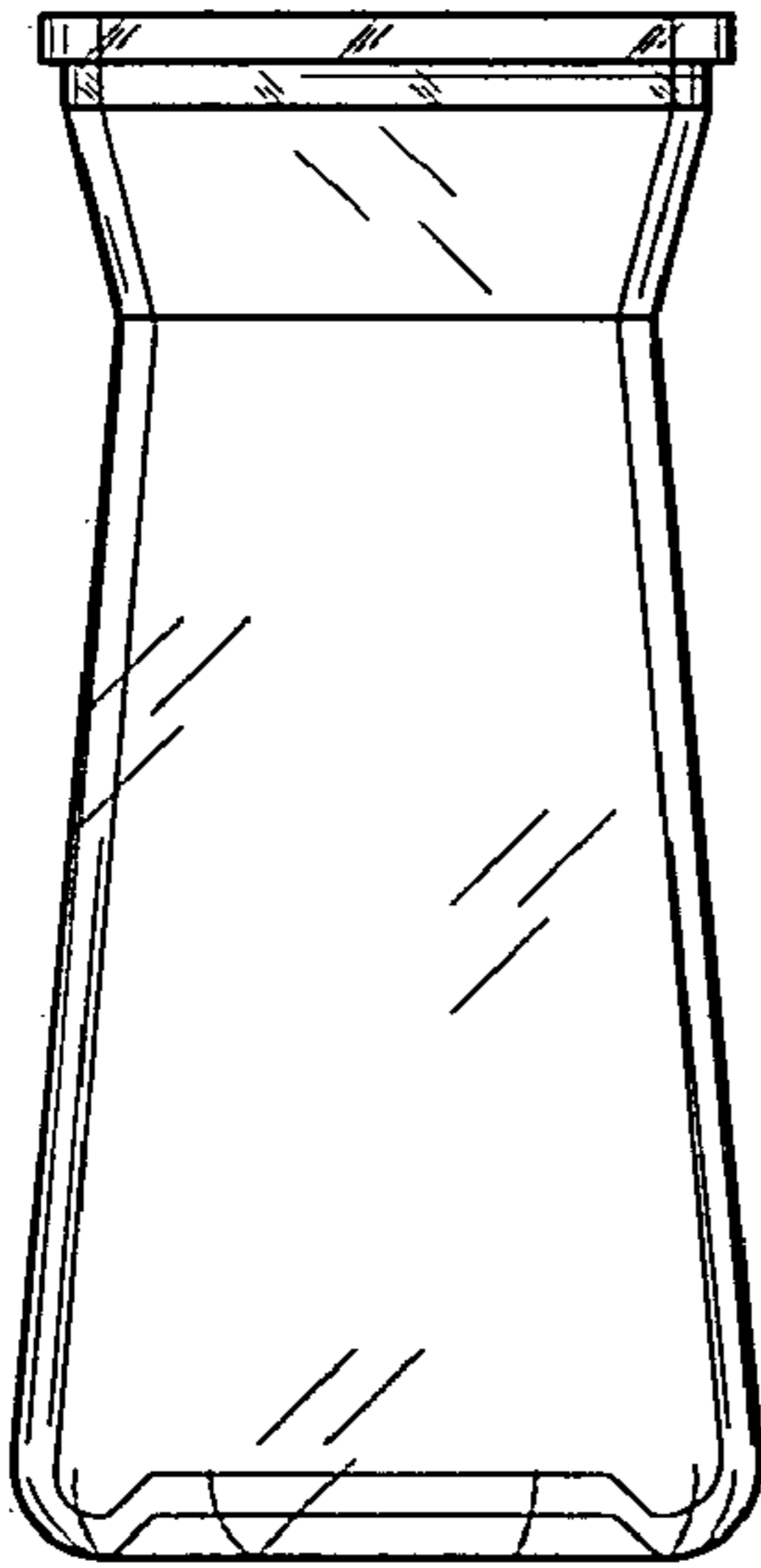

FIG. 5

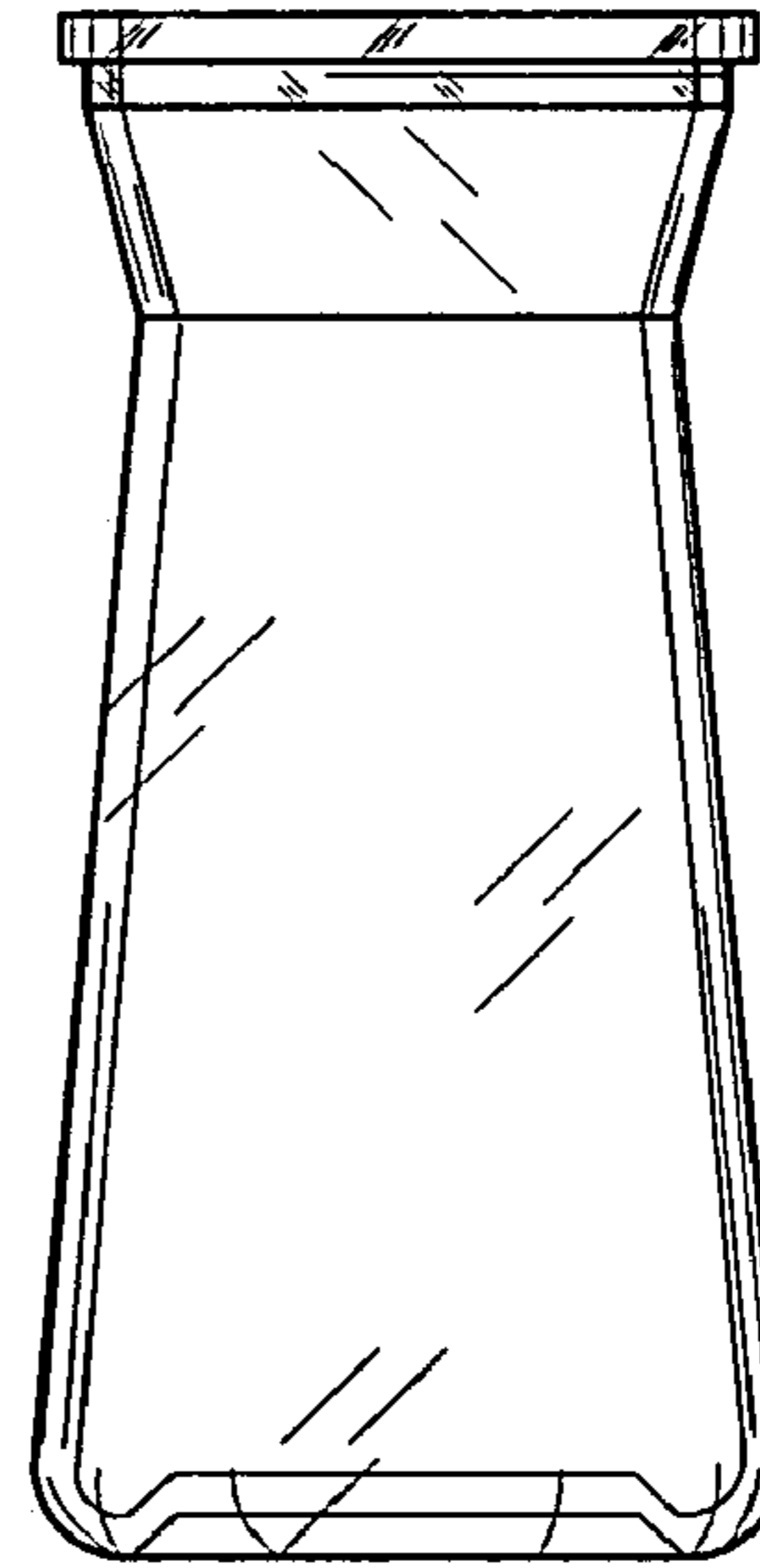

FIG. 6

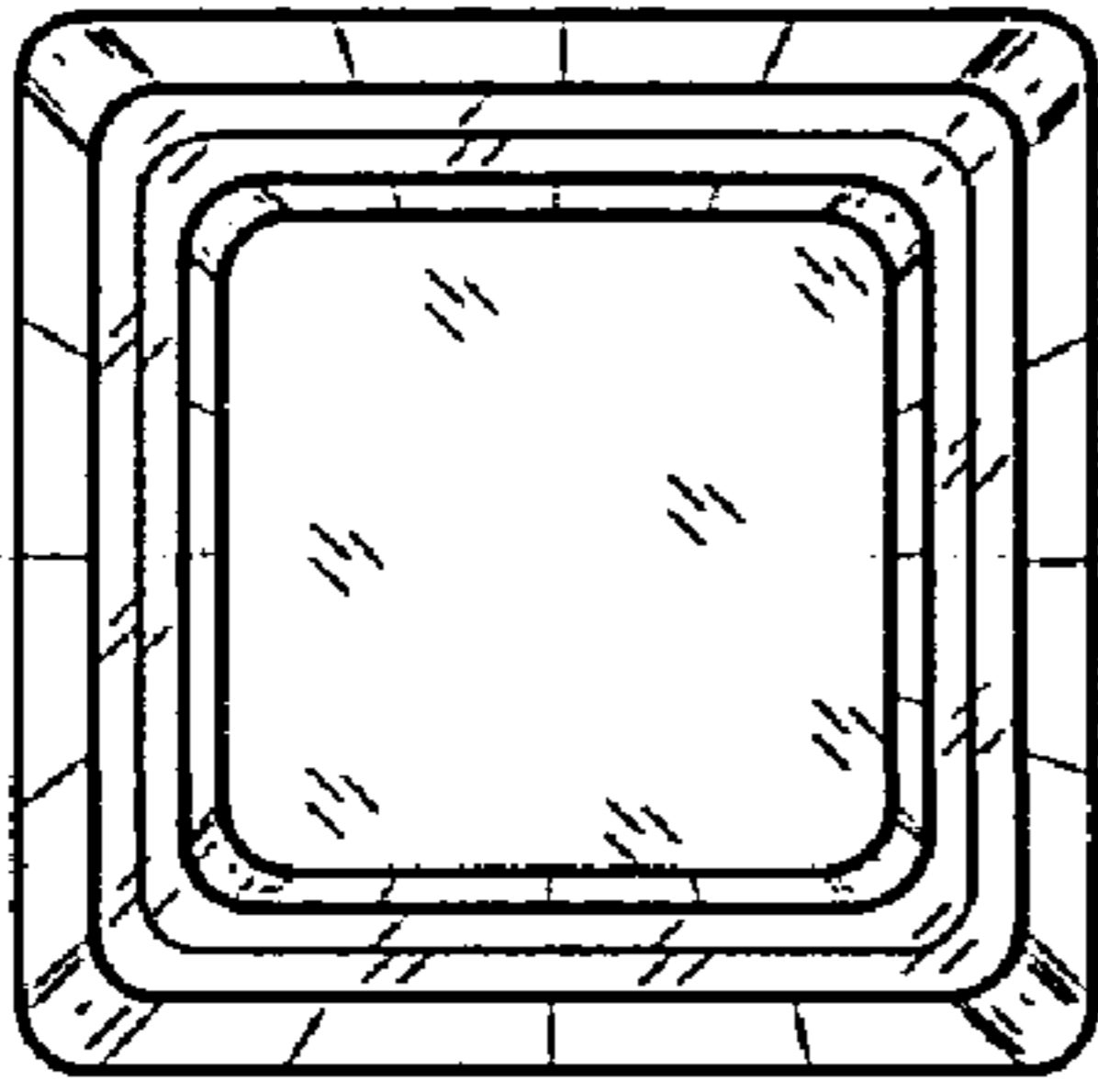

FIG. 7

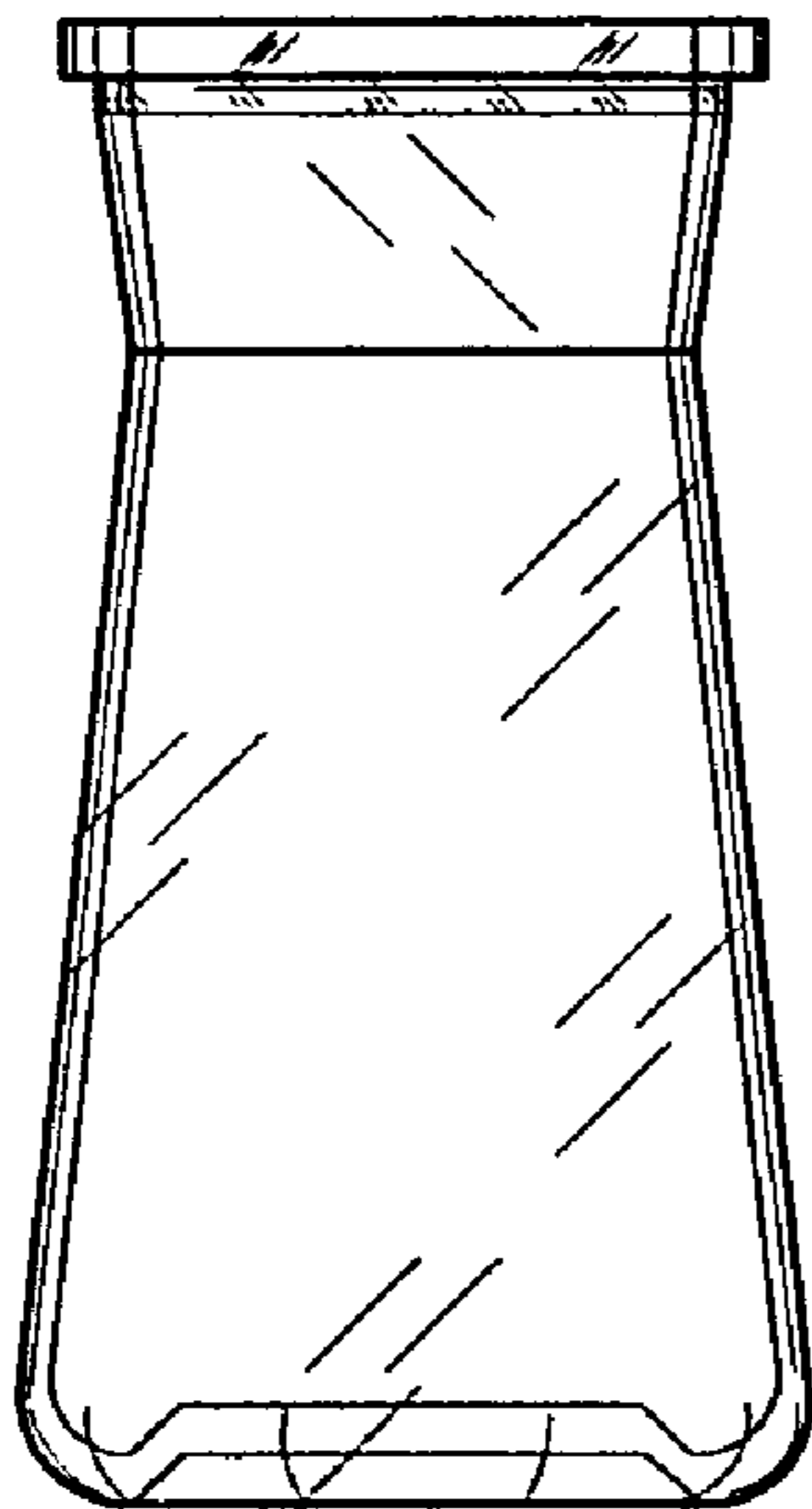

FIG. 8

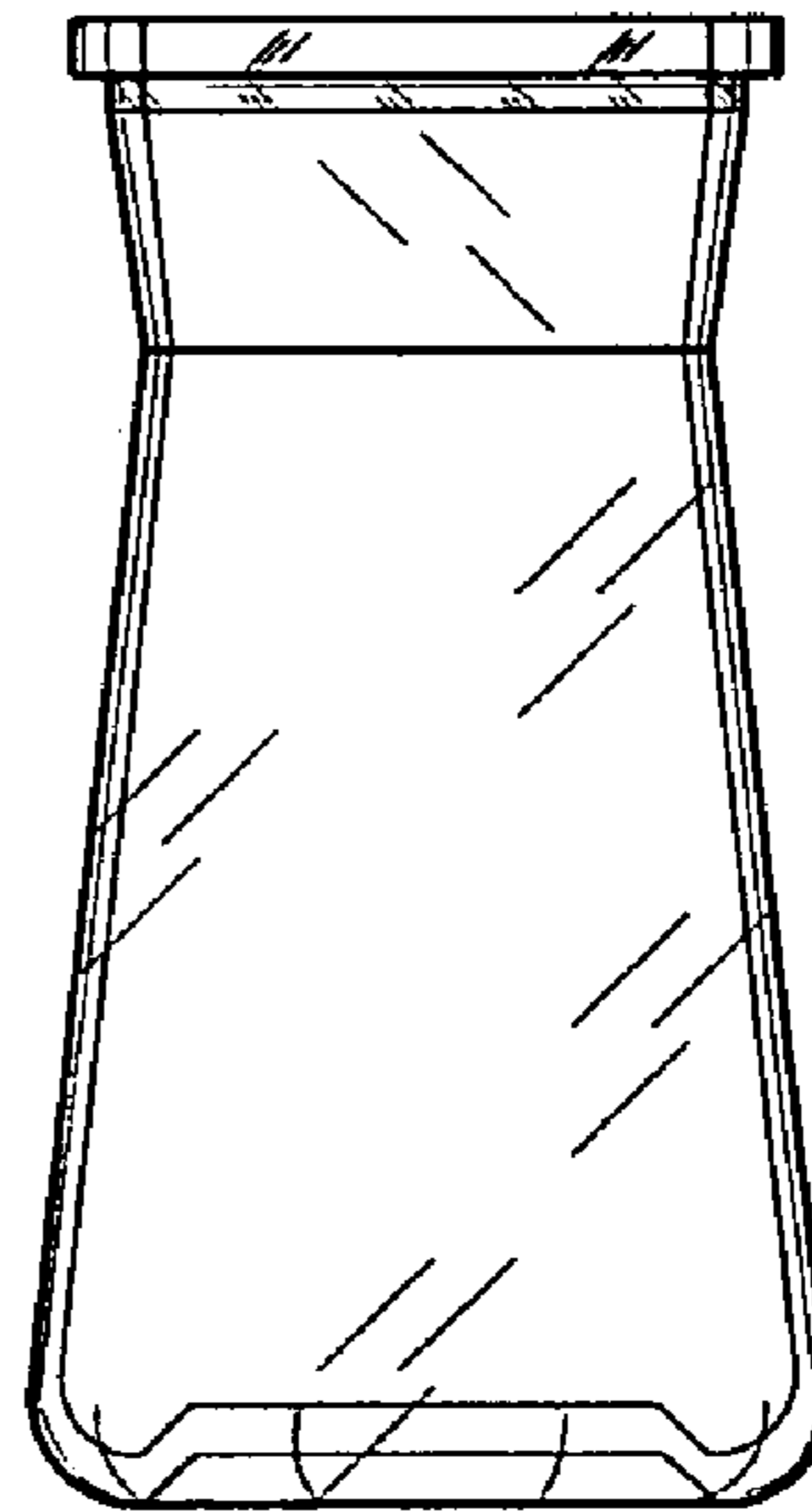

FIG. 9

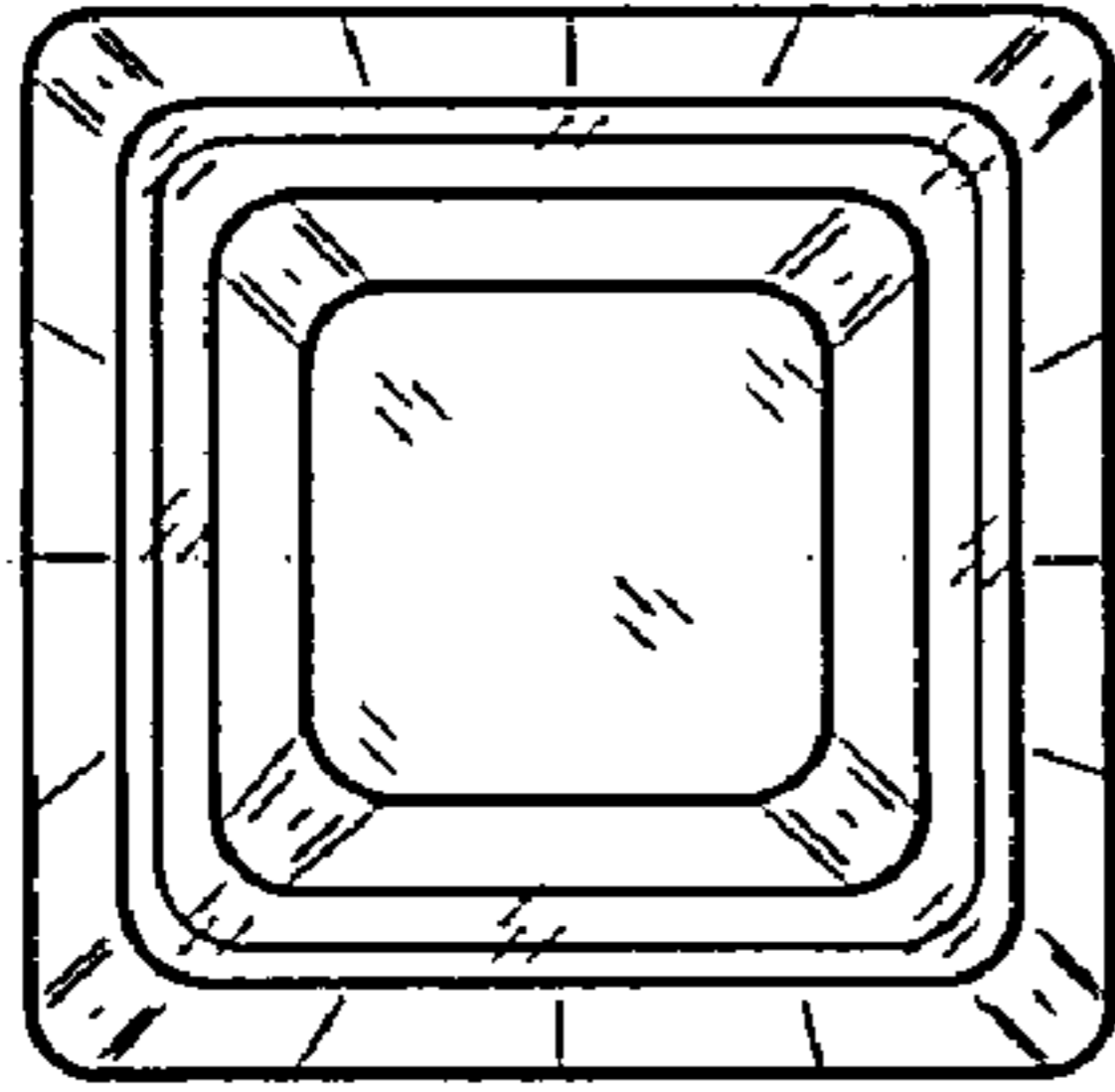

FIG. 10

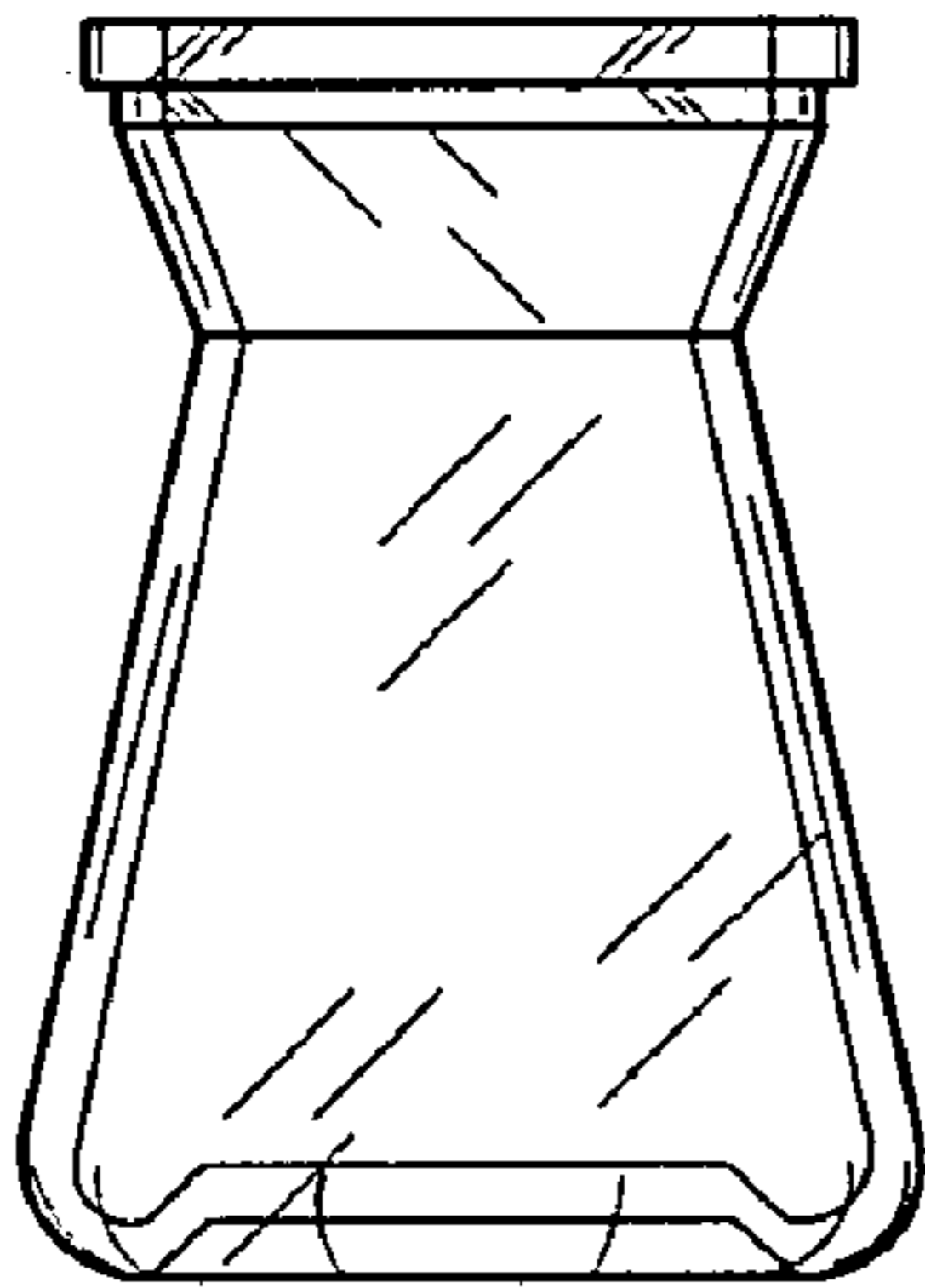

FIG. 11

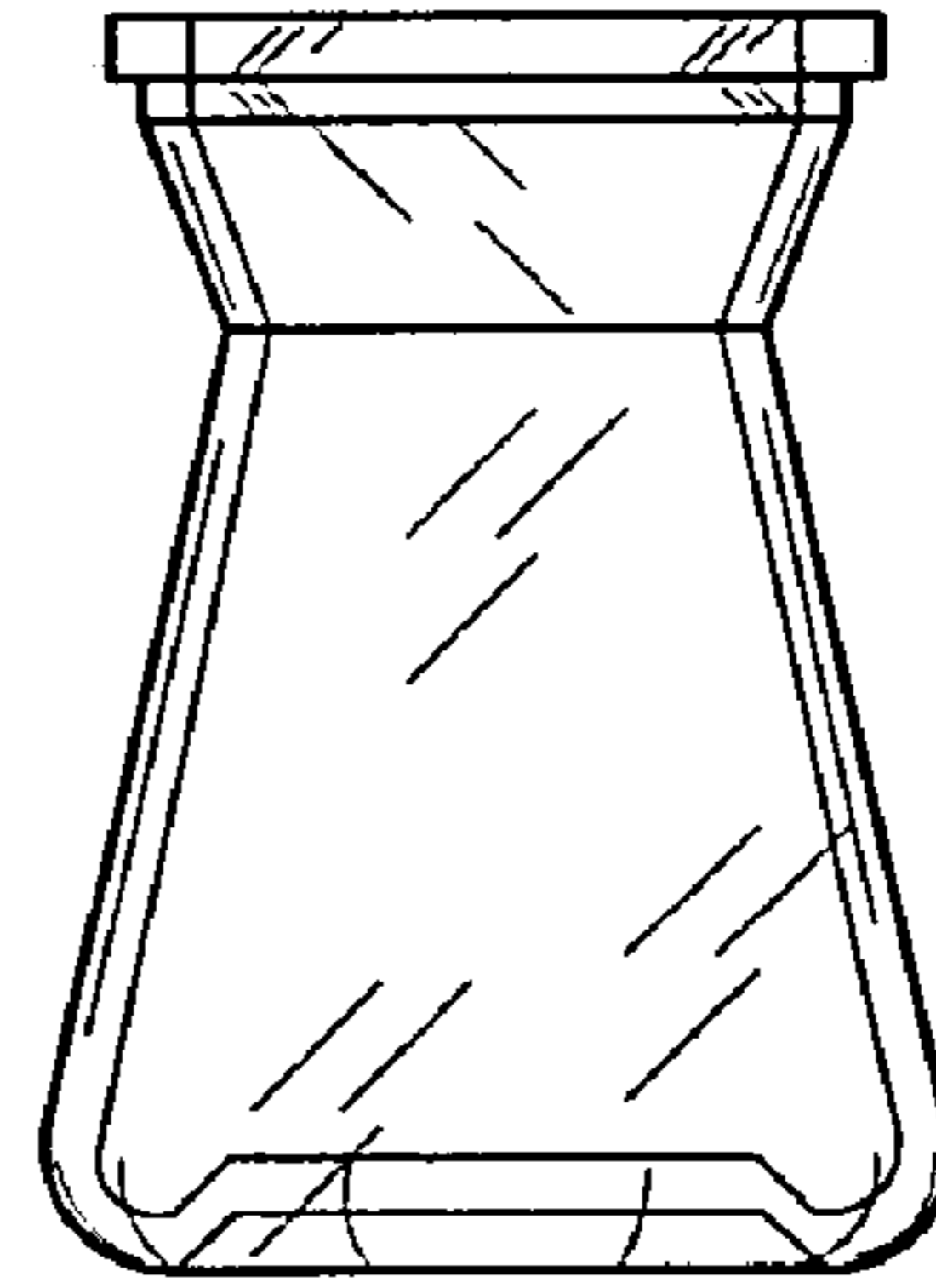

FIG. 12