



US00D639582S

(12) **United States Design Patent**  
**Mischkulnig**

(10) **Patent No.:** **US D639,582 S**

(45) **Date of Patent:** **\*\* Jun. 14, 2011**

(54) **DISPLAY STAND**

(75) Inventor: **Lars-Bjorn Mischkulnig**, Biel/Bienne (CH)

(73) Assignee: **Swatch AG (Swatch SA) (Swatch Ltd.)**, Biel/Bienne (CH)

(\*\*) Term: **14 Years**

(21) Appl. No.: **29/320,937**

(22) Filed: **Jul. 8, 2008**

(30) **Foreign Application Priority Data**

Jan. 8, 2008 (WO) ..... DM/069 638

(51) **LOC (9) Cl.** ..... **06-01**

(52) **U.S. Cl.** ..... **D6/474**

(58) **Field of Classification Search** ..... D6/474,  
D6/473, 449, 468, 455, 457, 464, 465-467;  
108/100, 92, 59, 91, 235.1, 235.2, 235.5,  
108/249.8, 278, 281; 211/13, 36-38, 128,  
211/135, 163, 186, 85.2; 312/114, 117, 126,  
312/258; 482/52, 35

See application file for complete search history.

(56) **References Cited**

**U.S. PATENT DOCUMENTS**

D28,415 S \* 3/1898 Warren ..... D6/473  
821,391 A \* 5/1906 Wiltse ..... 482/35

1,931,521 A \* 10/1933 Ziemmerman ..... 108/100  
D114,306 S \* 4/1939 Hokstad ..... D6/449  
D207,564 S \* 5/1967 Hartford ..... D6/468  
4,025,137 A \* 5/1977 Wyler ..... 312/114  
D286,835 S \* 11/1986 Marsh ..... D6/474  
5,357,876 A \* 10/1994 Kniefel et al. .... 108/92  
5,480,225 A \* 1/1996 Bailey ..... 312/258  
D381,840 S \* 8/1997 Bevill et al. .... D6/474  
5,692,445 A \* 12/1997 Winer ..... 108/100  
D507,431 S \* 7/2005 Goth ..... D6/474  
D524,577 S \* 7/2006 Gusdorf et al. .... D6/474  
2004/0060879 A1 \* 4/2004 Cohen ..... 211/85.2

\* cited by examiner

*Primary Examiner* — Philip S Hyder

*Assistant Examiner* — Sydney R Buffalow

(74) *Attorney, Agent, or Firm* — Collen IP; Donald J. Ranft

(57) **CLAIM**

The ornamental design for a display stand, as shown and described.

**DESCRIPTION**

FIG. 1 is a right side view of my new, original and ornamental design for a display stand;  
FIG. 2 is a left side view thereof;  
FIG. 3 is front view thereof;  
FIG. 4 is a rear view thereof;  
FIG. 5 is a top view thereof;  
FIG. 6 is a bottom view thereof;  
FIG. 7 is a right rear perspective view thereof; and,  
FIG. 8 is a right front perspective view thereof.

**1 Claim, 1 Drawing Sheet**

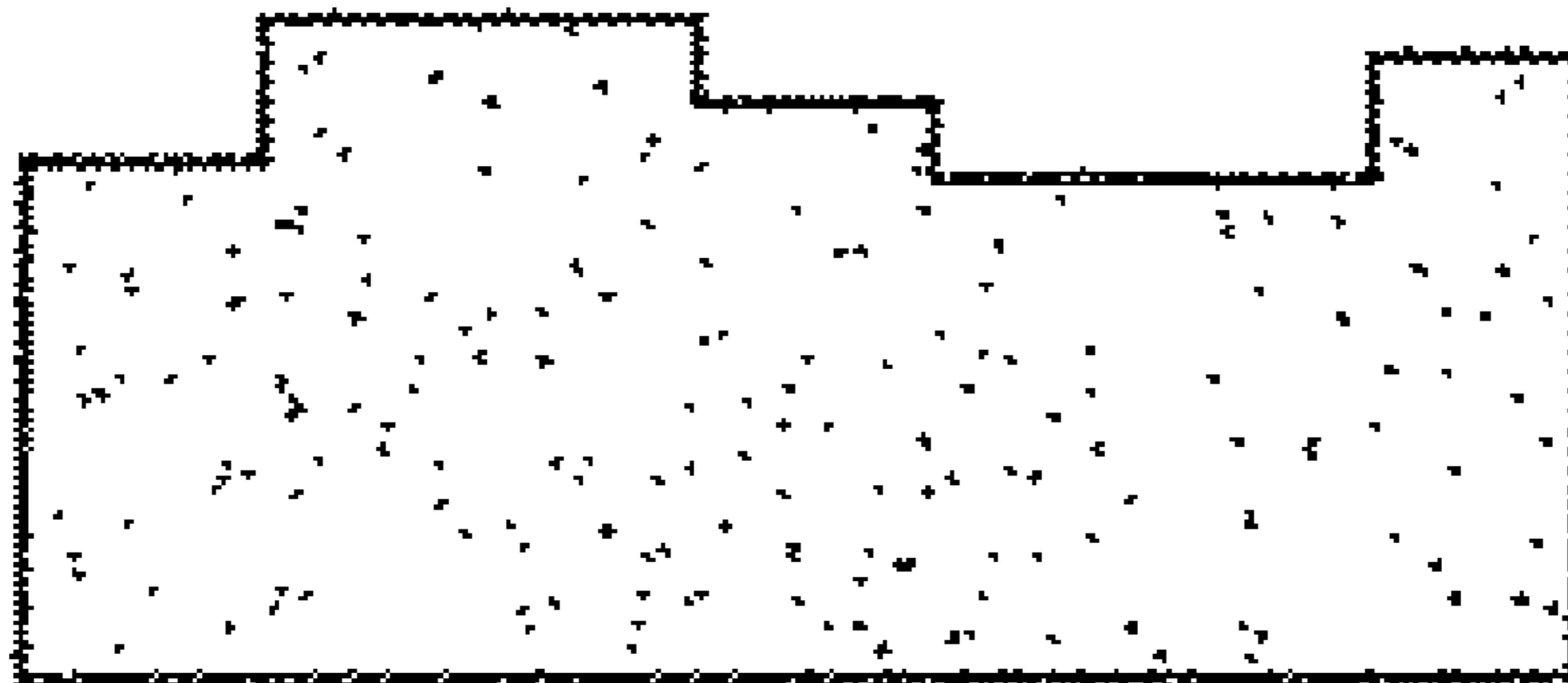

FIG. 1



FIG. 2

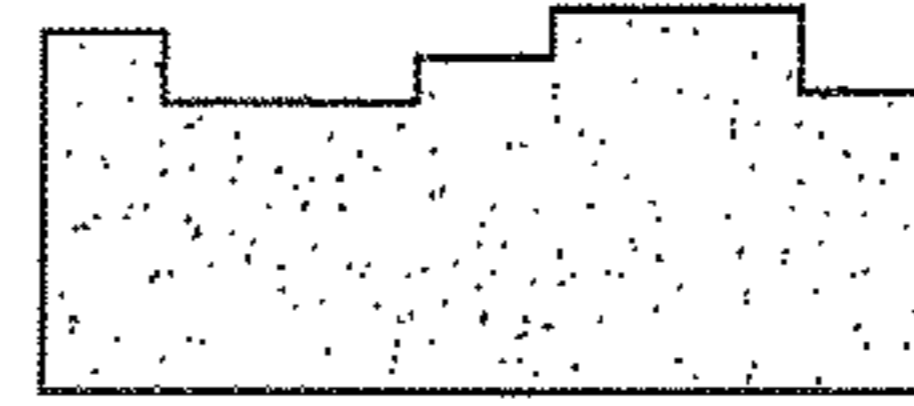

FIG. 3

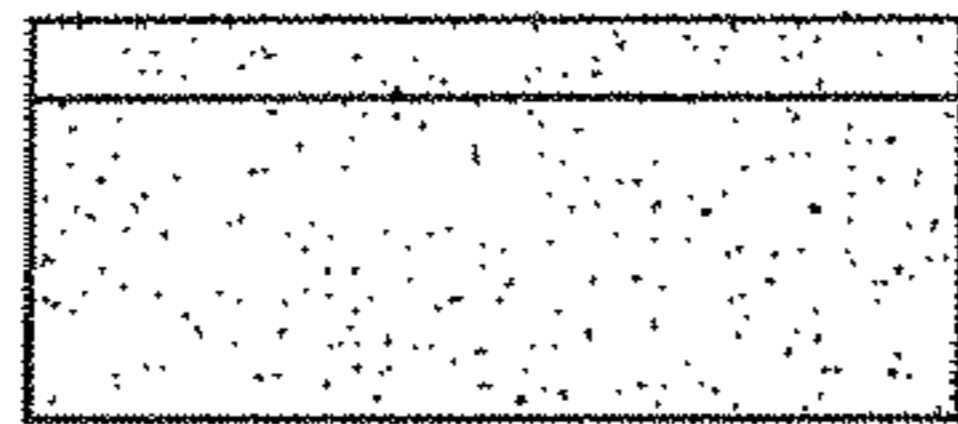

FIG. 4

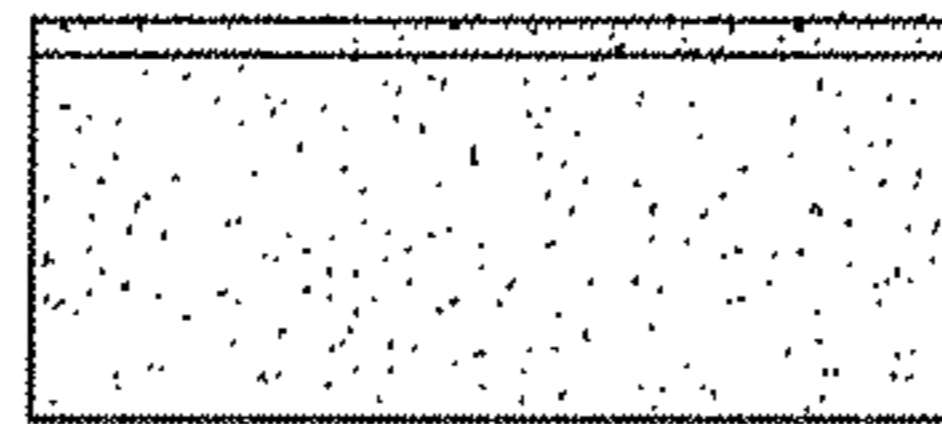

FIG. 5

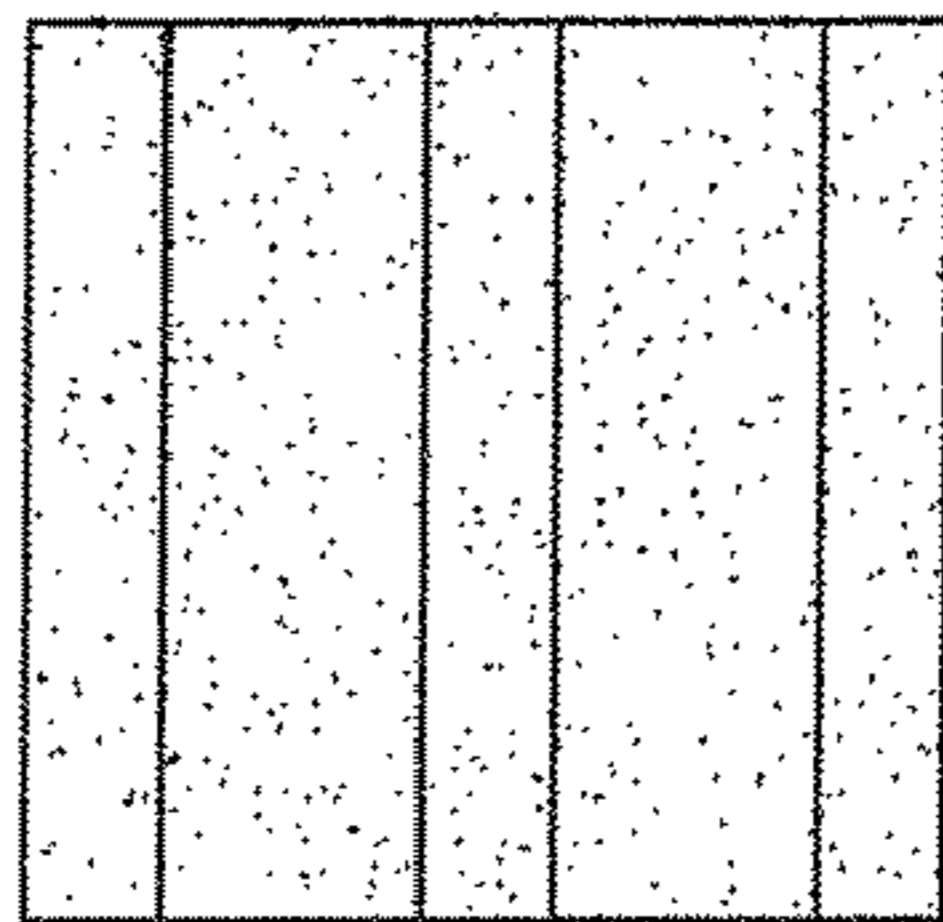

FIG. 6

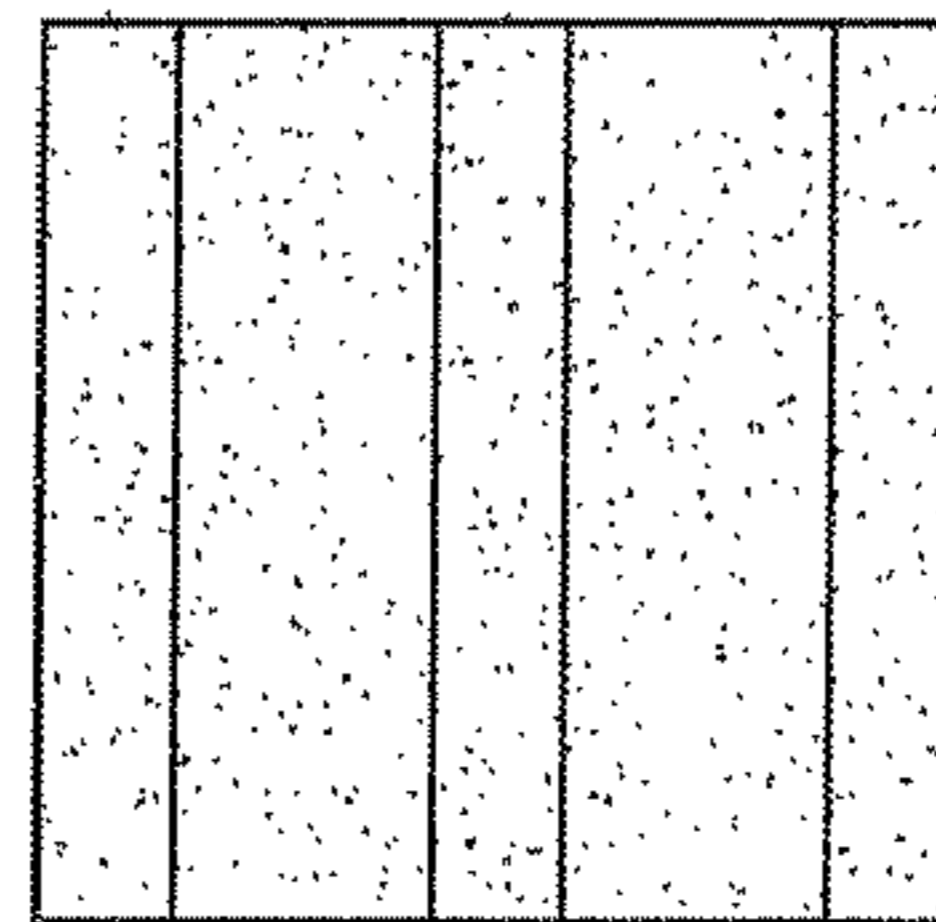

FIG. 7

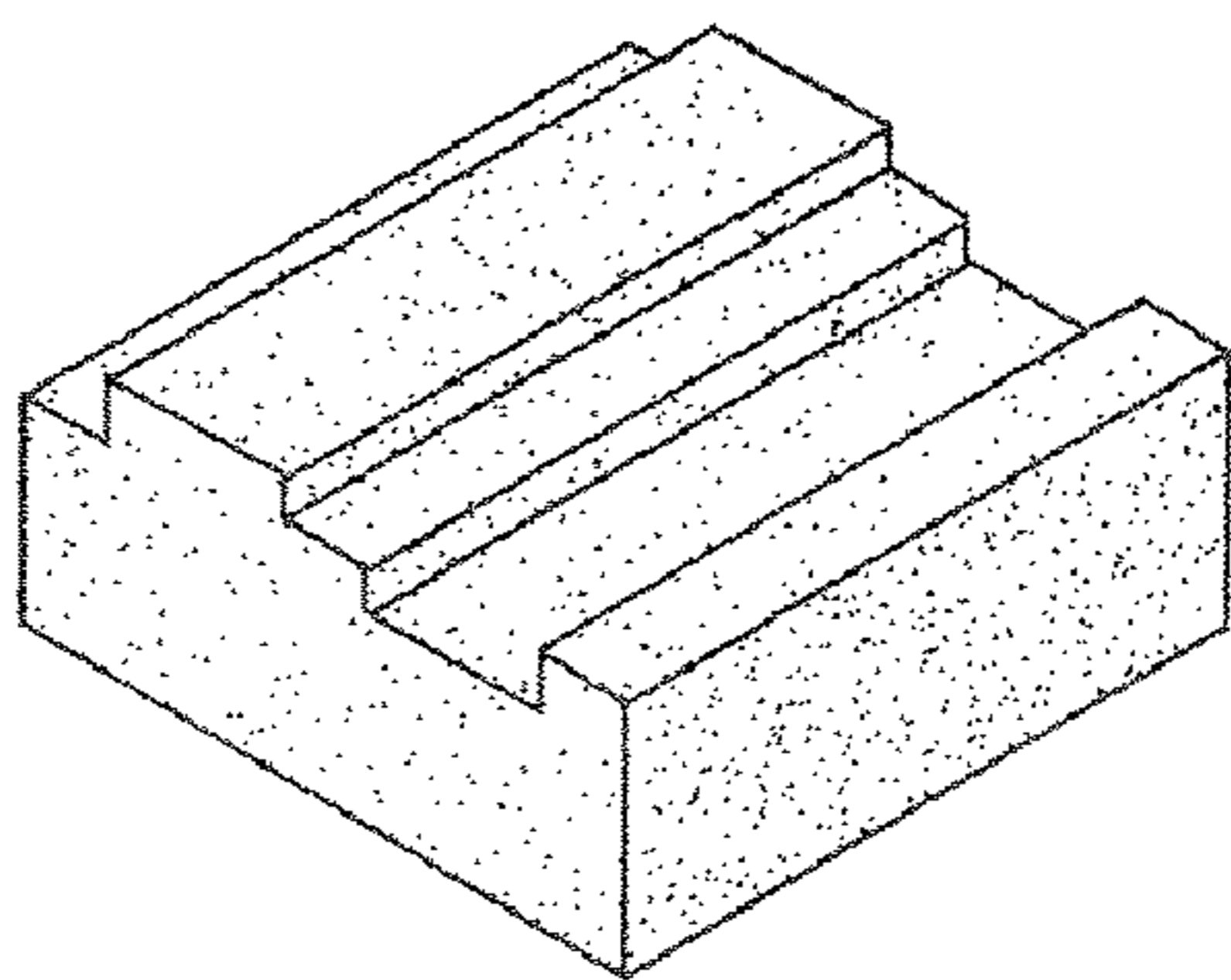

FIG. 8

