

US00D639574S

(12) **United States Design Patent**  
**Nusret**

(10) **Patent No.:** **US D639,574 S**  
(45) **Date of Patent:** **\*\* Jun. 14, 2011**

(54) **MOTORCYCLE BACKREST**

(76) Inventor: **Michael Nusret**, South Elgin, IL (US)

(\*\*) Term: **14 Years**

(21) Appl. No.: **29/362,170**

(22) Filed: **May 20, 2010**

**Related U.S. Application Data**

(63) Continuation-in-part of application No. 29/356,873, filed on Mar. 3, 2010.

(51) **LOC (9) Cl.** ..... **06-01**

(52) **U.S. Cl.** ..... **D6/354**

(58) **Field of Classification Search** ..... D6/354, D6/502, 611, 343, 367, 368, 374, 356; D12/222, D12/119, 110, 114; 297/215.1-215.16, 243, 297/452.48, 230.1, 181, 452.65, 195.1, 196-215, 297/45, 218.1-218.5, 219.1, 219.11, 228.1, 297/228.12, 230.14, 452.63, 452.59; 296/65.01, 296/68.01, 65.16; D26/32, 34, 35; 362/473, 362/540, 545, 548, 549; 180/219

See application file for complete search history.

(56) **References Cited**

**U.S. PATENT DOCUMENTS**

D242,032 S \* 10/1976 Hartlaub ..... D12/119  
D245,078 S \* 7/1977 Greene ..... D12/119  
D287,553 S \* 1/1987 Rossi ..... D6/368  
RE33,178 E \* 3/1990 Ahlberg ..... 280/801.2

D317,428 S \* 6/1991 Carr ..... D12/222  
D332,540 S \* 1/1993 Peterson ..... D6/502  
6,053,626 A \* 4/2000 Zagrodnik et al. .... 362/473  
D528,311 S \* 9/2006 Stahel et al. .... D6/354

**OTHER PUBLICATIONS**

Mar. 2, 2009 posting of sissy bars from Sissy Bar School (6 pages). [Retrieved on Apr. 2, 2010]. Retrieved from the Internet <URL: <http://www.knucklebusterinc.com/features/2009/03/02/sissy-bar-school/>>.\*

\* cited by examiner

*Primary Examiner* — Philip S Hyder

*Assistant Examiner* — Linda G. Brooks

(74) *Attorney, Agent, or Firm* — Sinorica, LLC

(57) **CLAIM**

The ornamental design for a motorcycle backrest, as shown and described.

**DESCRIPTION**

FIG. 1 is a front perspective view of a motorcycle backrest; FIG. 2 is a front elevational view thereof; FIG. 3 is a rear elevational view thereof; FIG. 4 is a left-side elevational view thereof; FIG. 5 is a right-side elevational view thereof; FIG. 6 is a top plan view thereof; and, FIG. 7 is a bottom plan view thereof.

**1 Claim, 4 Drawing Sheets**

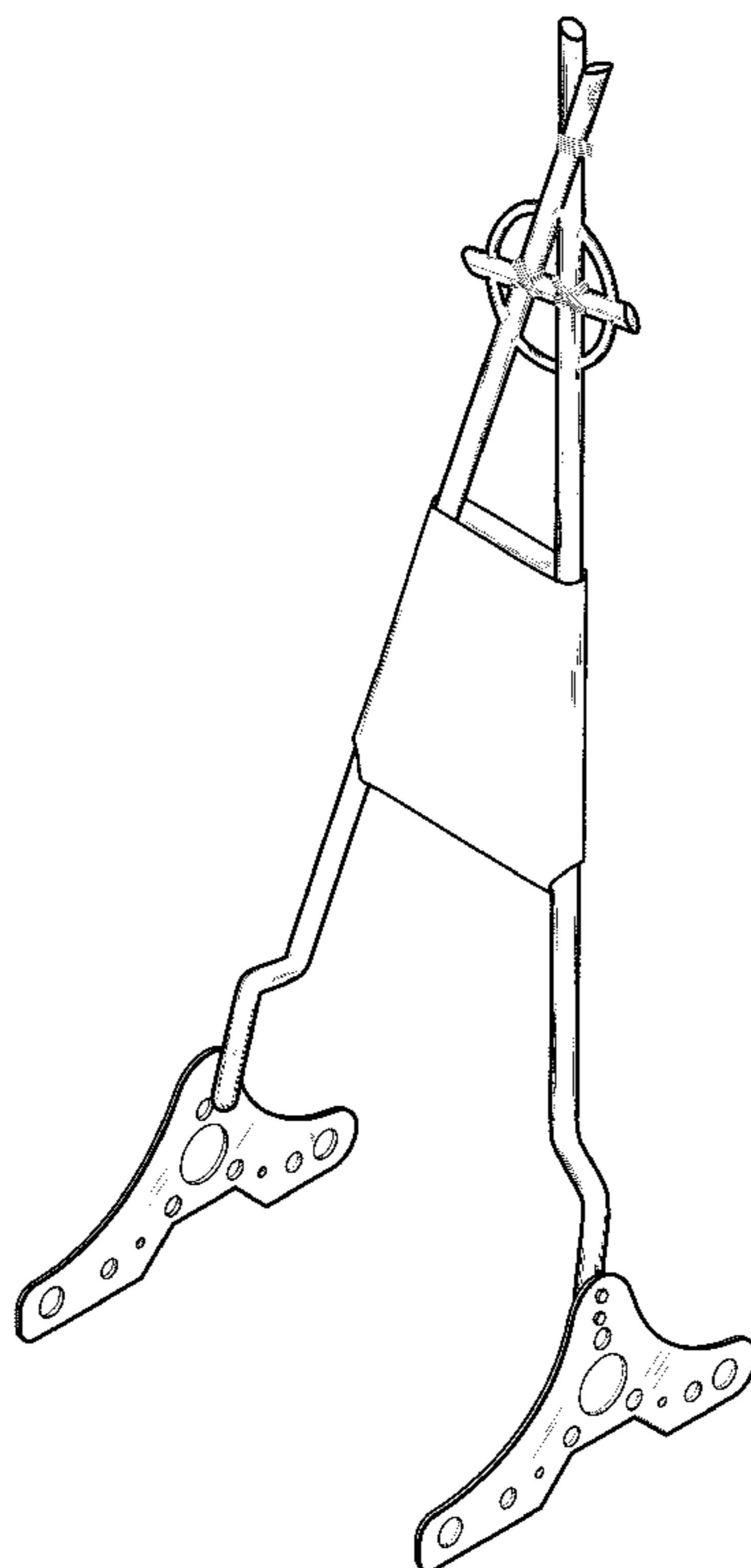

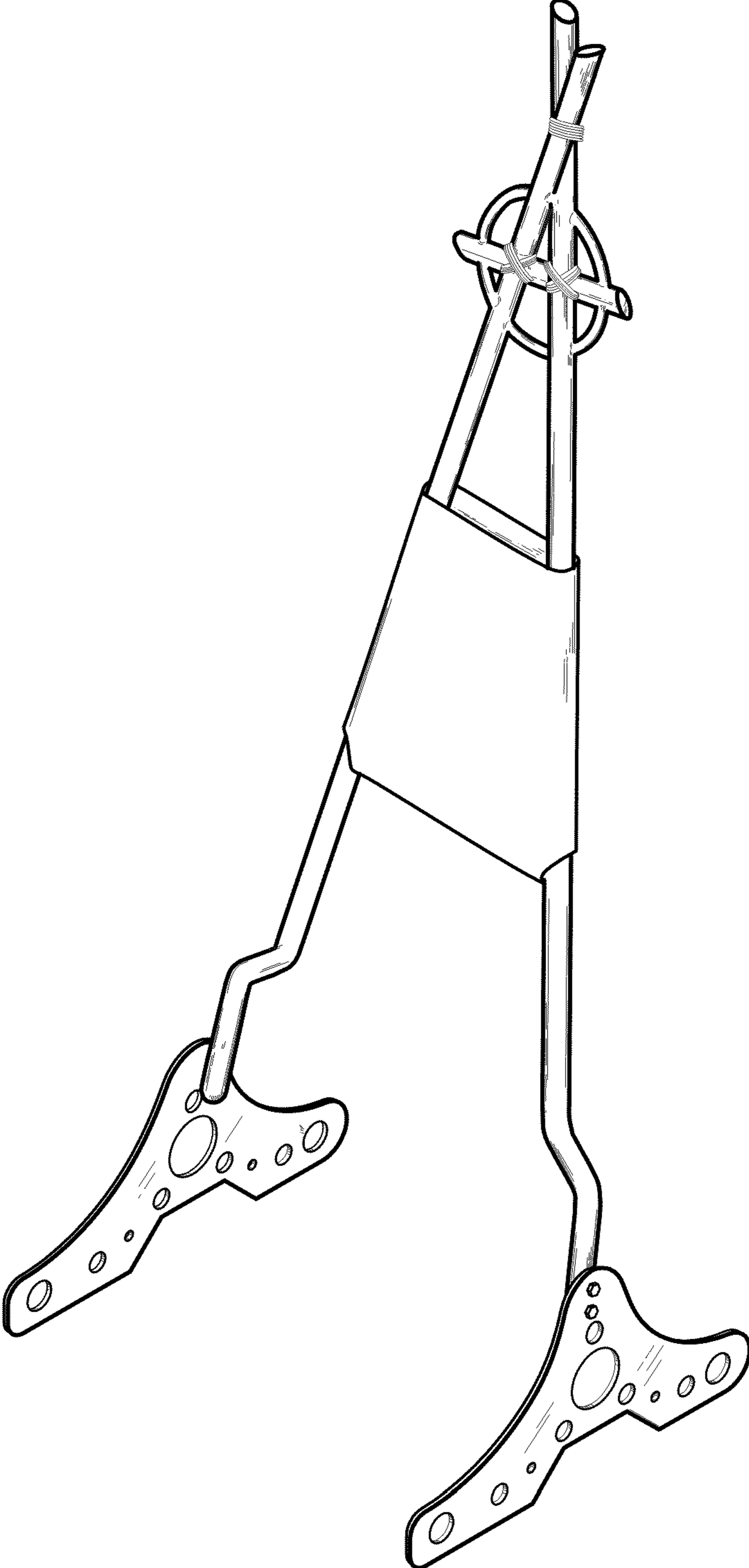

FIG. 1

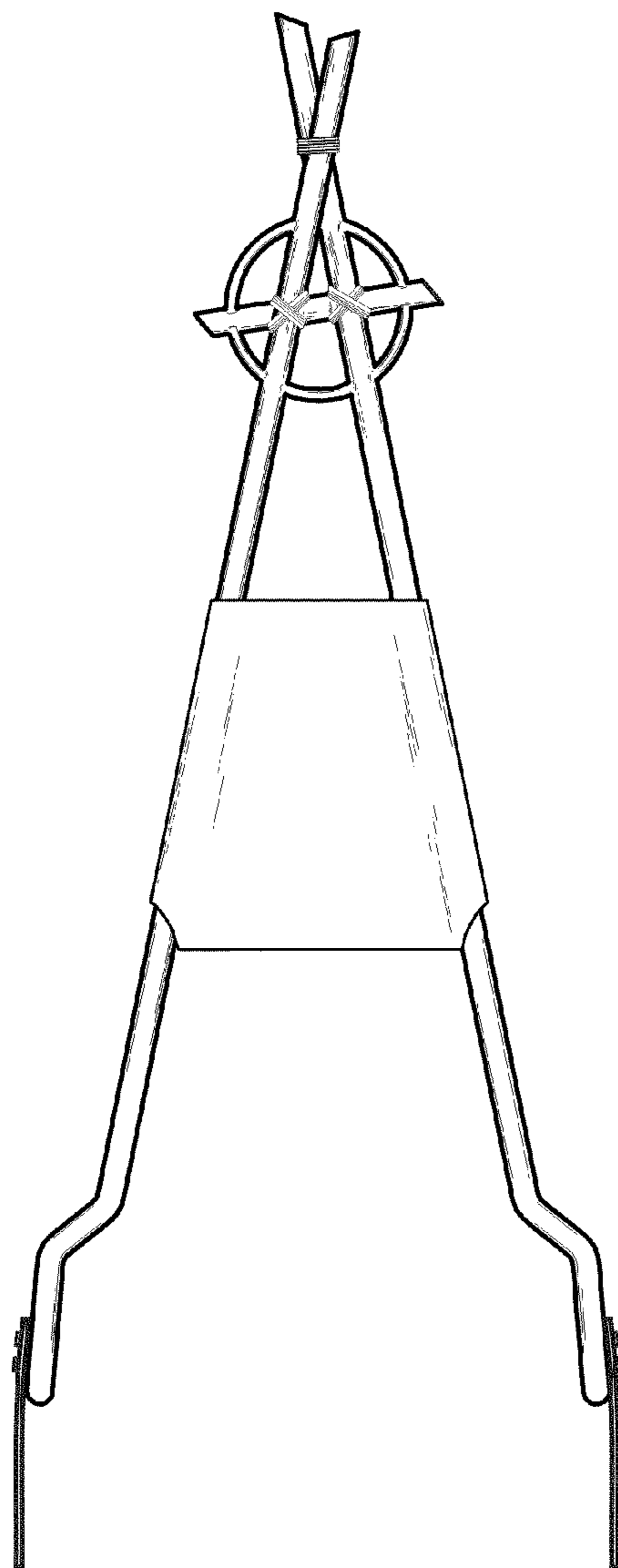

FIG. 2

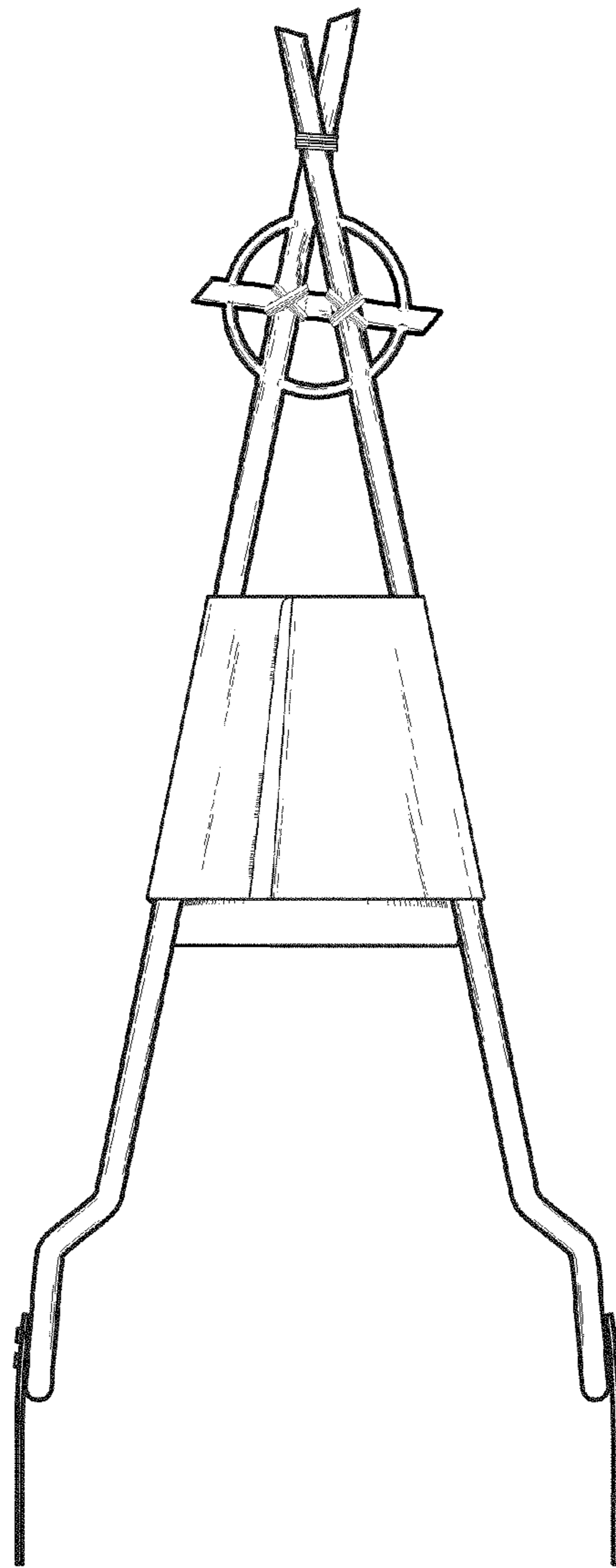

FIG. 3

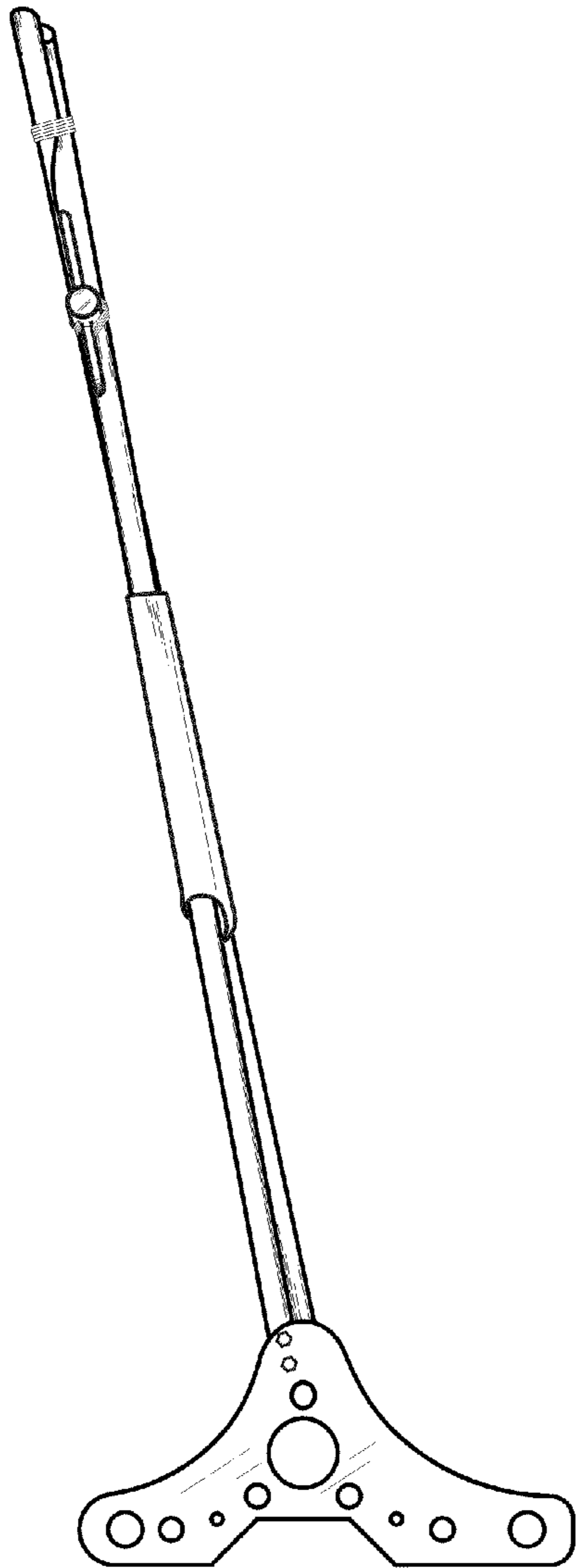

FIG. 4

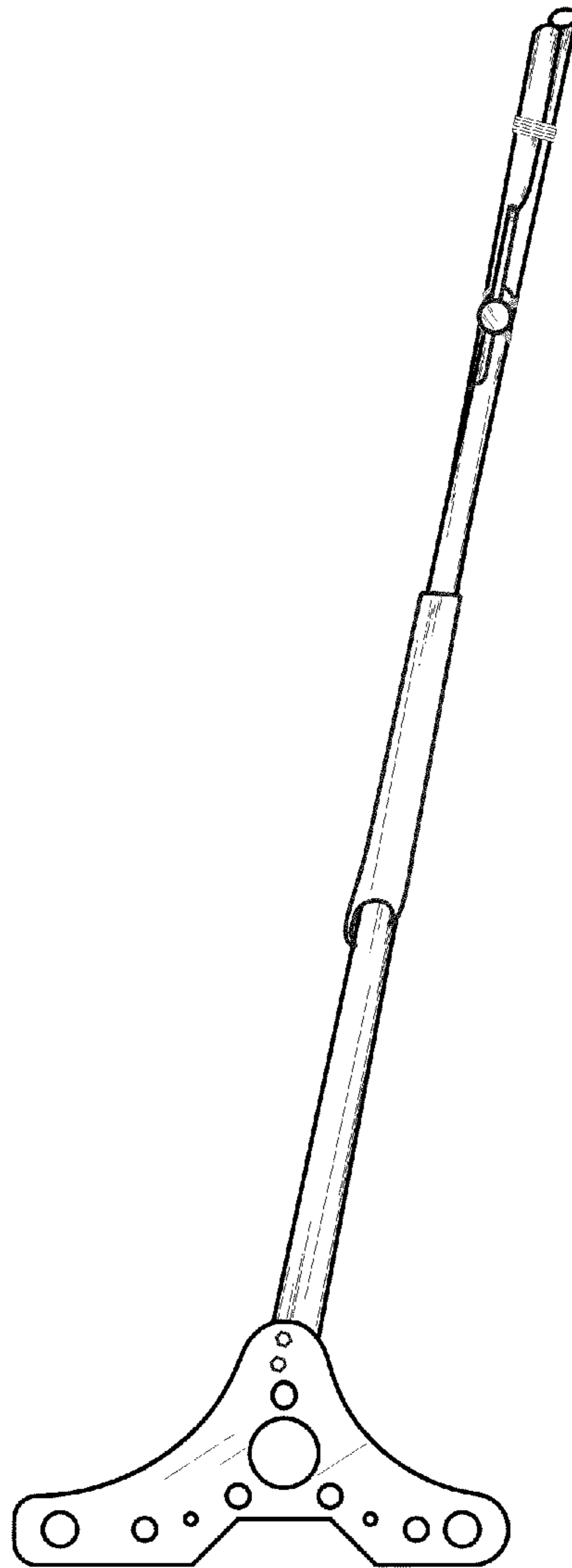

FIG. 5

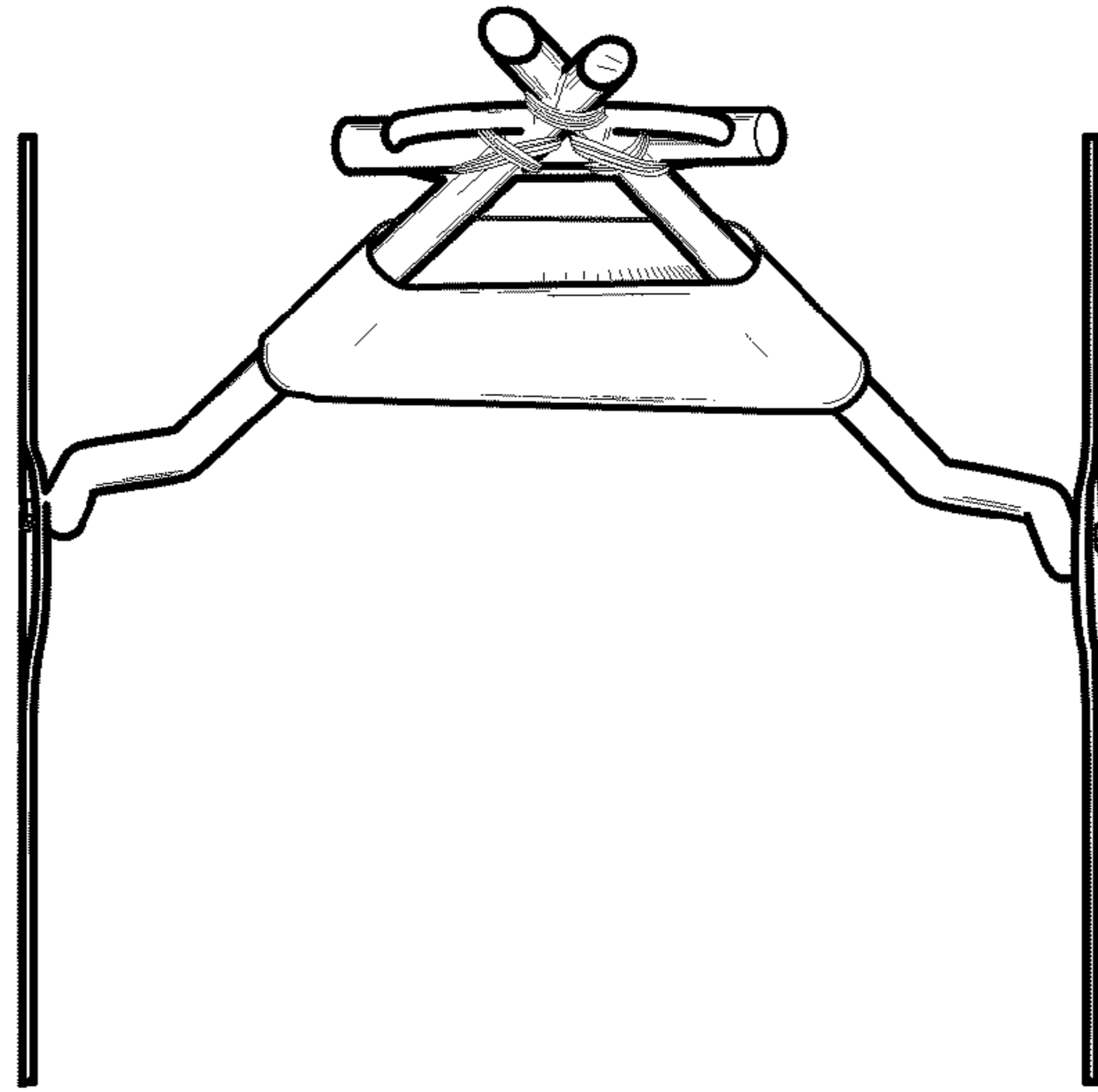

FIG. 6

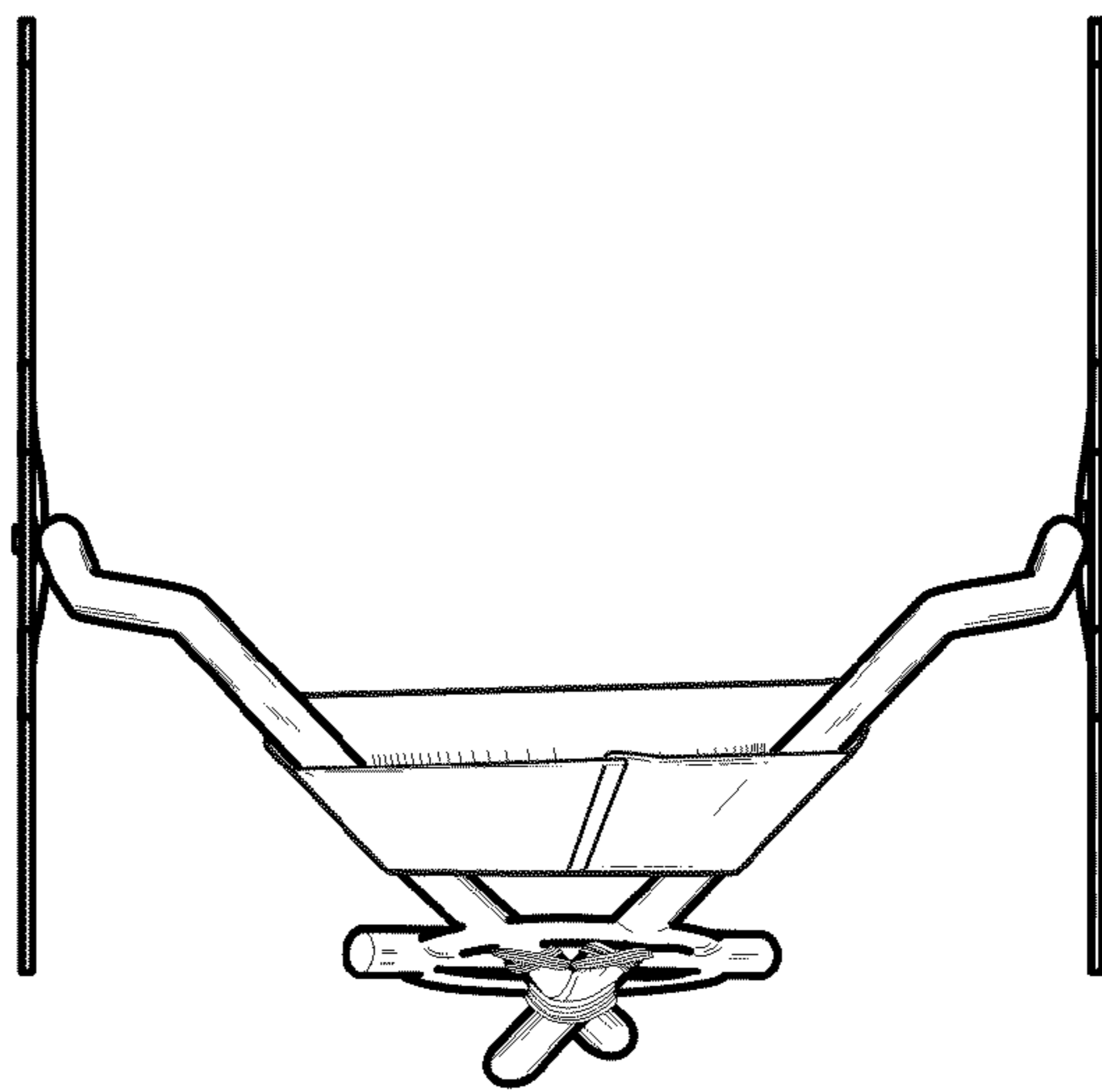

FIG. 7