



US00D639551S

(12) **United States Design Patent**
Romero et al.

(10) **Patent No.:** **US D639,551 S**
(45) **Date of Patent:** **** Jun. 14, 2011**

(54) **HANDBAG WITH INTERCHANGEABLE COVER**
(75) Inventors: **Michelle Romero**, West Valley City, UT (US); **Annette B. Cavaness**, Provo, UT (US); **Christian J. Seegmiller**, Riverton, UT (US)

(73) Assignee: **Miche Bag, LLC**, South Jordan, UT (US)

(**) Term: **14 Years**
(21) Appl. No.: **29/367,202**
(22) Filed: **Aug. 4, 2010**

Related U.S. Application Data

(63) Continuation-in-part of application No. 11/945,174, filed on Nov. 26, 2007.
(51) **LOC (9) Cl.** **03-01**
(52) **U.S. Cl.** **D3/233**
(58) **Field of Classification Search** D3/232-233, D3/240, 246, 318; 150/100, 103-110, 113-114, 150/118-119
See application file for complete search history.

(56) **References Cited**

U.S. PATENT DOCUMENTS

840,086	A	1/1907	Oswald	
1,042,934	A	9/1912	Levy	
1,960,396	A	5/1934	Rosenberg	
1,972,577	A	9/1934	Walinsky	
1,978,971	A	10/1934	Thornhill	
2,023,144	A	5/1935	Miller	
2,104,439	A	1/1938	Schein	
2,118,400	A	5/1938	Goldberg	
2,131,382	A	9/1938	Lobat	
D129,151	S	8/1941	Lewis	
D131,188	S	1/1942	Lewis	
2,369,239	A *	2/1945	Khoury	150/103
2,369,482	A	2/1945	Morris	
2,437,382	A	9/1948	Czap	
2,464,313	A	3/1949	Holden	
2,477,388	A	7/1949	Moore	

D155,608	S	10/1949	Hilf	
2,622,647	A *	12/1952	Arnthal	150/118
2,627,885	A *	2/1953	Cassell	150/105
2,656,870	A	10/1953	Wishnia	

(Continued)

FOREIGN PATENT DOCUMENTS

FR 1117240 5/1956

(Continued)

OTHER PUBLICATIONS

“The Smart Handbag”, The Bernina Connection, LLC Online Catalog with secure transactions, http://berninaconnection.com/cgi-bin/Store/store.cgi?product=patterns_main&productid=0 (accessed Mar. 21, 2007).

(Continued)

Primary Examiner — Holly Baynham

(74) *Attorney, Agent, or Firm* — Workman Nydegger

(57) **CLAIM**

The ornamental design for a handbag with interchangeable cover, as shown and described.

DESCRIPTION

FIG. 1 is a front perspective view of a handbag with interchangeable handbag cover, with the opposing rear view being a mirror image thereof;
FIG. 2 is a front perspective view thereof showing the handbag cover in a partially opened position with respect to the base handbag;
FIG. 3 is a front elevational view of the handbag cover shown in FIG. 1 with the opposing rear view being a mirror image thereof;
FIG. 4 is a top plan view thereof;
FIG. 5 is an elevated left view thereof, with the opposing right view being a mirror image thereof; and,
FIG. 6 is an elevated bottom view thereof.
The claimed design is shown broken away to indicate indeterminate length.

1 Claim, 3 Drawing Sheets

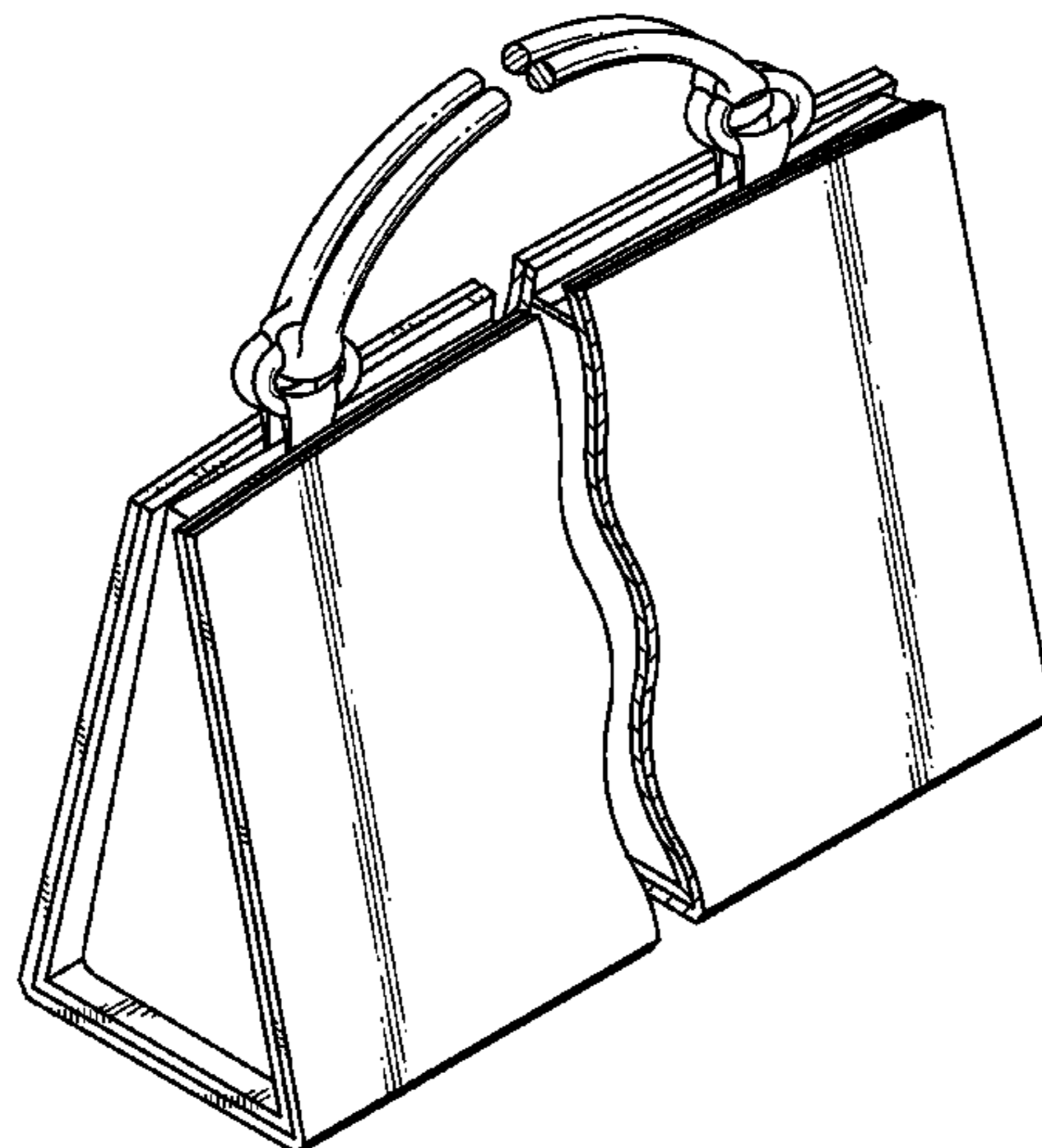

US D639,551 S

Page 2

U.S. PATENT DOCUMENTS

2,779,373	A	1/1957	Koepke	
2,809,685	A	10/1957	Lowy	
2,893,457	A	7/1959	Wilson	
3,182,701	A	5/1965	Ginsburg	
3,234,985	A	2/1966	Gilbert	
3,451,545	A	6/1969	Davis	
3,556,187	A	1/1971	Speakes	
3,575,226	A	4/1971	Chapman	
D224,072	S	6/1972	Rosenblum	
3,669,169	A *	6/1972	Lubliner	150/107
4,088,167	A	5/1978	Schwartz	
4,112,991	A	9/1978	Barbaresi	
D252,596	S	8/1979	Adler	
4,260,004	A	4/1981	Domke	
4,263,951	A	4/1981	Siegel	
4,610,286	A	9/1986	Cyr	
4,754,790	A	7/1988	Meyers	
4,842,032	A	6/1989	Mastronardo	
4,907,633	A	3/1990	Eckstein	
5,096,030	A	3/1992	Espinosa	
5,178,198	A	1/1993	Fitzgerald	
D334,661	S	4/1993	Kohn	
5,207,254	A	5/1993	Fromm	
D346,694	S	5/1994	Cyr	
5,356,004	A	10/1994	Weinrab	
D354,399	S	1/1995	Georges	
5,533,558	A	7/1996	Carey	
5,725,039	A	3/1998	Macinai	
5,765,618	A	6/1998	Toledano	
5,829,502	A	11/1998	Distefano	
D403,863	S	1/1999	Briganti	
D408,146	S	4/1999	Briganti	
5,894,975	A	4/1999	Holden	
5,911,262	A	6/1999	Steinhart	
5,839,138	A	11/1999	Smith	
5,983,464	A	11/1999	Bauer	
5,983,969	A	11/1999	Morgan	
6,003,573	A	12/1999	Owens	
6,029,723	A	2/2000	Baquero	
6,116,412	A	9/2000	Rogers	
D432,310	S	10/2000	Salz	
6,129,126	A	10/2000	Restivo	
6,173,837	B1	1/2001	Marconi	
6,179,025	B1	1/2001	Sutton	
D437,687	S	2/2001	Salz	
6,186,201	B1	2/2001	Salz	
6,237,660	B1	5/2001	Giardino	
D443,139	S	6/2001	Salz	
D443,764	S	6/2001	Salz	
D444,943	S	7/2001	Nastasi	
6,394,157	B2	5/2002	Luna	
6,422,278	B1	7/2002	Grogan	
6,446,688	B1	9/2002	Sutton	
6,543,499	B2	4/2003	McCreery	
6,564,838	B1	5/2003	Cruikshank	
D476,809	S	7/2003	Ko	
D495,877	S	9/2004	Thorsen	
6,796,344	B2	9/2004	Chen	
6,807,992	B2	10/2004	Powers	
D497,716	S	11/2004	de Baschmakoff	
6,820,664	B1	11/2004	Ritch	
6,968,880	B2	11/2005	Battaglia	
6,971,424	B1	12/2005	Angevine	
7,028,730	B2	4/2006	Pace	

7,222,649	B1	5/2007	Fox
7,461,676	B2	12/2008	Huie
D610,081	S	2/2010	DeSorbo
D611,705	S	3/2010	Romero
D613,062	S	4/2010	Romero
2001/0015248	A1	8/2001	McCreery
2002/0029831	A1	3/2002	Pendergrass
2002/0066505	A1	6/2002	Grogan
2003/0000612	A1	1/2003	Sutton
2003/0177664	A1	9/2003	Monassebian
2004/0050468	A1	3/2004	Powers
2004/0187988	A1	9/2004	Andrews
2005/0028908	A1	2/2005	Schaus
2005/0173034	A1	8/2005	Antrobus
2005/0274441	A1	12/2005	Pace
2006/0021684	A1	2/2006	DeCoro, III
2006/0157175	A1	7/2006	Pace
2006/0174984	A1	8/2006	Burns
2006/0208043	A1	9/2006	Plantan
2006/0237106	A1	10/2006	Pearson
2006/0266452	A1	11/2006	Huie
2006/0278311	A1	12/2006	Mittelstaedt
2007/0102077	A1	5/2007	Parker-Ogden
2007/0163689	A1	7/2007	Pace
2007/0209742	A1	9/2007	Morgan
2007/0221136	A1	9/2007	Buttner
2007/0240798	A1	10/2007	Bihler
2008/0006355	A1	1/2008	Gomez
2008/0185082	A1	8/2008	Mejia
2008/0230158	A1	9/2008	Romero
2009/0065110	A1	3/2009	Cassella
2009/0188592	A1	7/2009	Connacher
2010/0218863	A1	9/2010	Church et al.

FOREIGN PATENT DOCUMENTS

GB	2350285	A1	11/2000
GB	2377882	A1	1/2003
JP	2002051816		2/2002
KR	20-030050218		5/2004
WO	2001091596		12/2001
WO	2005008552	A1	1/2005
WO	2006002005	A2	1/2006
WO	2006122197		11/2006

OTHER PUBLICATIONS

“Rock Album Cover Tote Bag with interchangeable panel”, Eco-Artware, <http://www.eco-artware.com/catalog/MMM1-album-tote.shtml> (accessed Mar. 21, 2007).

International Search Report, PCT/US2007/085339, Mailed Mar. 14, 2008.

International Search Opinon, PCT/US2007/085339, Mailed Mar. 14, 2008.

European Search Report, 07845129.1-1258/2124666, Mailed Mar. 25, 2010.

European Search Report, 09014069.0-1258/2163169, Mailed May 3, 2010.

International Search Opinion, PCT/US2009/054896, Mailed Oct. 30, 2009.

Office Action Mailed Oct. 27, 2009, U.S. Appl. No. 29/320,888.

Office Action Mailed Mar. 9, 2010, U.S. Appl. No. 11/945,174.

Office Action Mailed Jun. 23, 2010, U.S. Appl. No. 11/945,174.

* cited by examiner

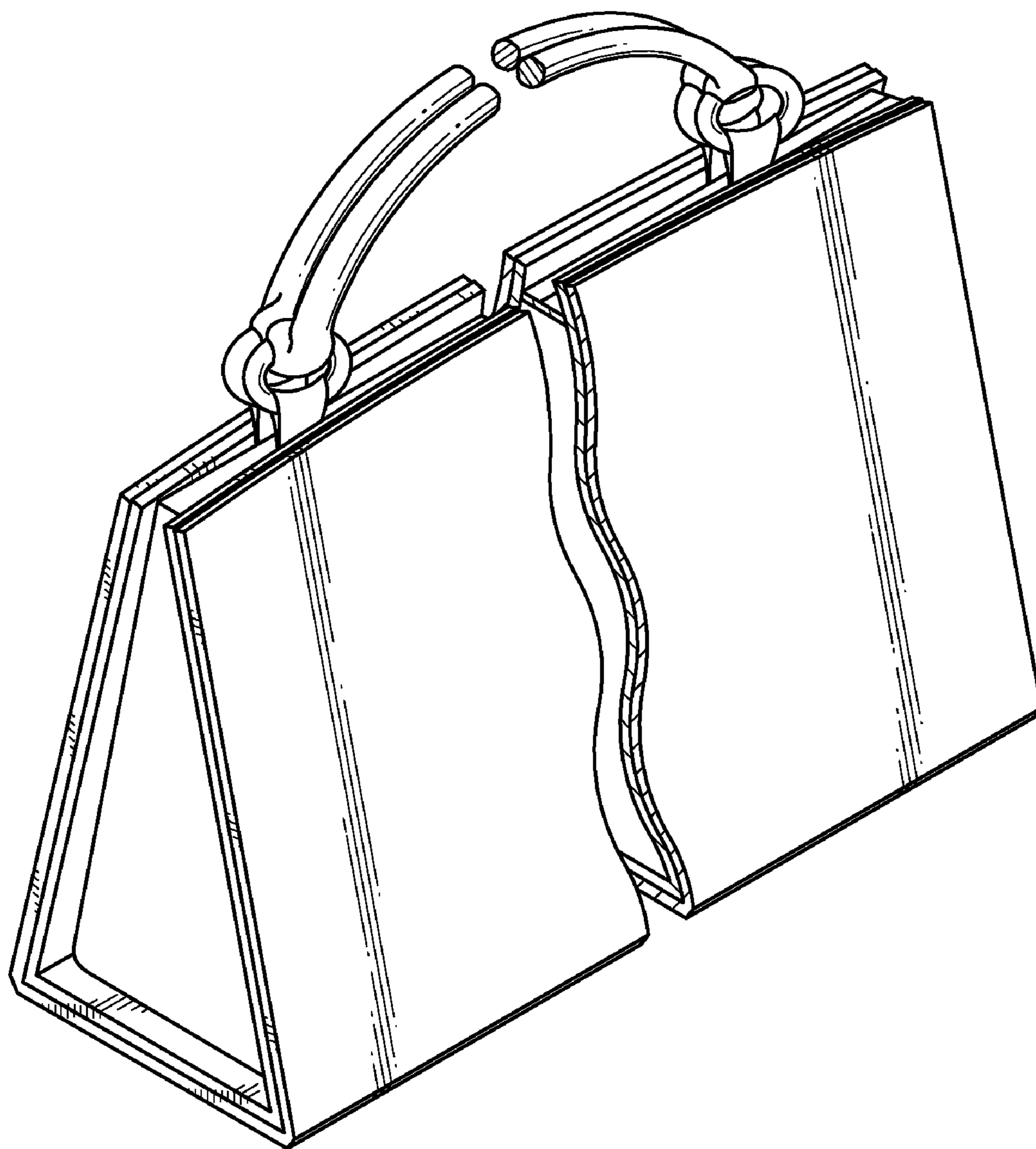

Fig. 1

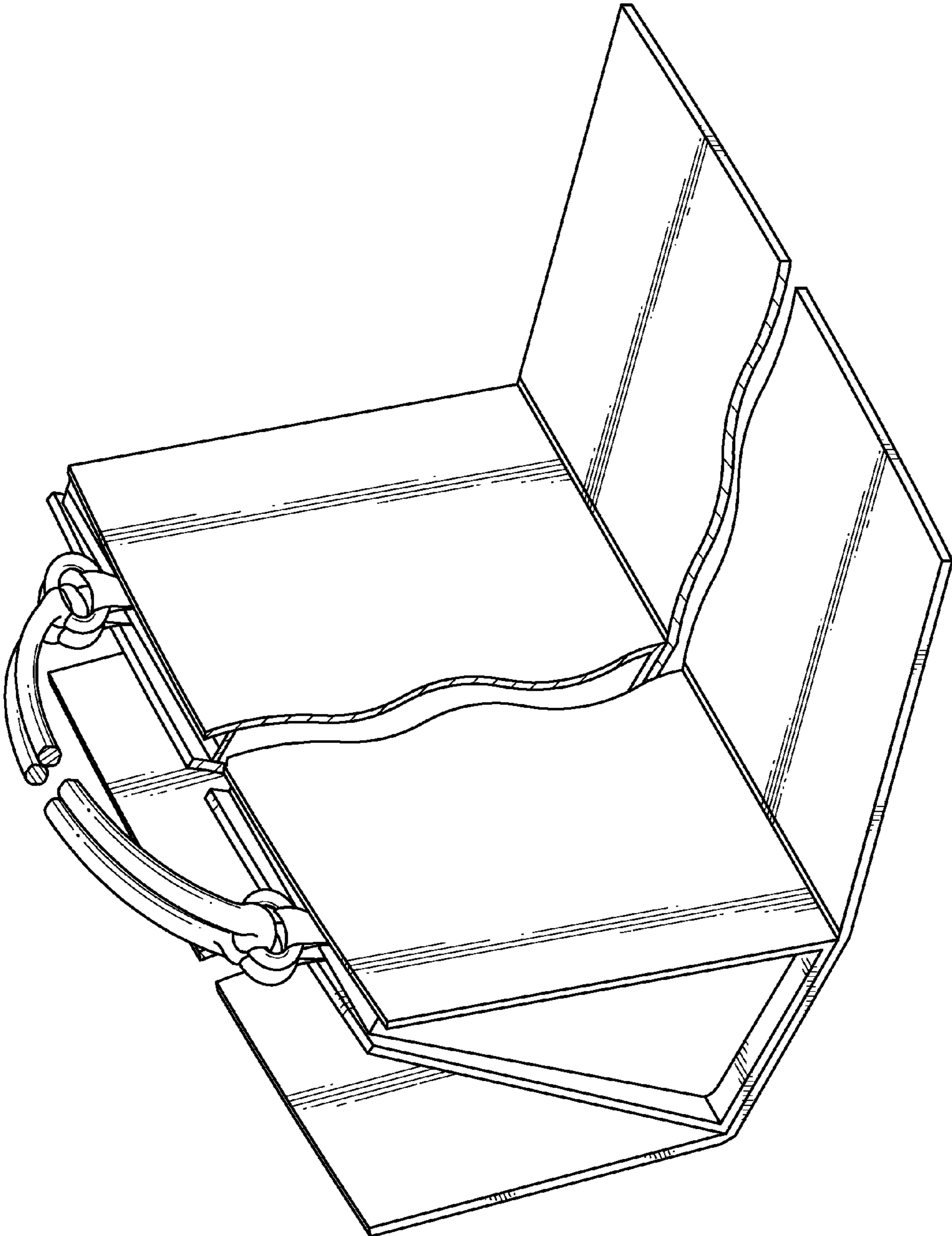

Fig. 2

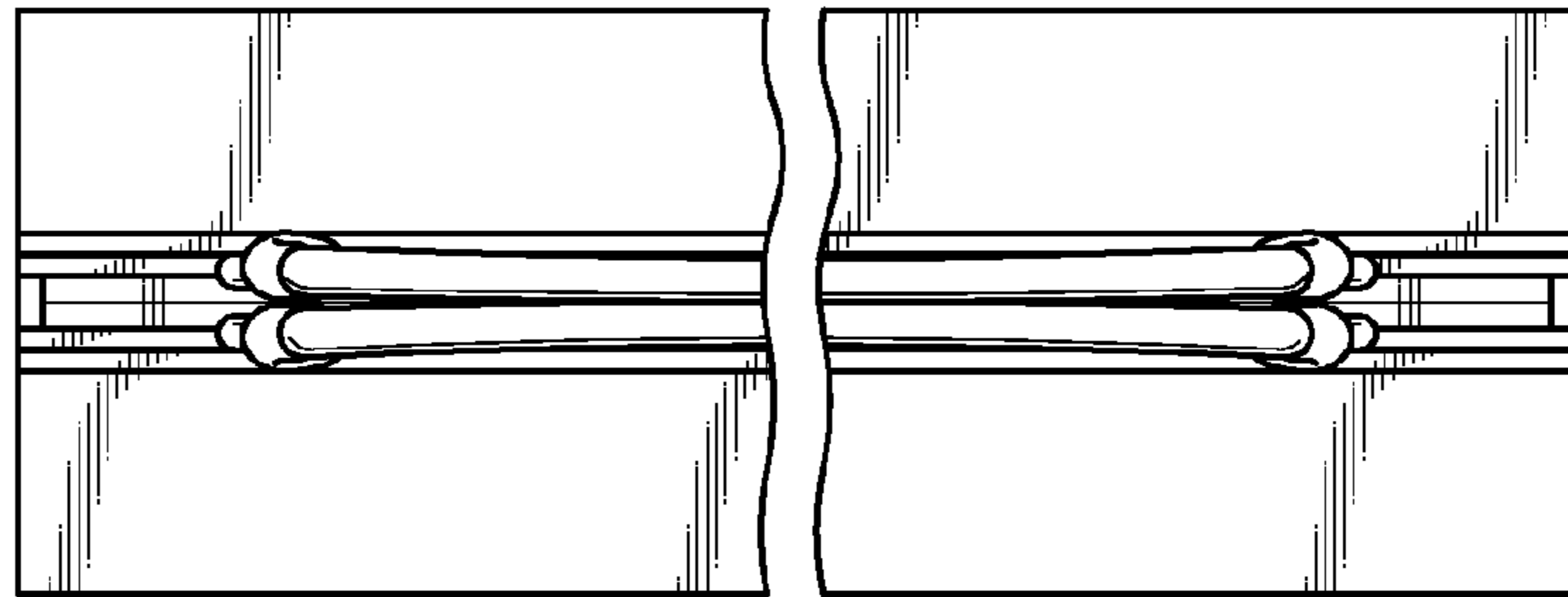

Fig. 4

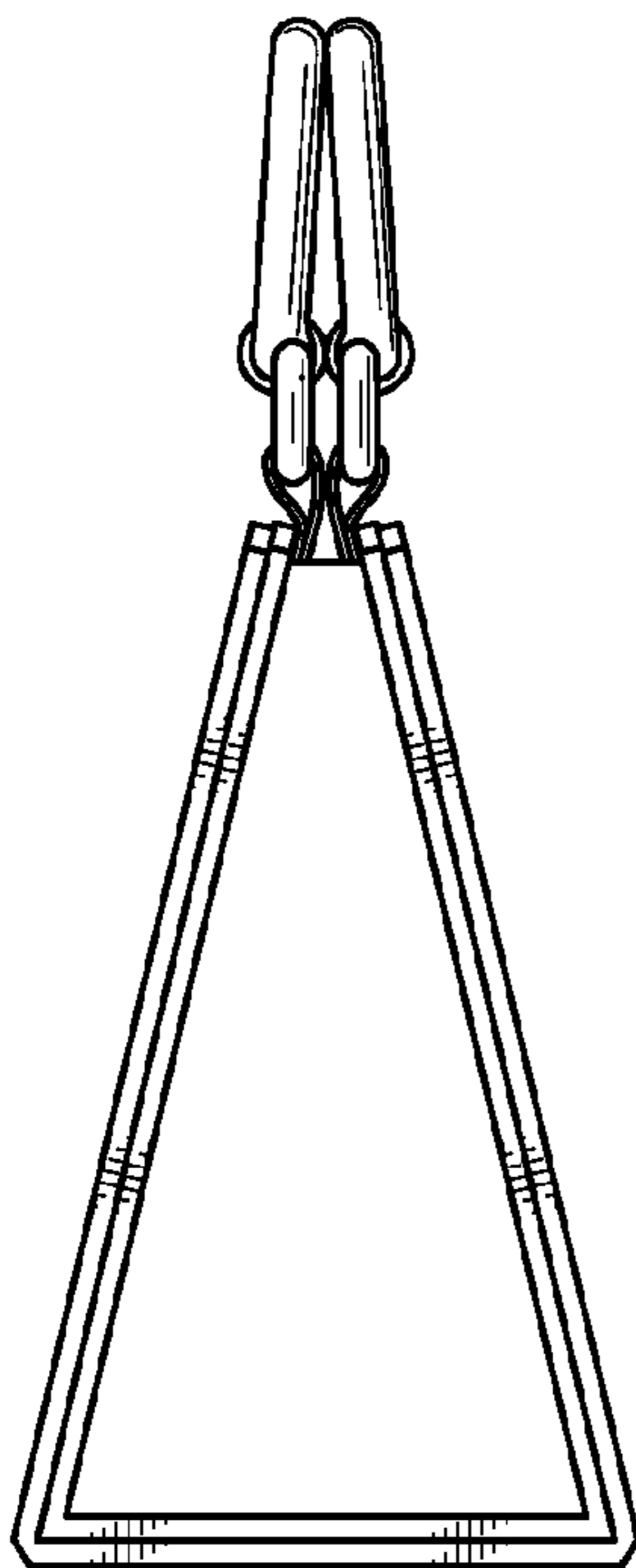

Fig. 5

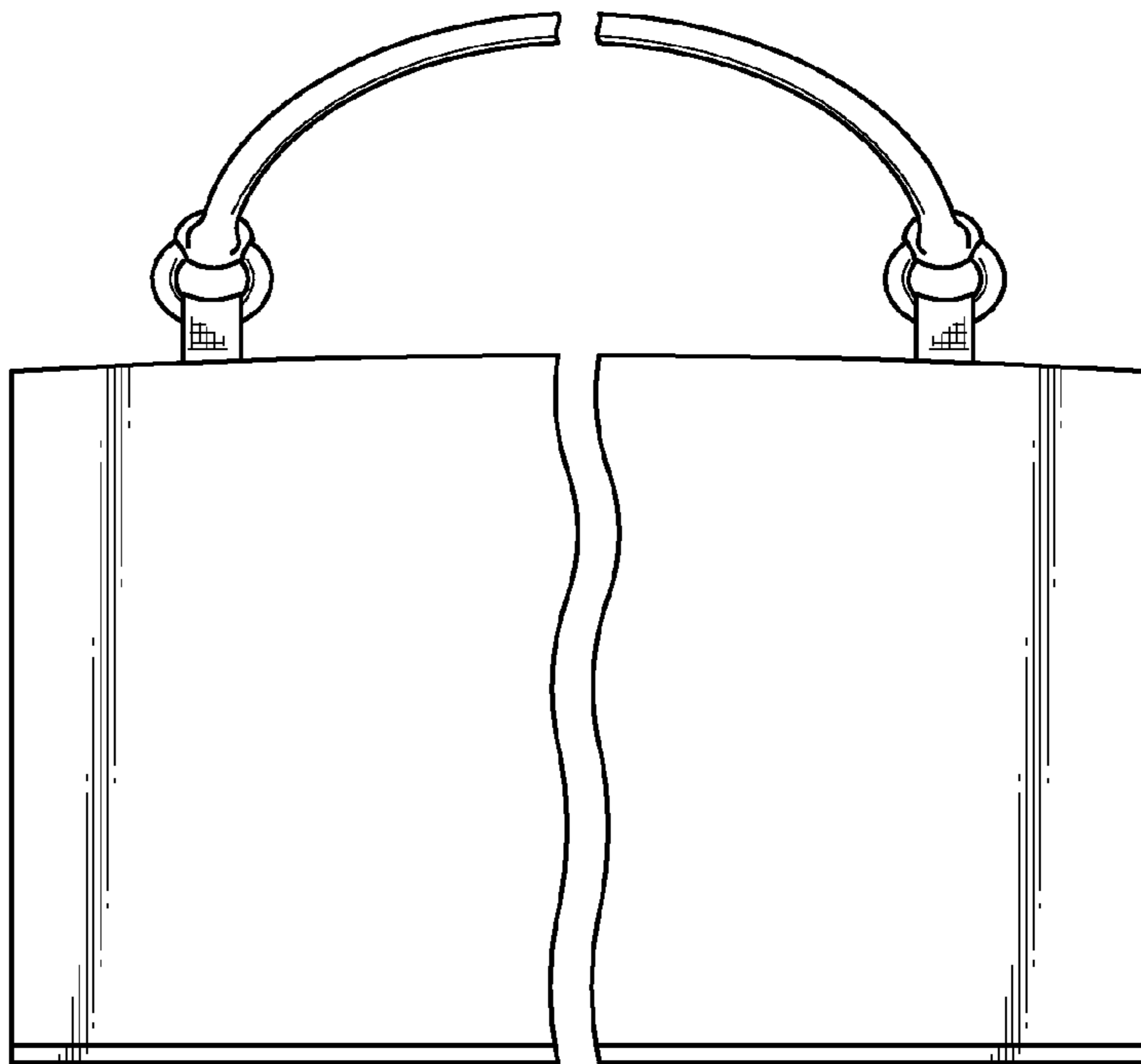

Fig. 3

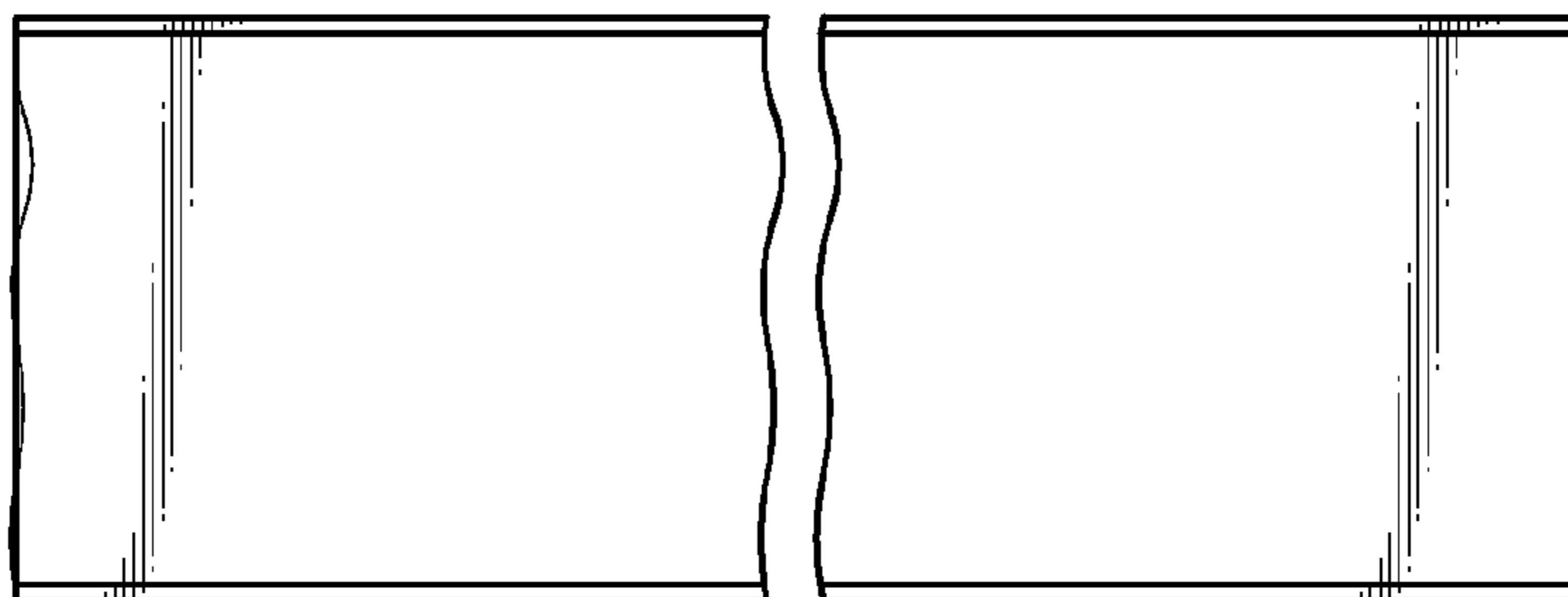

Fig. 6