



US00D639537S

(12) **United States Design Patent**
Countee et al.

(10) **Patent No.:** **US D639,537 S**

(45) **Date of Patent:** **** Jun. 14, 2011**

(54) **INTERCHANGEABLE SHOE UPPER**

(76) Inventors: **Keita L. Countee**, Torrance, CA (US);
Kenneth Yu, Torrance, CA (US)

(**) Term: **14 Years**

(21) Appl. No.: **29/383,176**

(22) Filed: **Jan. 13, 2011**

(51) **LOC (9) Cl.** **02-04**

(52) **U.S. Cl.** **D2/923; D2/976**

(58) **Field of Classification Search** D2/896,
D2/897, 907, 923, 946, 969, 972, 973, 976,
D2/978; 36/1, 8.3, 45-58, 104, 108, 76 R,
36/100, 101, 136, 15, 127, 114
See application file for complete search history.

(56) **References Cited**

U.S. PATENT DOCUMENTS

2,801,477	A *	8/1957	Adams et al.	40/636
3,032,896	A *	5/1962	Weaver	36/101
4,333,248	A *	6/1982	Samuels	36/72 R
4,697,362	A *	10/1987	Wasserman	36/136
4,805,321	A *	2/1989	Tonkel	36/54
D335,949	S *	6/1993	Rogers	D2/972
5,778,564	A *	7/1998	Kettner	36/101
5,848,484	A *	12/1998	Dupree et al.	36/101
6,212,797	B1 *	4/2001	Merry et al.	36/101

D441,942	S	5/2001	Kelchak	
D493,028	S *	7/2004	Len	D2/976
6,874,256	B2	4/2005	Delgatty	
D514,285	S *	2/2006	Jarmon Mouchi et al.	D2/946
7,210,251	B1	5/2007	Rolle	
D550,446	S *	9/2007	Levesy	D2/976
7,698,834	B1 *	4/2010	Courville	36/15
2003/0192205	A1	10/2003	Linens	
2003/0233772	A1	12/2003	Musial	
2005/0005478	A1	1/2005	James	
2006/0143951	A1	7/2006	Yang et al.	
2008/0235993	A1	10/2008	Wegner	

* cited by examiner

Primary Examiner — Rob Spear
Assistant Examiner — Rashida C McCoy

(57) **CLAIM**

The ornamental design for an interchangeable shoe upper, as shown and described.

DESCRIPTION

FIG. 1 is a side view of an interchangeable shoe upper showing my new design;
FIG. 2 is an opposite side view thereof;
FIG. 3 is a front view thereof;
FIG. 4 is a back view thereof;
FIG. 5 is a top view thereof; and,
FIG. 6 is a bottom view thereof.
In FIG. 3 and FIG. 5, the broken lines showing are stitch marks and form no part of the claimed design.

1 Claim, 6 Drawing Sheets

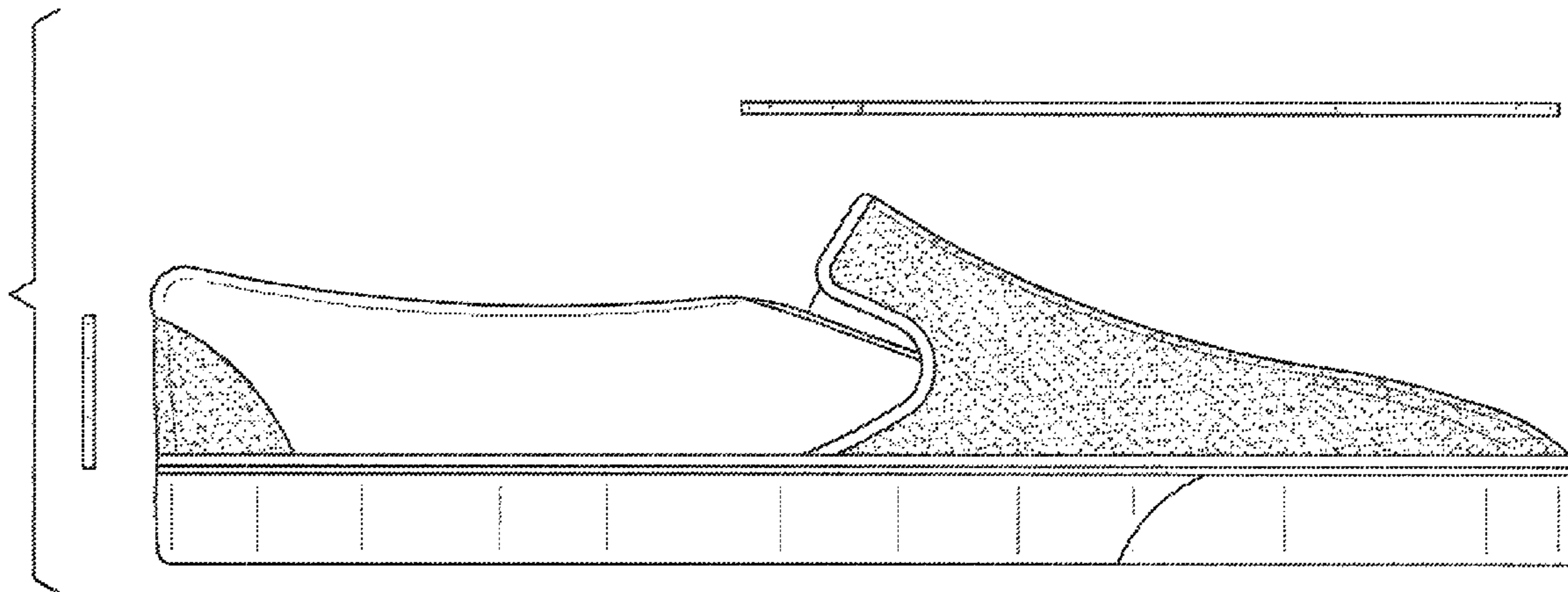

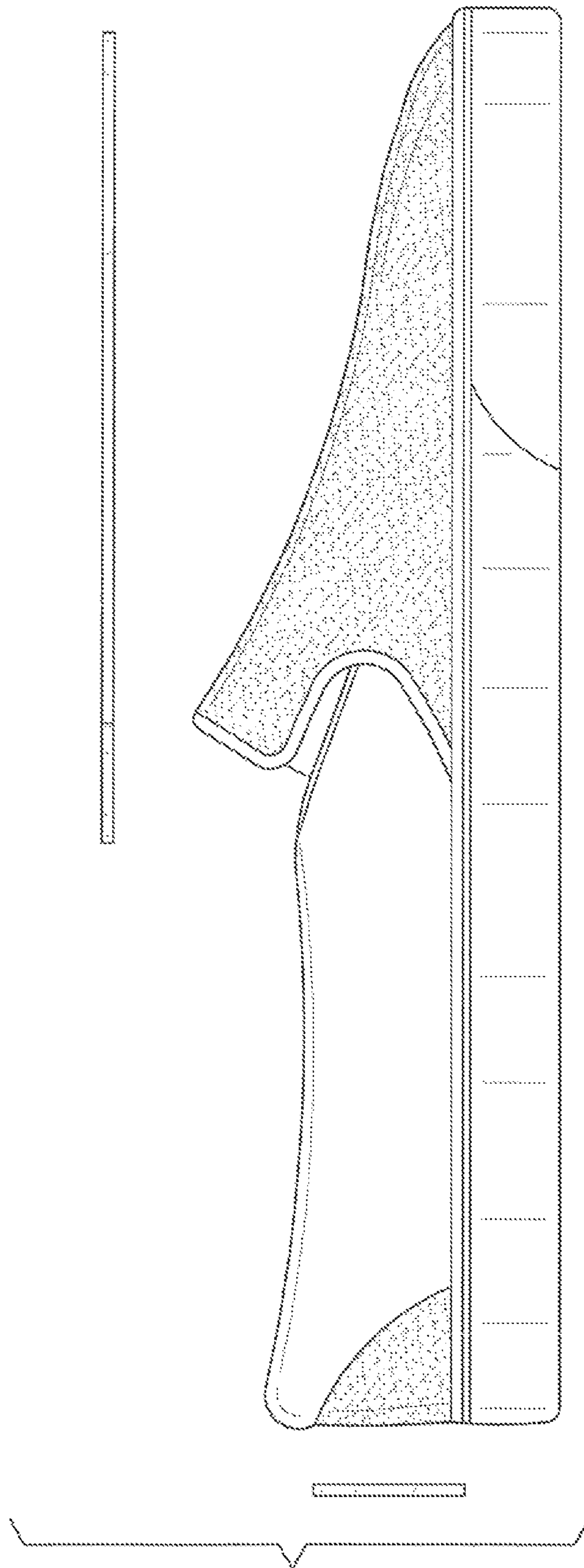

FIG. 1

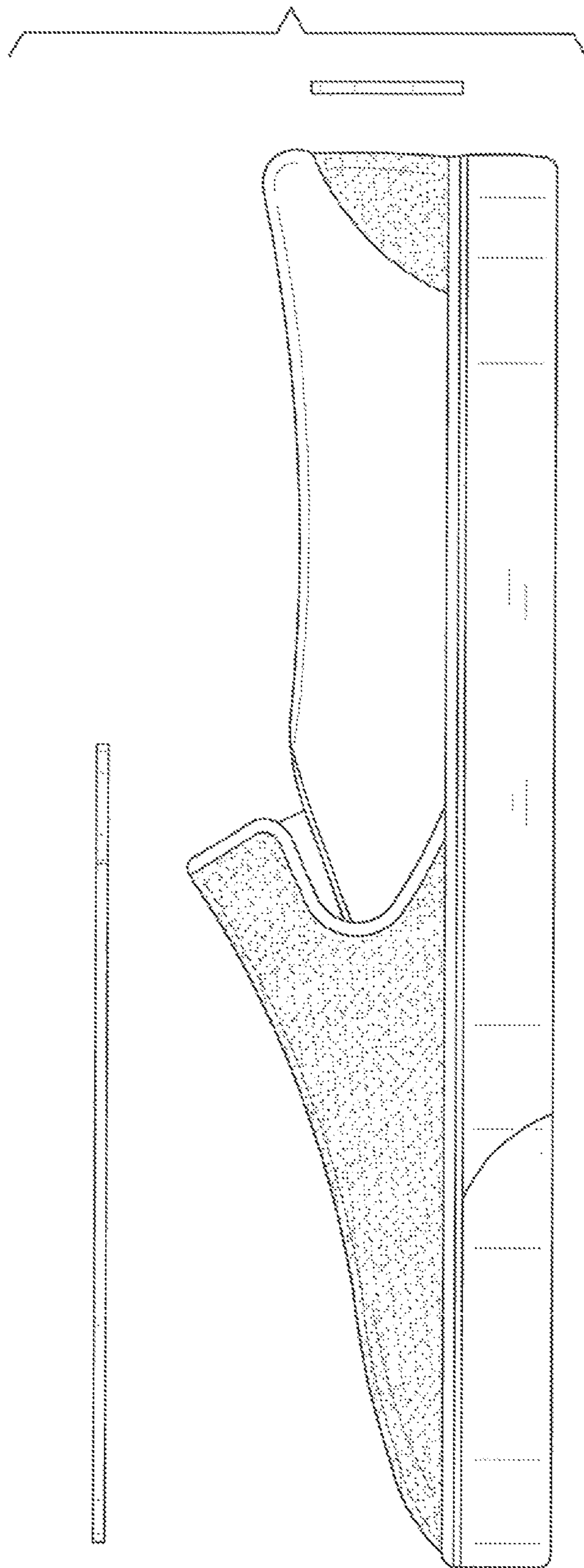

FIG. 2

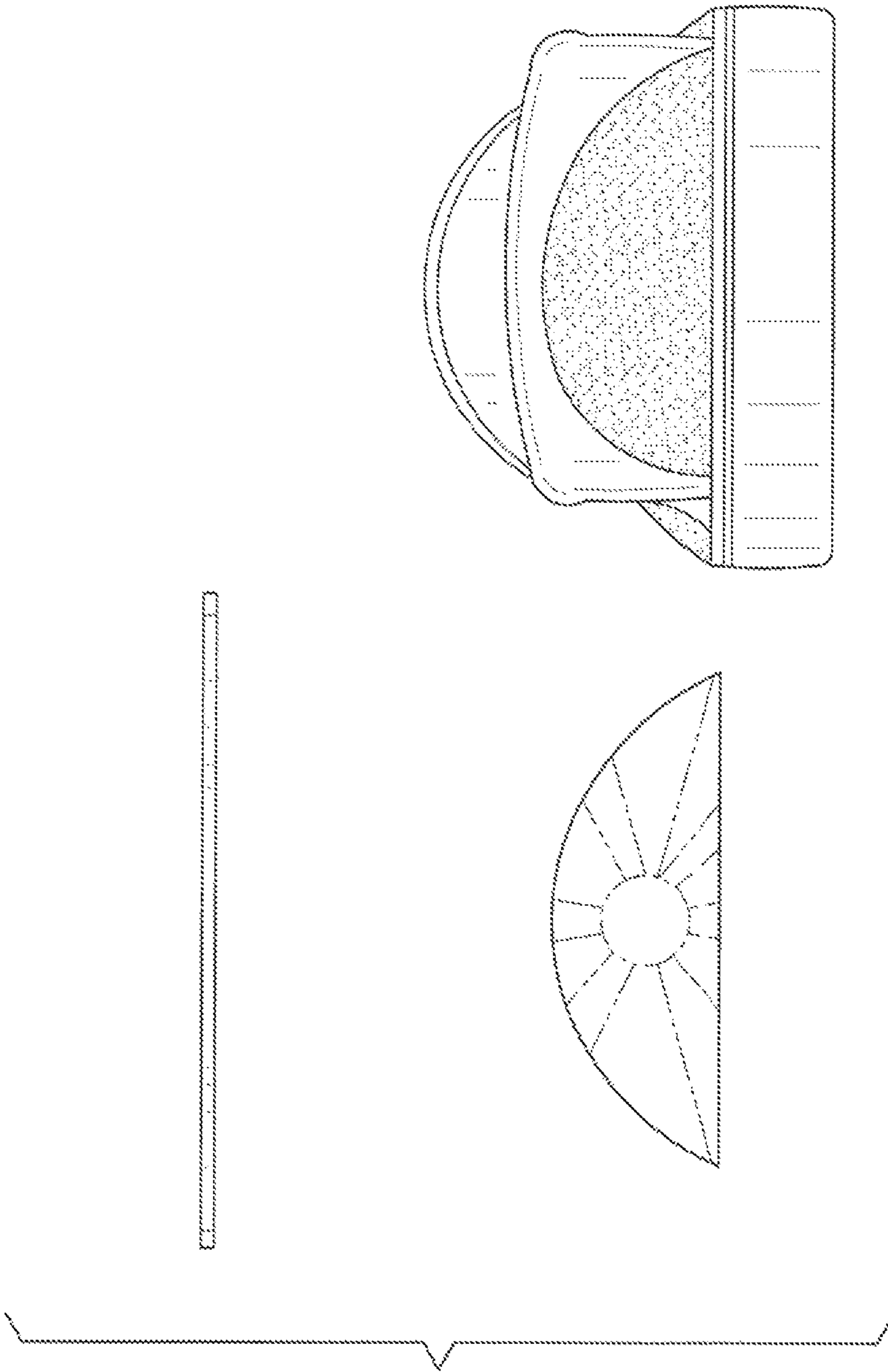

FIG. 3

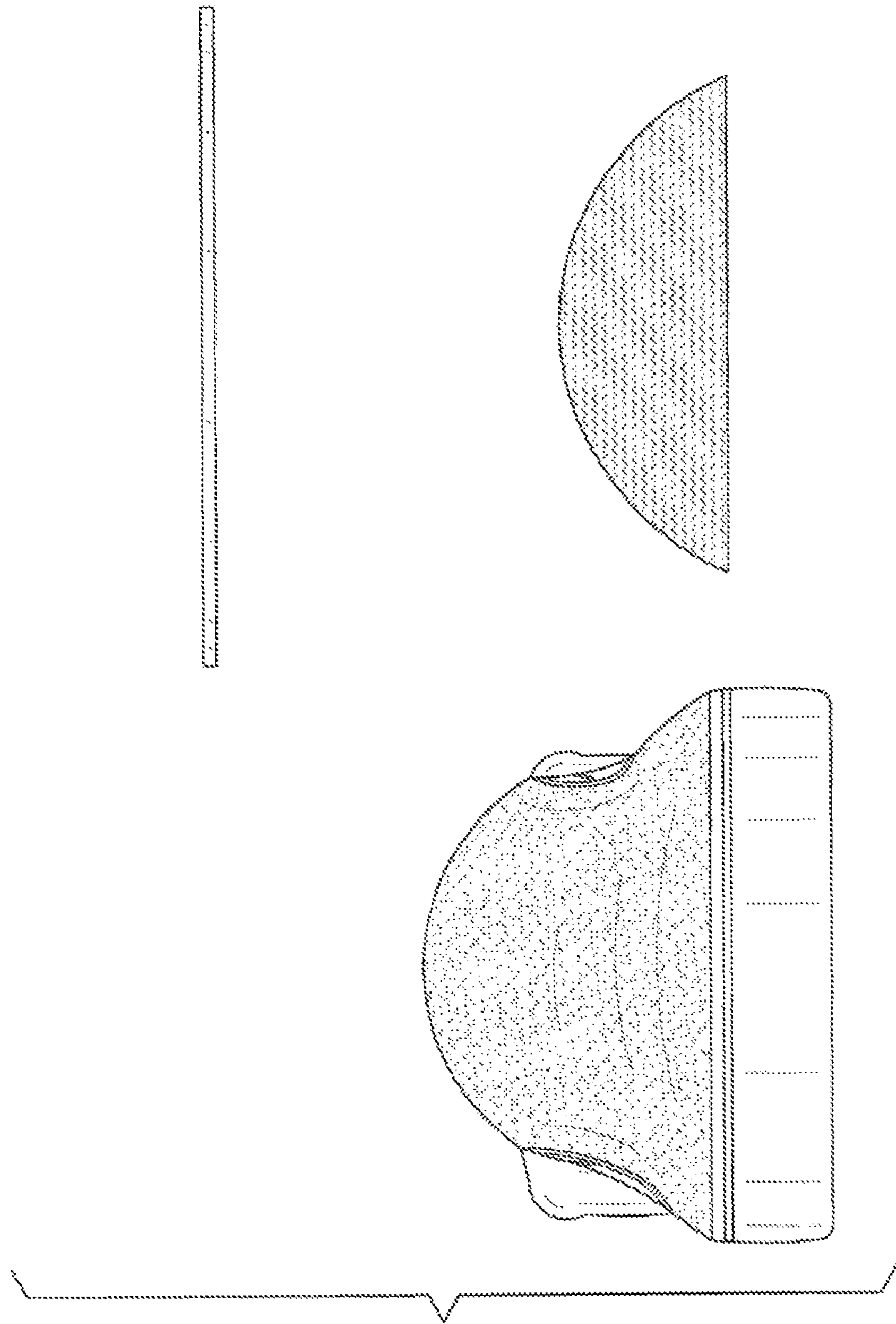

FIG. 4

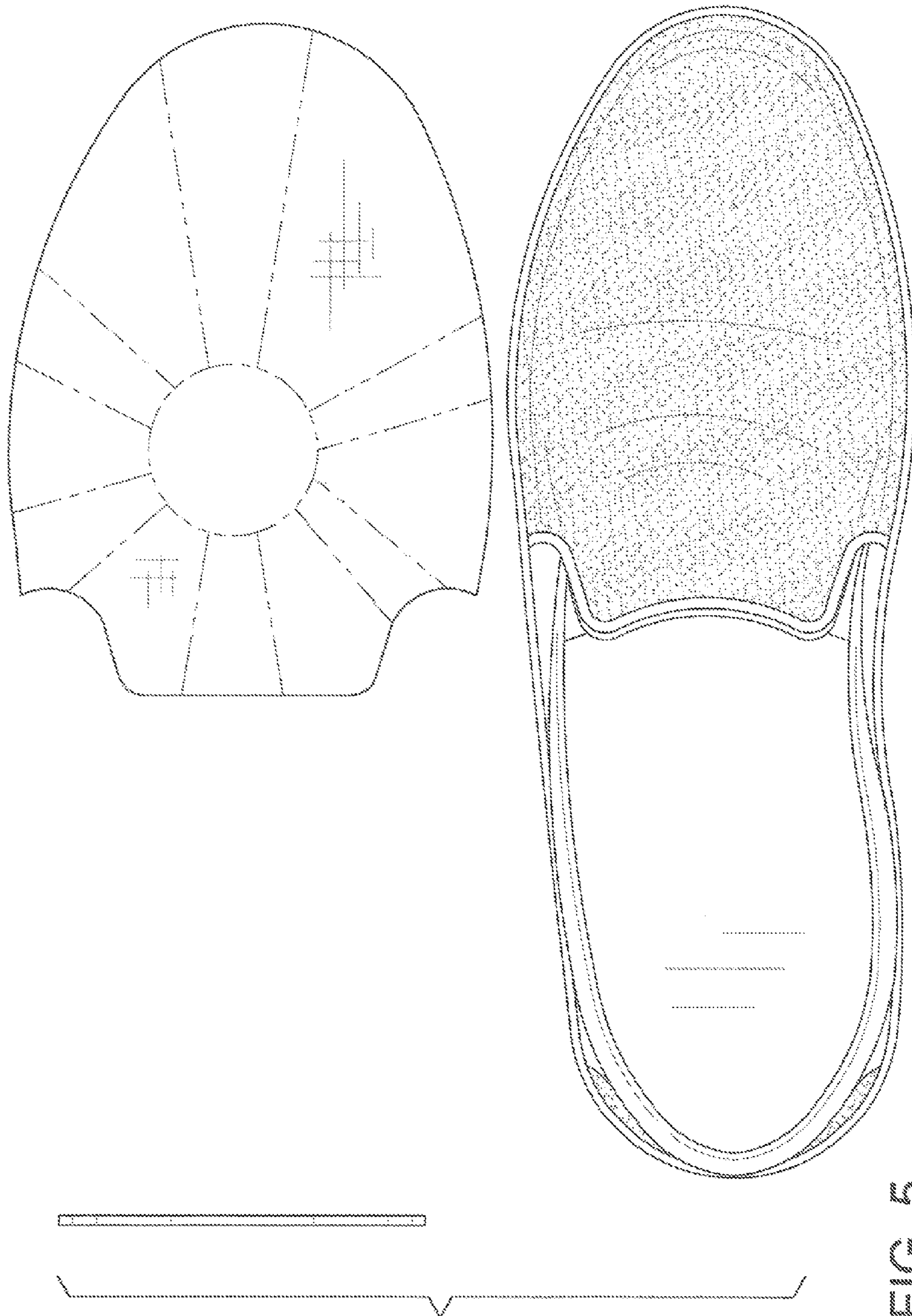

FIG. 5

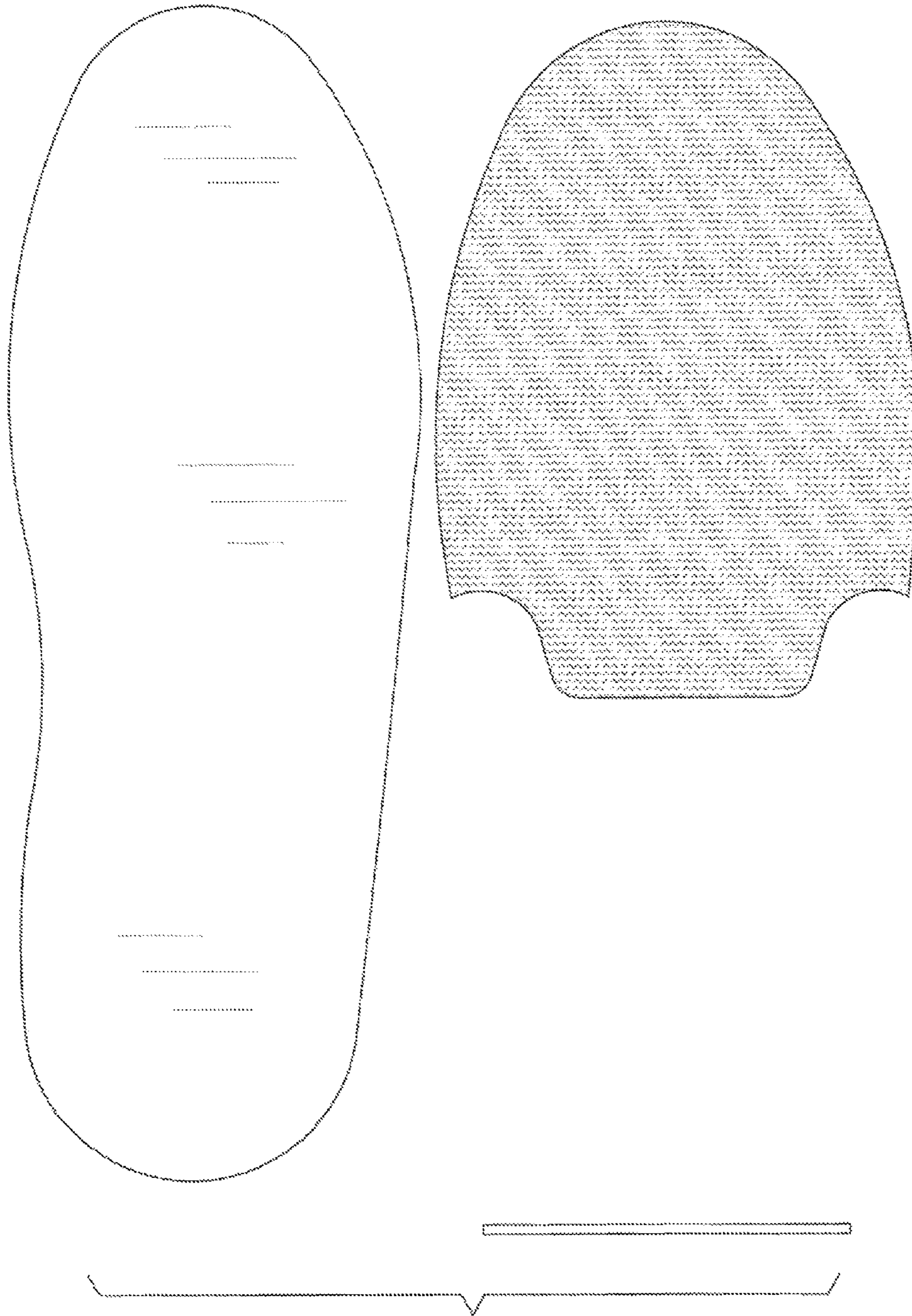

FIG. 6