



US00D639478S

(12) **United States Design Patent**  
**Nguyen et al.**

(10) **Patent No.:** **US D639,478 S**  
(45) **Date of Patent:** **\*\* Jun. 7, 2011**

(54) **LIGHTING DEVICE**

(75) Inventors: **Loc Nguyen**, Santa Ana, CA (US);  
**Douglas J. Port**, Huntington Beach, CA  
(US)

(73) Assignee: **SureFire, LLC**, Fountain Valley, CA  
(US)

(\*\*) Term: **14 Years**

(21) Appl. No.: **29/376,044**

(22) Filed: **Sep. 30, 2010**

(51) **LOC (9) Cl.** ..... **26-02**

(52) **U.S. Cl.** ..... **D26/49**

(58) **Field of Classification Search** ..... D26/37,  
D26/46, 49, 38; 362/157, 158, 183, 184,  
362/194-196, 202-208

See application file for complete search history.

(56) **References Cited**

**U.S. PATENT DOCUMENTS**

D488,877	S *	4/2004	Shin	.....	D26/49
7,278,764	B2 *	10/2007	Kim	.....	362/382
D577,844	S *	9/2008	Shiu	.....	D26/49
D586,489	S *	2/2009	Shiu	.....	D26/49
D599,928	S *	9/2009	Shiu	.....	D26/49
7,604,371	B2 *	10/2009	Bushee et al.	.....	362/206
7,686,472	B1 *	3/2010	Huang	.....	362/202

D621,538	S *	8/2010	Bushee	.....	D26/49
D630,784	S *	1/2011	Robinson et al.	.....	D26/49
2010/0315805	A1 *	12/2010	Dongpan	.....	362/157

**OTHER PUBLICATIONS**

U.S. Appl. No. 29/376,046, filed Sep. 30, 2010, Nguyen et al.

\* cited by examiner

*Primary Examiner* — Ian Simmons

*Assistant Examiner* — Carissa C Fitts

(74) *Attorney, Agent, or Firm* — Haynes and Boone, LLP

(57) **CLAIM**

The ornamental design for a lighting device, as shown and described.

**DESCRIPTION**

FIG. 1 is a front perspective view of a lighting device showing our new design;

FIG. 2 is a rear perspective view thereof;

FIG. 3 is a top plan view thereof.

FIG. 4 is a bottom plan view thereof;

FIG. 5 is a right side elevational view thereof;

FIG. 6 is a left side elevational view thereof;

FIG. 7 is a front side elevational view thereof; and,

FIG. 8 is a rear side elevational view thereof.

The dashed lines in FIGS. 1-8 are shown for illustrative purposes and form no part of the claimed design.

**1 Claim, 7 Drawing Sheets**

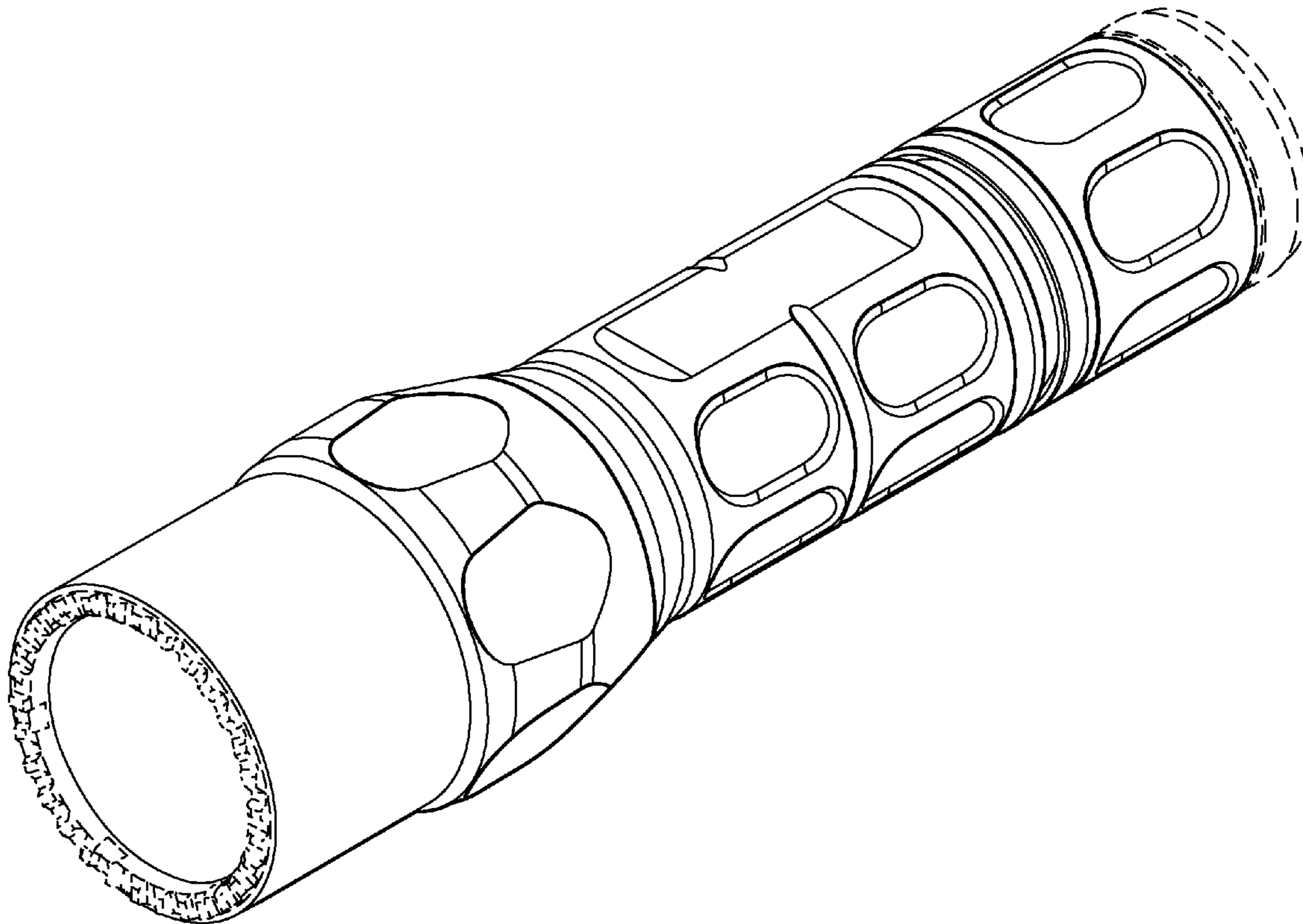

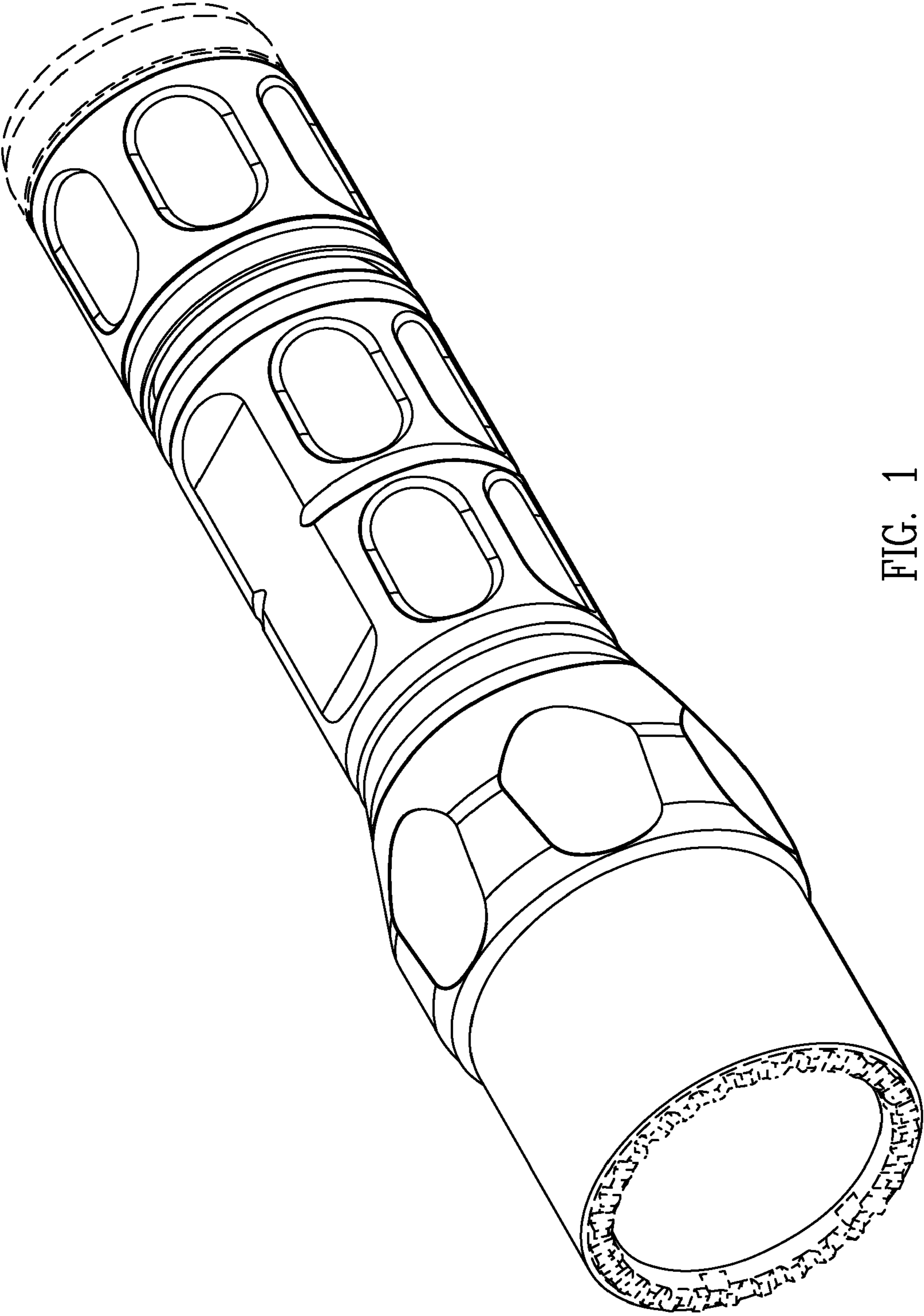

FIG. 1

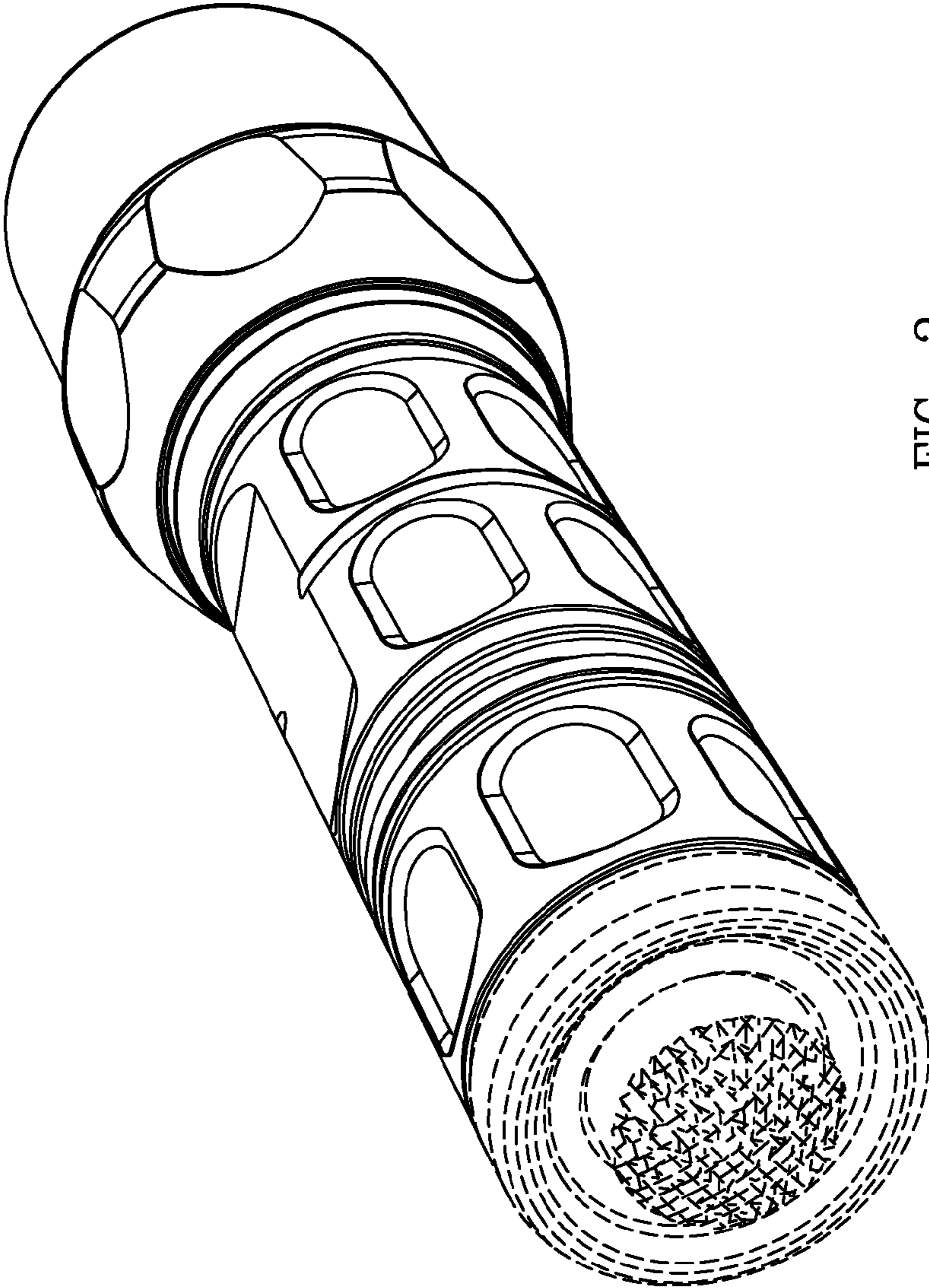

FIG. 2

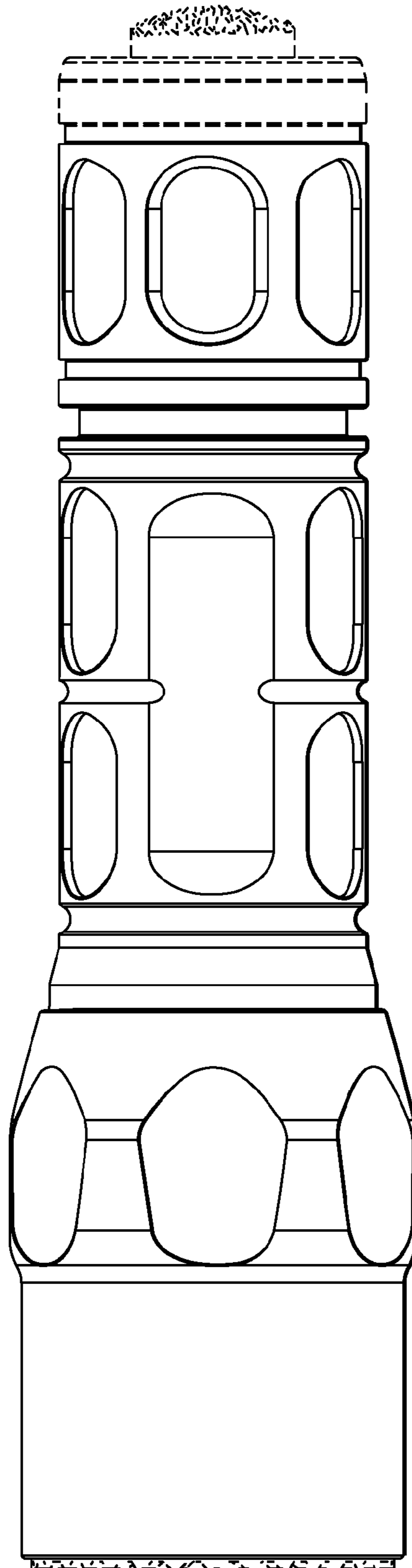

FIG. 3

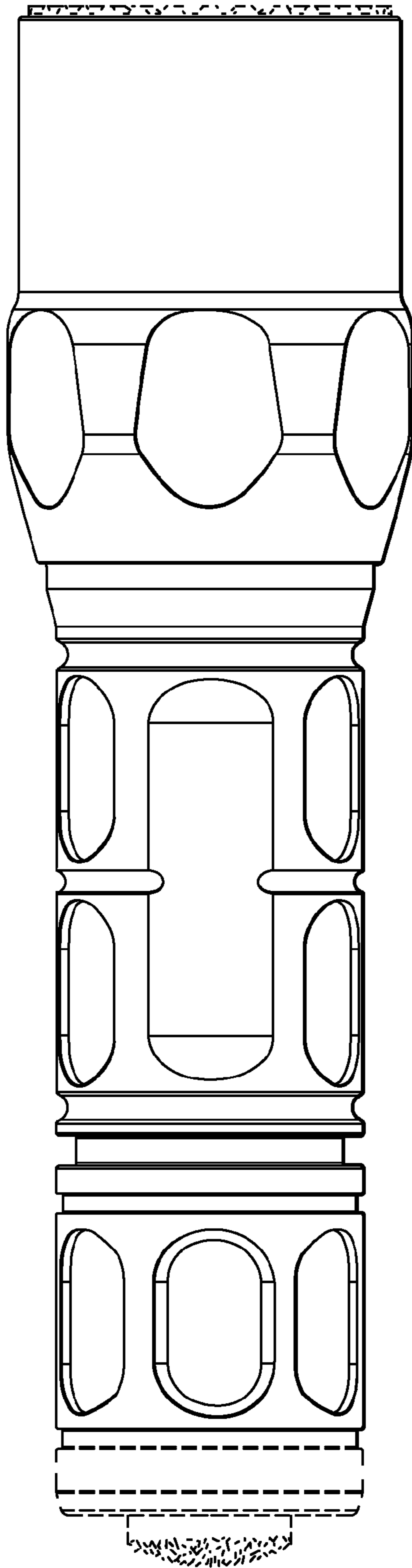

FIG. 4



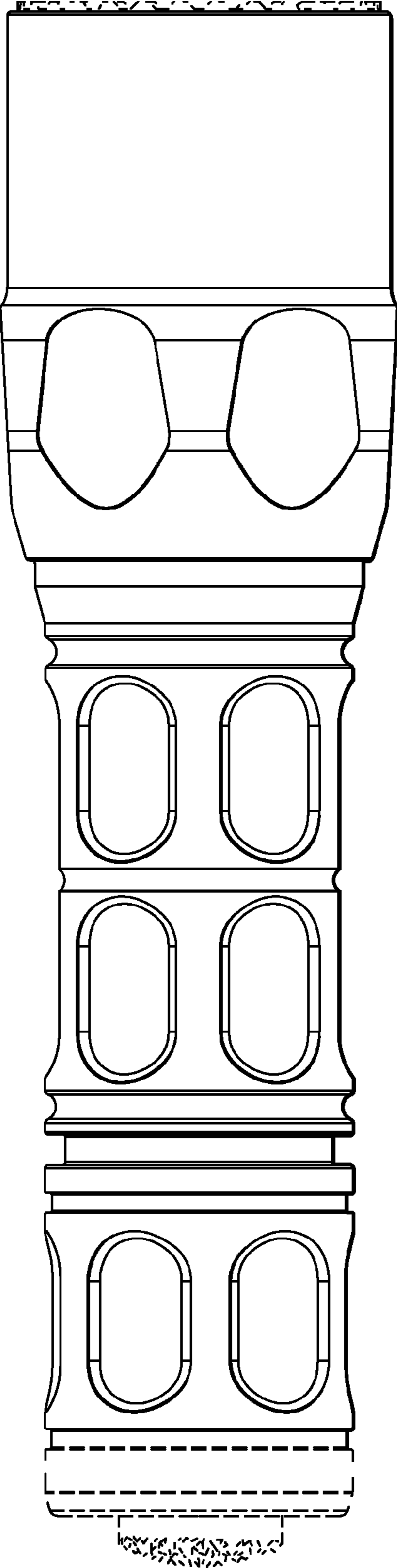

FIG. 5

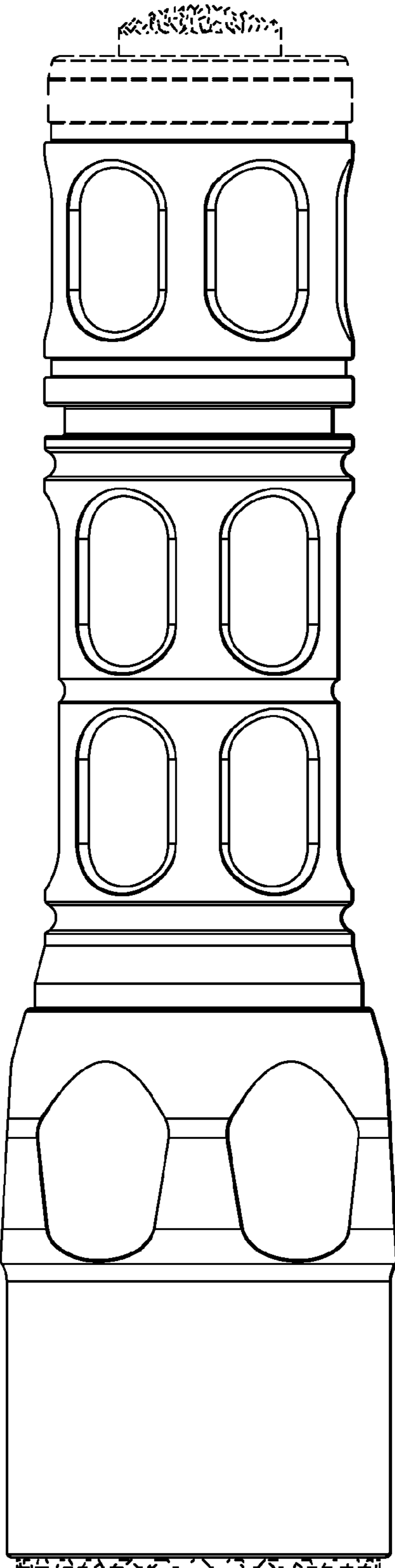

FIG. 6

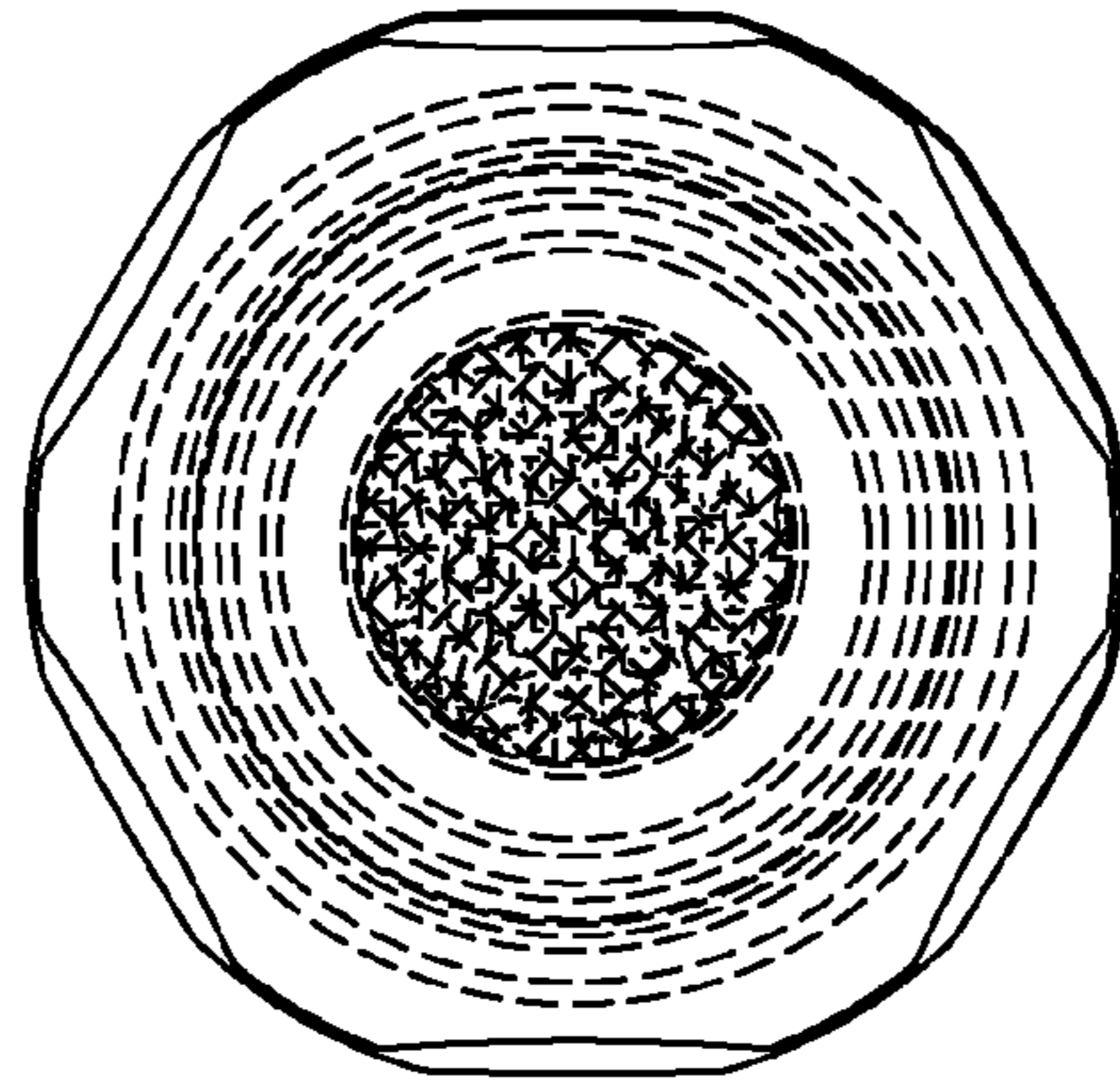

FIG. 8

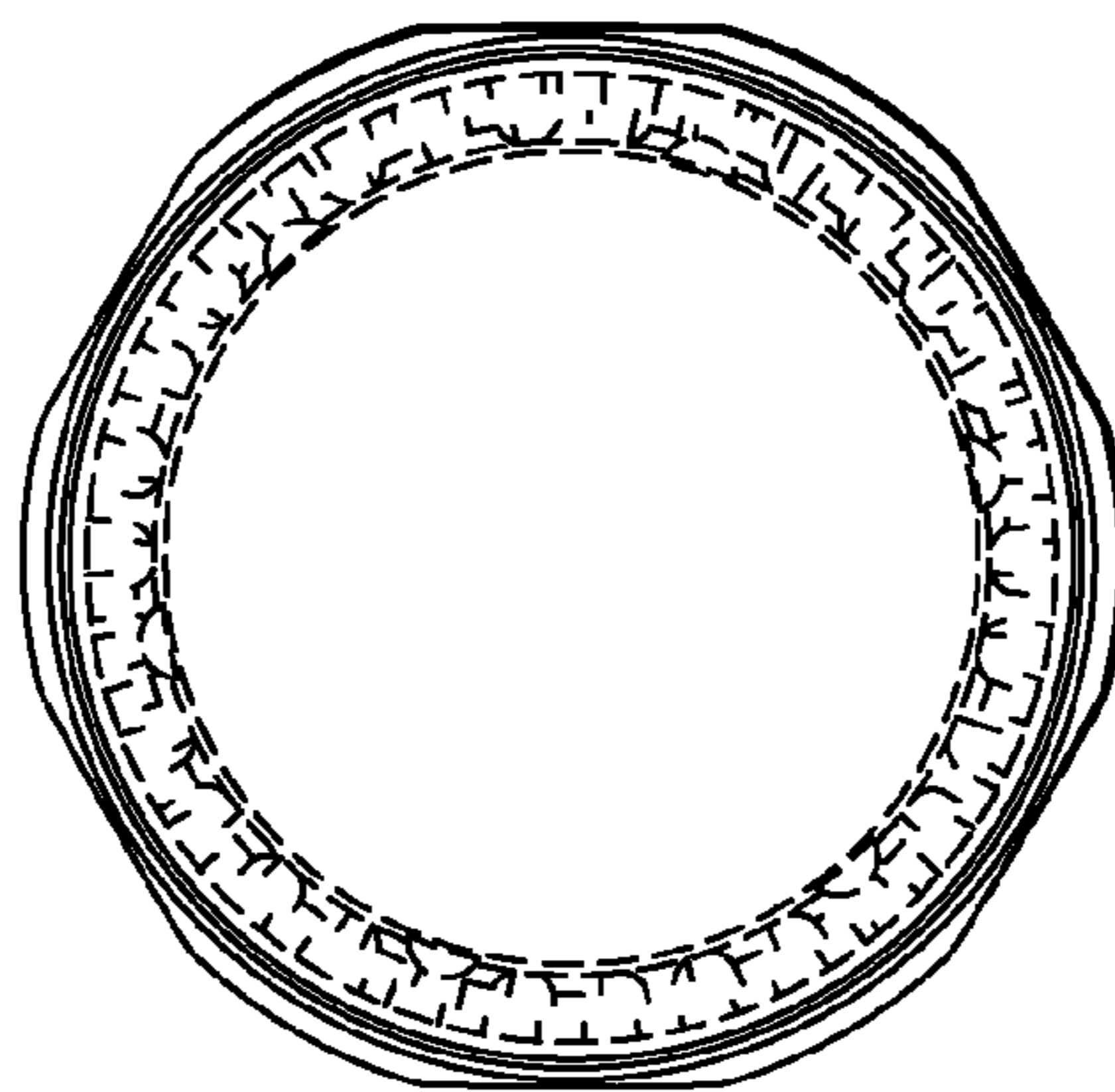

FIG. 7