



US00D639397S

(12) **United States Design Patent**
Fritz

(10) **Patent No.:** **US D639,397 S**

(45) **Date of Patent:** **** Jun. 7, 2011**

(54) **FAUCET HUB**

D610,235 S * 2/2010 Kwok D23/238

* cited by examiner

(75) Inventor: **Seth Fritz**, Carmel, IN (US)

Primary Examiner — Robert A Delehanty

(73) Assignee: **Masco Corporation of Indiana**,
Indianapolis, IN (US)

(74) *Attorney, Agent, or Firm* — Edgar A. Zarins; Nirav D. Parikh

(**) Term: **14 Years**

(57) **CLAIM**

(21) Appl. No.: **29/379,607**

The ornamental design for a faucet hub, as shown and described.

(22) Filed: **Nov. 22, 2010**

(51) **LOC (9) Cl.** **23-01**

(52) **U.S. Cl.** **D23/255**

(58) **Field of Classification Search** D23/238,
D23/241–242, 255, 257, 249; 4/675–678;
137/801

See application file for complete search history.

DESCRIPTION

FIG. 1 is a first perspective view of a faucet hub showing my new design;
FIG. 2 is a second perspective view thereof;
FIG. 3 is a front elevational view thereof;
FIG. 4 is a rear view thereof;
FIG. 5 is a left side view thereof;
FIG. 6 is a right side view thereof; and,
FIG. 7 is a top plan view thereof.

(56) **References Cited**

U.S. PATENT DOCUMENTS

D526,049 S * 8/2006 Lord D23/249
D593,185 S * 5/2009 Williams D23/238

1 Claim, 7 Drawing Sheets

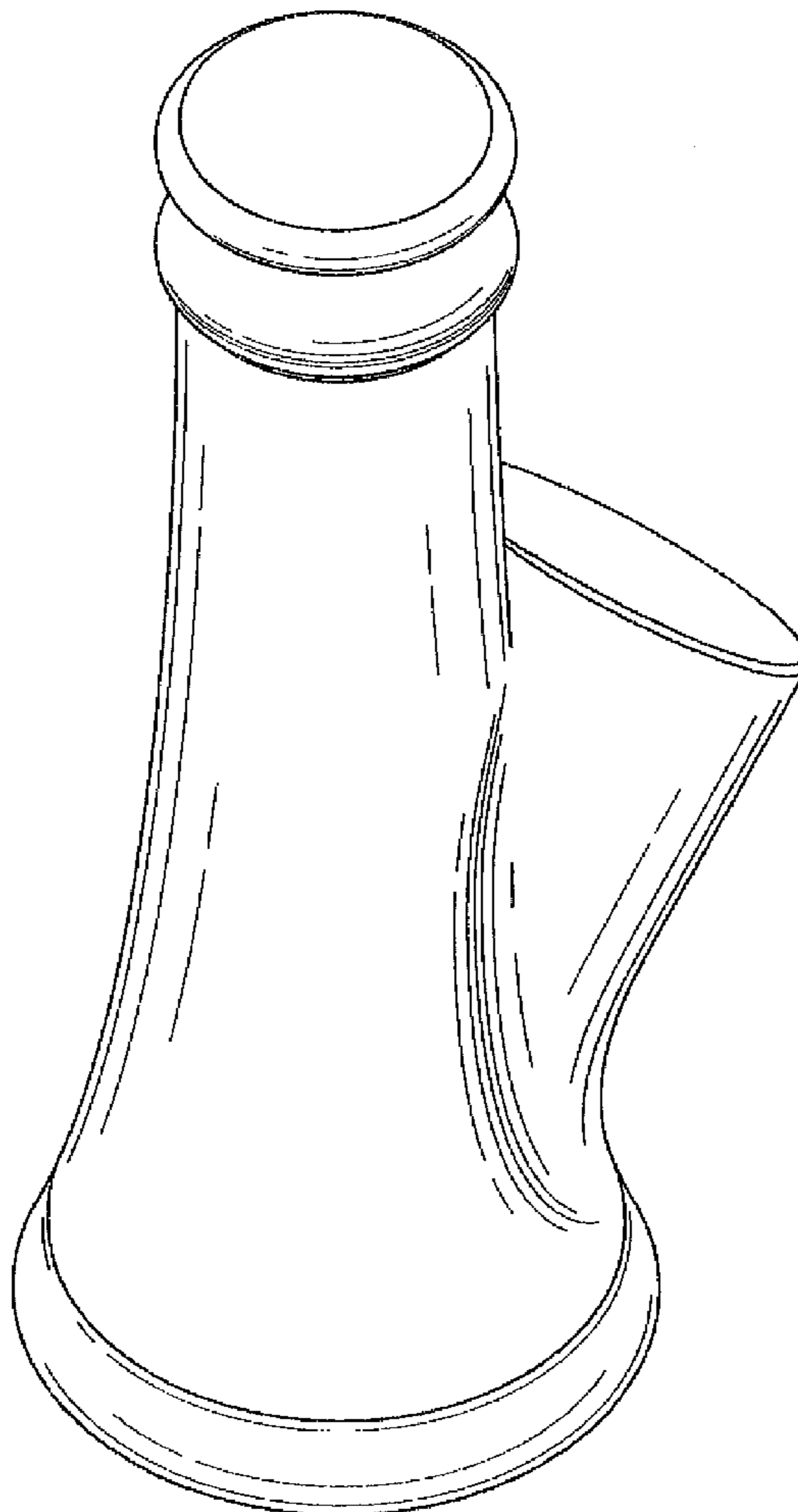

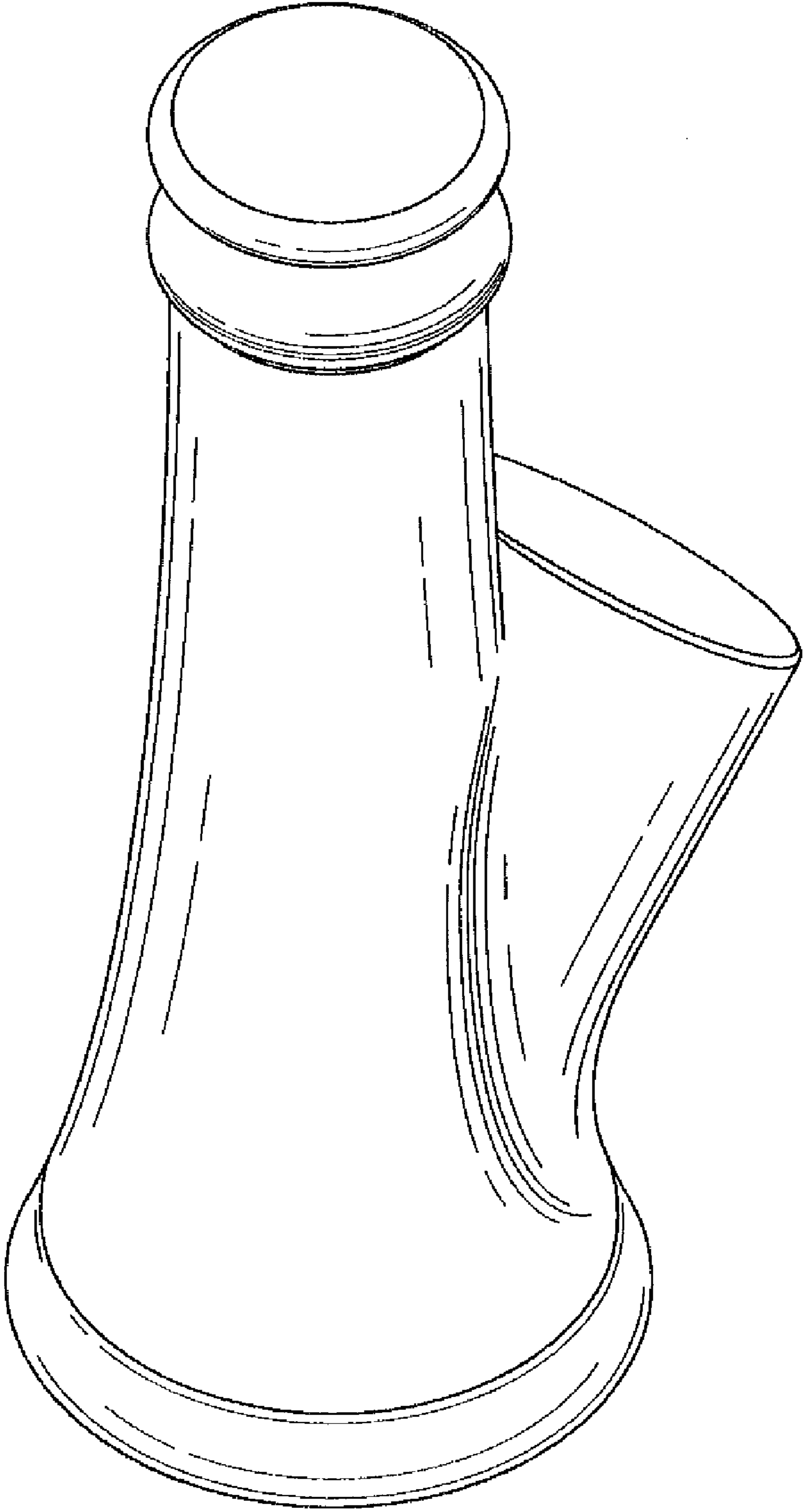

FIG. 1

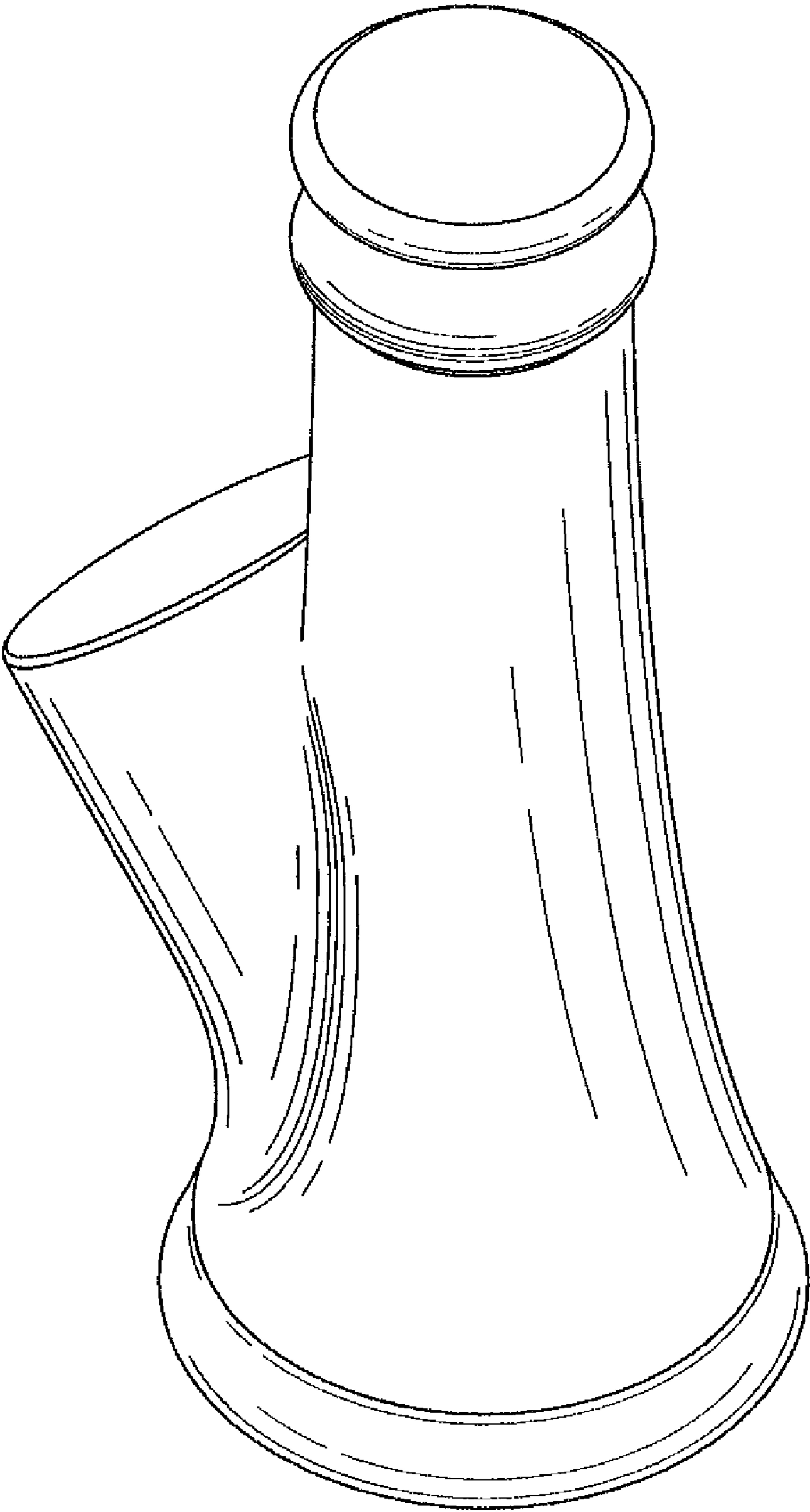

FIG. 2

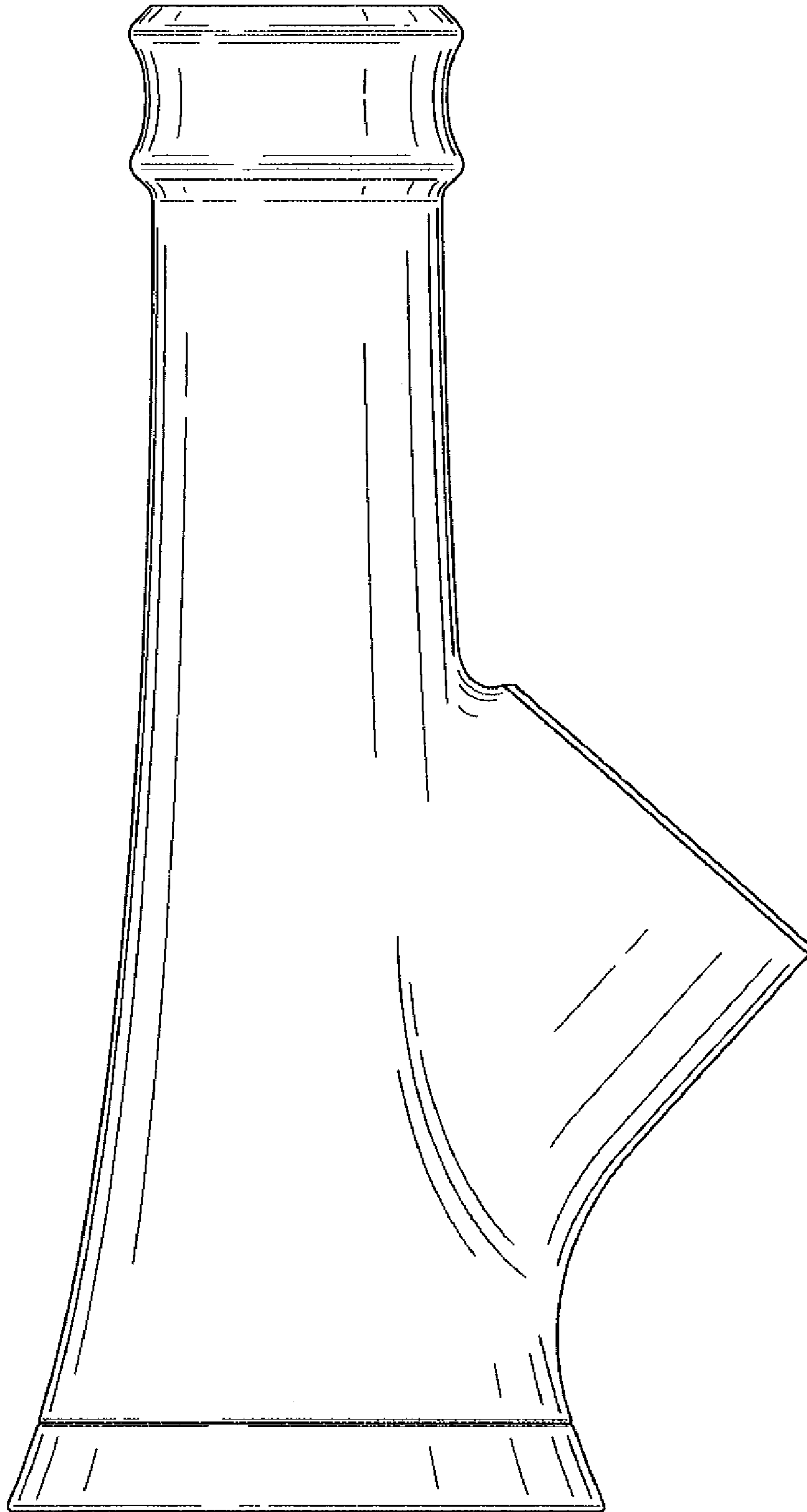

FIG. 3

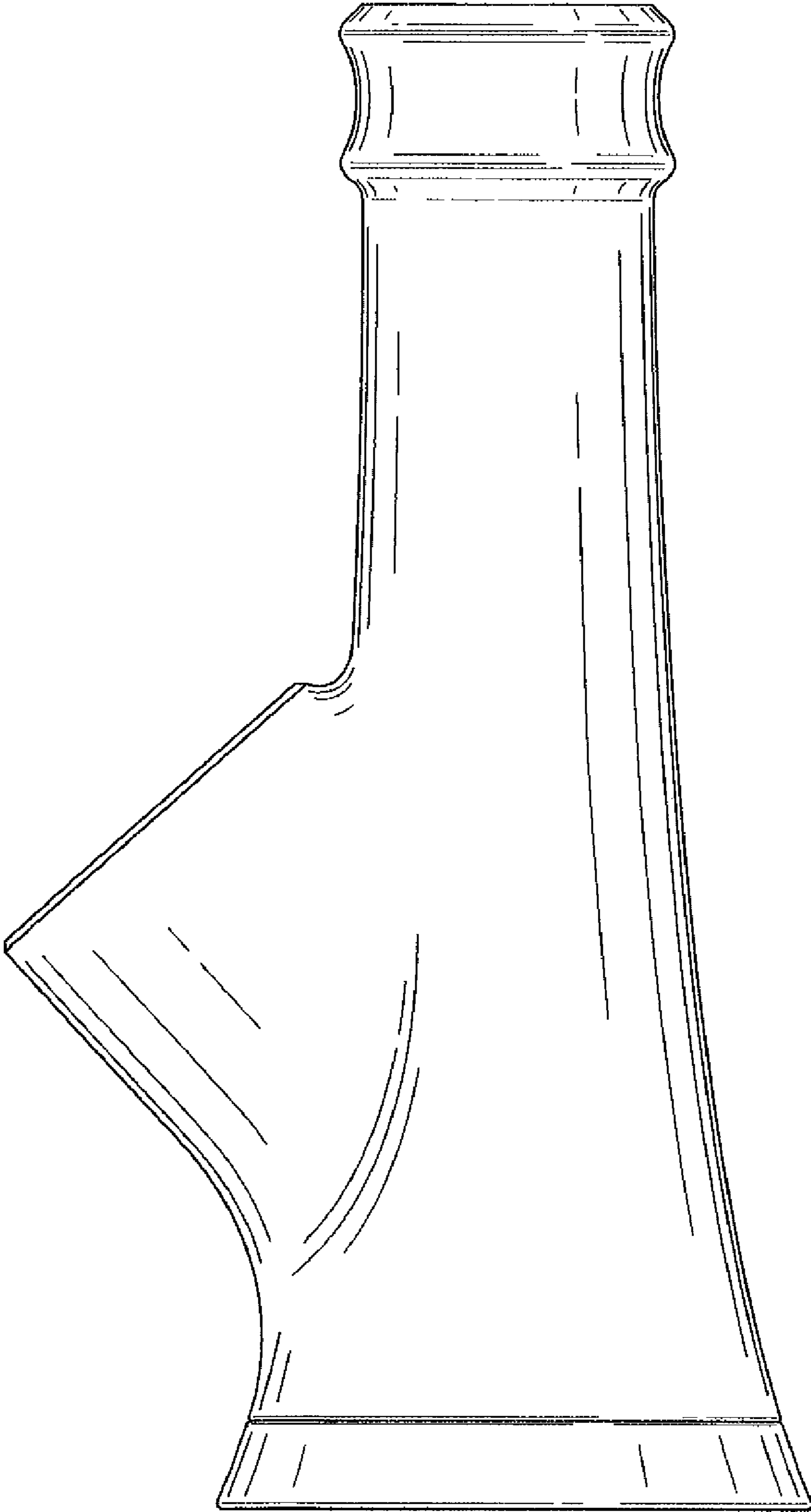

FIG. 4

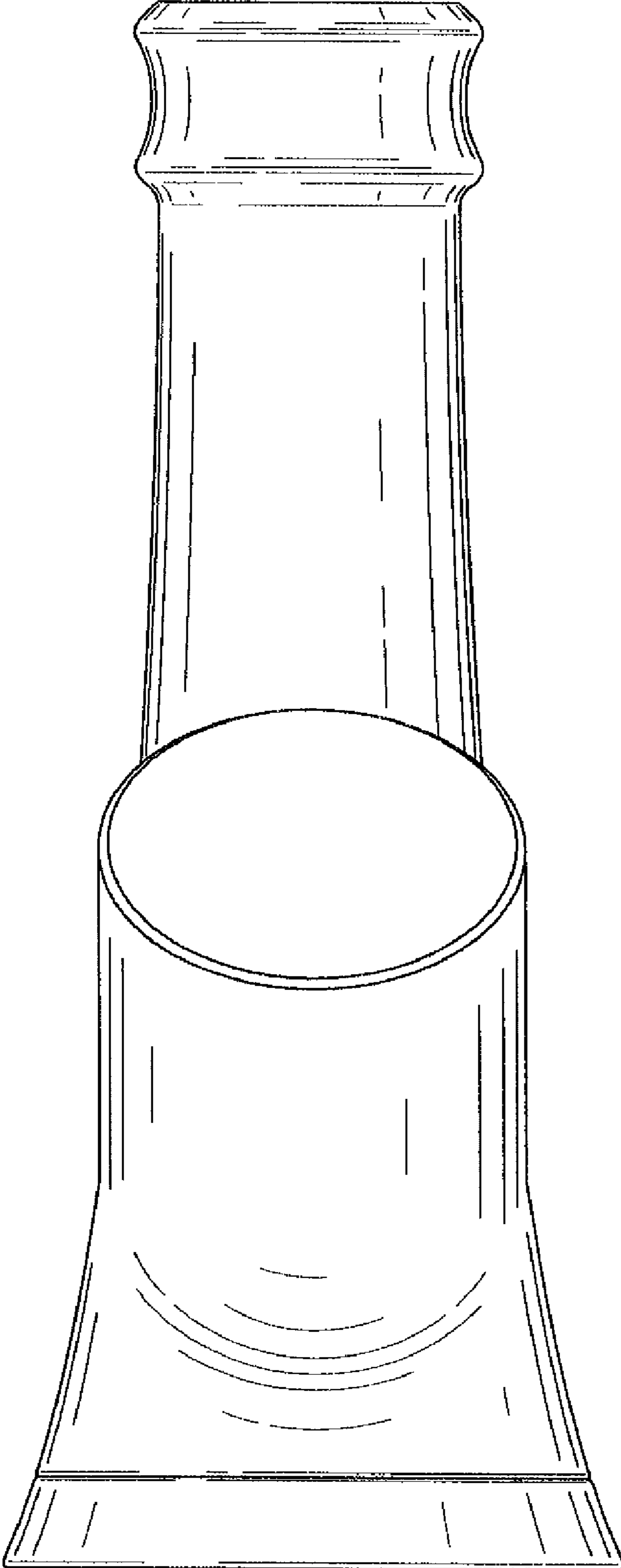

FIG. 5

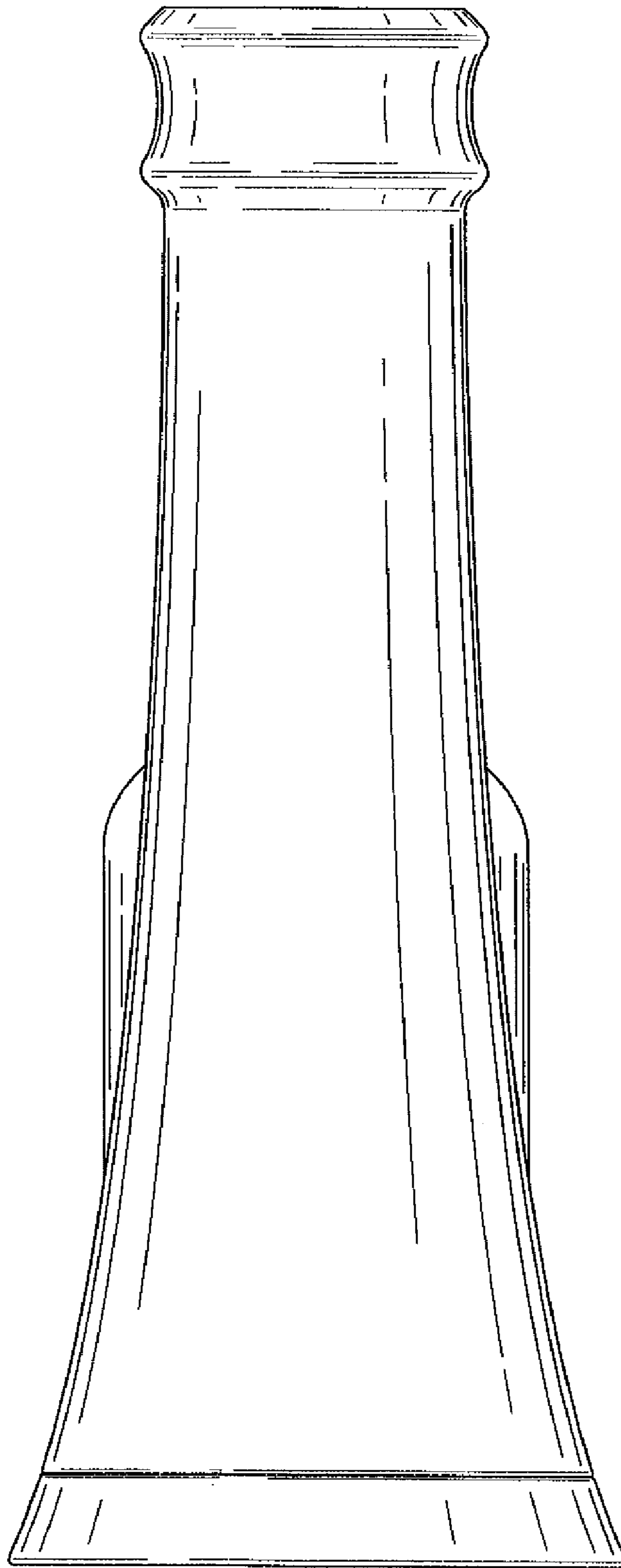

FIG. 6

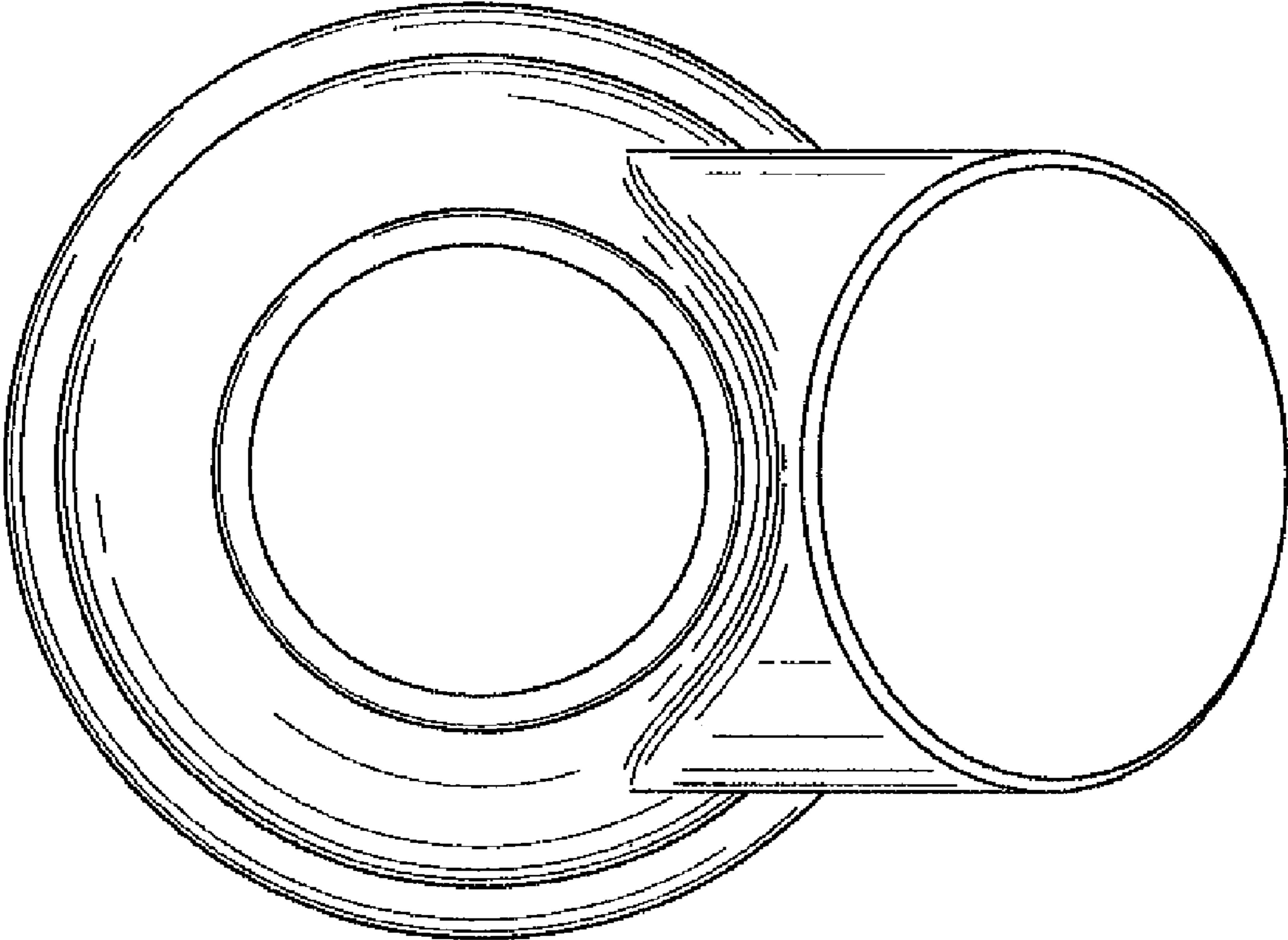

FIG. 7