



US00D639315S

(12) **United States Design Patent**
Yang et al.

(10) **Patent No.:** **US D639,315 S**
(45) **Date of Patent:** **** Jun. 7, 2011**

(54) **REFRIGERATOR**

(75) Inventors: **Yun Ho Yang**, Seoul (KR); **Sang Woon Jeon**, Kyunggi-do (KR)

(73) Assignee: **Samsung Electronics Co., Ltd.**, Suwon (KR)

(**) Term: **14 Years**

(21) Appl. No.: **29/377,150**

(22) Filed: **Oct. 18, 2010**

(51) **LOC (9) Cl.** **15-07**

(52) **U.S. Cl.** **D15/85**

(58) **Field of Classification Search** D15/79,
D15/81, 85, 88; 62/3.6-3.64, 245-255; 312/116,
312/236, 400-408

See application file for complete search history.

(56) **References Cited**

U.S. PATENT DOCUMENTS

D518,832 S * 4/2006 Park et al. D15/85
D568,343 S * 5/2008 Suh et al. D15/85

D578,556 S * 10/2008 Choi D15/85
D578,558 S * 10/2008 Choi D15/85
D620,506 S * 7/2010 Seo et al. D15/85
D625,343 S * 10/2010 Seo et al. D15/85
D630,655 S * 1/2011 Seo et al. D15/85

* cited by examiner

Primary Examiner — Shanda C Hill

(74) *Attorney, Agent, or Firm* — Ladas & Parry LLP

(57) **CLAIM**

The ornamental design for a refrigerator, as shown and described.

DESCRIPTION

FIG. 1 is a front/right-side/top perspective view of a refrigerator showing our new design;
FIG. 2 is a front-side elevational view thereof;
FIG. 3 is a rear-side elevational view thereof;
FIG. 4 is a left-side elevational view thereof;
FIG. 5 is a right-side elevational view thereof;
FIG. 6 is a top-side elevational view thereof; and,
FIG. 7 is a bottom-side elevational view thereof.

1 Claim, 6 Drawing Sheets

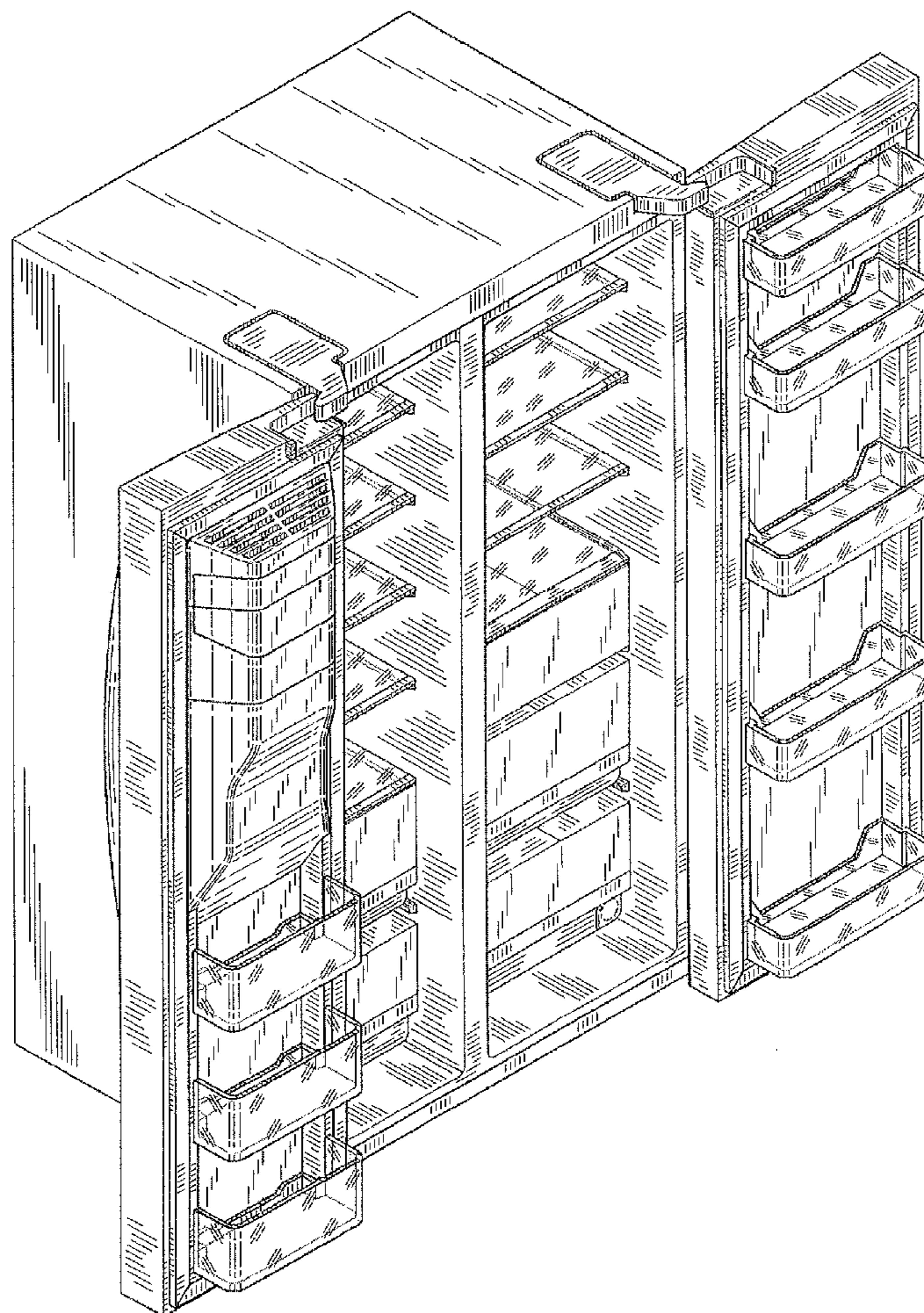

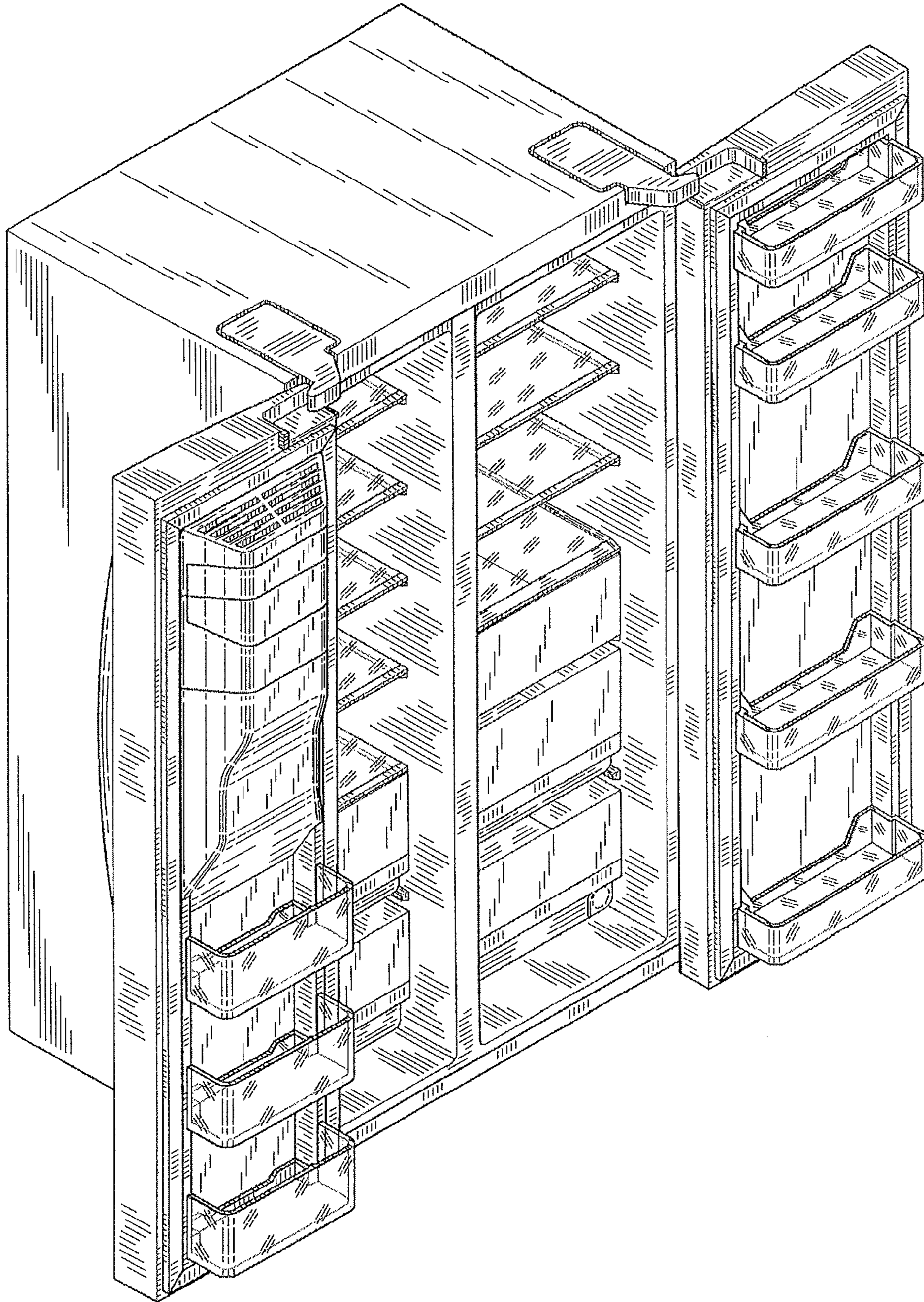

FIG. 1

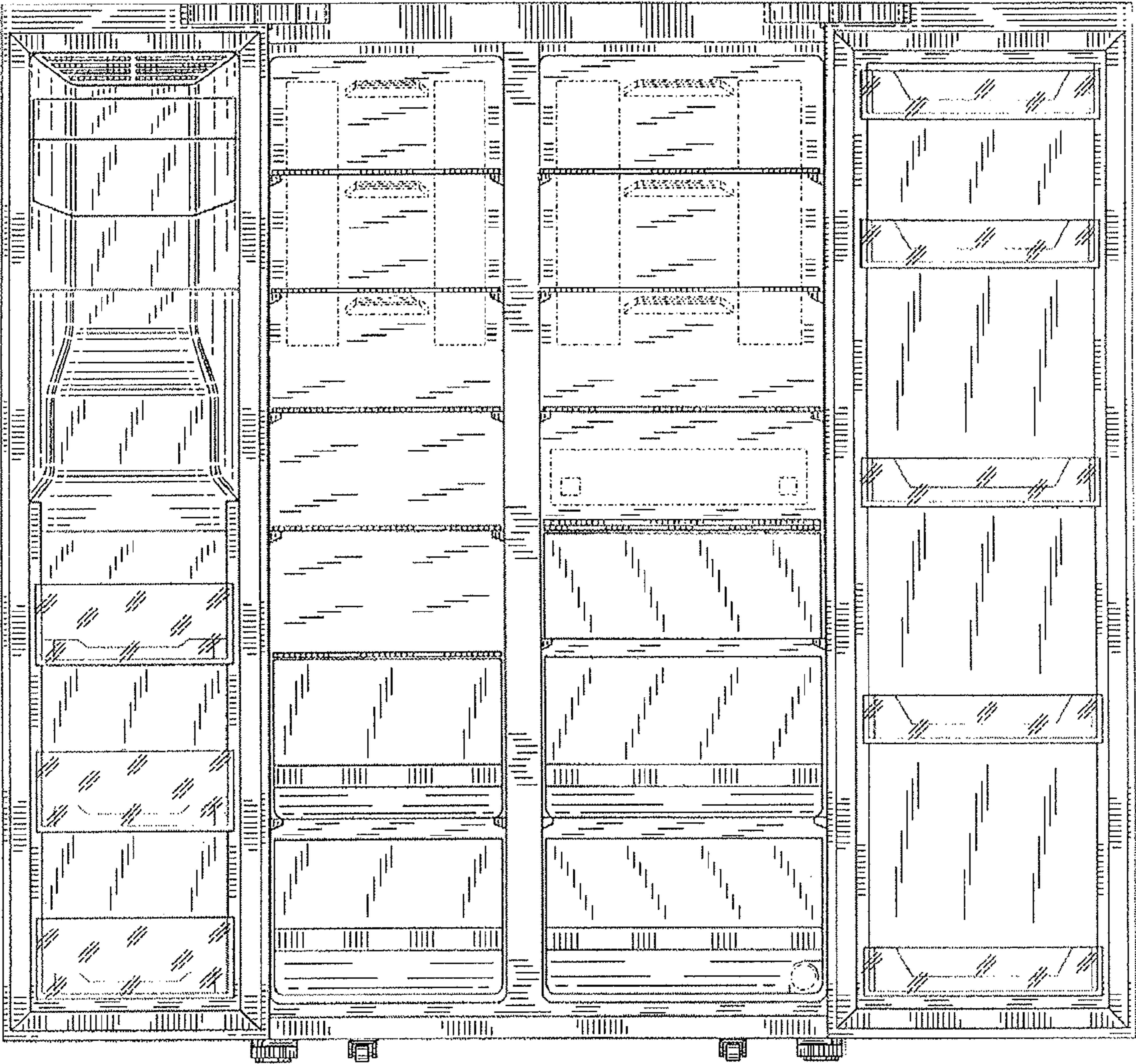

FIG. 2

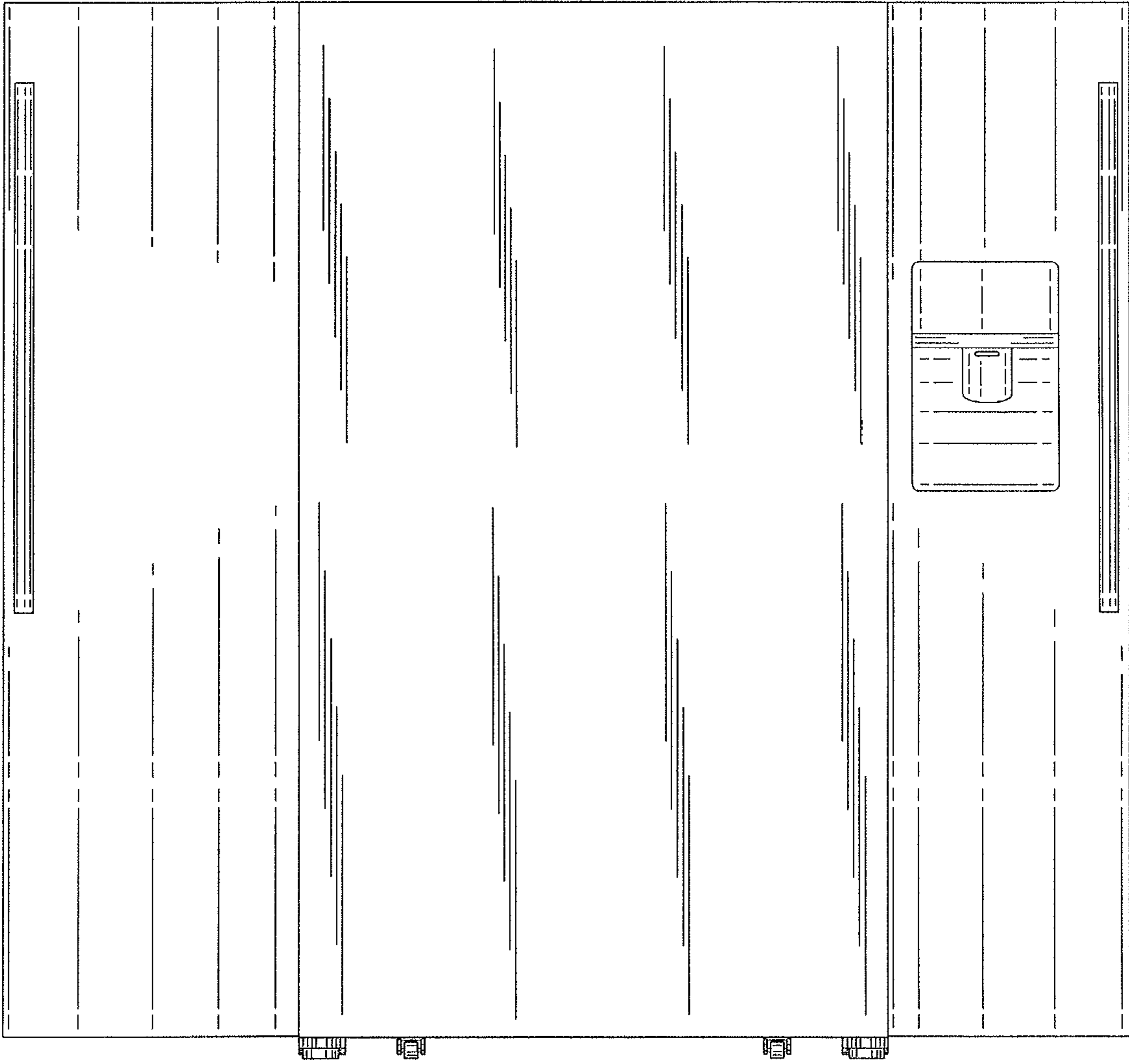

FIG. 3

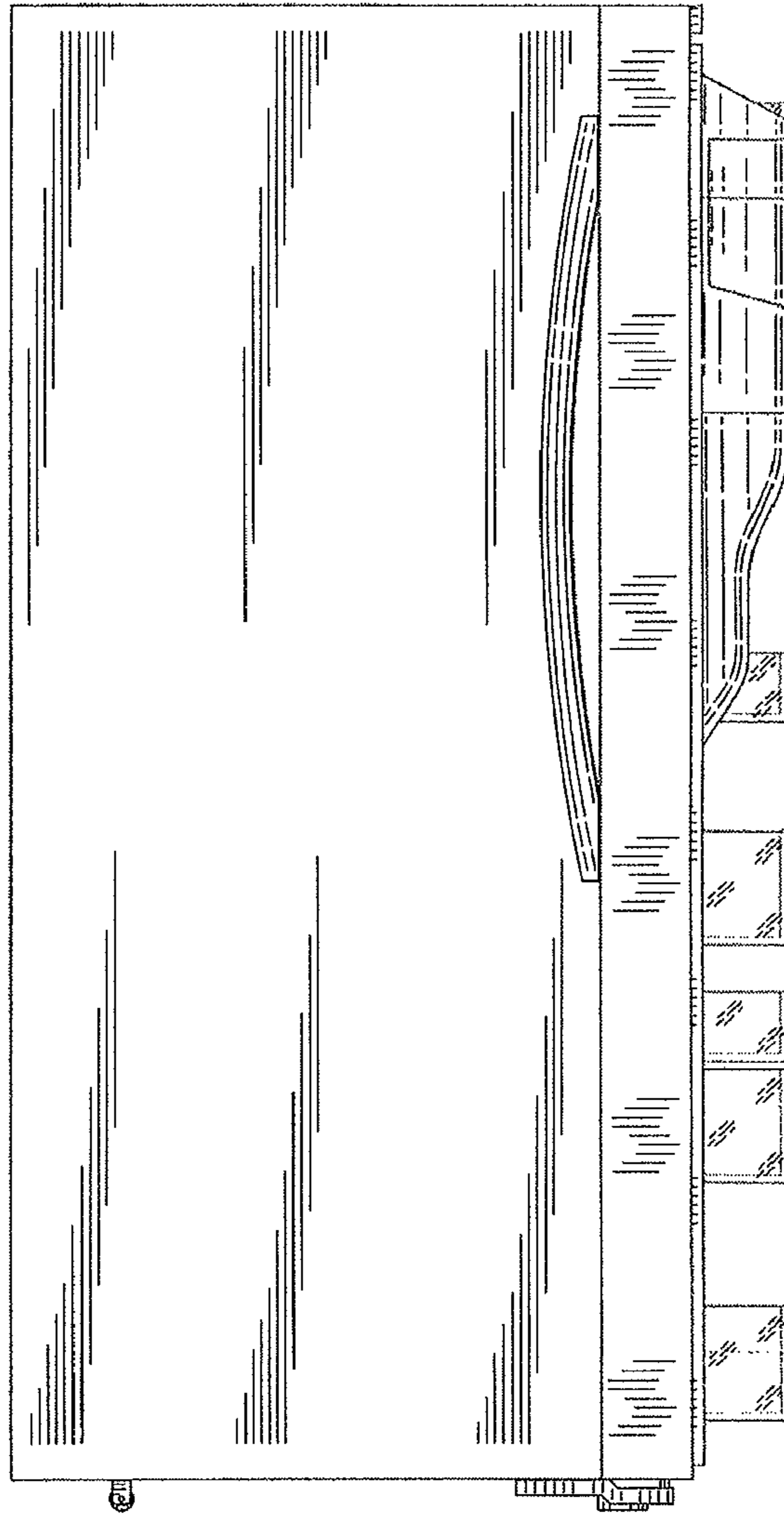

FIG. 4

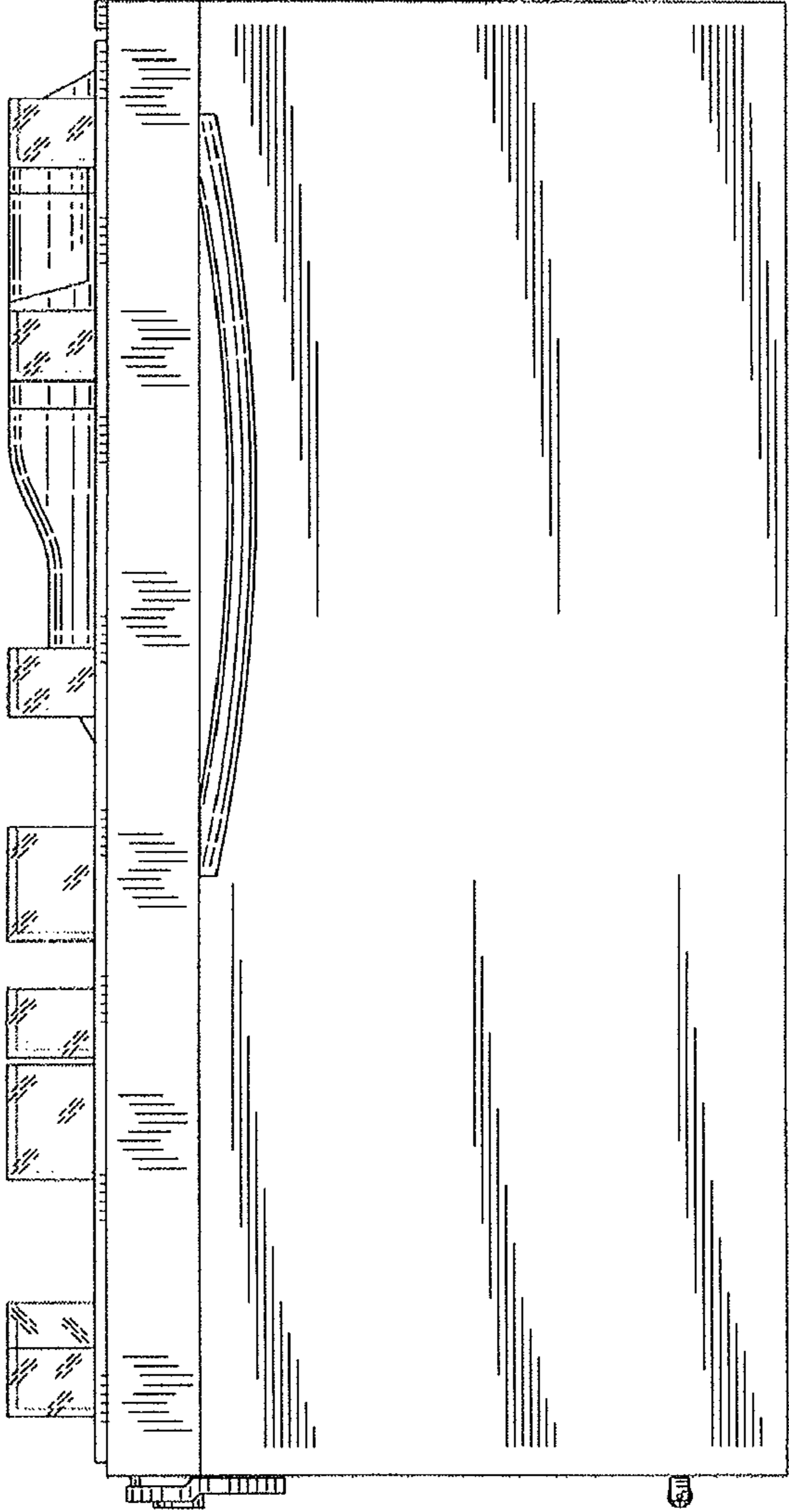

FIG. 5

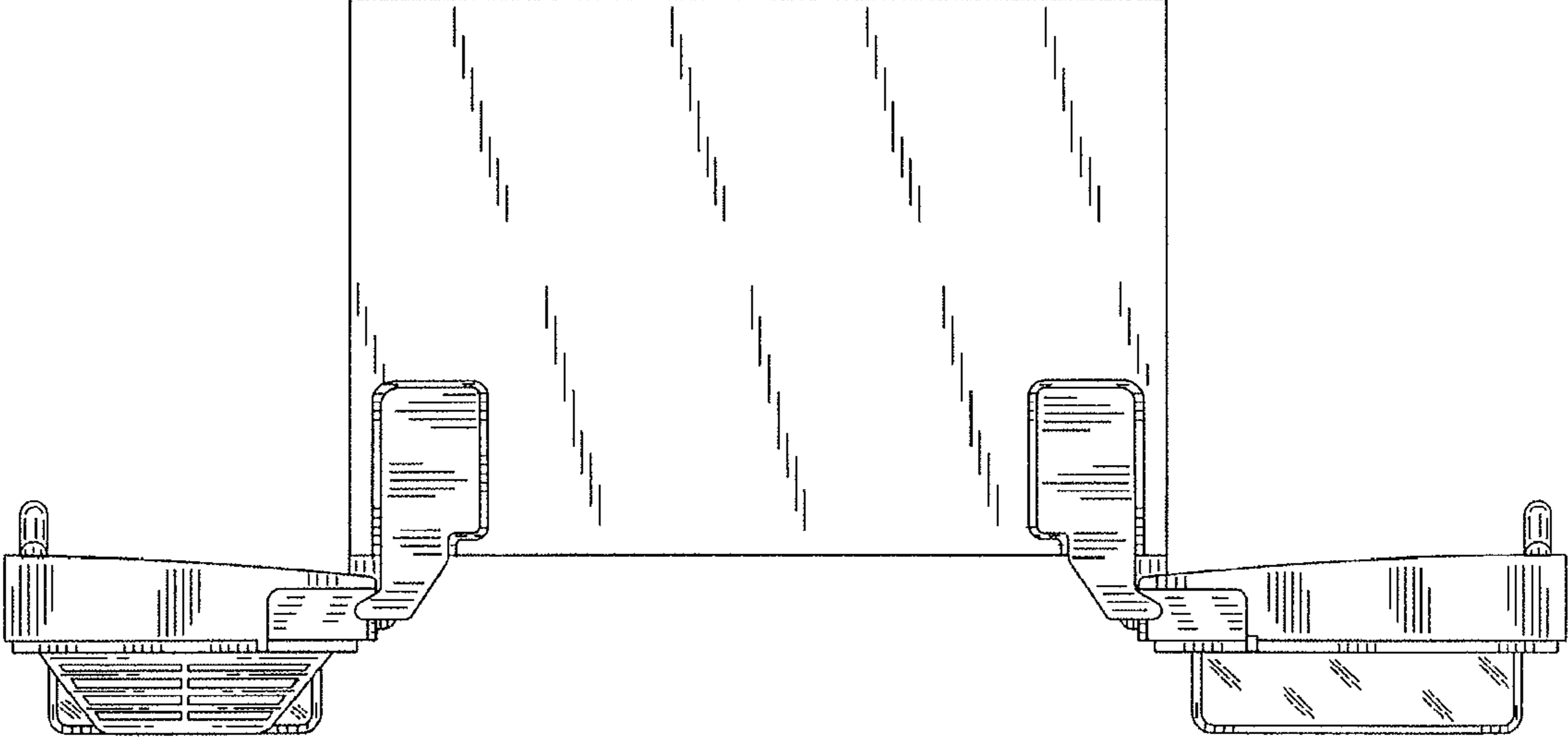

FIG. 6

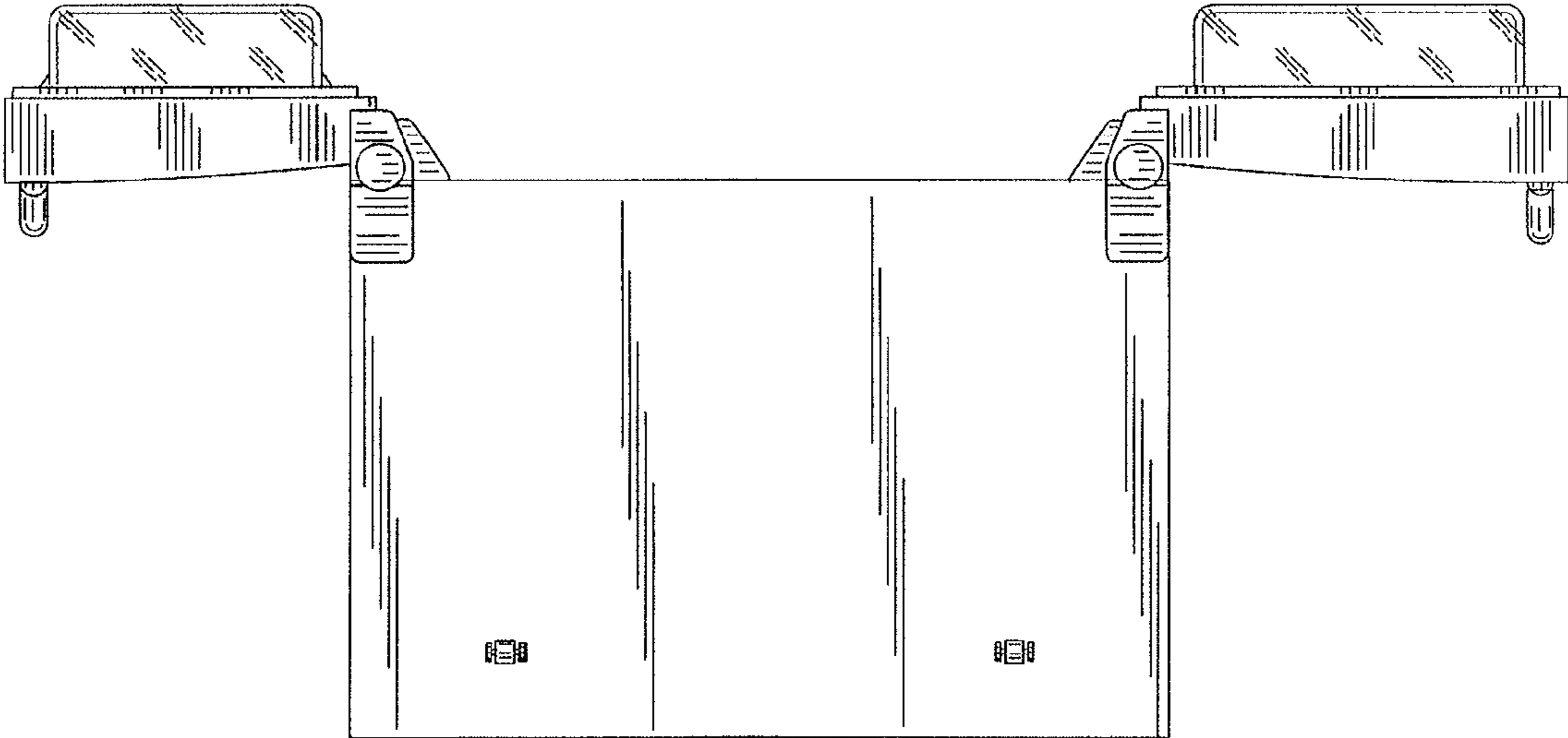

FIG. 7