



US00D639121S

(12) **United States Design Patent**
Jowett

(10) **Patent No.:** **US D639,121 S**
(45) **Date of Patent:** **** Jun. 7, 2011**

(54) **SANDWICH BREAD CRUST CUTTER**

(76) **Inventor:** **Kiersten Julia Jowett, Ashburton (AU)**

(**) **Term:** **14 Years**

(21) **Appl. No.:** **29/365,651**

(22) **Filed:** **Jul. 13, 2010**

(51) **LOC (9) Cl.** **07-03**

(52) **U.S. Cl.** **D7/673**

(58) **Field of Classification Search** D7/672-677;
249/117, 135; 30/303, 301, 305, 312, 315,
30/114, 124, 299, 130, 314, 316; 269/87.2,
269/295, 288; 425/276, 281, 290, 289, DIG. 1
See application file for complete search history.

(56) **References Cited**

U.S. PATENT DOCUMENTS

| | | | |
|---------------|--------|-------------------|---------|
| D154,318 S * | 6/1949 | Price et al. | D7/676 |
| D154,319 S * | 6/1949 | Price et al. | D7/676 |
| 2,754,587 A * | 7/1956 | Bylkas | 30/301 |
| 3,319,682 A * | 5/1967 | Hall | 269/288 |
| 4,245,973 A * | 1/1981 | Greaney | 425/276 |
| D567,037 S * | 4/2008 | Taylor | D7/672 |

| | | | |
|-------------------|--------|-------------------|--------|
| D597,800 S * | 8/2009 | Goode et al. | D7/675 |
| D597,801 S * | 8/2009 | Goode et al. | D7/675 |
| 2004/0187317 A1 * | 9/2004 | Wood | 30/315 |

FOREIGN PATENT DOCUMENTS

AU 316513AS 8/2007

* cited by examiner

Primary Examiner — Terry A Wallace

(74) *Attorney, Agent, or Firm* — Saul Ewing LLP; Theodore Naccarella

(57) **CLAIM**

The ornamental design for a sandwich bread crust cutter, as shown and described.

DESCRIPTION

FIG. 1 is a bottom view of the cutting pattern applied to a sandwich bread crust cutter showing my new design; FIG. 2. is a front elevation view thereof; FIG. 3. is an isometric view thereof; FIG. 4. is a top plan view thereof; FIG. 5. is a right side elevation view thereof; FIG. 6. is a left elevation view thereof; and, FIG. 7. is a rear elevation view thereof.

1 Claim, 3 Drawing Sheets

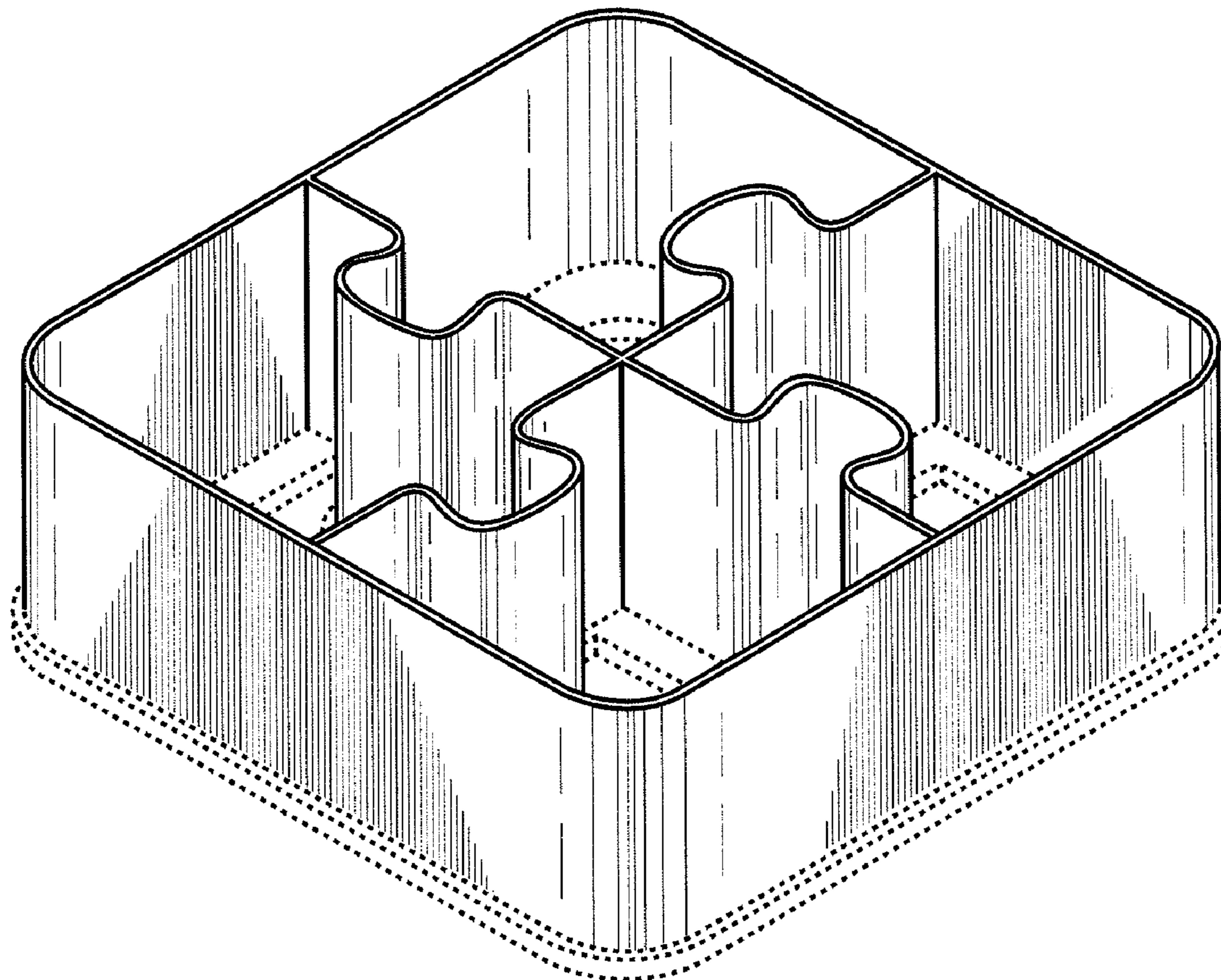

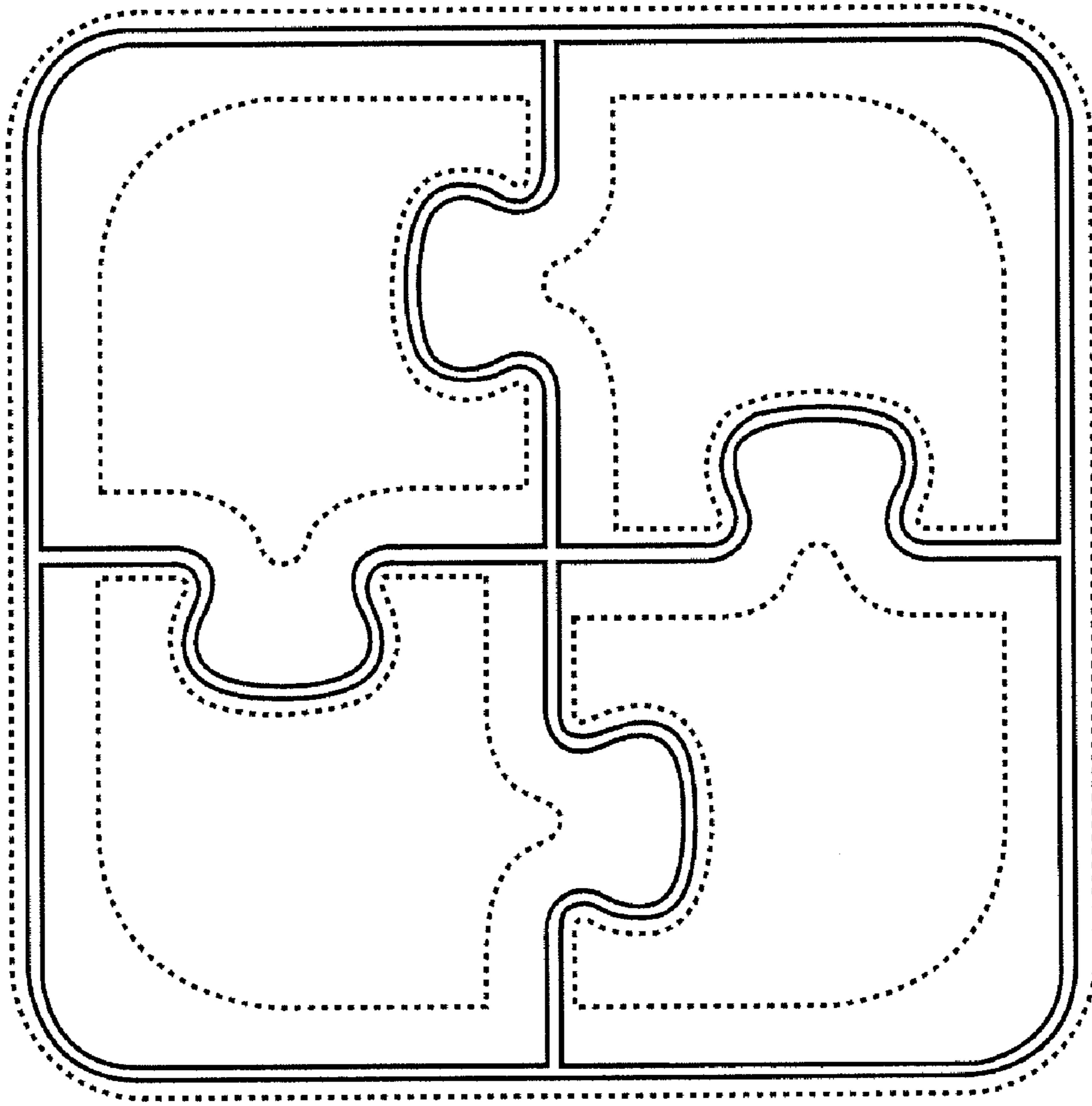

Figure 1

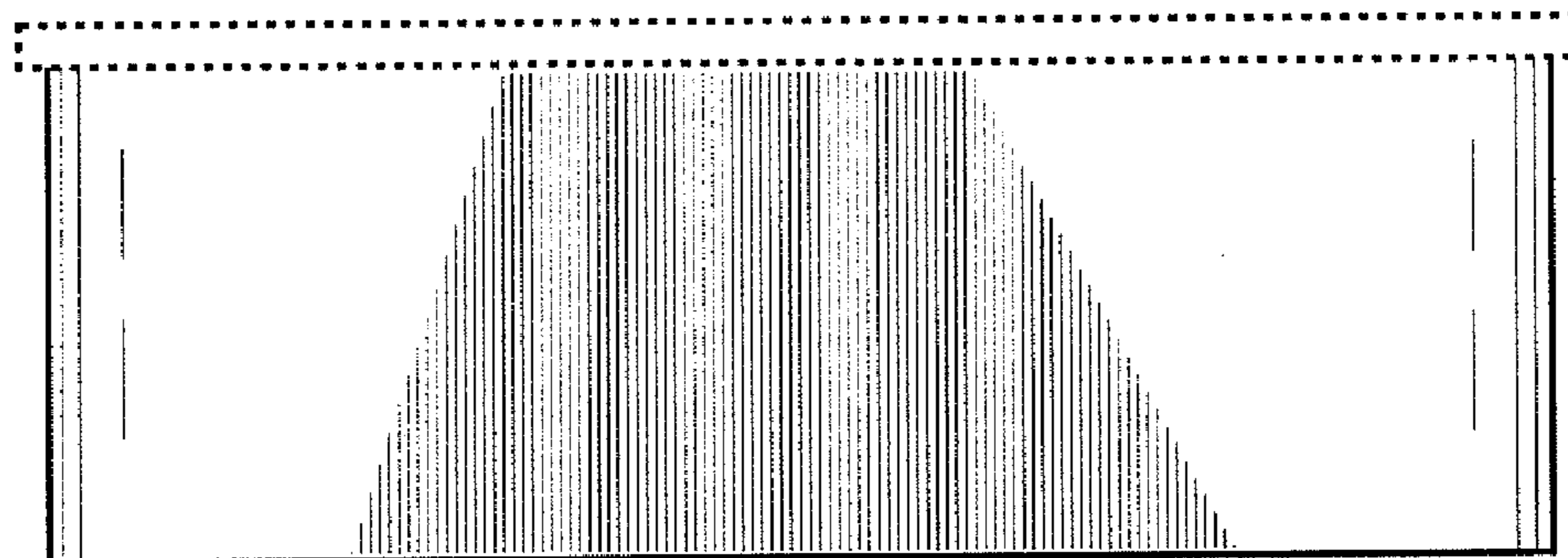

Figure 2

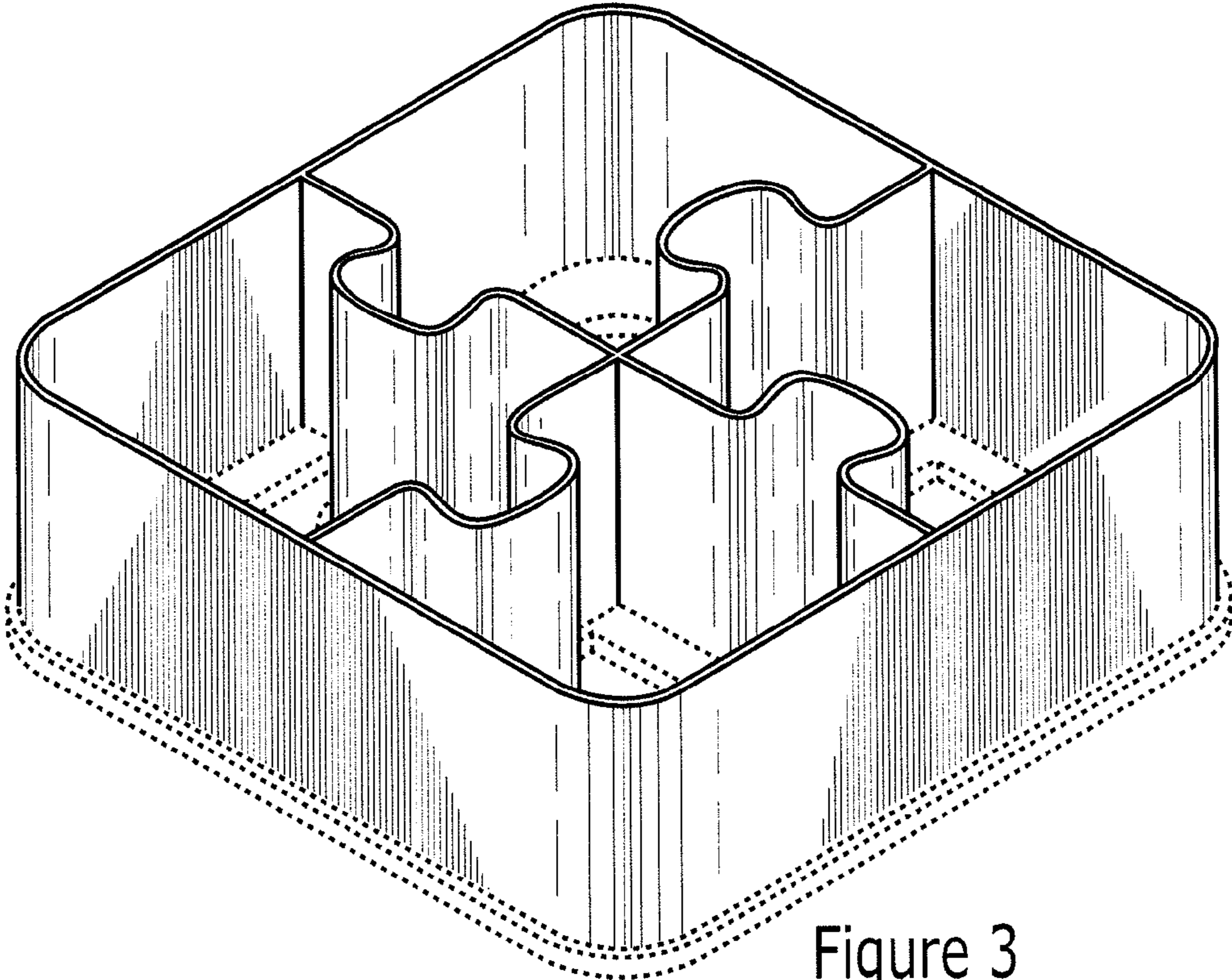

Figure 3

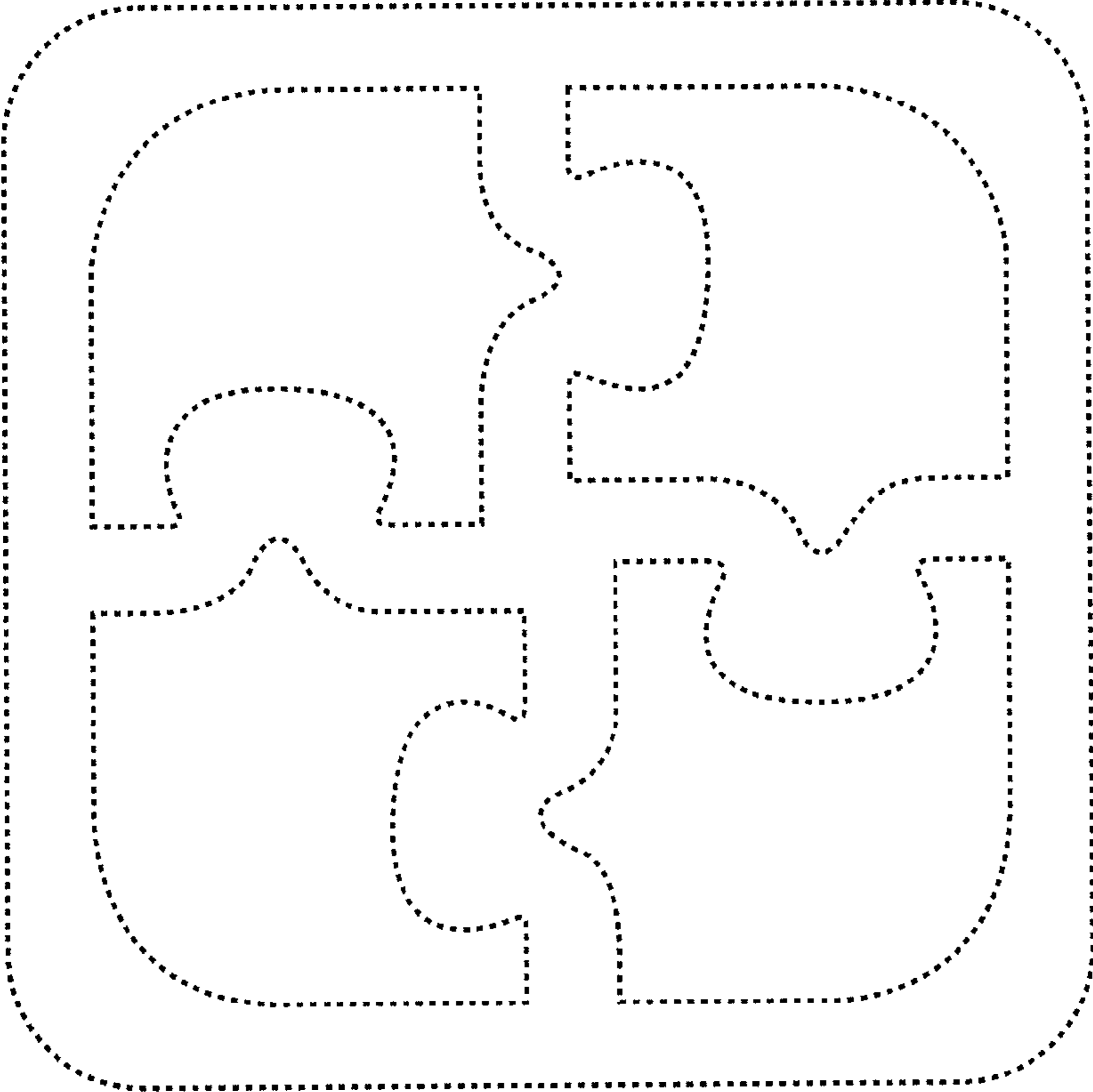

Figure 4

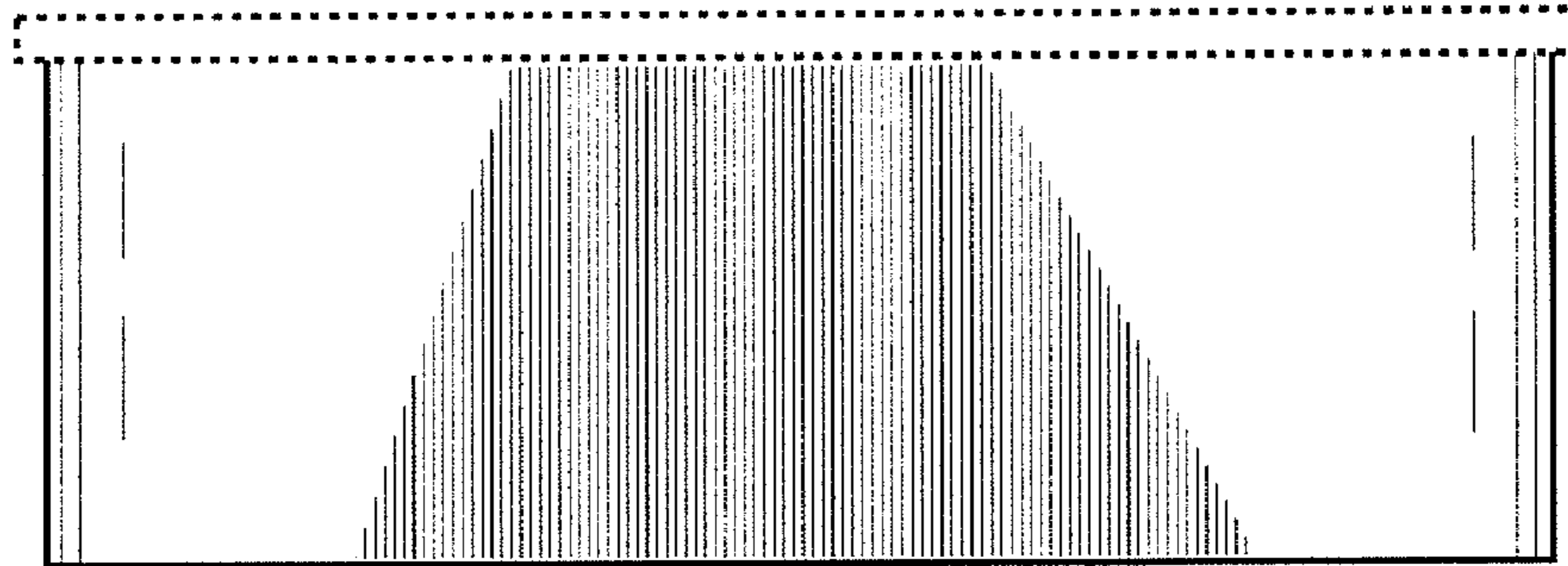

Figure 5

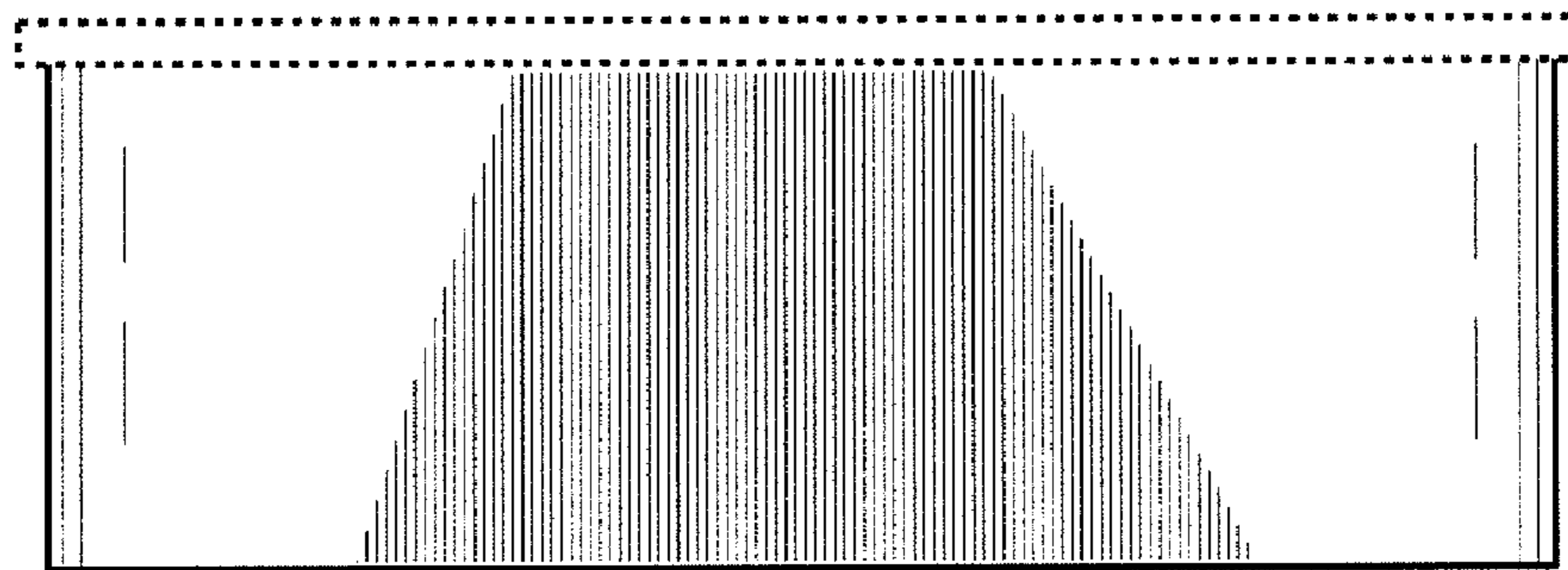

Figure 6

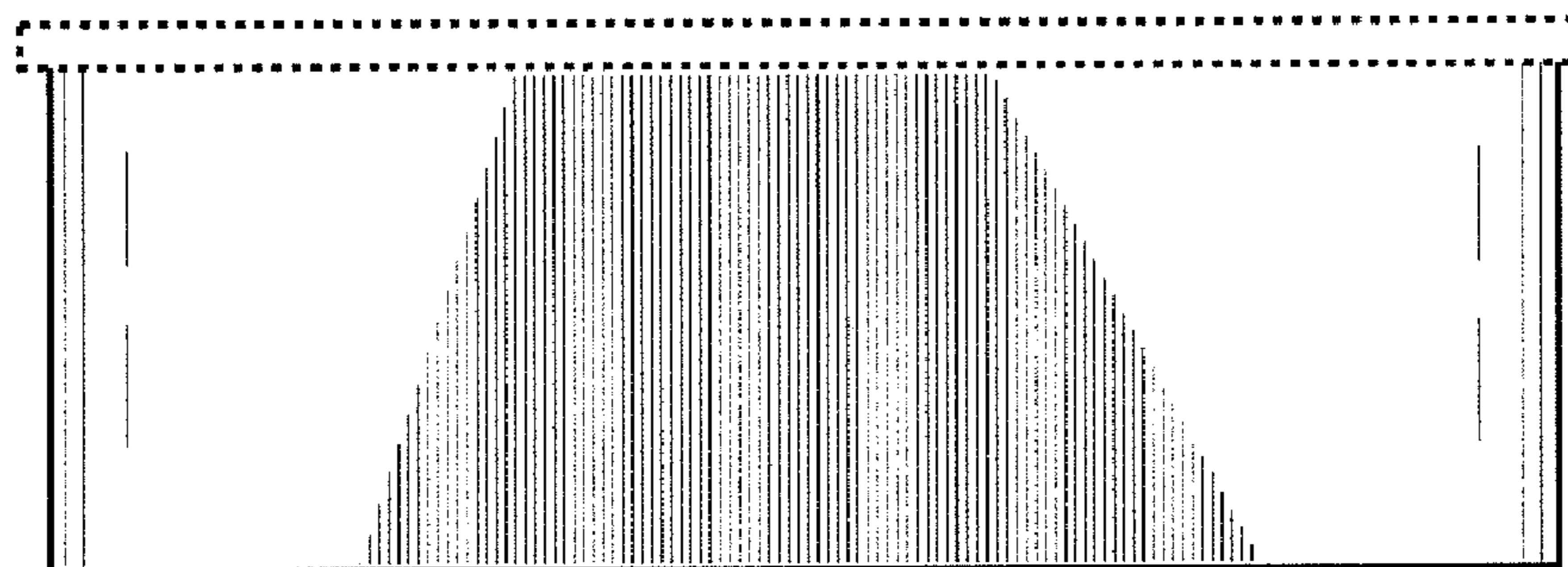

Figure 7