



US00D639022S

(12) **United States Design Patent**  
**Tatroe et al.**

(10) **Patent No.:** **US D639,022 S**  
(45) **Date of Patent:** **\*\* Jun. 7, 2011**

(54) **SCRUB**

(76) Inventors: **Stacey Dawn Tatroe**, Dallas, GA (US);  
**Jeffrey Bryan Tatroe**, Dallas, GA (US)

(\*\*) Term: **14 Years**

(21) Appl. No.: **29/364,791**

(22) Filed: **Jun. 28, 2010**

(51) **LOC (9) Cl.** ..... **02-02**

(52) **U.S. Cl.** ..... **D2/743; D2/841**

(58) **Field of Classification Search** ..... D2/700,  
D2/704, 712-715, 720, 728, 731-732, 736-737,  
D2/738-739, 742-743, 746, 747, 848, 840-841,  
D2/844; 2/69, 71, 76, 79, 113-114, 227,  
2/238, 401-404, 115

See application file for complete search history.

(56) **References Cited**

**U.S. PATENT DOCUMENTS**

4,737,995	A *	4/1988	Wiley	.....	2/114
4,987,610	A *	1/1991	Hunt	.....	D2/840
D364,493	S *	11/1995	Williams	.....	D2/714
D445,997	S *	8/2001	Robertson	.....	D2/743
D457,290	S *	5/2002	Thompson	.....	D2/743
D481,194	S *	10/2003	Berube	.....	D2/737
D483,172	S *	12/2003	Edwards et al.	.....	D2/743
7,418,741	B2 *	9/2008	Rogers	.....	2/114
D621,587	S *	8/2010	Tatroe et al.	.....	D2/743

**OTHER PUBLICATIONS**

Jasco Uniform Co., p. 14, item Nos. 668J and 8350J (date unknow).  
Edition No. 1207A.\*

Jasco Uniform Co., p. 29, item Nos. 75025 and 76025 (date unknow).  
Edition No. 1207A.\*

Jasco Uniform Co., p. 7, item Nos. 1010J and 5010J. Edition No.  
1107C.\*

Jasco Uniform Co., p. 10, item Nos. 2826J and 2830J. Edition No.  
1107C.\*

\* cited by examiner

*Primary Examiner* — Ian Simmons

*Assistant Examiner* — Wan Laymon

(74) *Attorney, Agent, or Firm* — Sinorica, LLC

(57) **CLAIM**

The ornamental design for a scrub, as shown and described.

**DESCRIPTION**

FIG. 1 is a front perspective view of scrub showing our design;

FIG. 2 is an exploded front elevational view thereof;

FIG. 3 is an exploded rear elevational view thereof;

FIG. 4 is an exploded left side elevational view thereof;

FIG. 5 is an exploded right side elevational view thereof;

FIG. 6 is an exploded bottom plan view thereof; and,

FIG. 7 is an exploded top plan view thereof.

The broken lines represent a human form in FIG. 1 form no part of the claimed design. The broken lines showing the broken back pocket and the letters “np” inside are included for the purpose of illustrating environmental structure and form no part of the claimed design. None of the broken lines form any part of the claimed design.

**1 Claim, 5 Drawing Sheets**

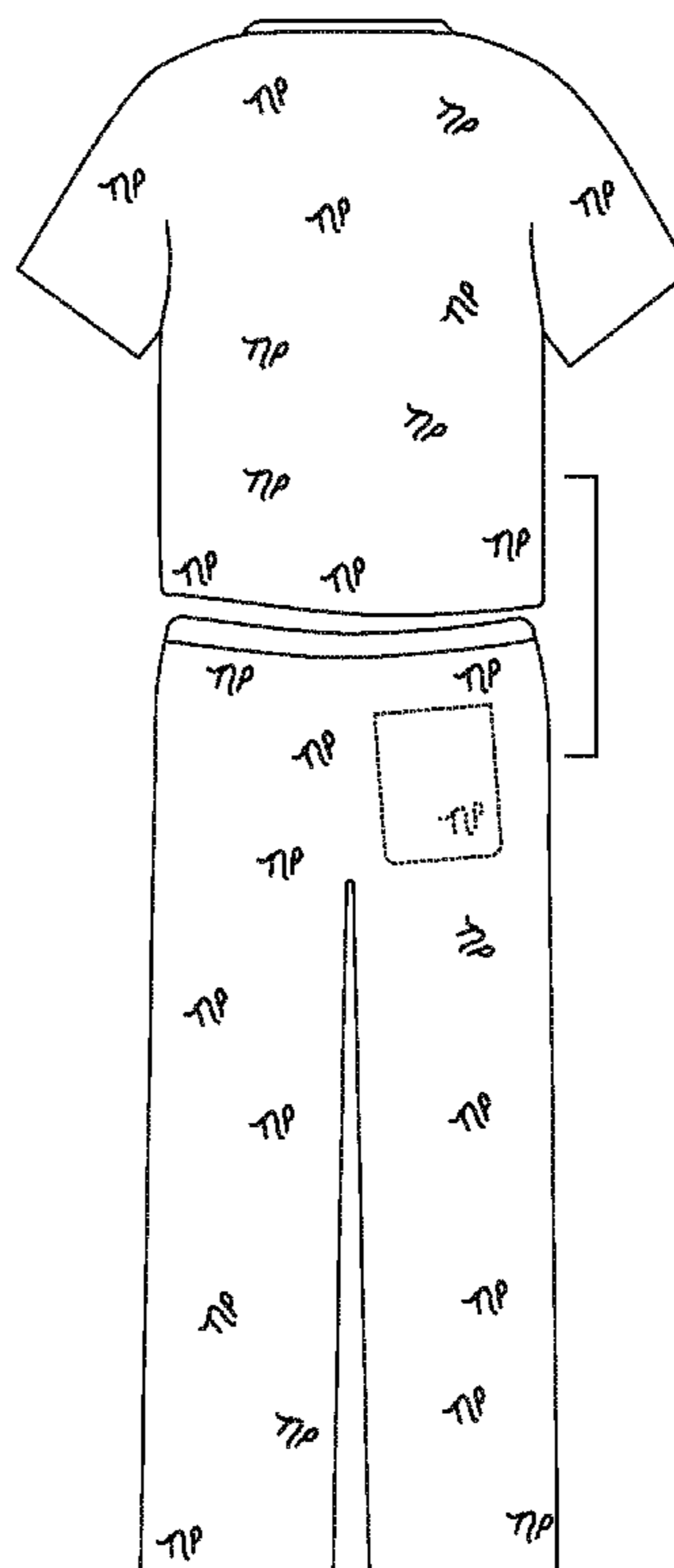
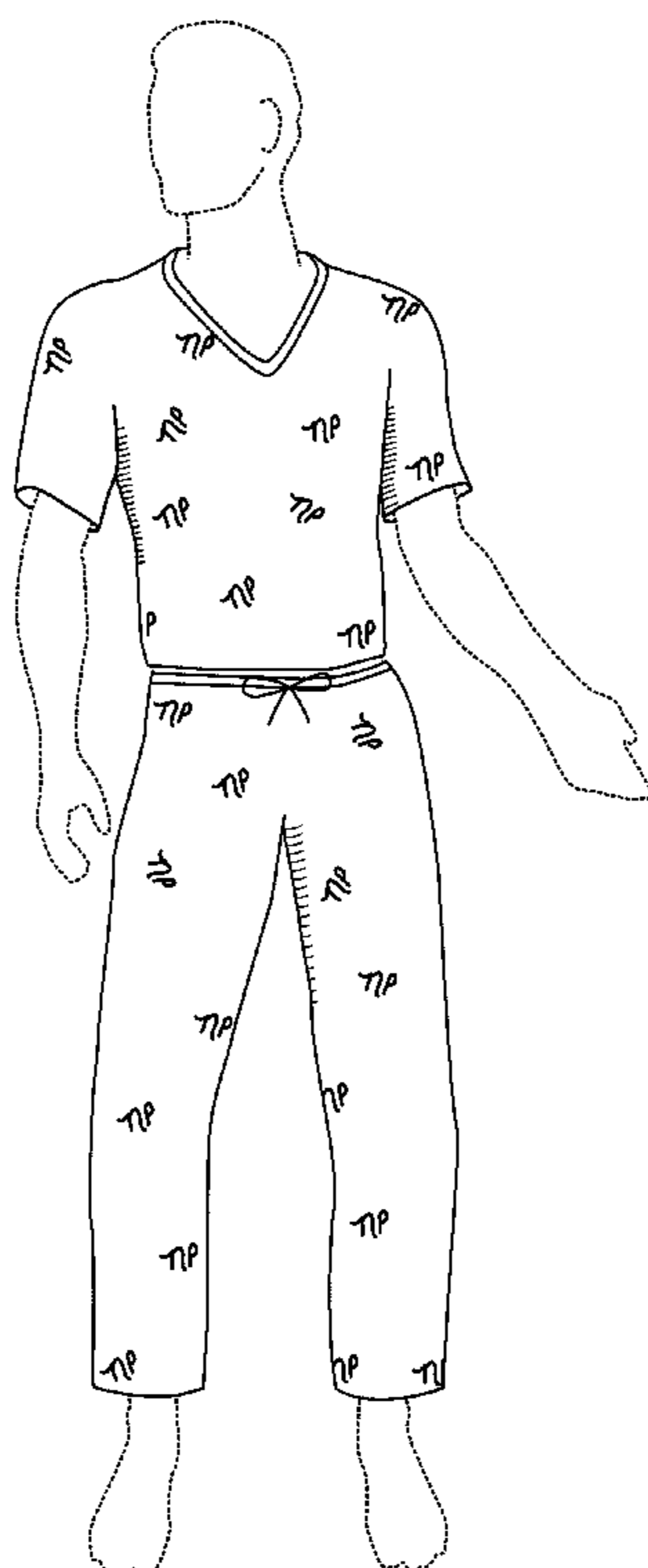

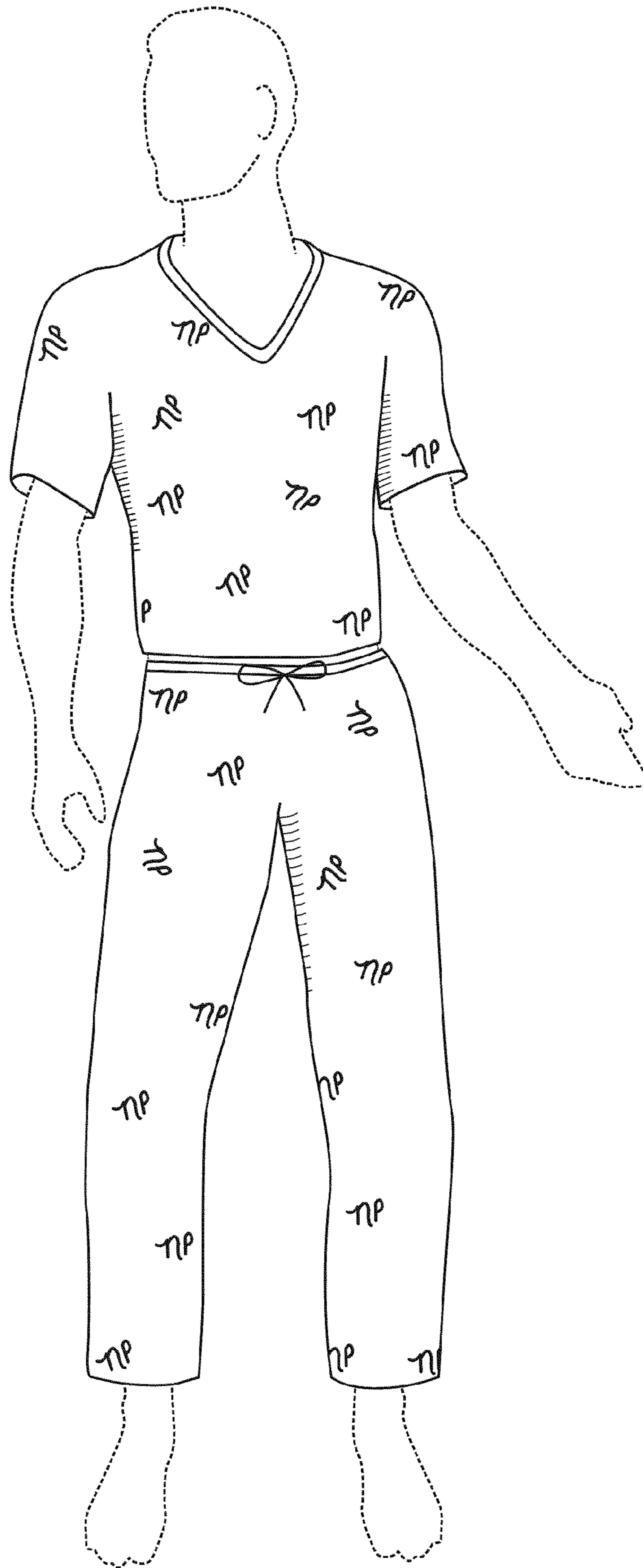

FIG. 1

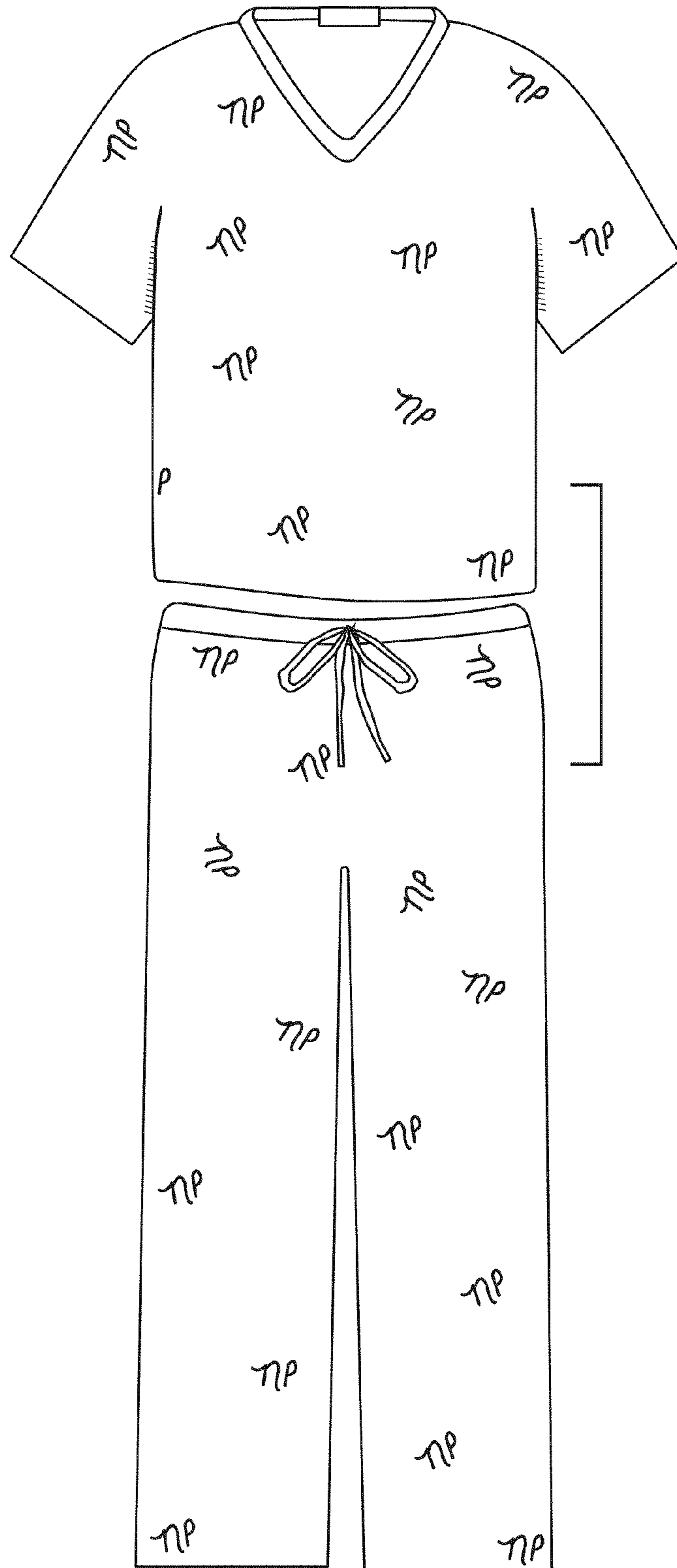

FIG. 2

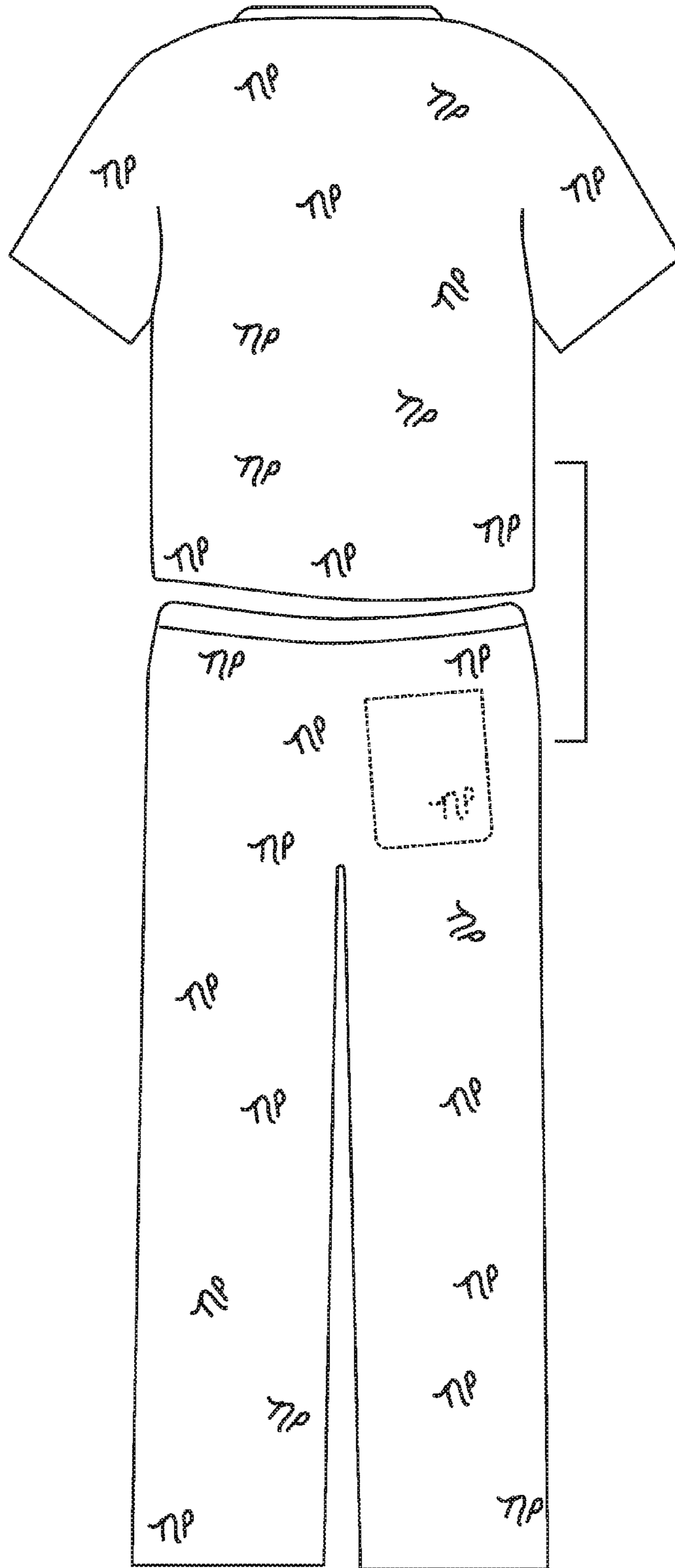

FIG. 3

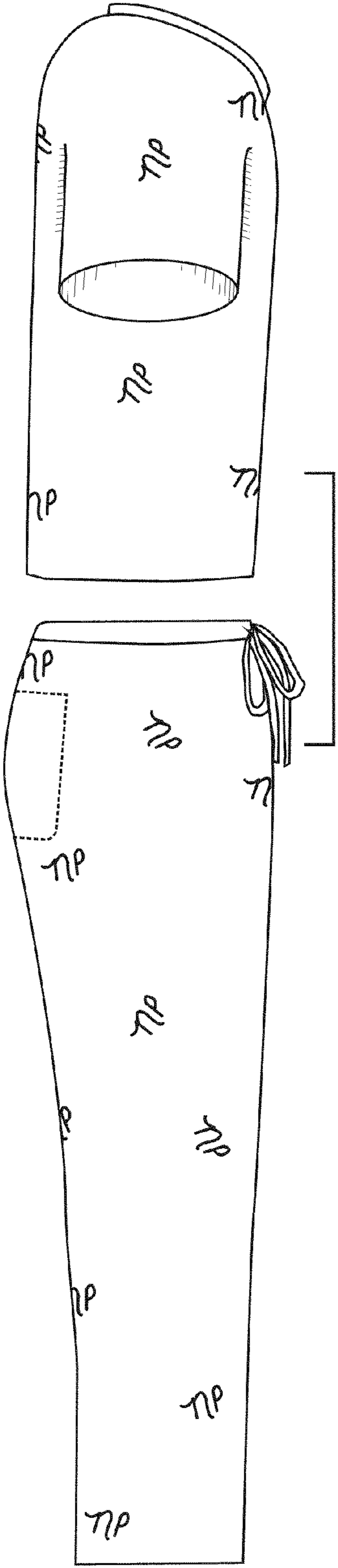

FIG. 4

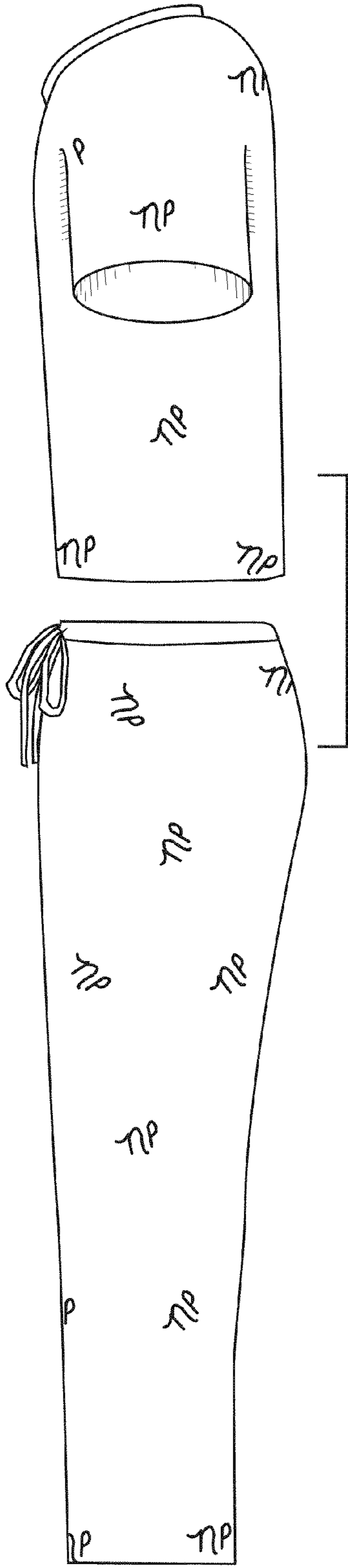

FIG. 5

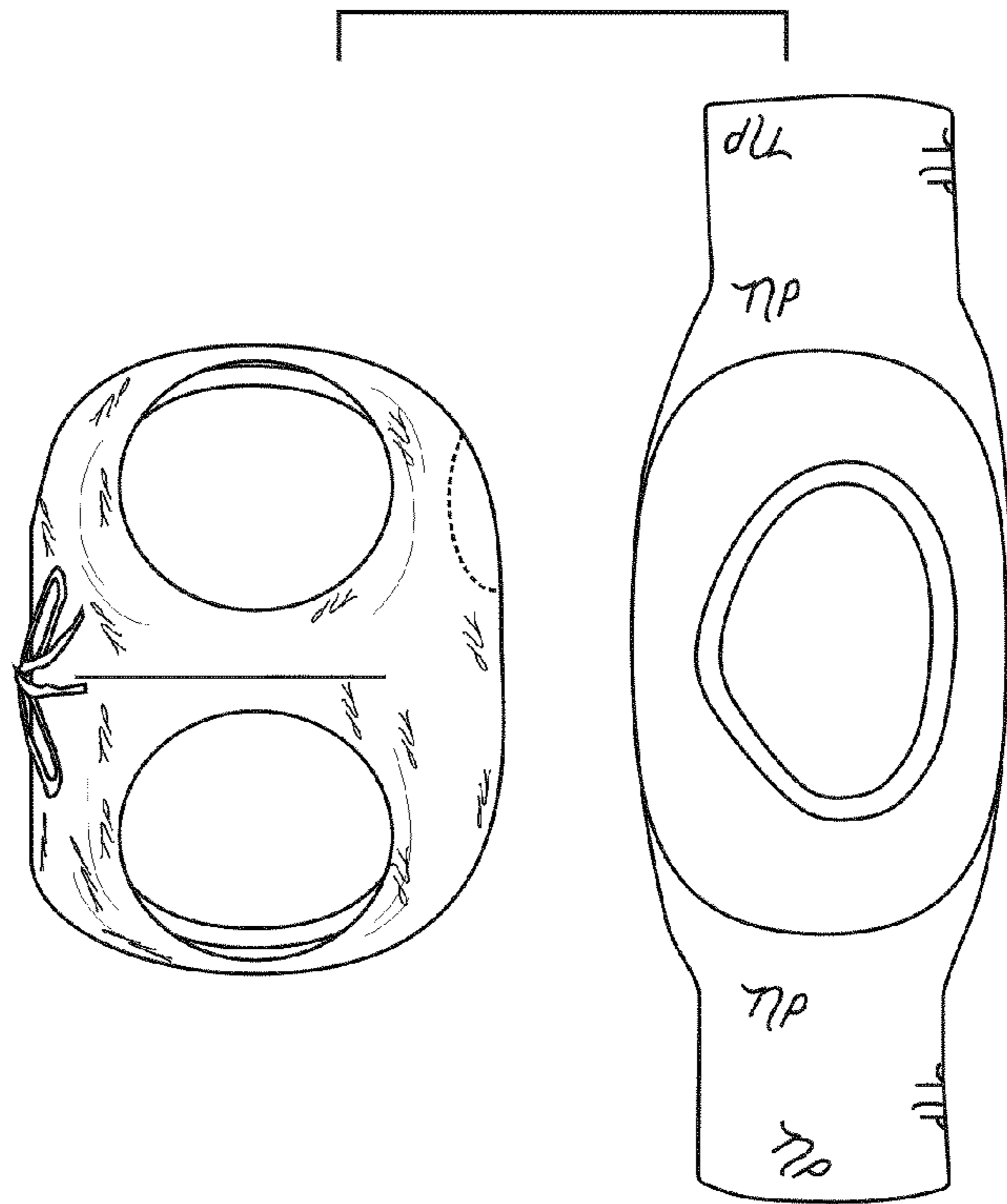

FIG. 6

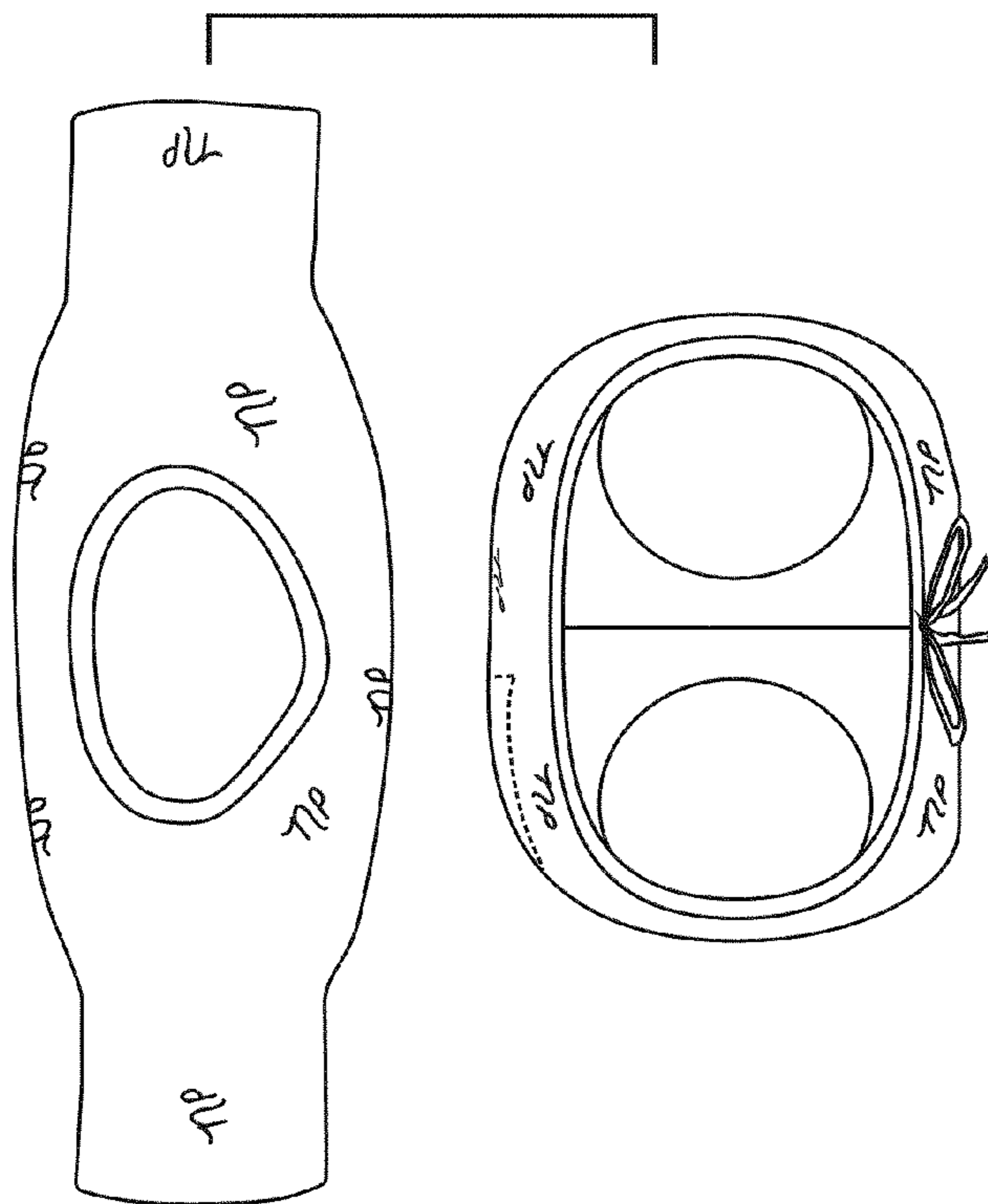

FIG. 7