



US00D638992S

(12) **United States Design Patent**
Moyer

(10) **Patent No.:** **US D638,992 S**
(45) **Date of Patent:** **** May 31, 2011**

(54) **LOTION APPLICATOR PUMMEL**

DESCRIPTION

(76) Inventor: **Lynda Moyer**, Bailey, CO (US)

(**) Term: **14 Years**

(21) Appl. No.: **29/372,310**

(22) Filed: **Nov. 8, 2010**

(51) **LOC (9) Cl.** **28-02**

(52) **U.S. Cl.** **D28/7**

(58) **Field of Classification Search** D28/7,
D28/8, 20–22, 30–31, 76, 85, 99; 132/108,
132/202, 208, 317, 320; 401/202–207, 261–267;
D4/132–135; D24/119; D9/723–726; D32/19,
D32/40, 52

See application file for complete search history.

(56) **References Cited**

U.S. PATENT DOCUMENTS

D149,953 S *	6/1948	Kruck	D28/7
D149,955 S *	6/1948	Kruck	D28/7
D331,639 S *	12/1992	Thompson	D28/7
D416,112 S *	11/1999	Holliday et al.	D32/19
D437,095 S *	1/2001	Osiecki et al.	D32/40
D490,561 S *	5/2004	Angeletta	D28/7
D493,914 S *	8/2004	Vena et al.	D28/7
D507,075 S *	7/2005	Ames	D28/7
D522,202 S *	5/2006	Huang	D32/52

* cited by examiner

Primary Examiner — Zenia Bennett

(74) *Attorney, Agent, or Firm* — Scott L. Terrell, P.C.; Scott L. Terrell

(57) **CLAIM**

The ornamental design for a lotion applicator pummel, as shown and described.

FIG. 1 is an isometric view of the lotion applicator pummel showing the top from a rear-left perspective in an embodiment where no lotion applicator pad is attached to the pummel body.

FIG. 2 is an isometric view of the lotion applicator pummel showing the bottom from a right-side perspective as illustrated in the embodiment according to FIG. 1.

FIG. 3 is a rear view of the lotion applicator pummel as illustrated in the embodiment according to FIG. 1.

FIG. 4 is a front view of the lotion applicator pummel as illustrated in the embodiment according to FIG. 1.

FIG. 5 is a left side view of the lotion applicator pummel as illustrated in the embodiment according to FIG. 1.

FIG. 6 is a top view of the lotion applicator pummel as illustrated in the embodiment according to FIG. 1.

FIG. 7 is a bottom view of the lotion applicator pummel as illustrated in the embodiment according to FIG. 1.

FIG. 8 is an isometric view of the lotion applicator pummel showing the top from a rear-left perspective with a second embodiment where an elliptical lotion applicator pad attachment ring is snapped in place to side walls of lotion applicator pummel body. The dotted line represents an interchangeable lotion applicator pad material which forms no part of the claimed design.

FIG. 9 is an isometric view of the lotion applicator pummel showing the bottom from a right-side perspective as illustrated in the embodiment according to FIG. 8.

FIG. 10 is a rear view of the lotion applicator pummel as illustrated in the embodiment according to FIG. 8.

FIG. 11 is a front view of the lotion applicator pummel as illustrated in the embodiment according to FIG. 8.

FIG. 12 is a left-side view of the lotion applicator pummel as illustrated in the embodiment according to FIG. 8.

FIG. 13 is a top view of the lotion applicator pummel as illustrated in the embodiment according to FIG. 8; and,

FIG. 14 is a bottom view of the lotion applicator pummel as illustrated in the embodiment according to FIG. 8.

1 Claim, 6 Drawing Sheets

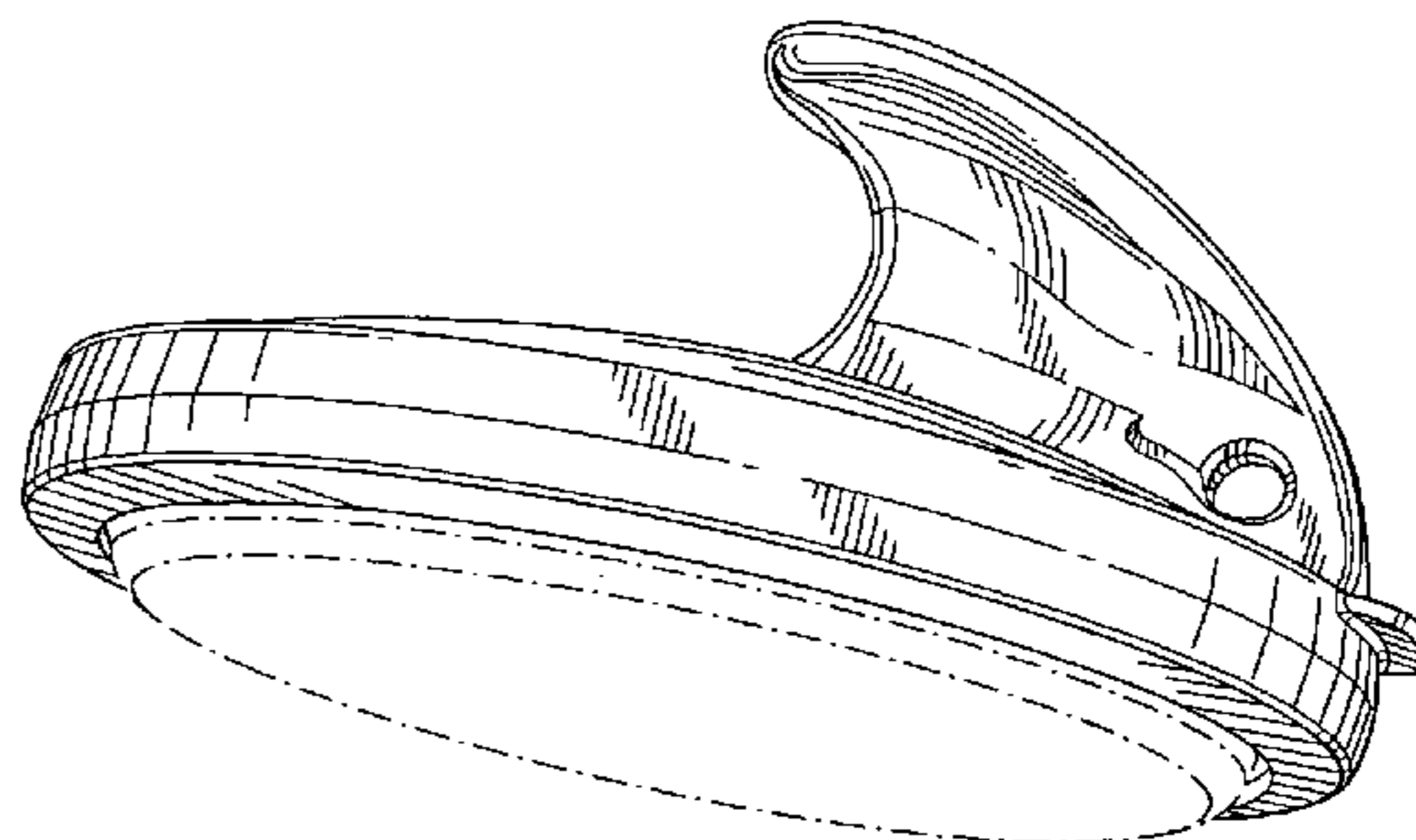
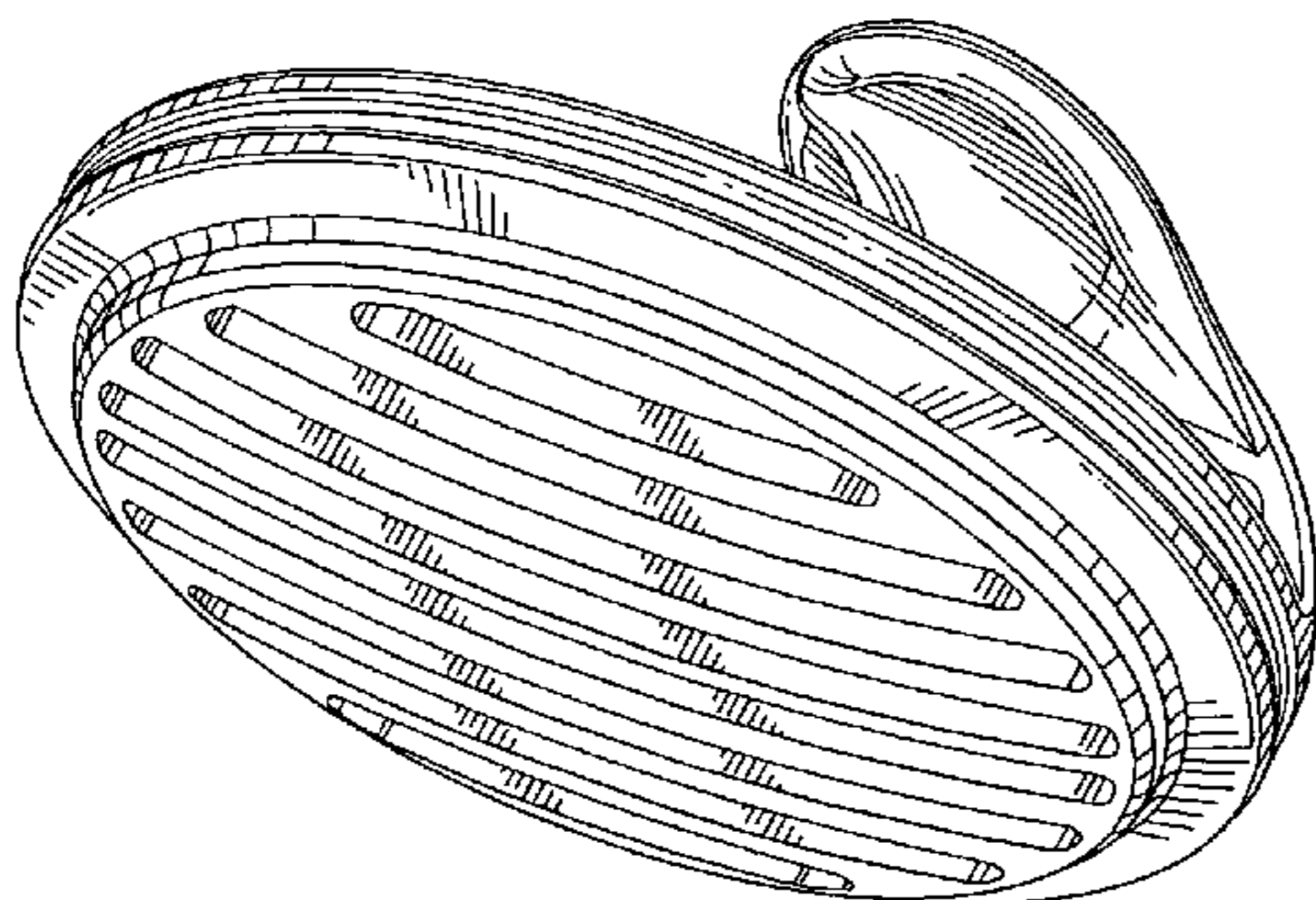

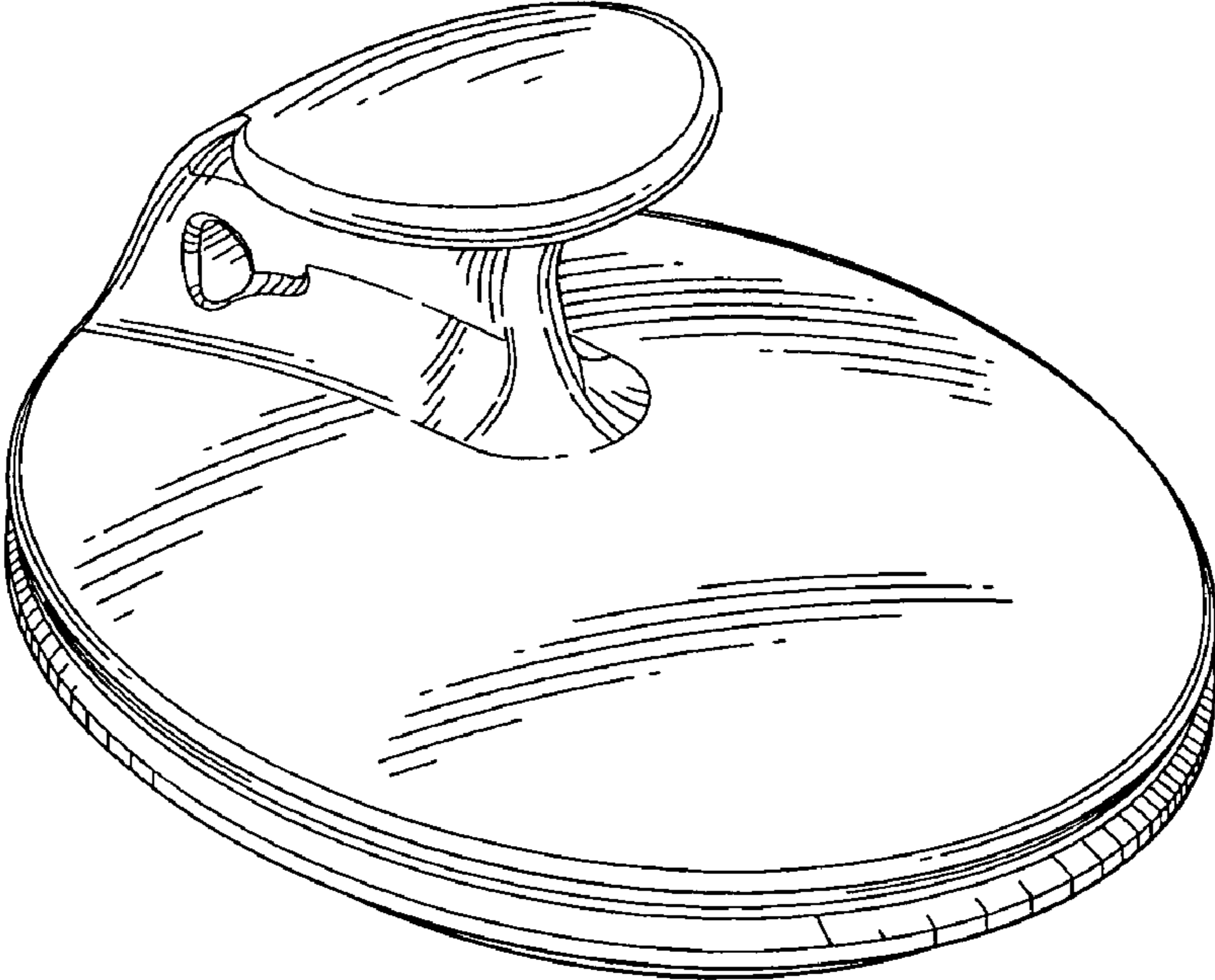

FIG. 1

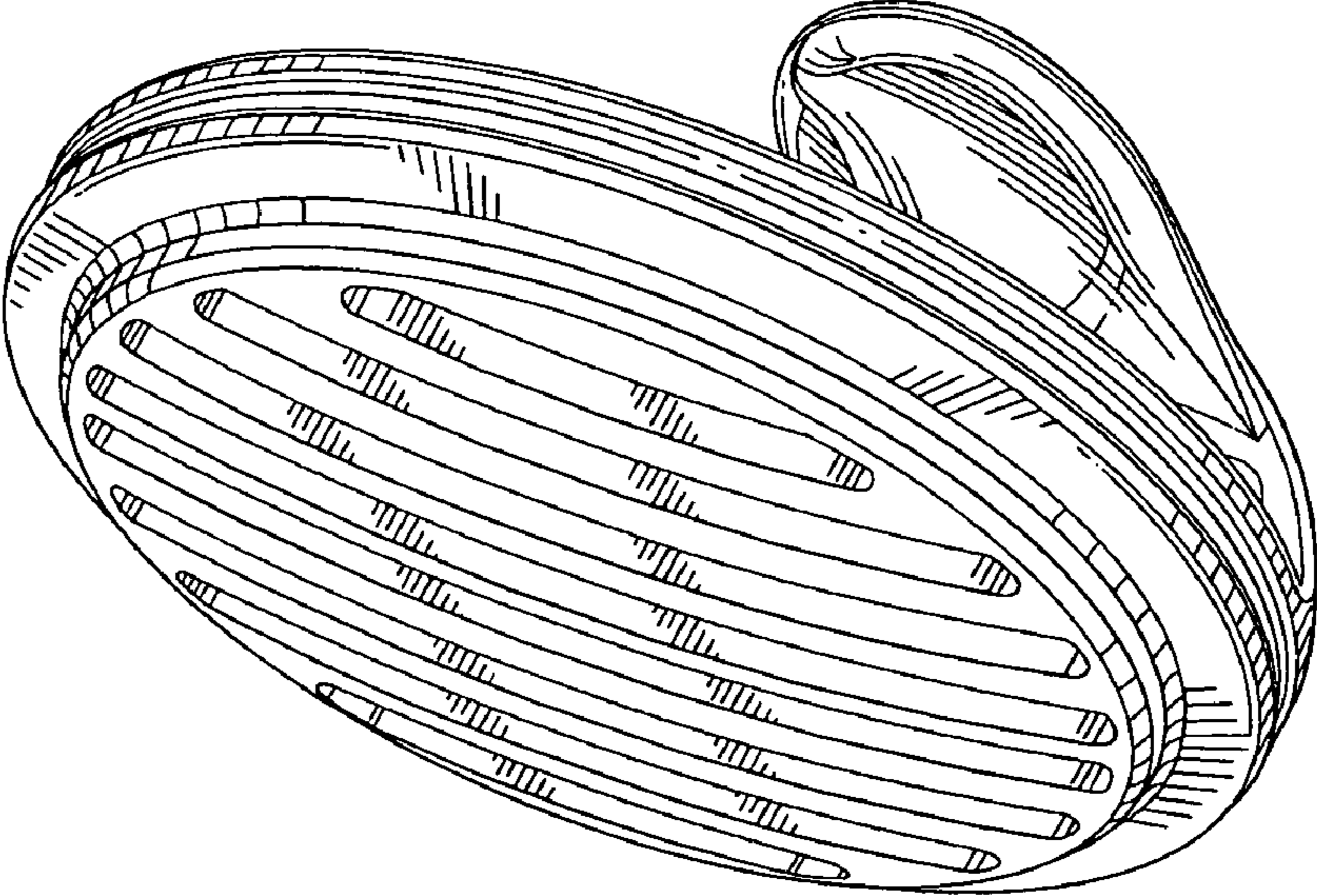

FIG. 2

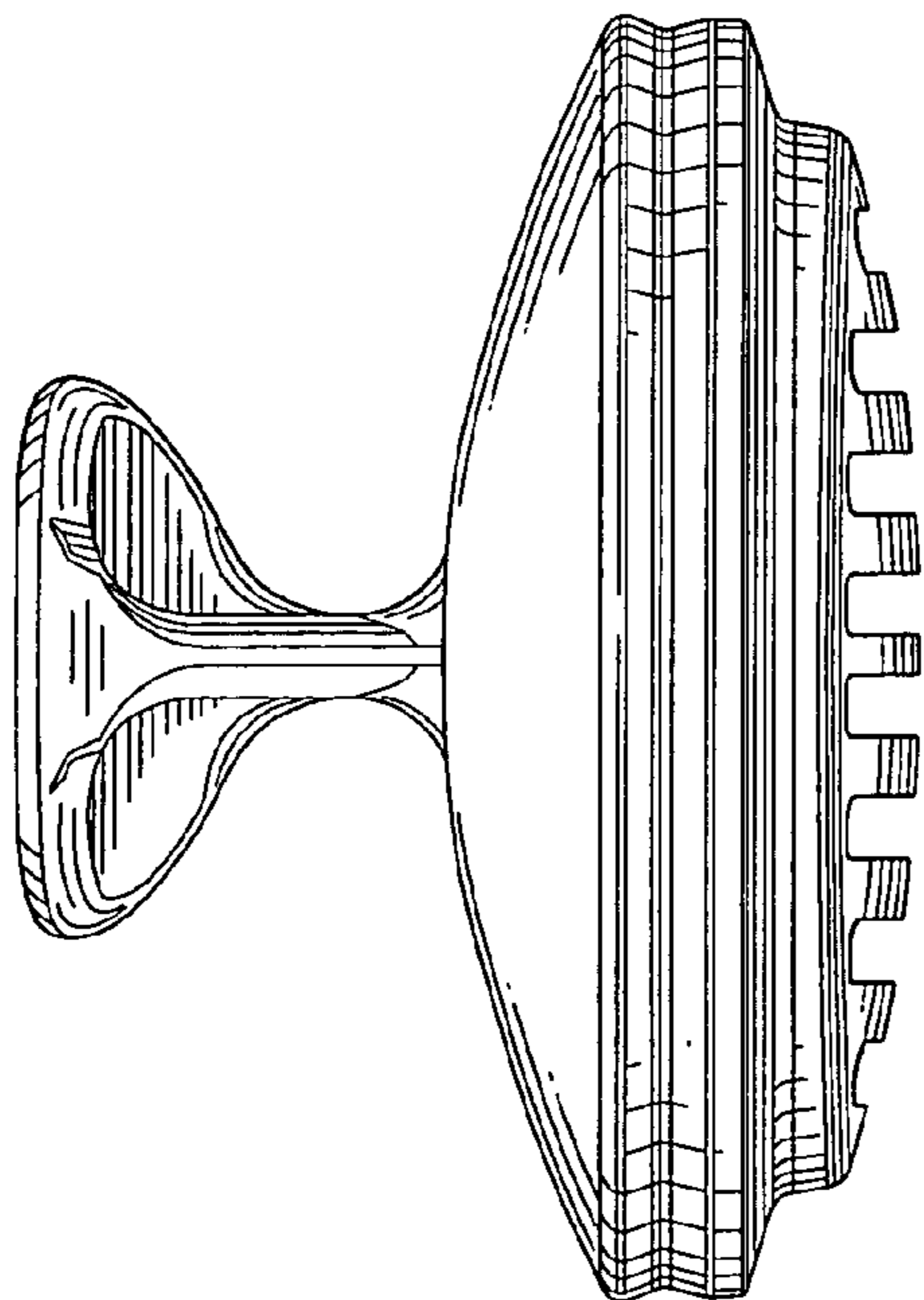

FIG. 3

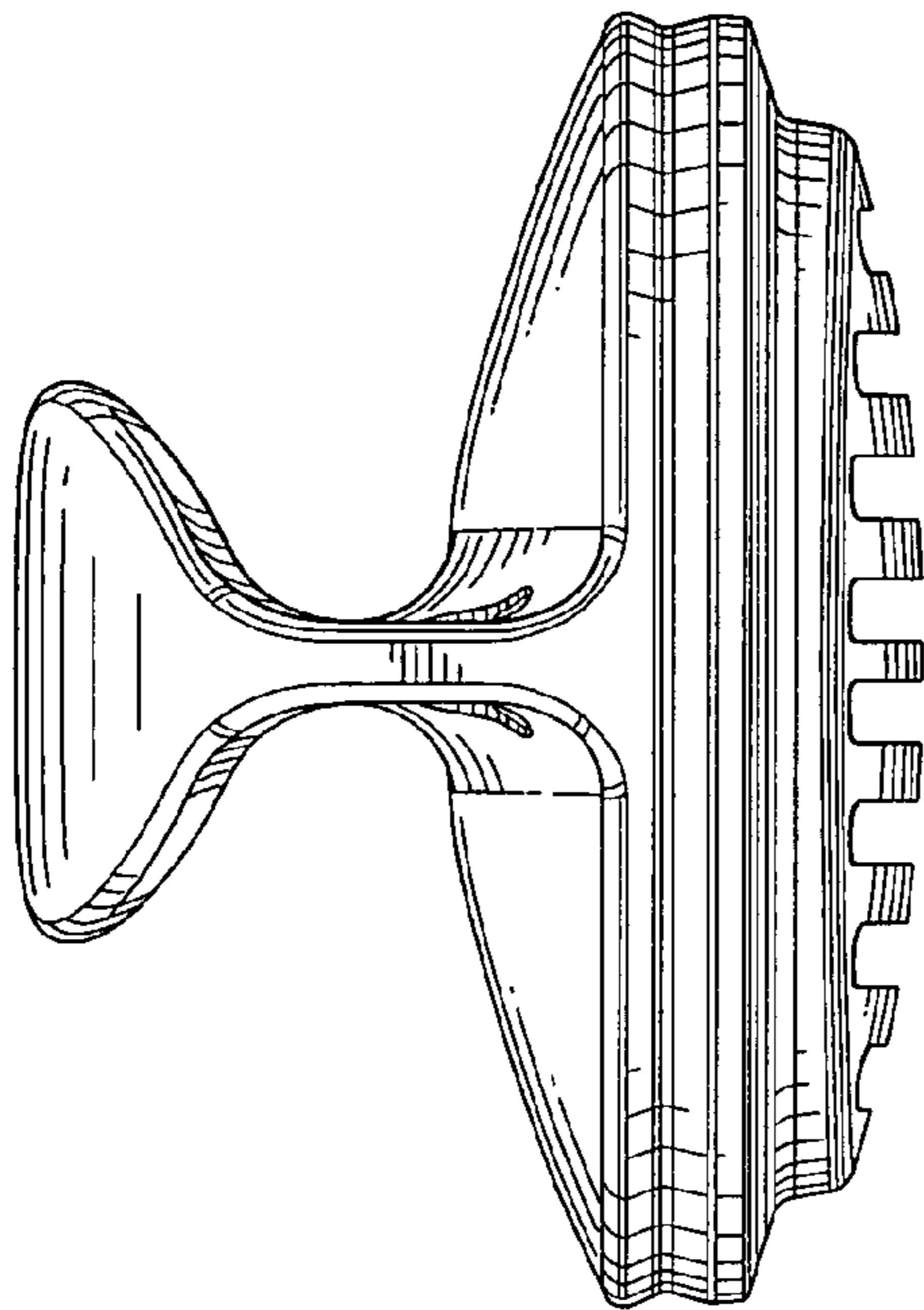

FIG. 4

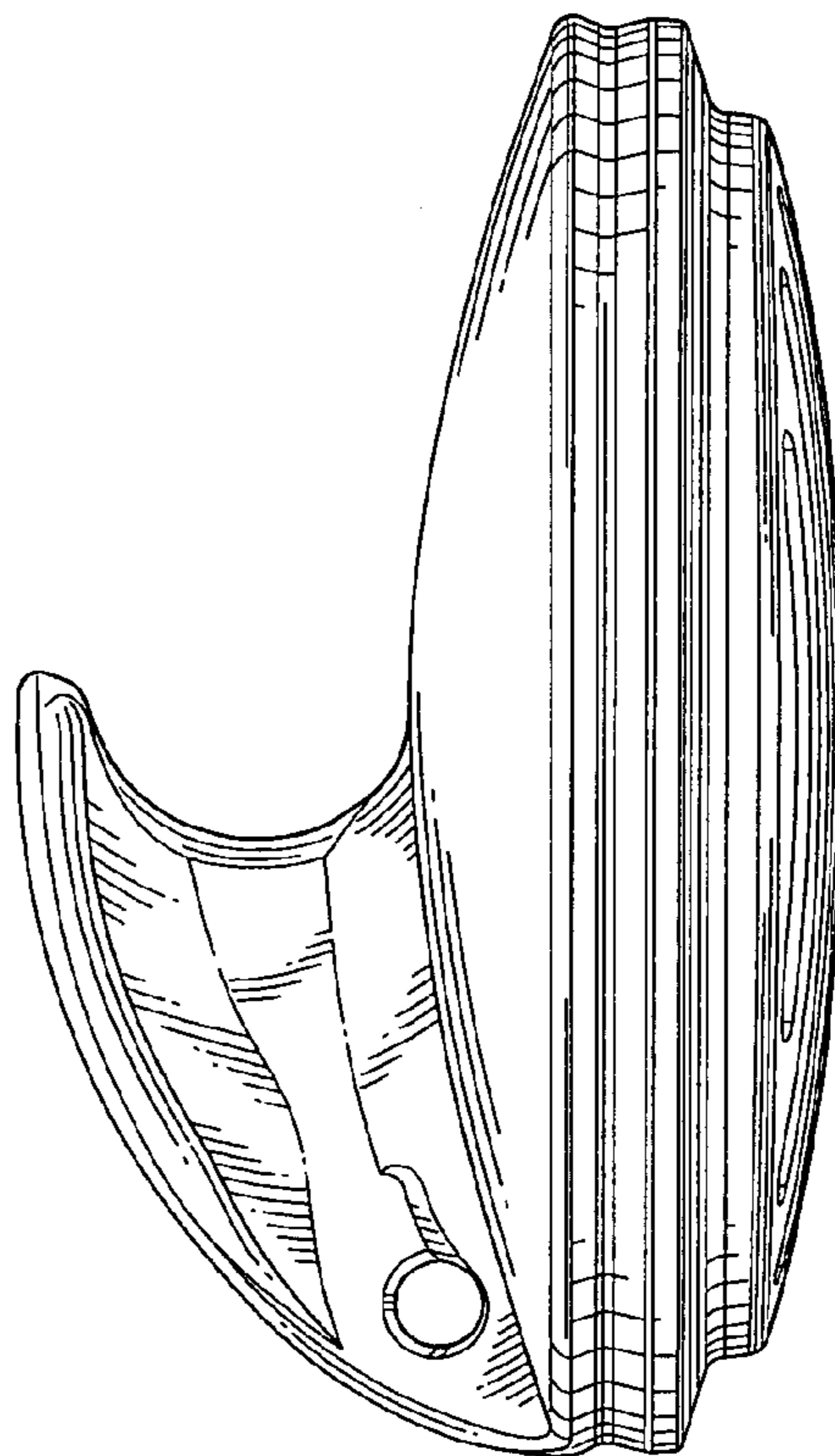

FIG. 5

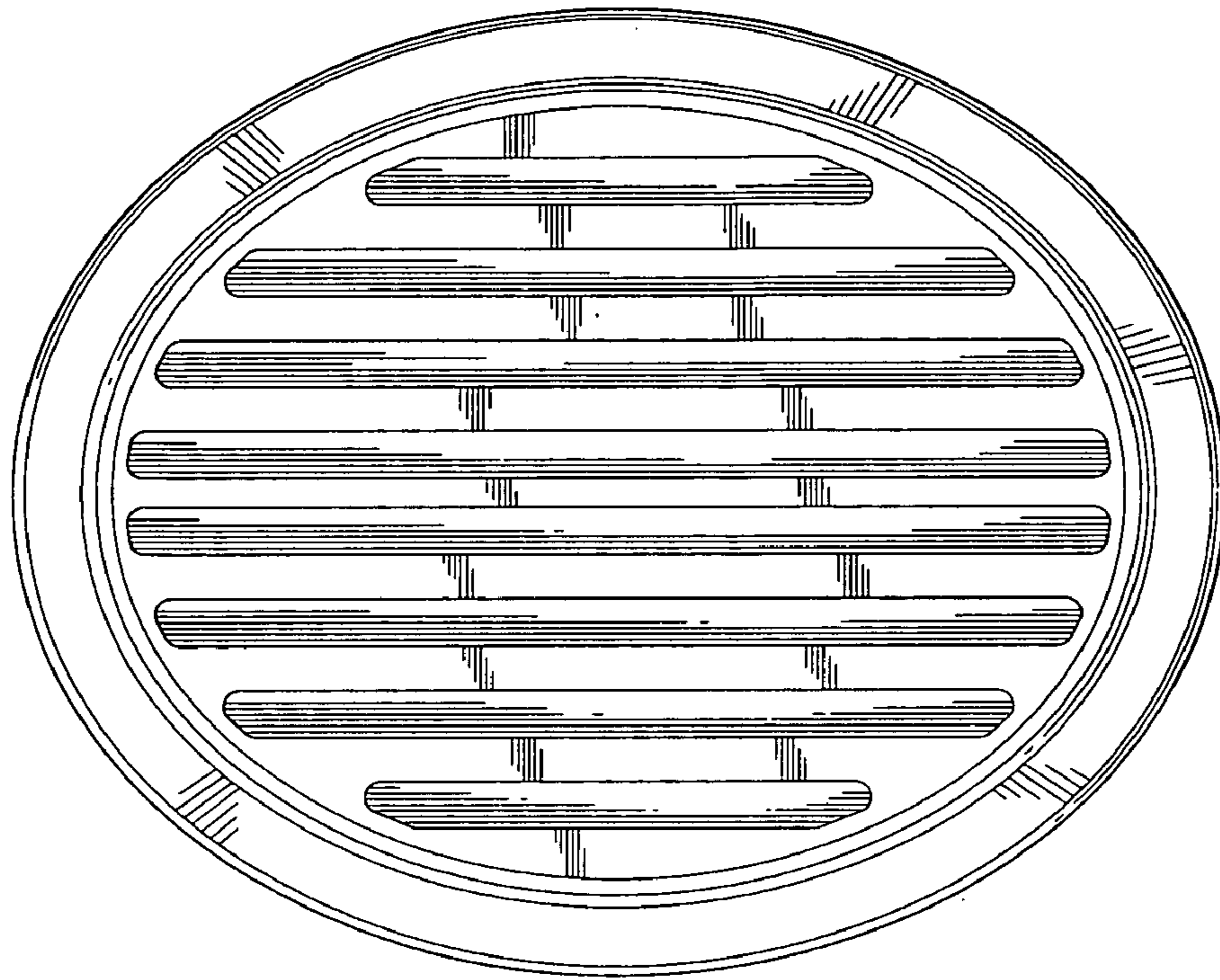

FIG. 7

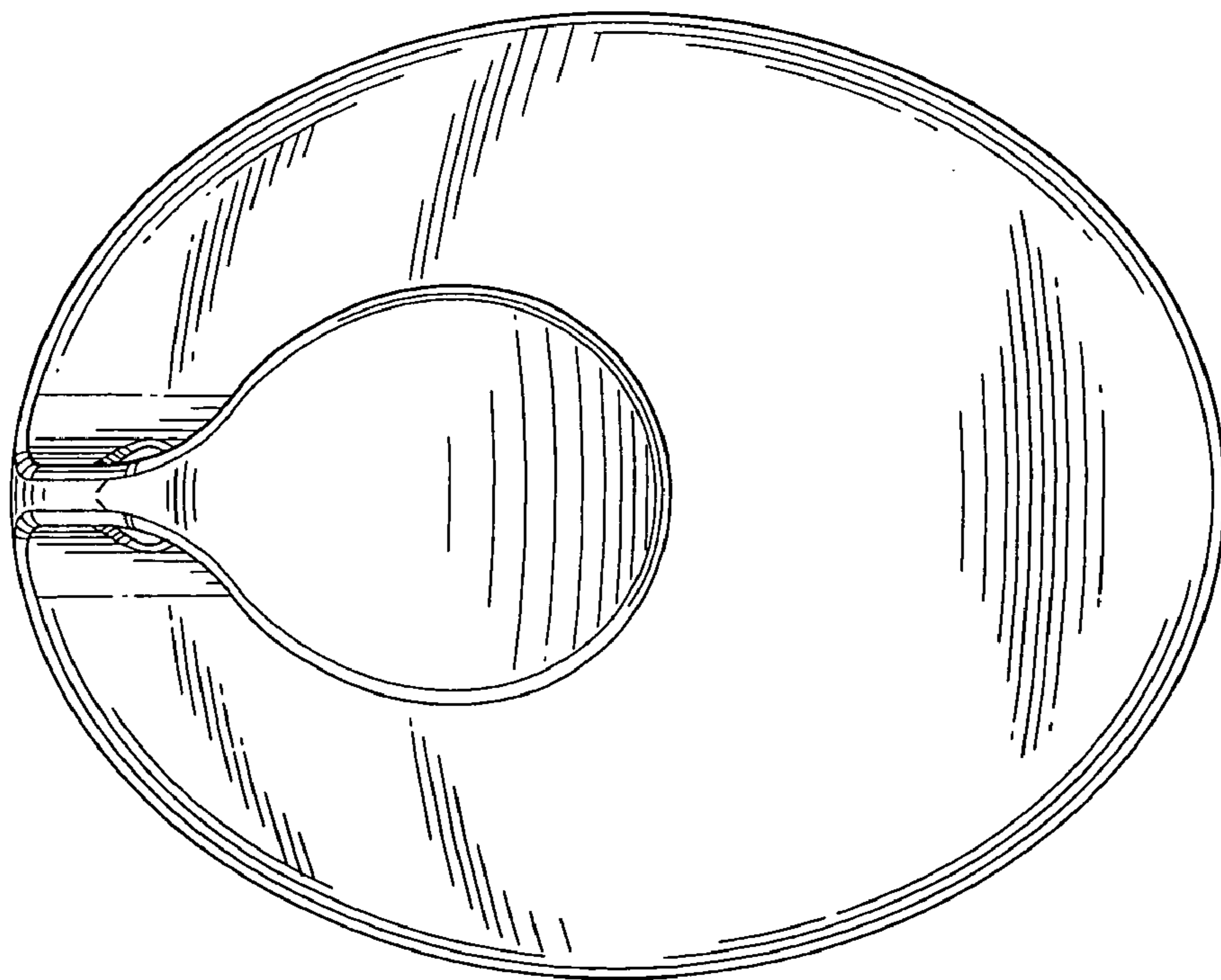

FIG. 6

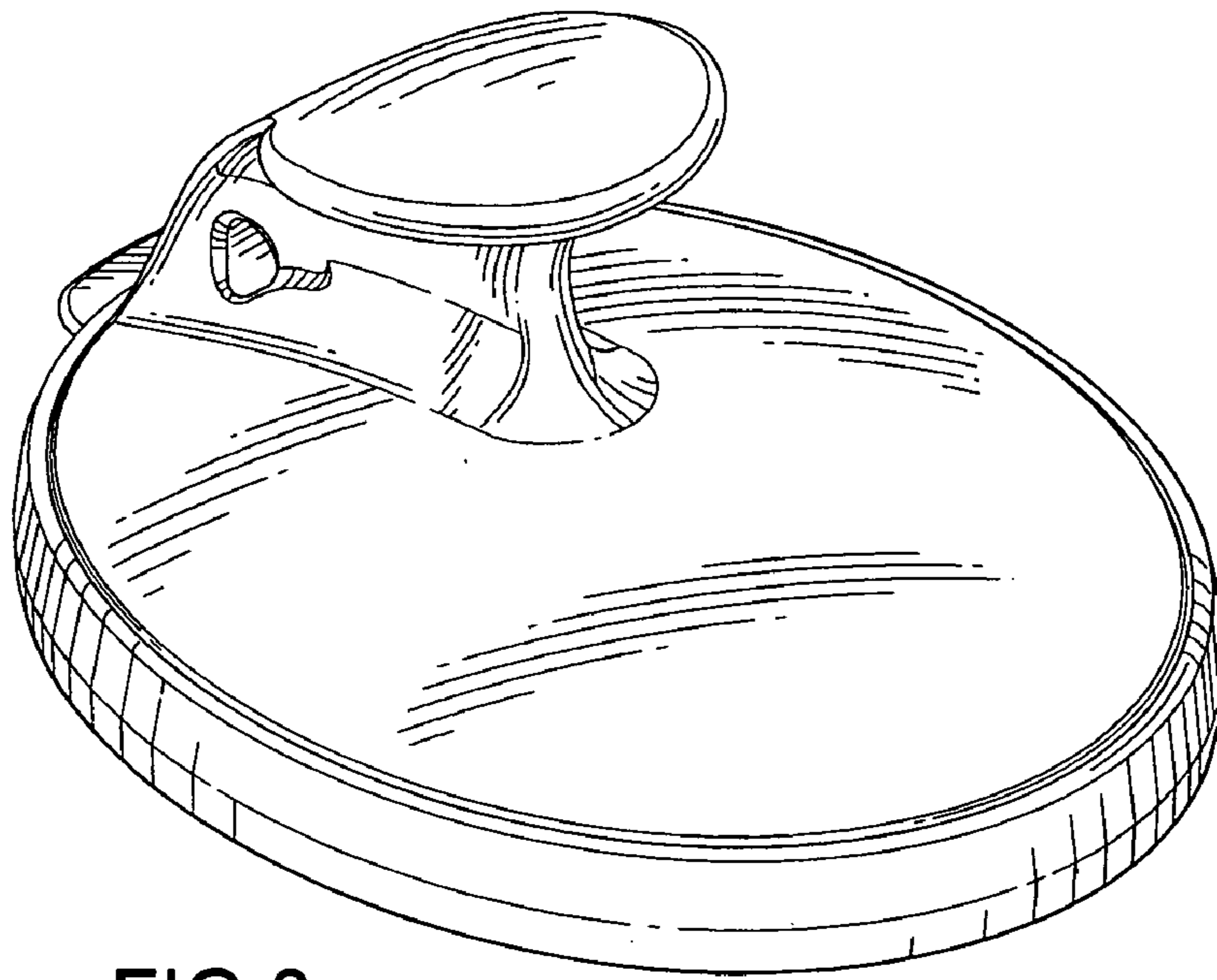

FIG. 8

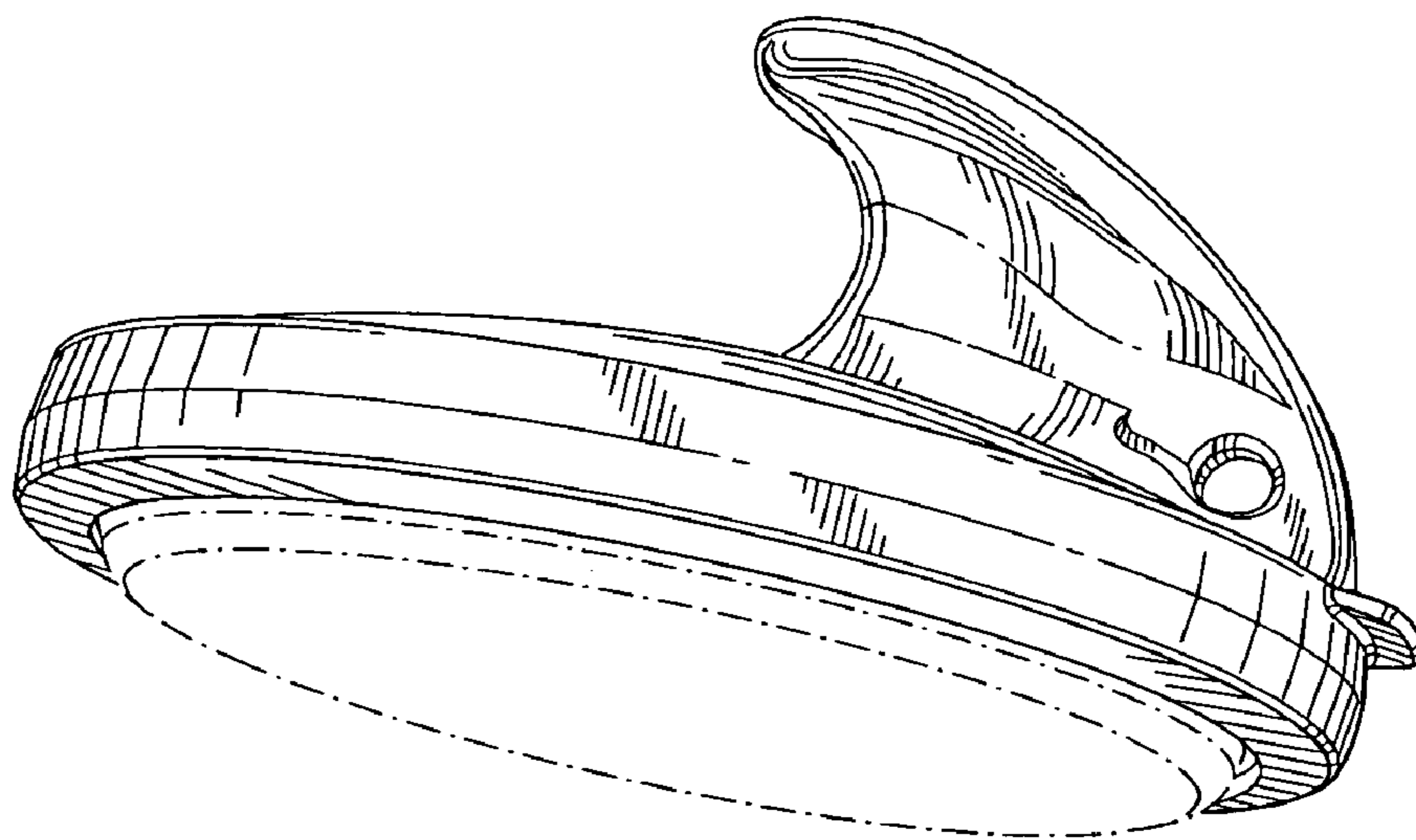

FIG. 9

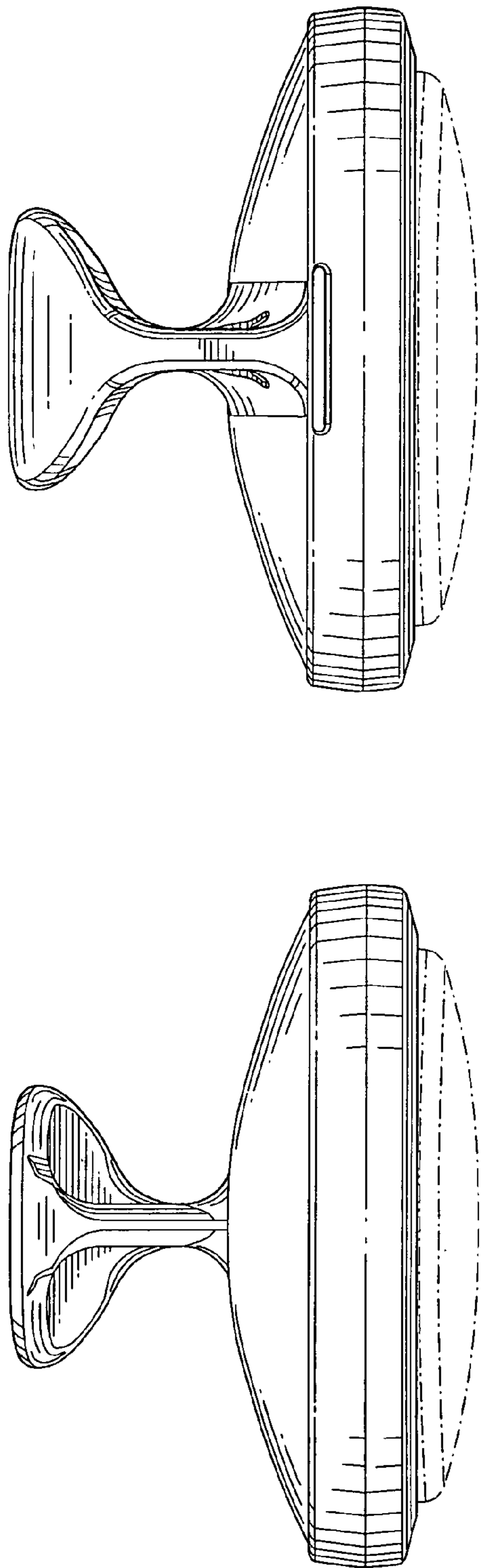

FIG.11

FIG.10

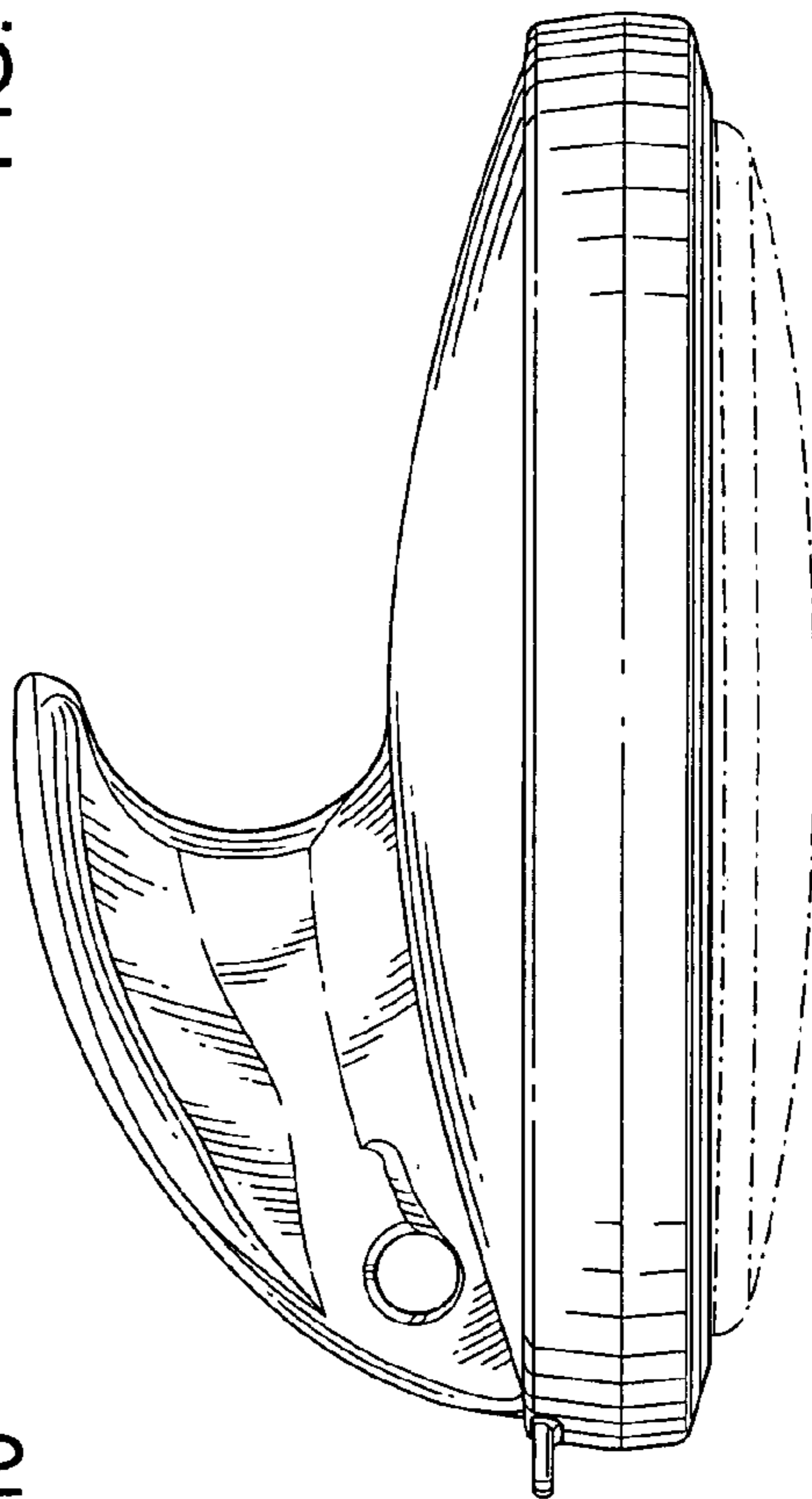

FIG.12

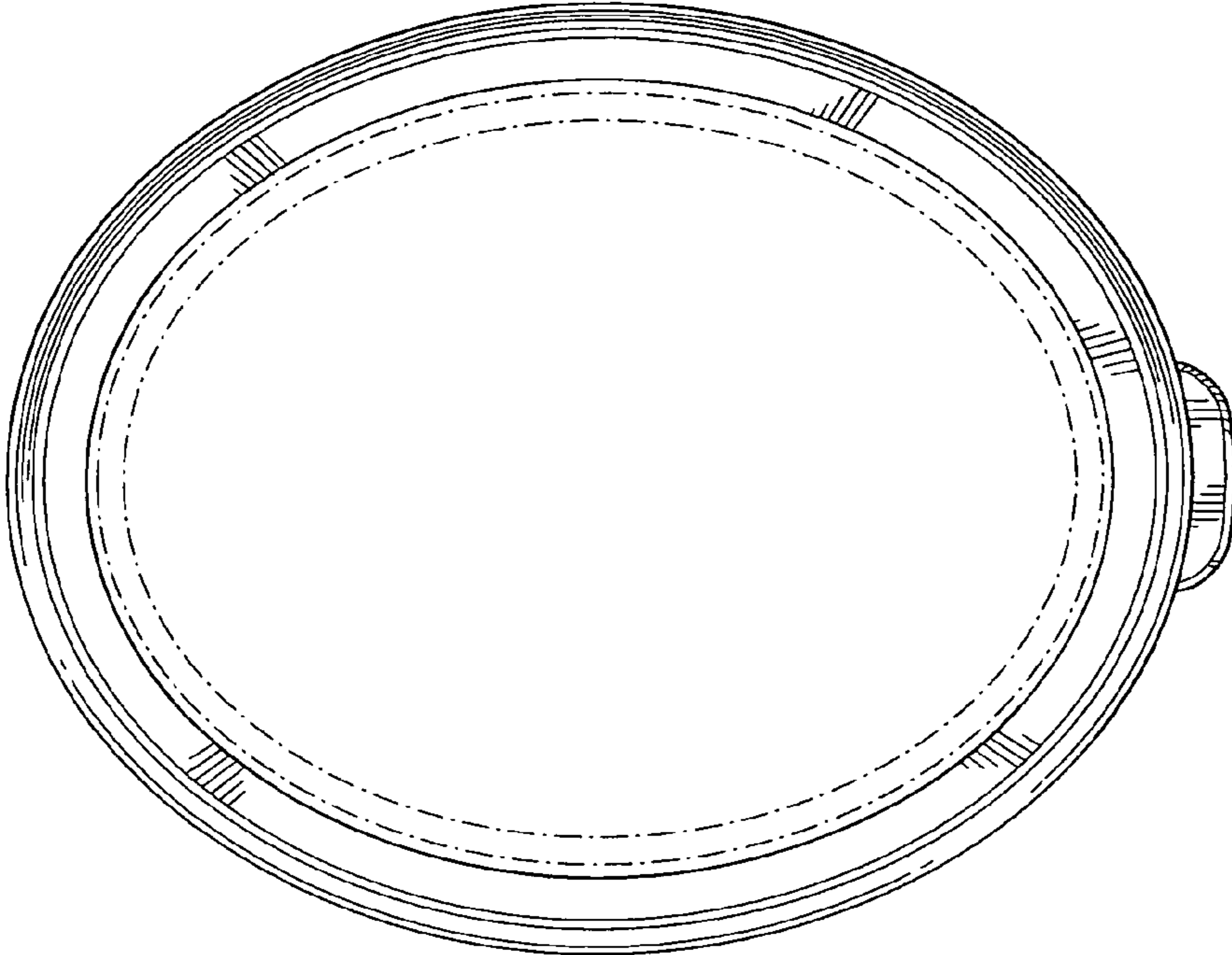

FIG.14

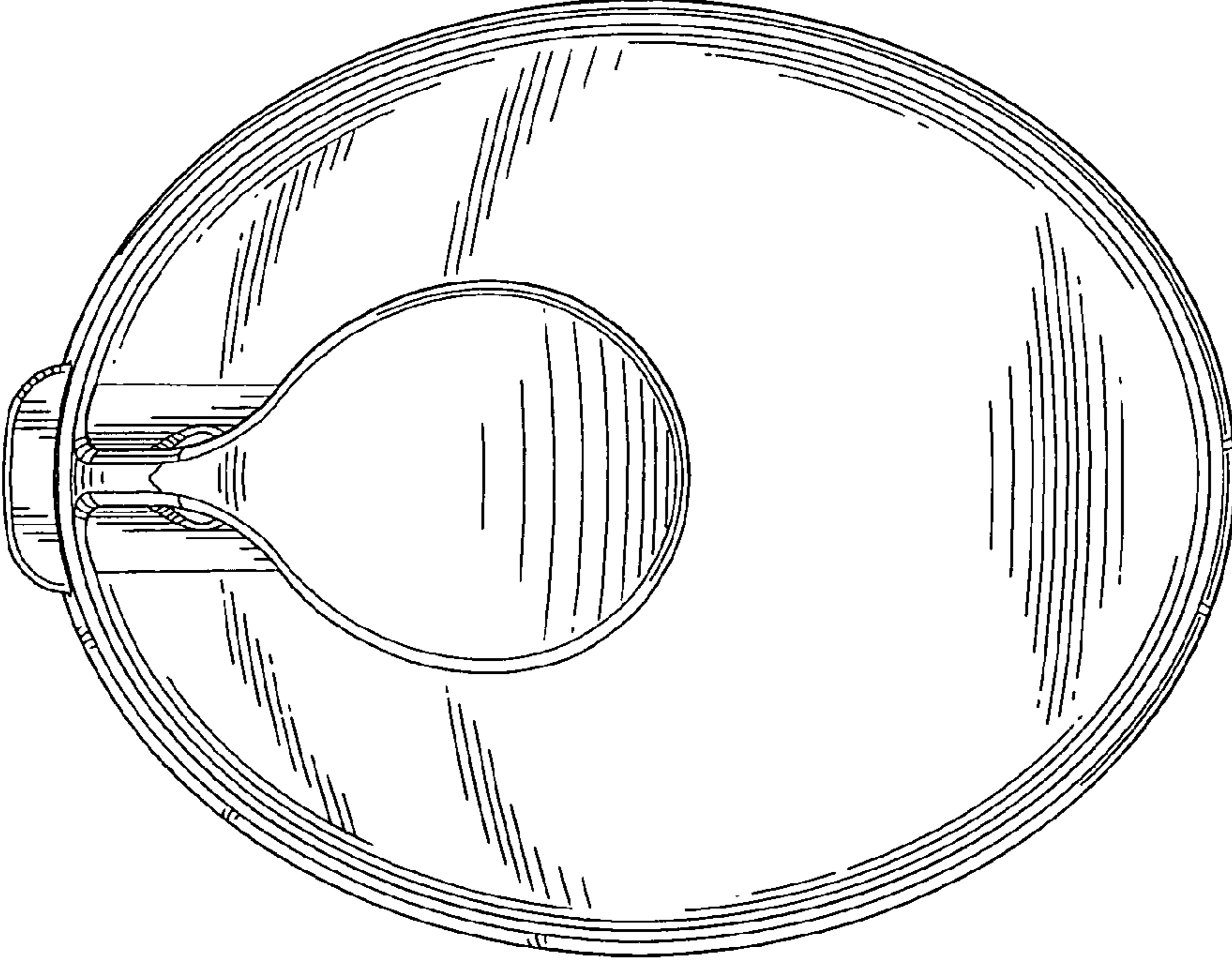

FIG.13