



US00D638956S

(12) **United States Design Patent**
Walsh et al.

(10) **Patent No.:** **US D638,956 S**
(45) **Date of Patent:** **** May 31, 2011**

(54) **DOOR FACING**

(75) Inventors: **Jason M. Walsh**, Batavia, IL (US);
Robert C. Allen, Elburn, IL (US);
Steven K. Lynch, St. Charles, IL (US);
Mark A. Ruggie, Franklin Park, IL (US)

(73) Assignee: **Masonite Corporation**, Tampa, FL (US)

(**) Term: **14 Years**

(21) Appl. No.: **29/360,738**

(22) Filed: **Apr. 30, 2010**

Related U.S. Application Data

(62) Division of application No. 29/303,385, filed on Feb. 7, 2008, now Pat. No. Des. 615,212.

(51) **LOC (9) Cl.** **25-02**

(52) **U.S. Cl.** **D25/48**

(58) **Field of Classification Search** D25/48;
52/313, 314, 455; 49/501, 504

See application file for complete search history.

(56) **References Cited**

U.S. PATENT DOCUMENTS

1,212,005	A *	1/1917	Biberfeld	160/231.1
2,491,498	A *	12/1949	Kahr	52/313
D212,466	S *	10/1968	Esteban y Bartolome	D25/48
D248,326	S *	6/1978	Stichtenoth	D25/48
D380,053	S *	6/1997	Forsland	D25/48
D516,225	S *	2/2006	Lynch et al.	D25/48

* cited by examiner

Primary Examiner — Doris Clark

(74) *Attorney, Agent, or Firm* — Berenato & White, LLC

(57) **CLAIM**

The ornamental design for door facings, as shown and described.

DESCRIPTION

FIG. 1 is a perspective view of a first embodiment of our design;

FIG. 2 is a front elevational view of the design of FIG. 1;

FIG. 3 is a rear elevational view common to the designs of FIGS. 1 and 10;

FIG. 4 is a right side elevational view common to the designs of FIGS. 1 and 10;

FIG. 5 is a left side elevational view common to the designs of FIGS. 1 and 10;

FIG. 6 is a top plan view common to the designs of FIGS. 1 and 10;

FIG. 7 is a bottom plan view common to the designs of FIGS. 1 and 10;

FIG. 8 is a cross-sectional view taken along the line 8—8 of FIG. 2 and common to the designs of FIGS. 1 and 10;

FIG. 9 is an enlarged fragmentary cross-sectional view taken from FIG. 8;

FIG. 10 is a perspective view of a second embodiment;

FIG. 11 is a front elevational view of the design of FIG. 10;

FIG. 12 is a perspective view of a third embodiment of our design;

FIG. 13 is a front elevational view of the design of FIG. 12;

FIG. 14 is a rear elevational view common to the designs of FIGS. 12 and 21;

FIG. 15 is a right side elevational view common to the designs of FIGS. 12 and 21;

FIG. 16 is a left side elevational view common to the designs of FIGS. 12 and 21;

FIG. 17 is a top plan view common to the designs of FIGS. 12 and 21;

FIG. 18 is a bottom plan view common to the designs of FIGS. 12 and 21;

FIG. 19 is a cross-sectional view taken along the line 19—19 of FIG. 13 and common to the designs of FIGS. 12 and 21;

FIG. 20 is an enlarged fragmentary cross-sectional view taken from FIG. 19;

FIG. 21 is a perspective view of a fourth embodiment;

FIG. 22 is a front elevational view of the design of FIG. 21;

FIG. 23 is a perspective view of a fifth embodiment of our design;

FIG. 24 is a front elevational view of the design of FIG. 23;

FIG. 25 is a rear elevational view common to the designs of FIGS. 23 and 32;

FIG. 26 is a right side elevational view common to the designs of FIGS. 23 and 32;

FIG. 27 is a left side elevational view common to the designs of FIGS. 23 and 32;

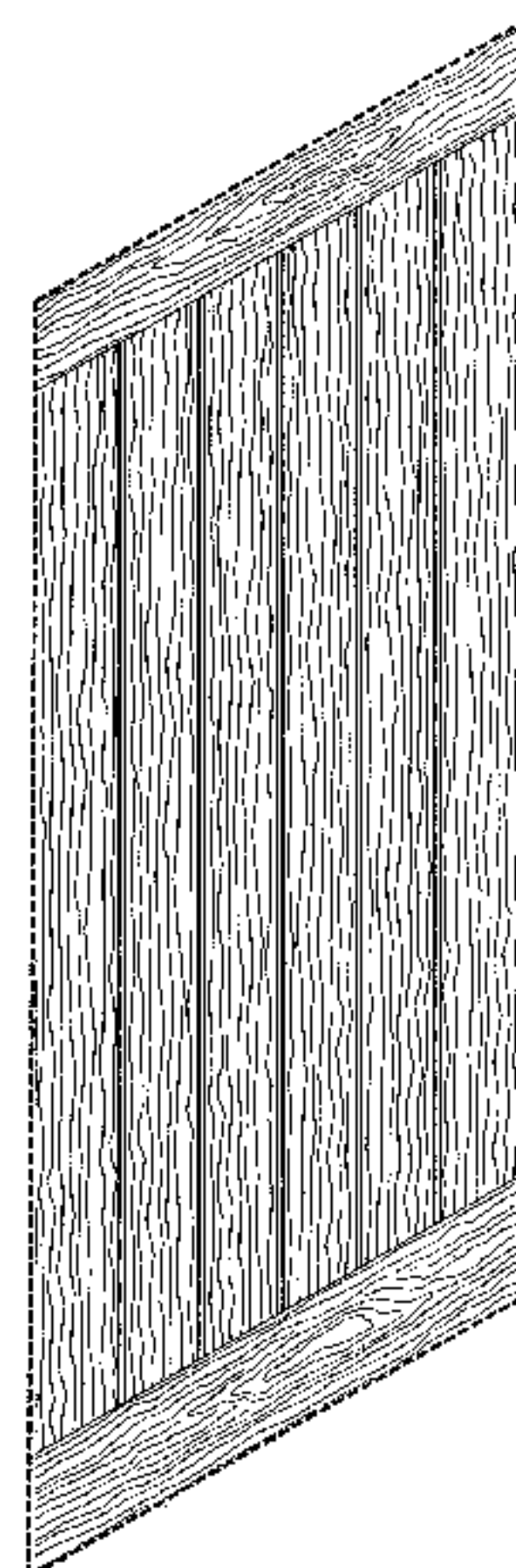

FIG. 28 is a top plan view common to the designs of FIGS. 23 and 32;
FIG. 29 is a bottom plan view common to the designs of FIGS. 23 and 32;
FIG. 30 is a cross-sectional view taken along the line 30—30 of FIG. 24 and common to the designs of FIGS. 23 and 32;
FIG. 31 is an enlarged fragmentary cross-sectional view taken from FIG. 30;
FIG. 32 is a perspective view of a sixth embodiment;
FIG. 33 is a front elevational view of the design of FIG. 32;
FIG. 34 is a perspective view of a seventh embodiment of our design;
FIG. 35 is a front elevational view of the design of FIG. 34;
FIG. 36 is a rear elevational view common to the designs of FIGS. 34 and 43;
FIG. 37 is a right side elevational view common to the designs of FIGS. 34 and 43;
FIG. 38 is a left side elevational view common to the designs of FIGS. 34 and 43;
FIG. 39 is a top plan view common to the designs of FIGS. 34 and 43;
FIG. 40 is a bottom plan view common to the designs of FIGS. 34 and 43;
FIG. 41 is a cross-sectional view taken along the line 41—41 of FIG. 35 and common to the designs of FIGS. 34 and 43;
FIG. 42 is an enlarged fragmentary cross-sectional view taken from FIG. 41;
FIG. 43 is a perspective view of an eighth embodiment;
FIG. 44 is a front elevational view of the design of FIG. 43;
FIG. 45 is a perspective view of a ninth embodiment of our design;
FIG. 46 is a front elevational view of the design of FIG. 45;
FIG. 47 is a rear elevational view common to the designs of FIGS. 45 and 54;
FIG. 48 is a right side elevational view common to the designs of FIGS. 45 and 54;
FIG. 49 is a left side elevational view common to the designs of FIGS. 45 and 54;
FIG. 50 is a top plan view common to the designs of FIGS. 45 and 54;
FIG. 51 is a bottom plan view common to the designs of FIGS. 45 and 54;
FIG. 52 is a cross-sectional view taken along the line 52—52 of FIG. 46 and common to the designs of FIGS. 45 and 54;
FIG. 53 is an enlarged fragmentary cross-sectional view taken from FIG. 52;
FIG. 54 is a perspective view of a tenth embodiment;
FIG. 55 is a front elevational view of the design of FIG. 54;
FIG. 56 is a perspective view of an eleventh embodiment of our design;
FIG. 57 is a front elevational view of the design of FIG. 56;
FIG. 58 is a rear elevational view common to the designs of FIGS. 56 and 65;
FIG. 59 is a right side elevational view common to the designs of FIGS. 56 and 65;
FIG. 60 is a left side elevational view common to the designs of FIGS. 56 and 65;
FIG. 61 is a top plan view common to the designs of FIGS. 56 and 65;
FIG. 62 is a bottom plan view common to the designs of FIGS. 56 and 65;
FIG. 63 is a cross-sectional view taken along the line 63—63 of FIG. 57 and common to the designs of FIGS. 56 and 65;
FIG. 64 is an enlarged fragmentary cross-sectional view taken from FIG. 63;

FIG. 65 is a perspective view of a twelfth embodiment;
FIG. 66 is a front elevational view of the design of FIG. 65;
FIG. 67 is a perspective view of a thirteenth embodiment of our design;
FIG. 68 is a front elevational view of the design of FIG. 67;
FIG. 69 is a rear elevational view common to the designs of FIGS. 67 and 76;
FIG. 70 is a right side elevational view common to the designs of FIGS. 67 and 76;
FIG. 71 is a left side elevational view common to the designs of FIGS. 67 and 76;
FIG. 72 is a top plan view common to the designs of FIGS. 67 and 76;
FIG. 73 is a bottom plan view common to the designs of FIGS. 67 and 76;
FIG. 74 is a cross-sectional view taken along the line 74—74 of FIG. 68 and common to the designs of FIGS. 67 and 76;
FIG. 75 is an enlarged fragmentary cross-sectional view taken from FIG. 74;
FIG. 76 is a perspective view of a fourteenth embodiment;
FIG. 77 is a front elevational view of the design of FIG. 76;
FIG. 78 is a perspective view of a fifteenth embodiment of our design;
FIG. 79 is a front elevational view of the design of FIG. 78;
FIG. 80 is a rear elevational view common to the designs of FIGS. 78 and 87;
FIG. 81 is a right side elevational view common to the designs of FIGS. 78 and 87;
FIG. 82 is a left side elevational view common to the designs of FIGS. 78 and 87;
FIG. 83 is a top plan view common to the designs of FIGS. 78 and 87;
FIG. 84 is a bottom plan view common to the designs of FIGS. 78 and 87;
FIG. 85 is a cross-sectional view taken along the line 85—85 of FIG. 79 and common to the designs of FIGS. 78 and 87;
FIG. 86 is an enlarged fragmentary cross-sectional view taken from FIG. 85;
FIG. 87 is a perspective view of a sixteenth embodiment;
FIG. 88 is a front elevational view of the design of FIG. 87;
FIG. 89 is a perspective view of a seventeenth embodiment of our design;
FIG. 90 is a front elevational view of the design of FIG. 89;
FIG. 91 is a rear elevational view common to the designs of FIGS. 89 and 98;
FIG. 92 is a right side elevational view common to the designs of FIGS. 89 and 98;
FIG. 93 is a left side elevational view common to the designs of FIGS. 89 and 98;
FIG. 94 is a top plan view common to the designs of FIGS. 89 and 98;
FIG. 95 is a bottom plan view common to the designs of FIGS. 89 and 98;
FIG. 96 is a cross-sectional view taken along the line 96—96 of FIG. 90 and common to the designs of FIGS. 89 and 98;
FIG. 97 is an enlarged fragmentary cross-sectional view taken from FIG. 96;
FIG. 98 is a perspective view of an eighteenth embodiment;
FIG. 99 is a front elevational view of the design of FIG. 98;
FIG. 100 is a perspective view of a nineteenth embodiment of our design;
FIG. 101 is a front elevational view of the design of FIG. 100;
FIG. 102 is a rear elevational view common to the designs of FIGS. 100 and 109;

FIG. 103 is a right side elevational view common to the designs of FIGS. 100 and 109;
FIG. 104 is a left side elevational view common to the designs of FIGS. 100 and 109;
FIG. 105 is a top plan view common to the designs of FIGS. 100 and 109;
FIG. 106 is a bottom plan view common to the designs of FIGS. 100 and 109;
FIG. 107 is a cross-sectional view taken along the line 107—107 of FIG. 101 and common to the designs of FIGS. 100 and 109;
FIG. 108 is an enlarged fragmentary cross-sectional view taken from FIG. 107;
FIG. 109 is a perspective view of a twentieth embodiment;
FIG. 110 is a front elevational view of the design of FIG. 109;
FIG. 111 is a perspective view of a twenty-first embodiment of our design;
FIG. 112 is a front elevational view of the design of FIG. 111;
FIG. 113 is a rear elevational view common to the designs of FIGS. 111 and 120;
FIG. 114 is a right side elevational view common to the designs of FIGS. 111 and 120;
FIG. 115 is a left side elevational view common to the designs of FIGS. 111 and 120;
FIG. 116 is a top plan view common to the designs of FIGS. 111 and 120;
FIG. 117 is a bottom plan view common to the designs of FIGS. 111 and 120;
FIG. 118 is a cross-sectional view taken along the line 118—118 of FIG. 112 and common to the designs of FIGS. 111 and 120;
FIG. 119 is an enlarged fragmentary cross-sectional view taken from FIG. 118;
FIG. 120 is a perspective view of a twenty-second embodiment;
FIG. 121 is a front elevational view of the design of FIG. 120;
FIG. 122 is a perspective view of a twenty-third embodiment of our design;
FIG. 123 is a front elevational view of the design of FIG. 122;
FIG. 124 is a rear elevational view common to the designs of FIGS. 122 and 131;
FIG. 125 is a right side elevational view common to the designs of FIGS. 122 and 131;
FIG. 126 is a left side elevational view common to the designs of FIGS. 122 and 131;
FIG. 127 is a top plan view common to the designs of FIGS. 122 and 131;
FIG. 128 is a bottom plan view common to the designs of FIGS. 122 and 131;
FIG. 129 is a cross-sectional view taken along the line 129—129 of FIG. 123 and common to the designs of FIGS. 122 and 131;
FIG. 130 is an enlarged fragmentary cross-sectional view taken from FIG. 129;
FIG. 131 is a perspective view of a twenty-fourth embodiment;
FIG. 132 is a front elevational view of the design of FIG. 131;
FIG. 133 is a perspective view of a twenty-fifth embodiment of our design;
FIG. 134 is a front elevational view of the design of FIG. 133;
FIG. 135 is a rear elevational view common to the designs of FIGS. 133 and 142;
FIG. 136 is a right side elevational view common to the designs of FIGS. 133 and 142;

FIG. 137 is a left side elevational view common to the designs of FIGS. 133 and 142;
FIG. 138 is a top plan view common to the designs of FIGS. 133 and 142;
FIG. 139 is a bottom plan view common to the designs of FIGS. 133 and 142;
FIG. 140 is a cross-sectional view taken along the line 140—140 of FIG. 134 and common to the designs of FIGS. 133 and 142;
FIG. 141 is an enlarged fragmentary cross-sectional view taken from FIG. 140;
FIG. 142 is a perspective view of a twenty-sixth embodiment;
FIG. 143 is a front elevational view of the design of FIG. 142;
FIG. 144 is a perspective view of a twenty-seventh embodiment of our design;
FIG. 145 is a front elevational view of the design of FIG. 144;
FIG. 146 is a rear elevational view common to the designs of FIGS. 144 and 153;
FIG. 147 is a right side elevational view common to the designs of FIGS. 144 and 153;
FIG. 148 is a left side elevational view common to the designs of FIGS. 144 and 153;
FIG. 149 is a top plan view common to the designs of FIGS. 144 and 153;
FIG. 150 is a bottom plan view common to the designs of FIGS. 144 and 153;
FIG. 151 is a cross-sectional view taken along the line 151—151 of FIG. 145 and common to the designs of FIGS. 144 and 153;
FIG. 152 is an enlarged fragmentary cross-sectional view taken from FIG. 151;
FIG. 153 is a perspective view of a twenty-eighth embodiment;
FIG. 154 is a front elevational view of the design of FIG. 153;
FIG. 155 is a perspective view of a twenty-ninth embodiment of our design;
FIG. 156 is a front elevational view of the design of FIG. 155;
FIG. 157 is a rear elevational view common to the designs of FIGS. 155 and 164;
FIG. 158 is a right side elevational view common to the designs of FIGS. 155 and 164;
FIG. 159 is a left side elevational view common to the designs of FIGS. 155 and 164;
FIG. 160 is a top plan view common to the designs of FIGS. 155 and 164;
FIG. 161 is a bottom plan view common to the designs of FIGS. 155 and 164;
FIG. 162 is a cross-sectional view taken along the line 162—162 of FIG. 156 and common to the designs of FIGS. 155 and 164;
FIG. 163 is an enlarged fragmentary cross-sectional view taken from FIG. 162;
FIG. 164 is a perspective view of a thirtieth embodiment;
FIG. 165 is a front elevational view of the design of FIG. 164;
FIG. 166 is a perspective view of a thirty-first embodiment of our design;
FIG. 167 is a front elevational view of the design of FIG. 166;
FIG. 168 is a rear elevational view common to the designs of FIGS. 166 and 175;
FIG. 169 is a right side elevational view common to the designs of FIGS. 166 and 175;
FIG. 170 is a left side elevational view common to the designs of FIGS. 166 and 175;
FIG. 171 is a top plan view common to the designs of FIGS. 166 and 175;

FIG. 172 is a bottom plan view common to the designs of FIGS. 166 and 175;

FIG. 173 is a cross-sectional view taken along the line 173—173 of FIG. 167 and common to the designs of FIGS. 166 and 175;

FIG. 174 is an enlarged fragmentary cross-sectional view taken from FIG. 173;

FIG. 175 is a perspective view of a thirty-second embodiment;

FIG. 176 is a front elevational view of the design of FIG. 175;

FIG. 177 is a perspective view of a thirty-third embodiment of our design;

FIG. 178 is a front elevational view of the design of FIG. 177;

FIG. 179 is a rear elevational view common to the designs of FIGS. 177 and 186;

FIG. 180 is a right side elevational view common to the designs of FIGS. 177 and 186;

FIG. 181 is a left side elevational view common to the designs of FIGS. 177 and 186;

FIG. 182 is a top plan view common to the designs of FIGS. 177 and 186;

FIG. 183 is a bottom plan view common to the designs of FIGS. 177 and 186;

FIG. 184 is a cross-sectional view taken along the line 183—183 of FIG. 178 and common to the designs of FIGS. 177 and 186;

FIG. 185 is an enlarged fragmentary cross-sectional view taken from FIG. 184;

FIG. 186 is a perspective view of a thirty-fourth embodiment;

FIG. 187 is a front elevational view of the design of FIG. 186;

FIG. 188 is a perspective view of a thirty-fifth embodiment of our design;

FIG. 189 is a front elevational view of the design of FIG. 188;

FIG. 190 is a rear elevational view common to the designs of FIGS. 188 and 197;

FIG. 191 is a right side elevational view common to the designs of FIGS. 188 and 197;

FIG. 192 is a left side elevational view common to the designs of FIGS. 188 and 197;

FIG. 193 is a top plan view common to the designs of FIGS. 188 and 197;

FIG. 194 is a bottom plan view common to the designs of FIGS. 188 and 197;

FIG. 195 is a cross-sectional view taken along the line 195—195 of FIG. 189 and common to the designs of FIGS. 188 and 197;

FIG. 196 is an enlarged fragmentary cross-sectional view taken from FIG. 195;

FIG. 197 is a perspective view of a thirty-sixth embodiment;

FIG. 198 is a front elevational view of the design of FIG. 197;

FIG. 199 is a perspective view of a thirty-seventh embodiment of our design;

FIG. 200 is a front elevational view of the design of FIG. 199;

FIG. 201 is a rear elevational view common to the designs of FIGS. 199 and 208;

FIG. 202 is a right side elevational view common to the designs of FIGS. 199 and 208;

FIG. 203 is a left side elevational view common to the designs of FIGS. 199 and 208;

FIG. 204 is a top plan view common to the designs of FIGS. 199 and 208;

FIG. 205 is a bottom plan view common to the designs of FIGS. 199 and 208;

FIG. 206 is a cross-sectional view taken along the line 206—206 of FIG. 200 and common to the designs of FIGS. 199 and 208;

FIG. 207 is an enlarged fragmentary cross-sectional view taken from FIG. 206;

FIG. 208 is a perspective view of a thirty-eighth embodiment; and,

FIG. 209 is a front elevational view of the design of FIG. 208.

The broken lines are for illustrative purposes only and form no part of the claimed design.

1 Claim, 133 Drawing Sheets

Fig. 1

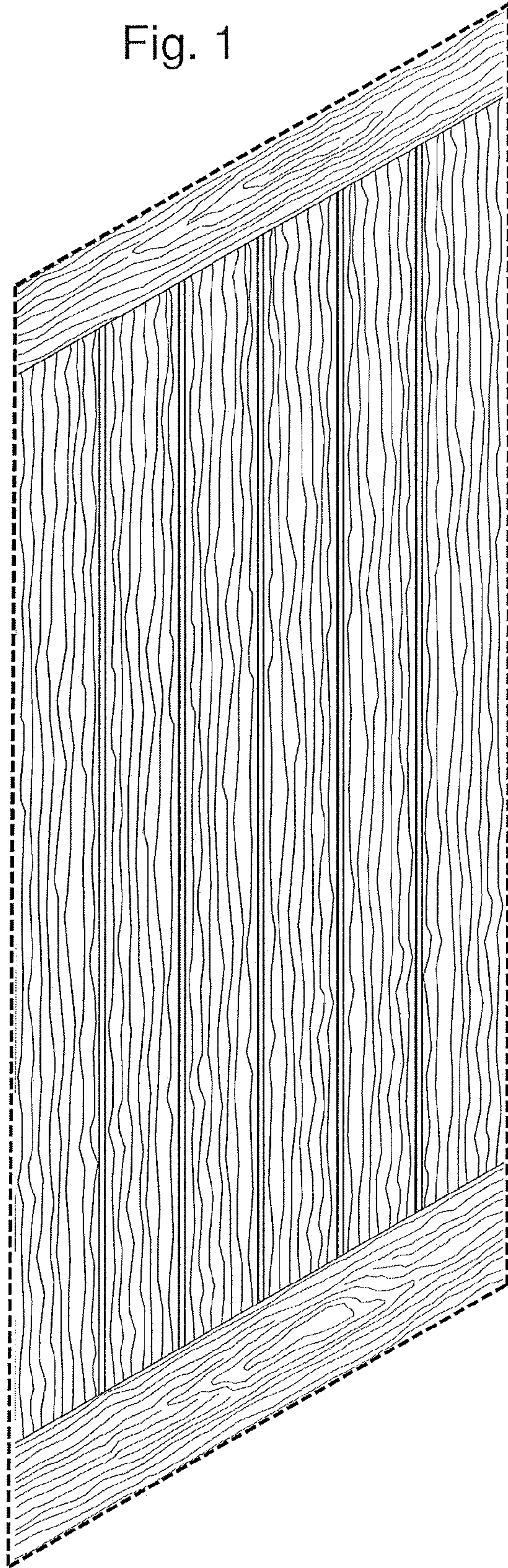

Fig. 2

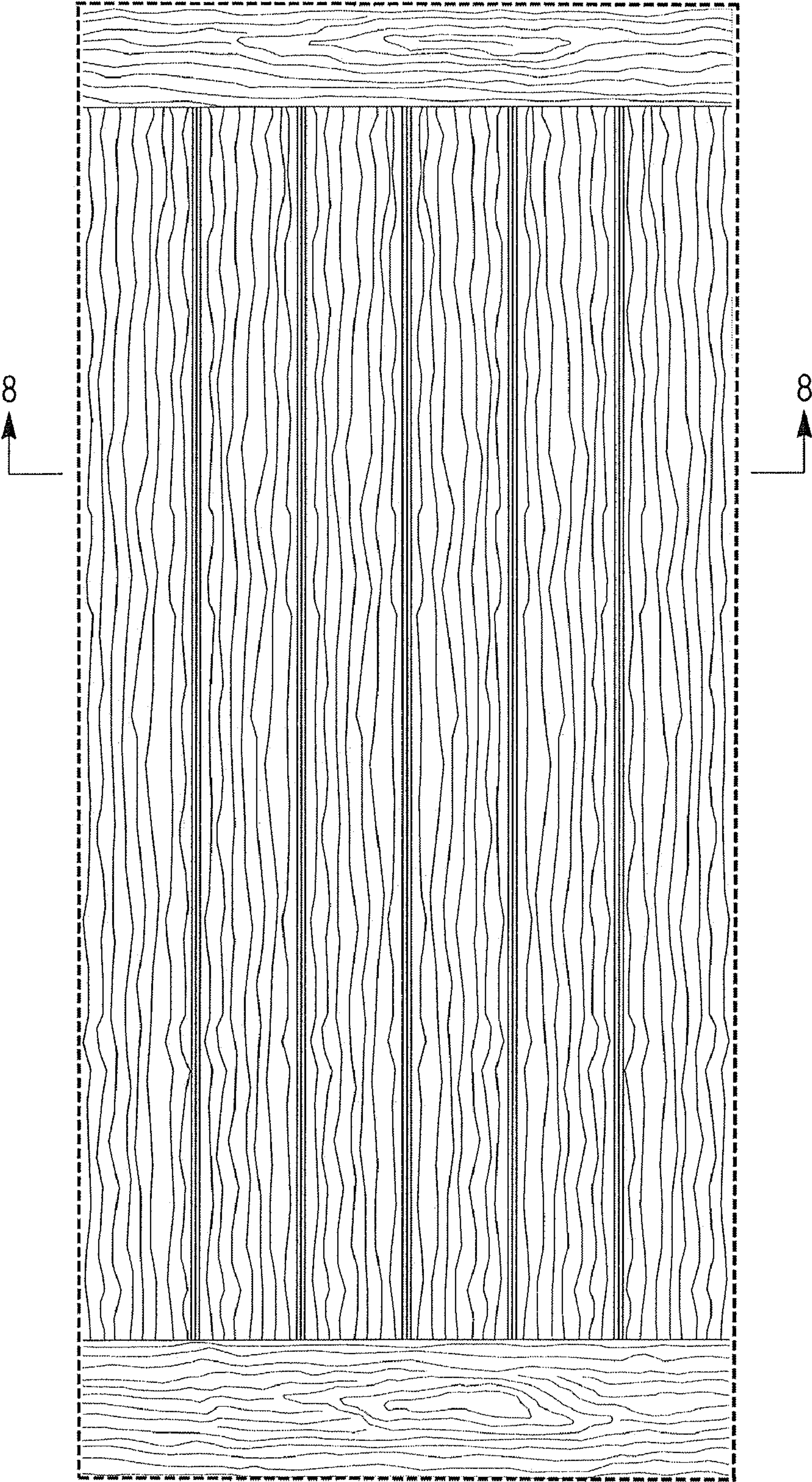

Fig. 3

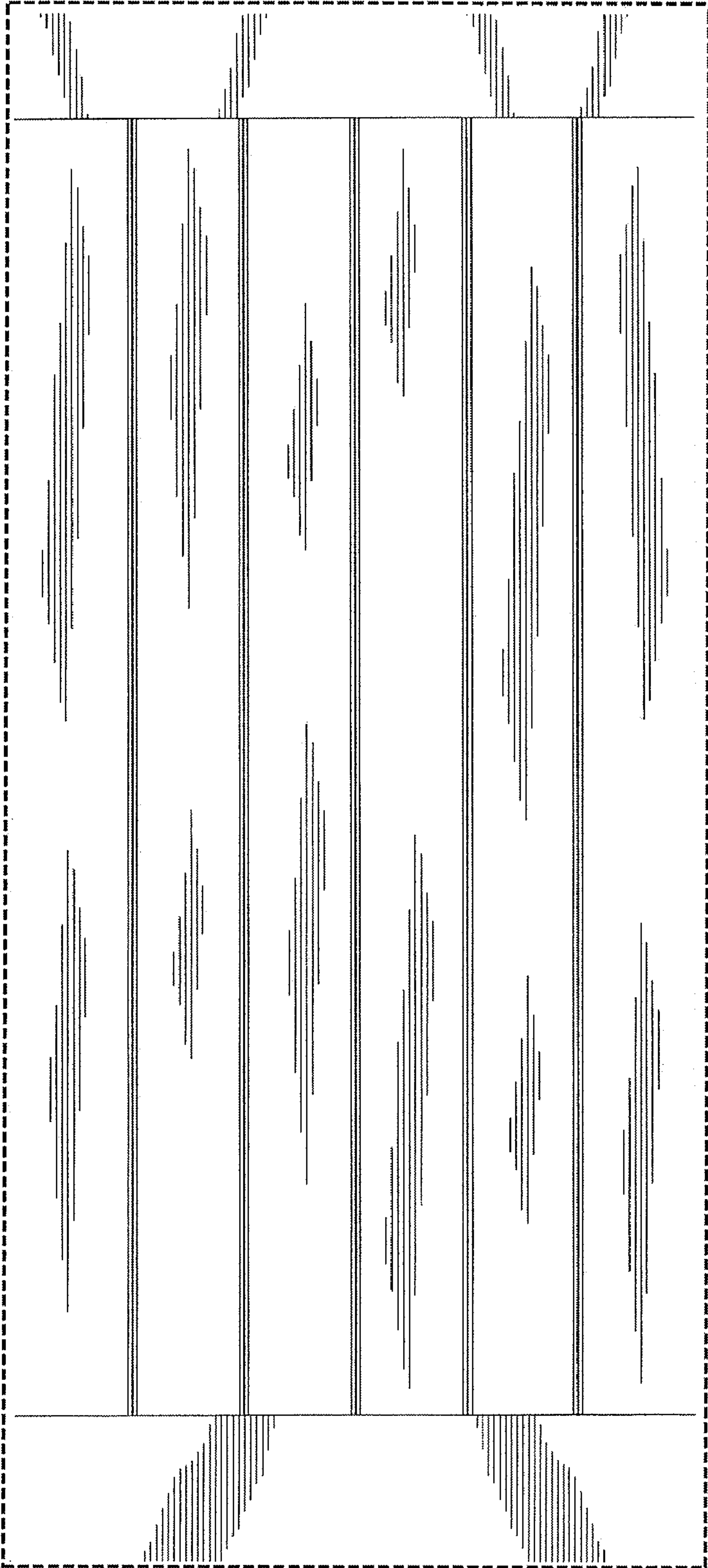

Fig. 4



Fig. 5



Fig. 6

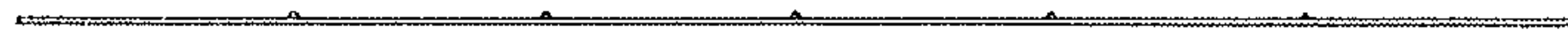

Fig. 7

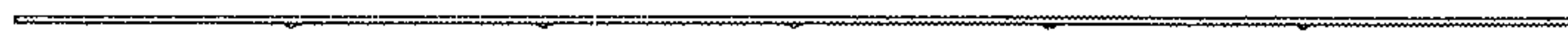

Fig. 8

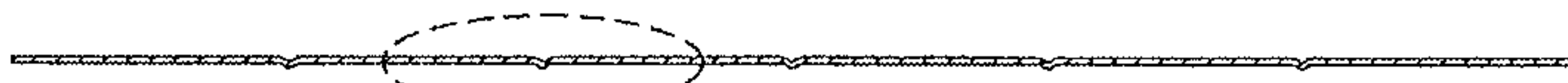

Fig. 9

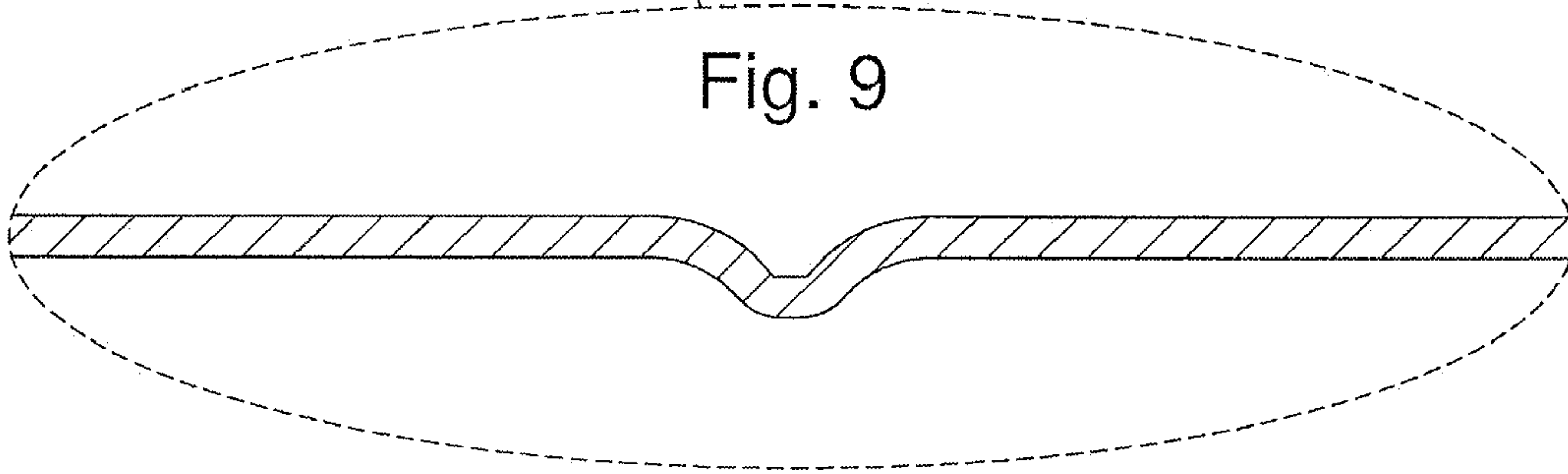

Fig. 10

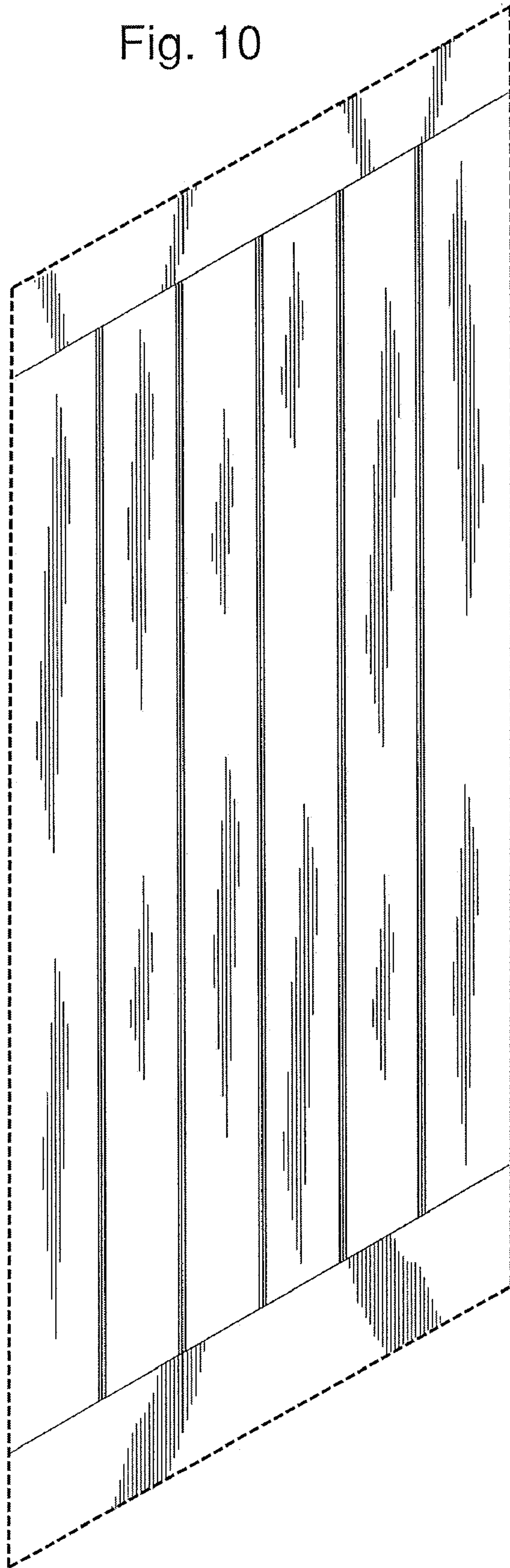

Fig. 11

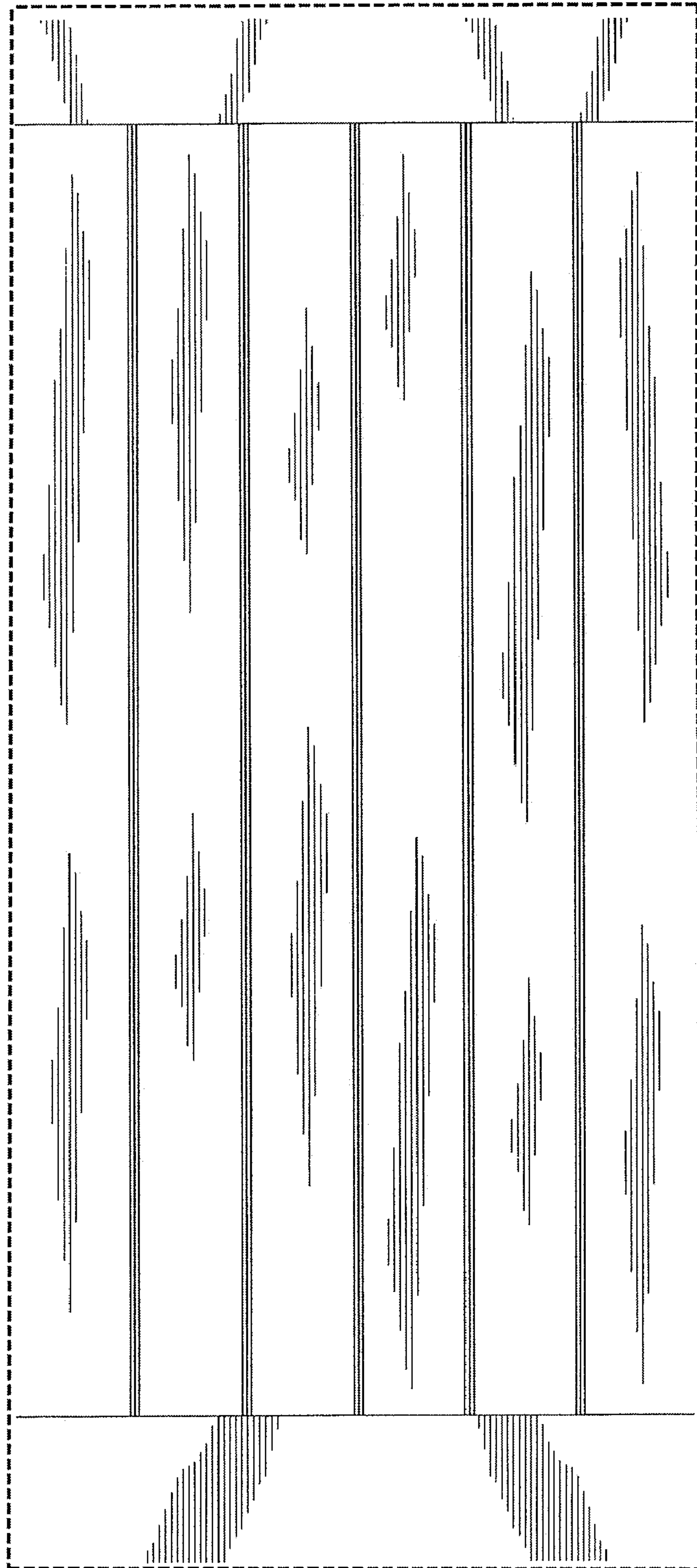

Fig. 12

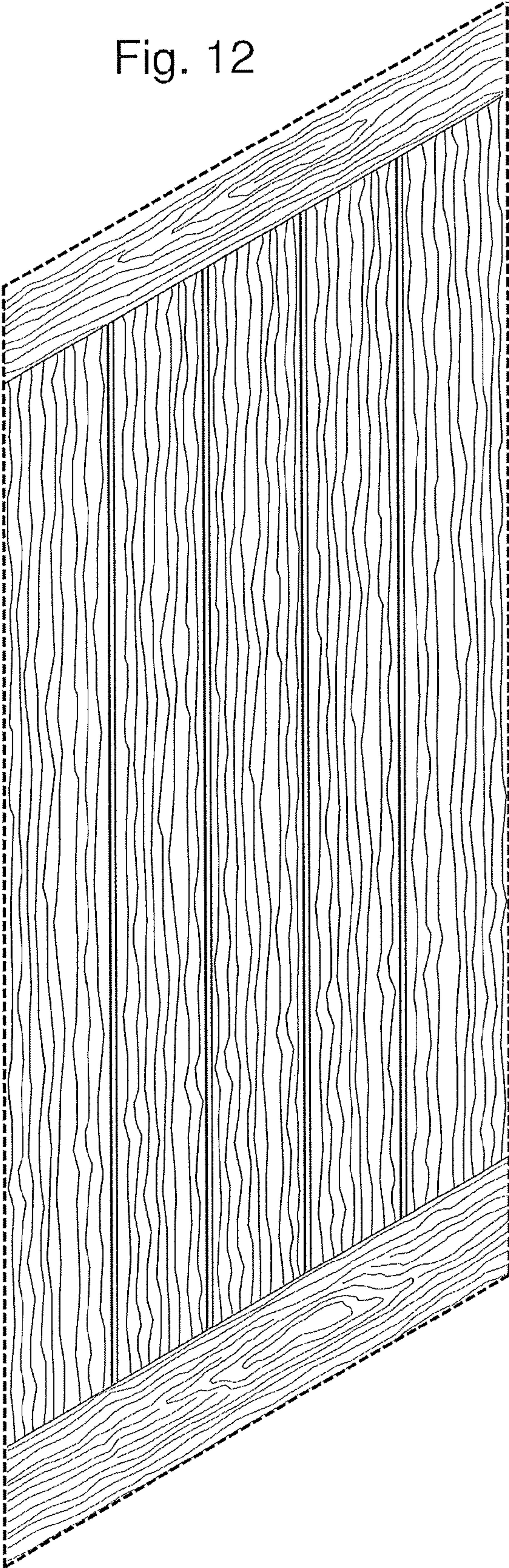

Fig. 13

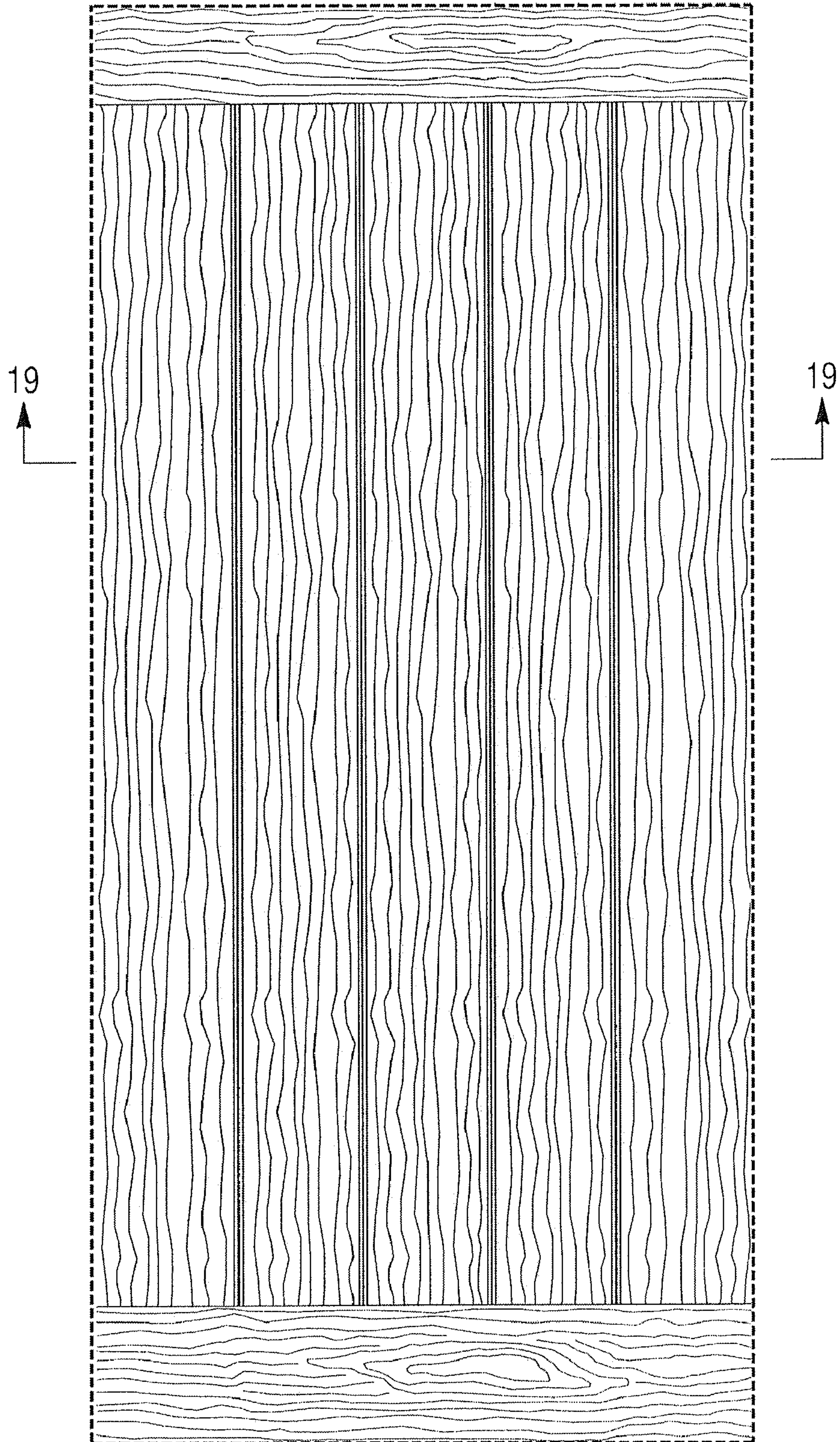

Fig. 14

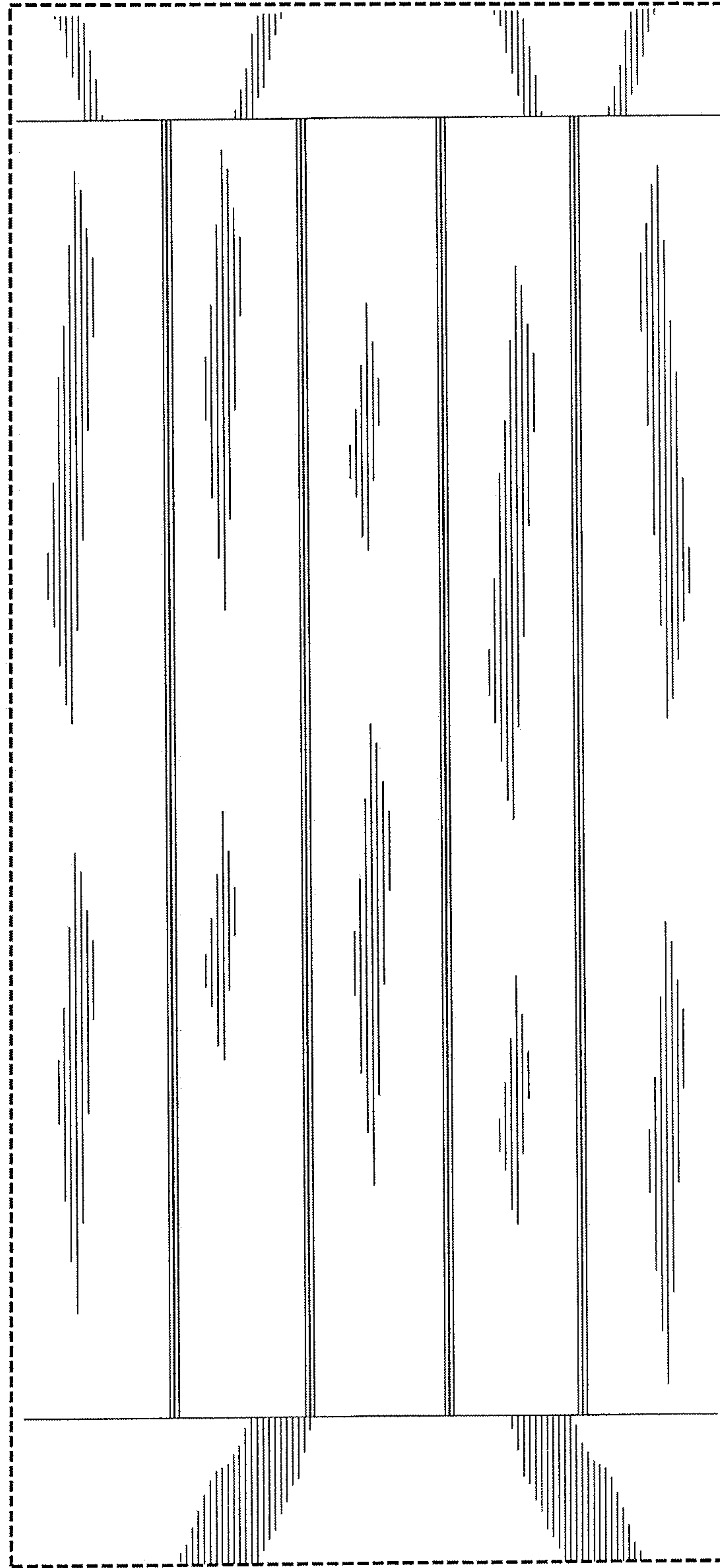

Fig. 15



Fig. 16



Fig. 17

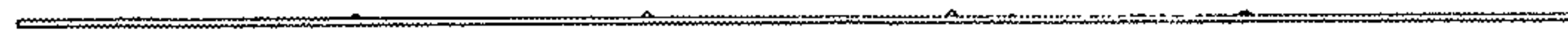

Fig. 18

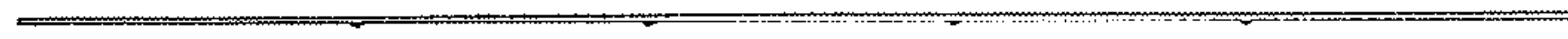

Fig. 19

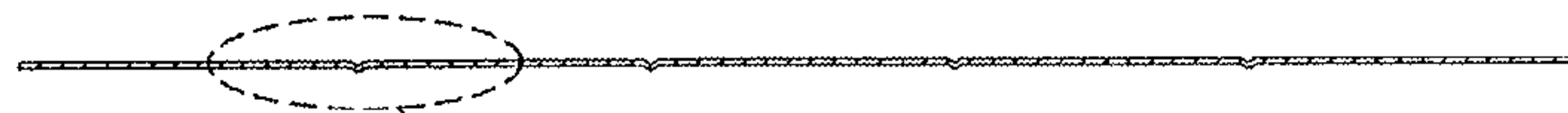

Fig. 20

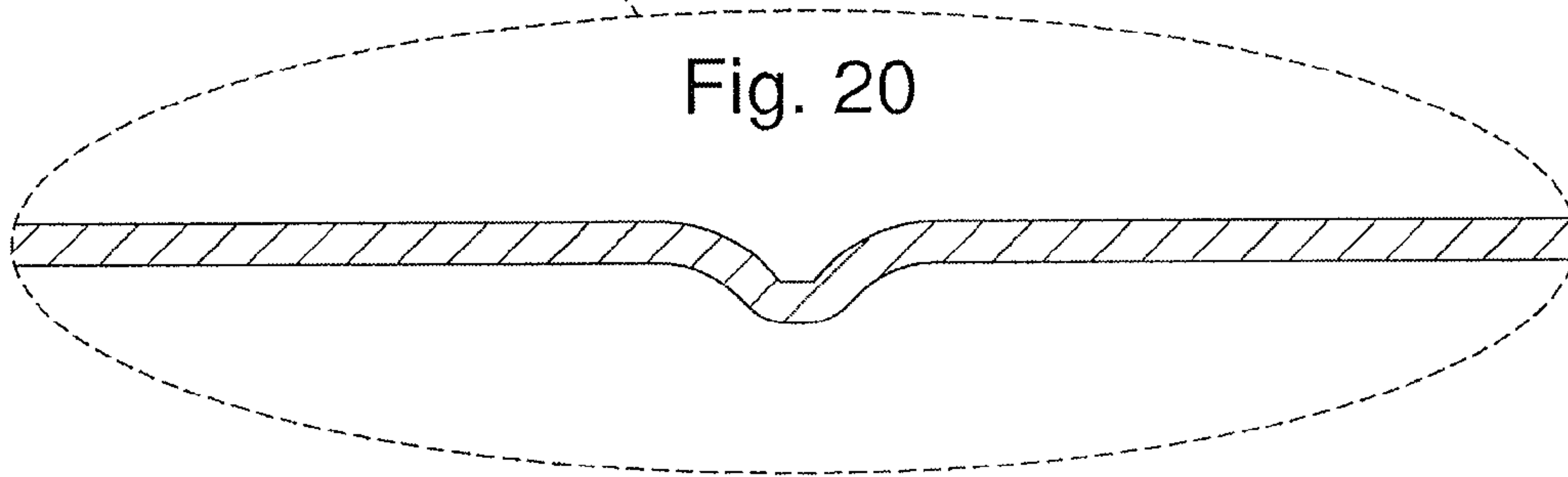

Fig. 21

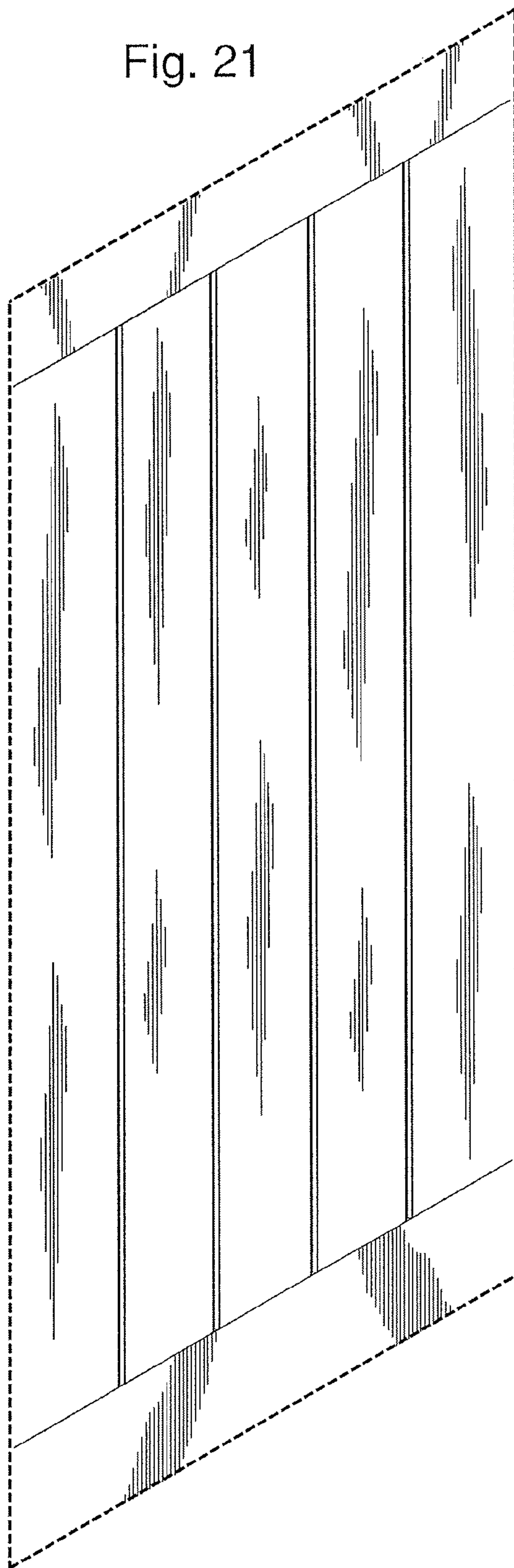

Fig. 22

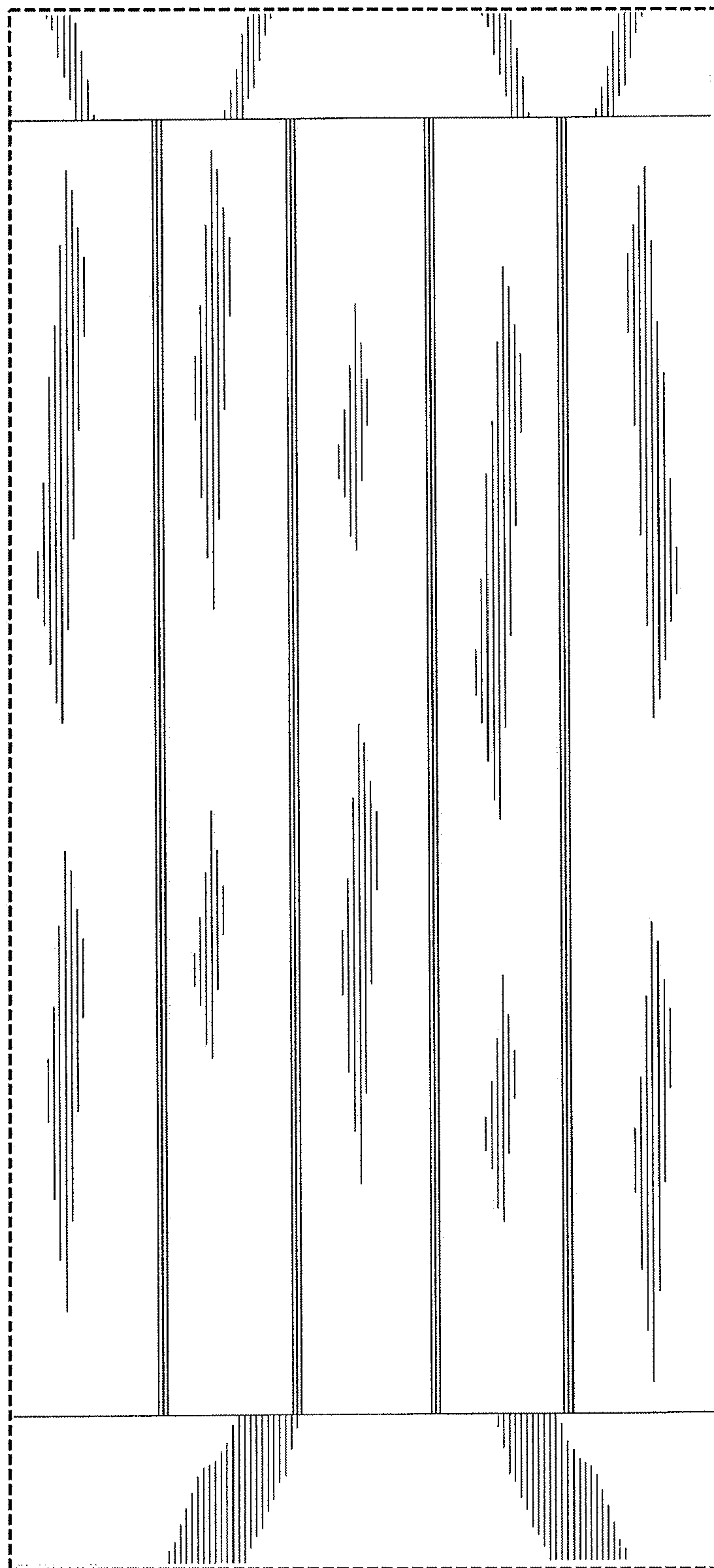

Fig. 23

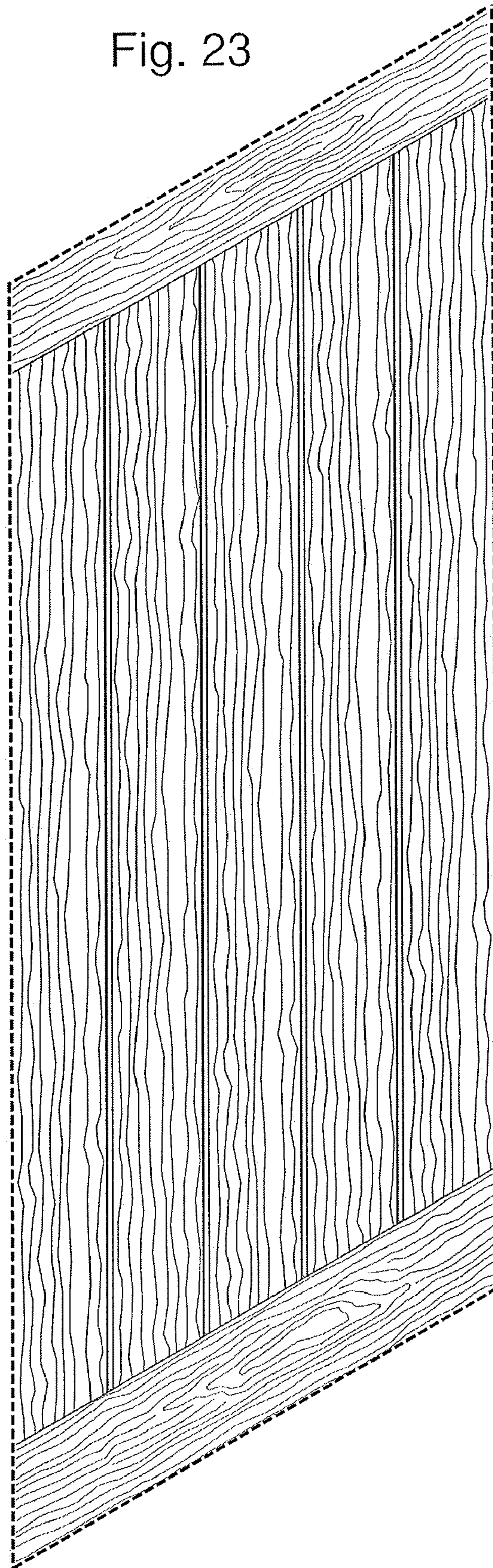

Fig. 24

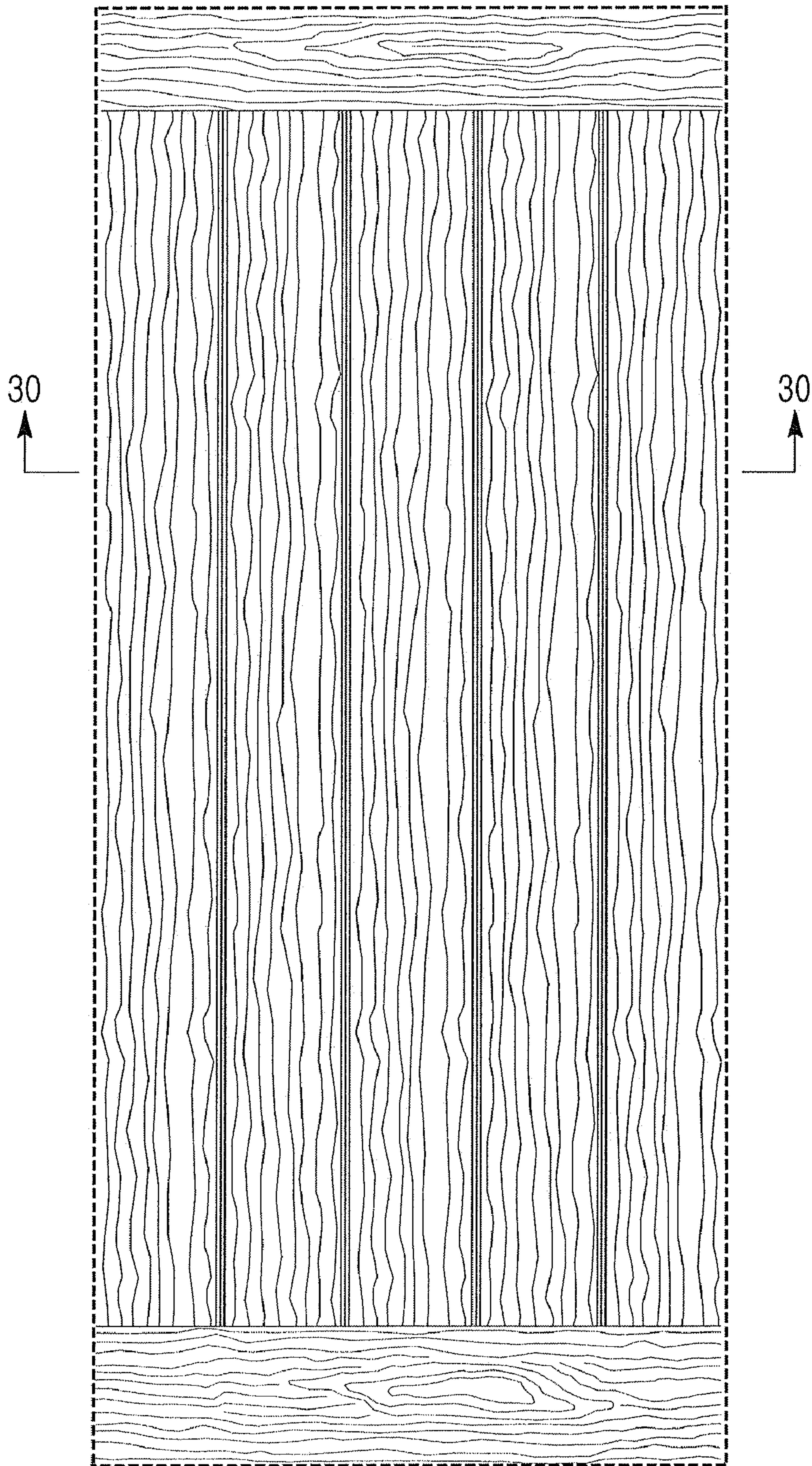

Fig. 25

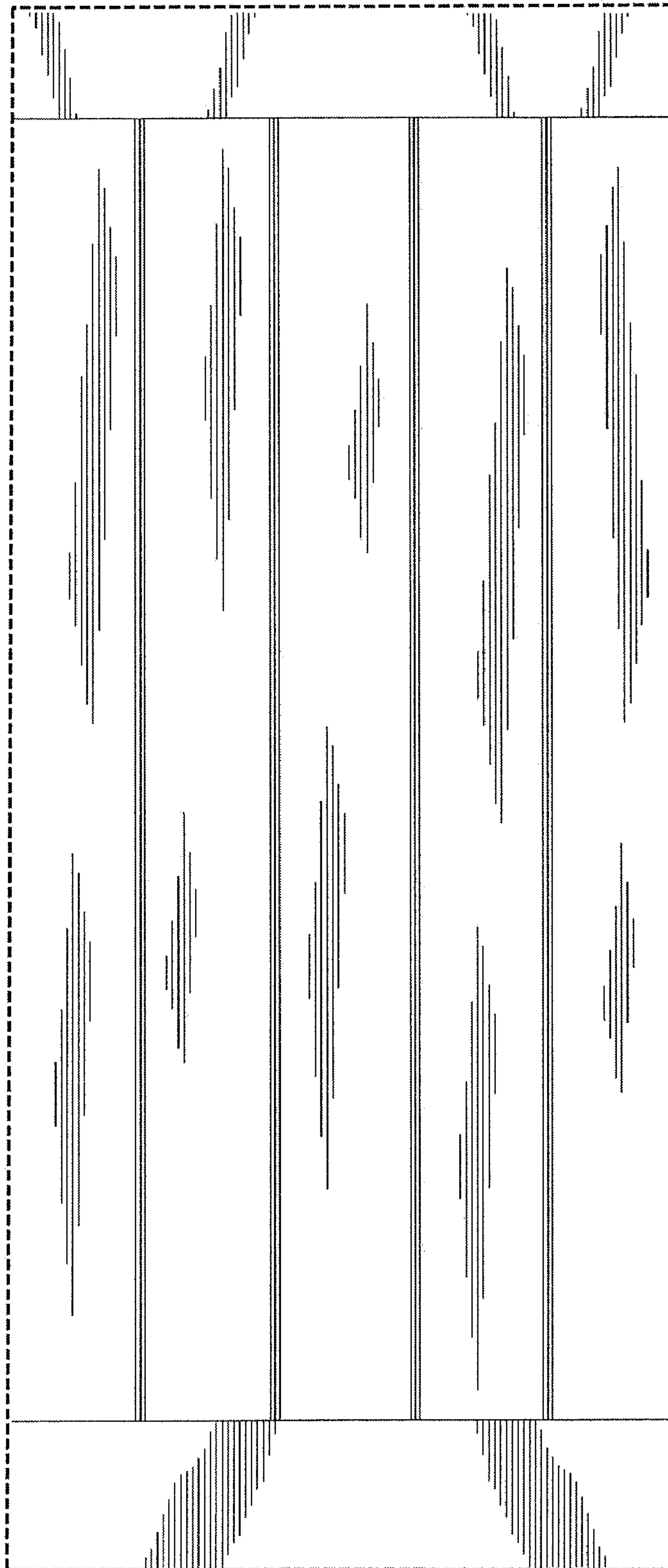

Fig. 26



Fig. 27



Fig. 28

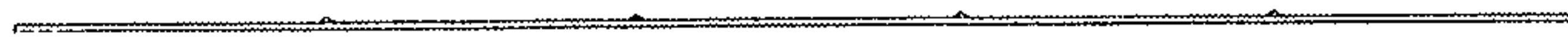

Fig. 29

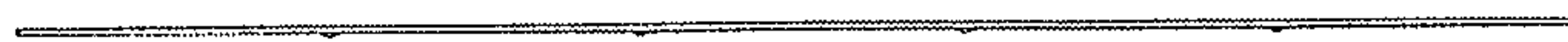

Fig. 30

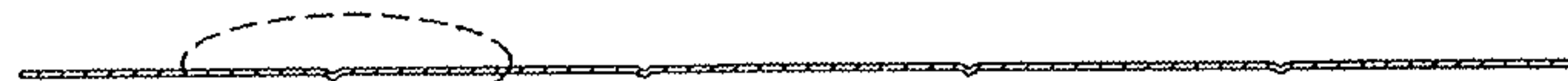

Fig. 31

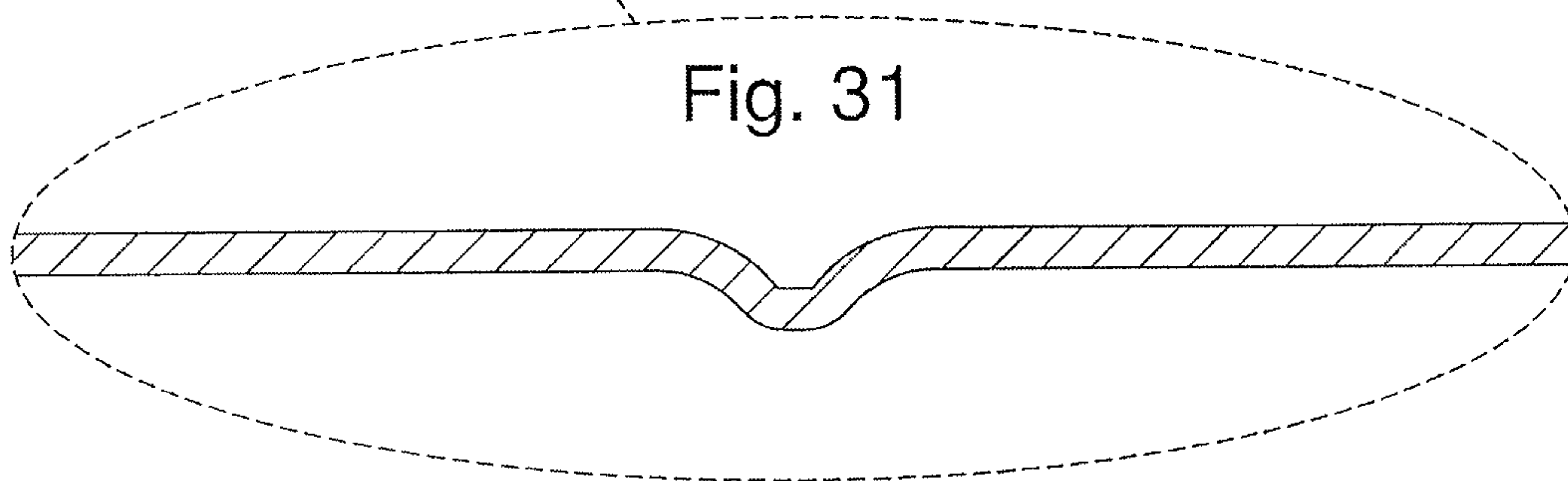

Fig. 32

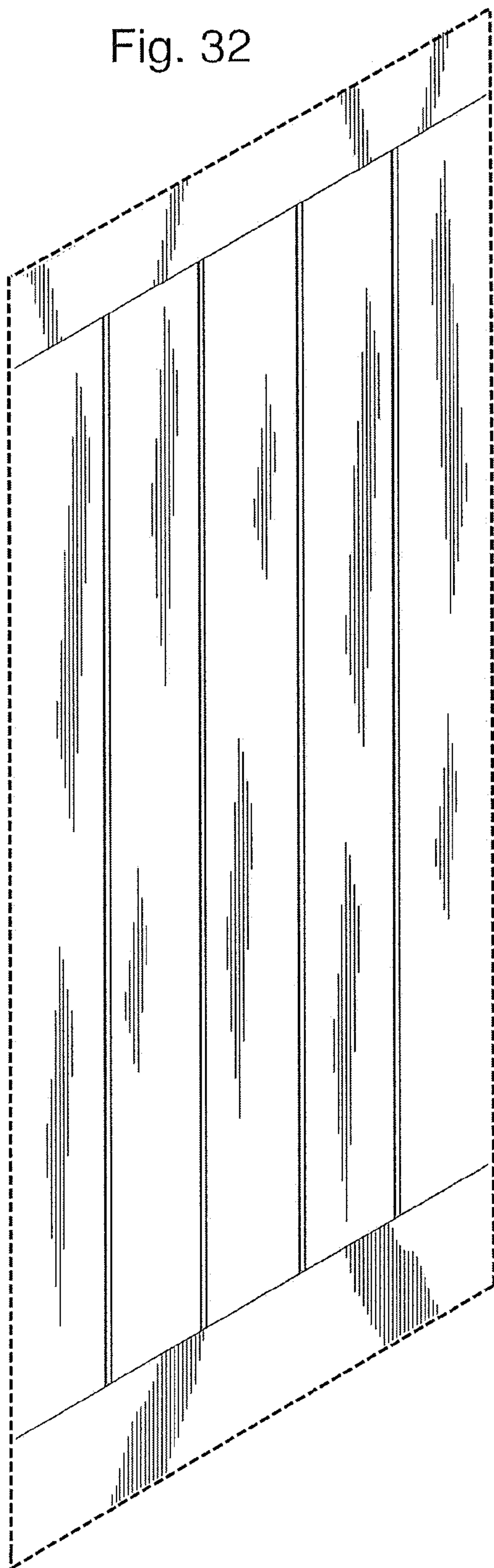

Fig. 33

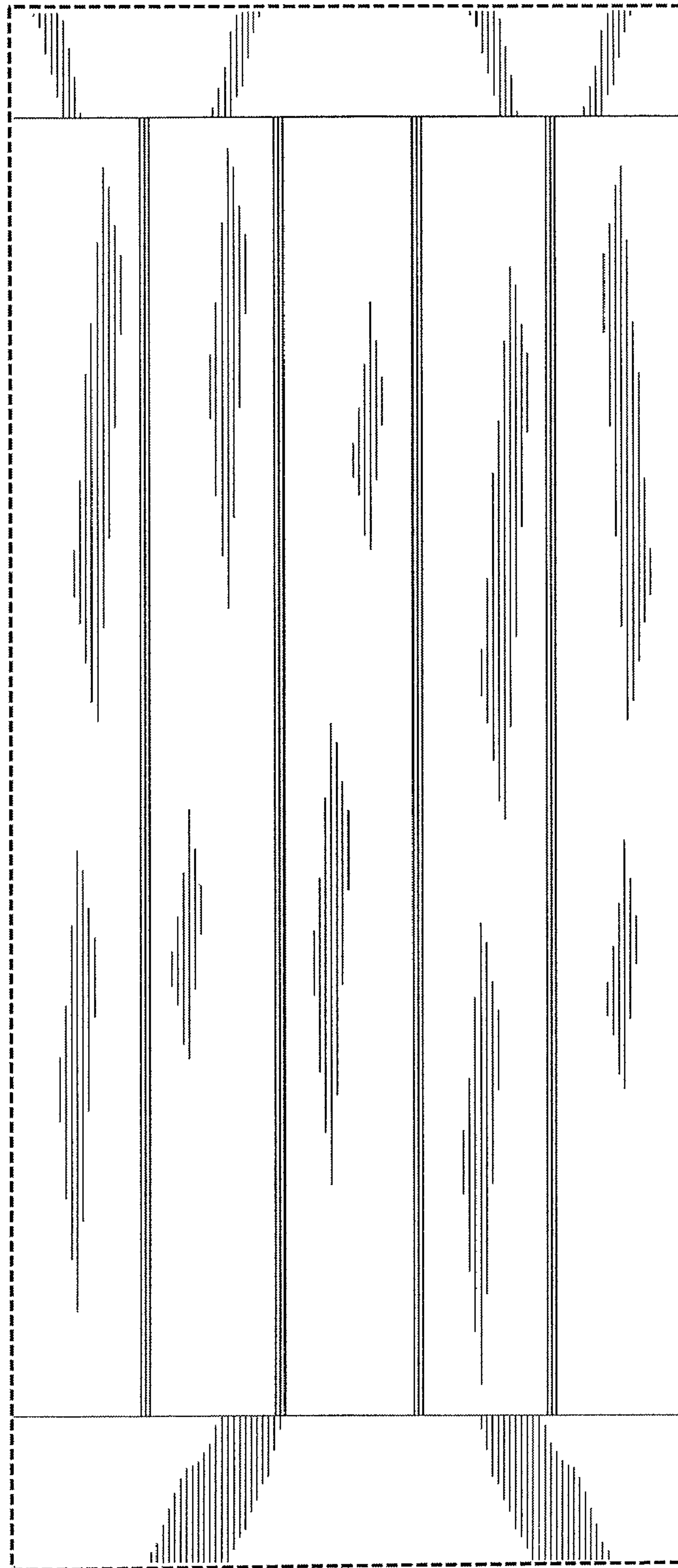

Fig. 34

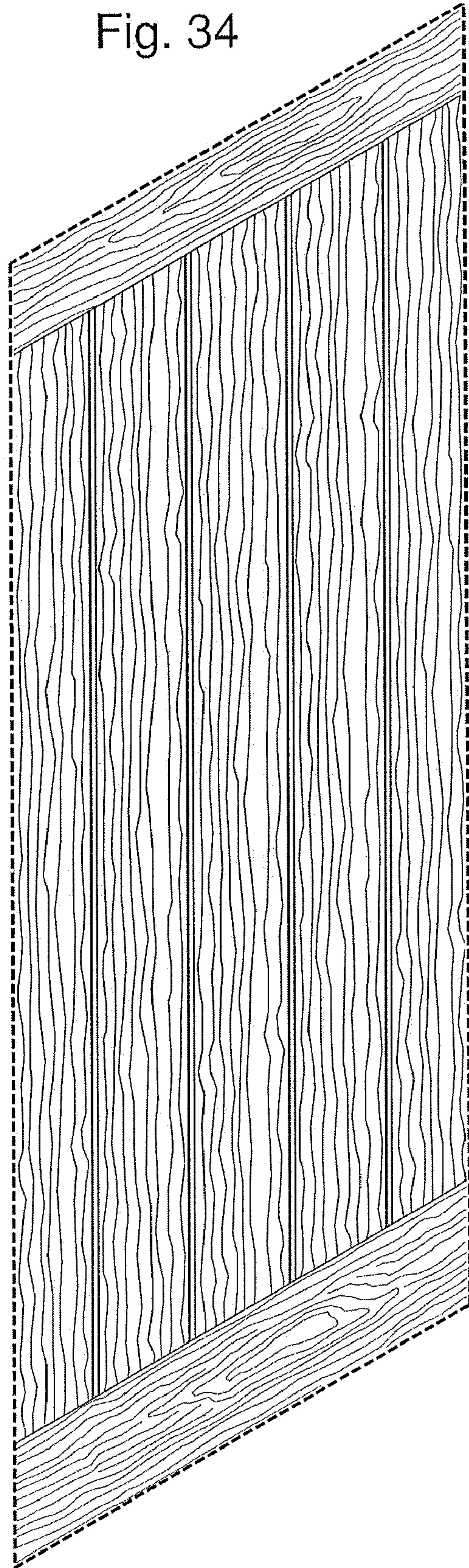

Fig. 35

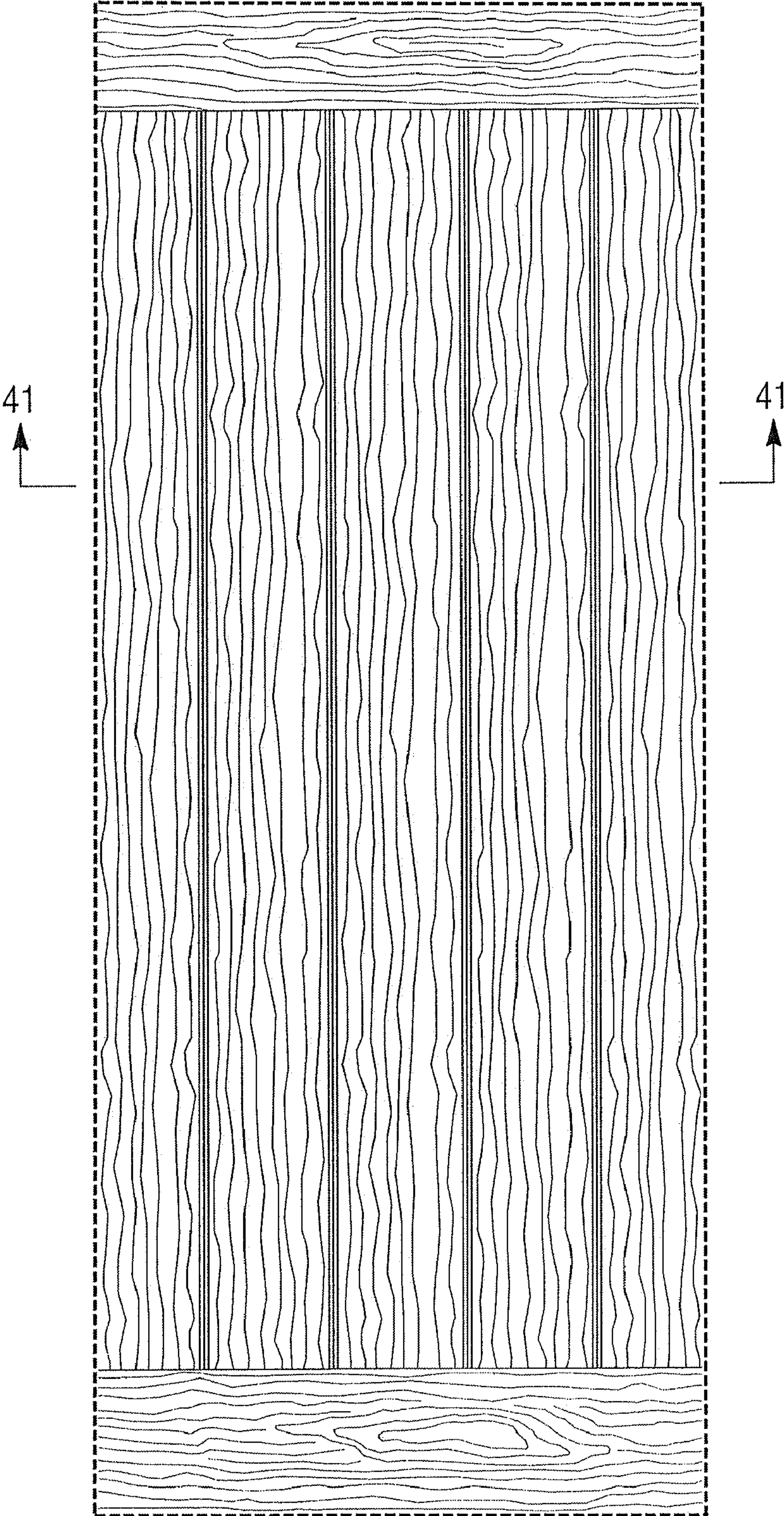

Fig. 36

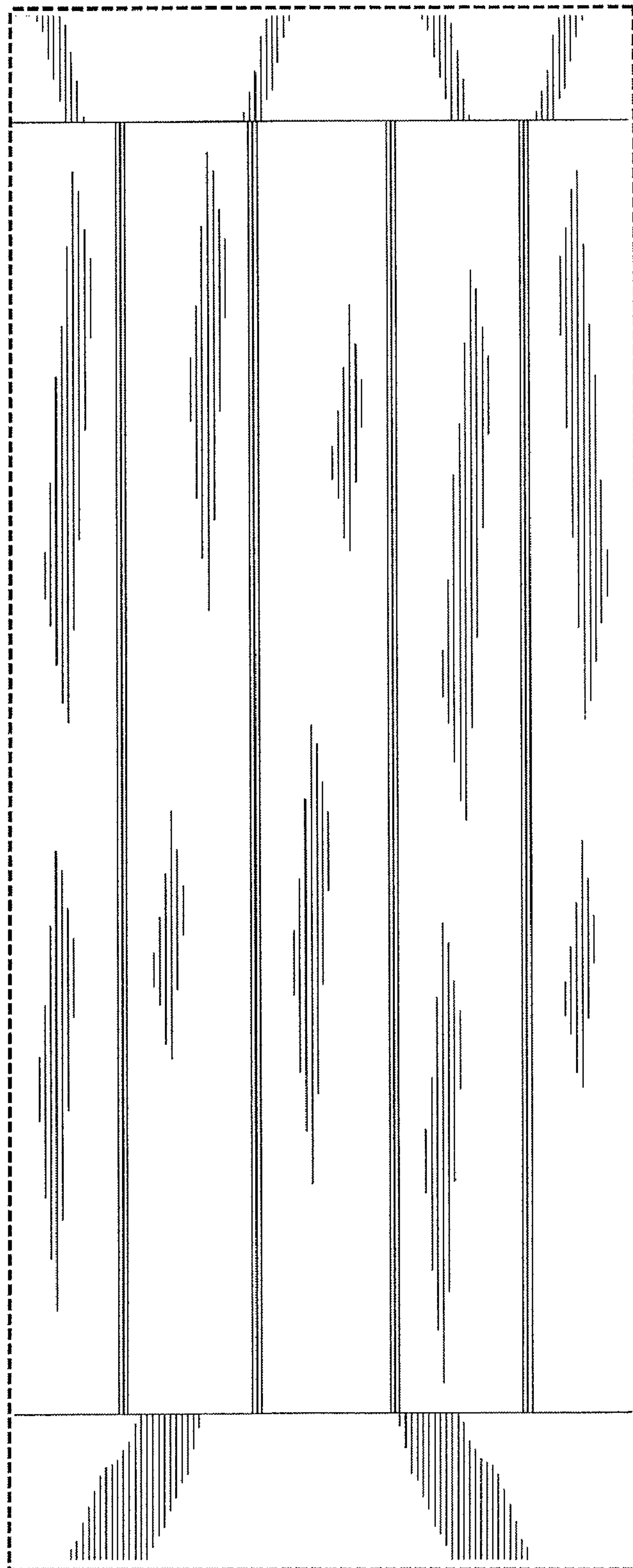

Fig. 37



Fig. 38



Fig. 39

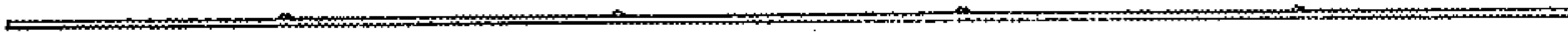

Fig. 40

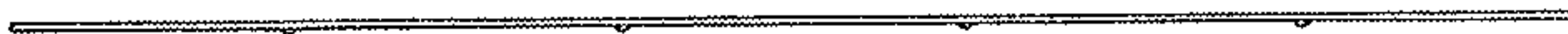

Fig. 41



Fig. 42

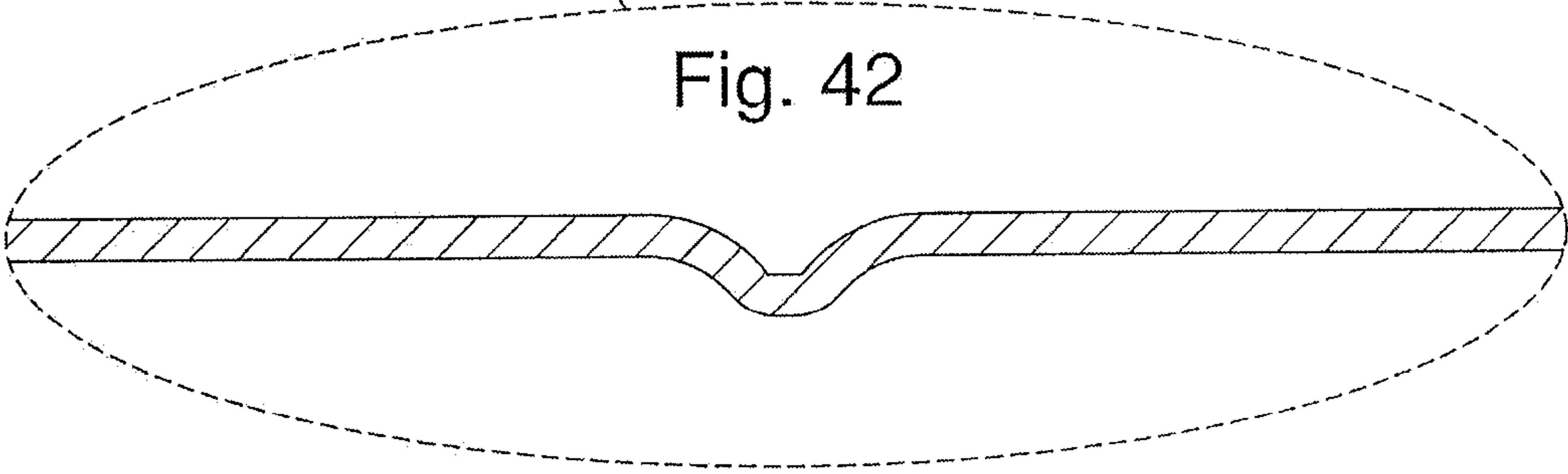

Fig. 43

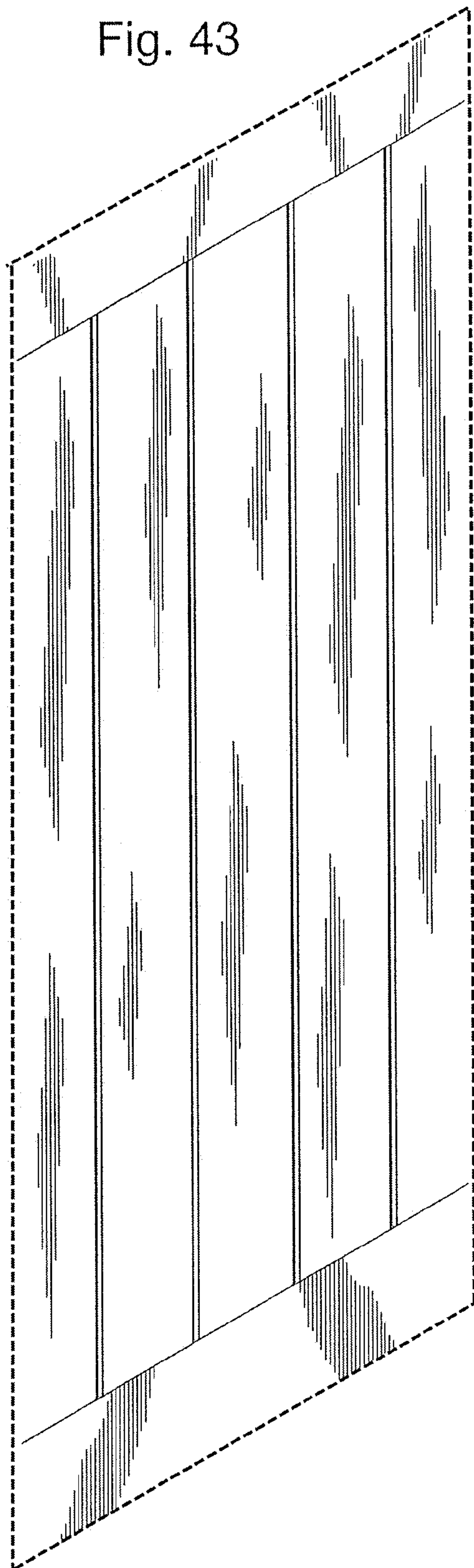

Fig. 44

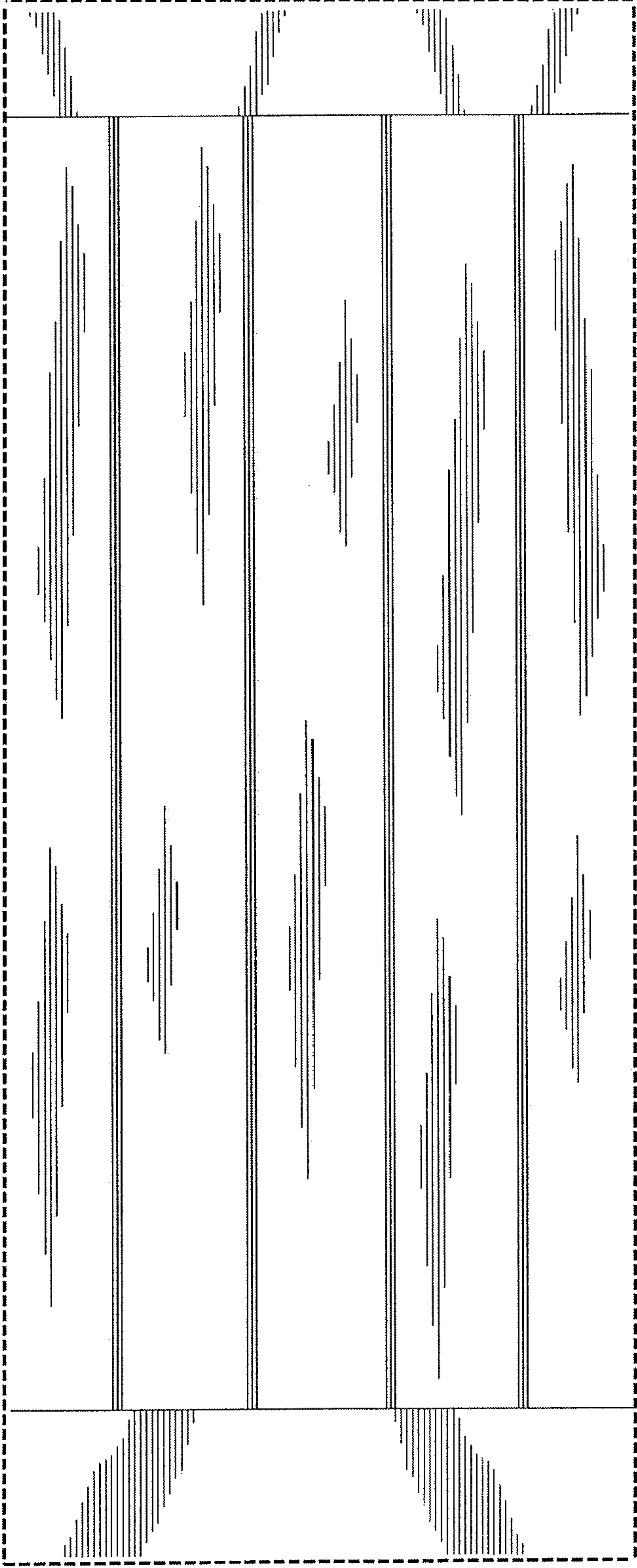

Fig. 45

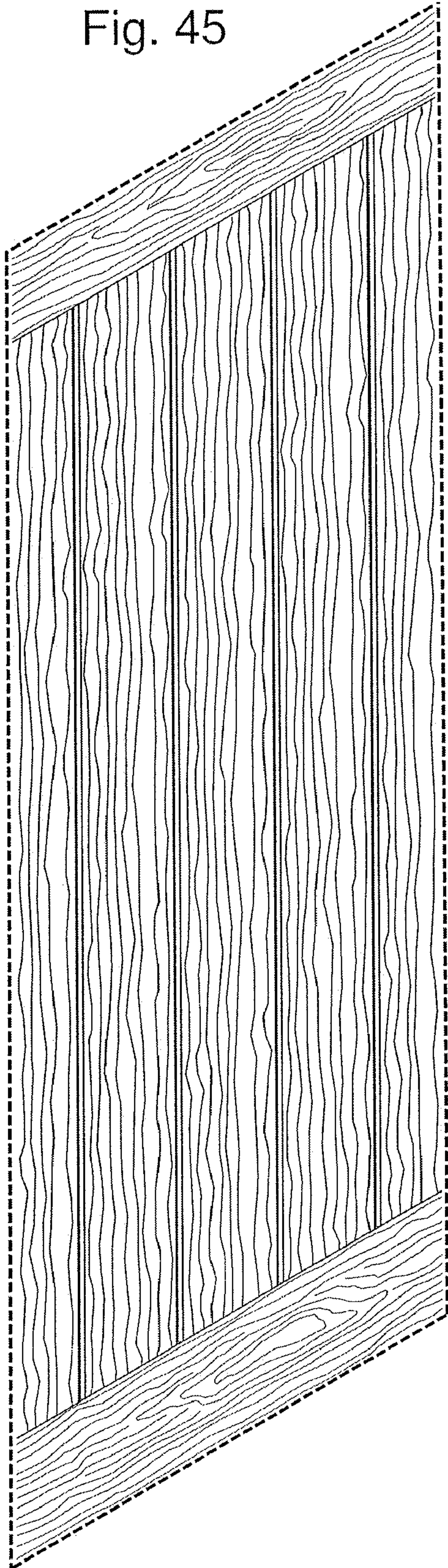

Fig. 46

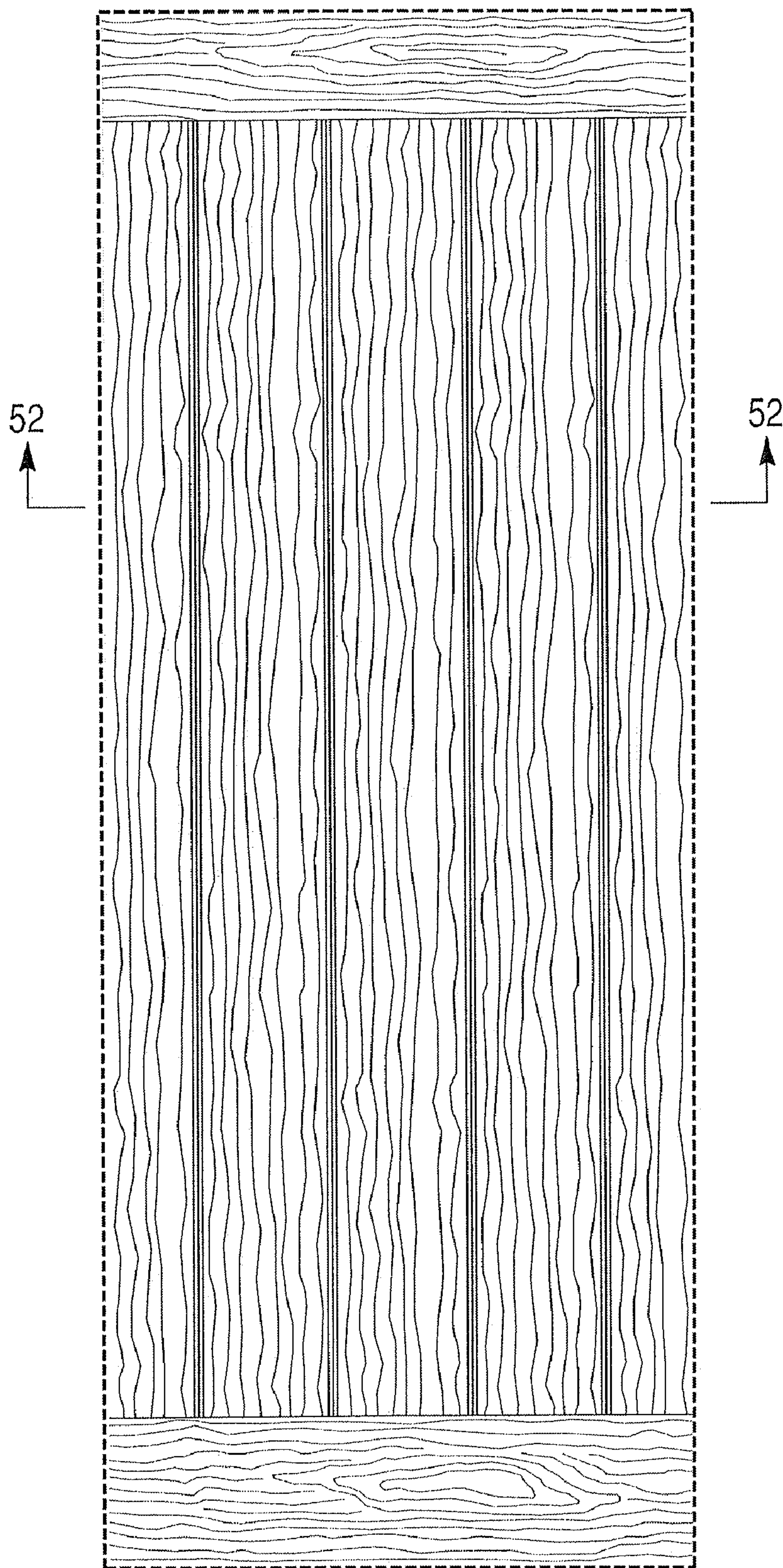

Fig. 47

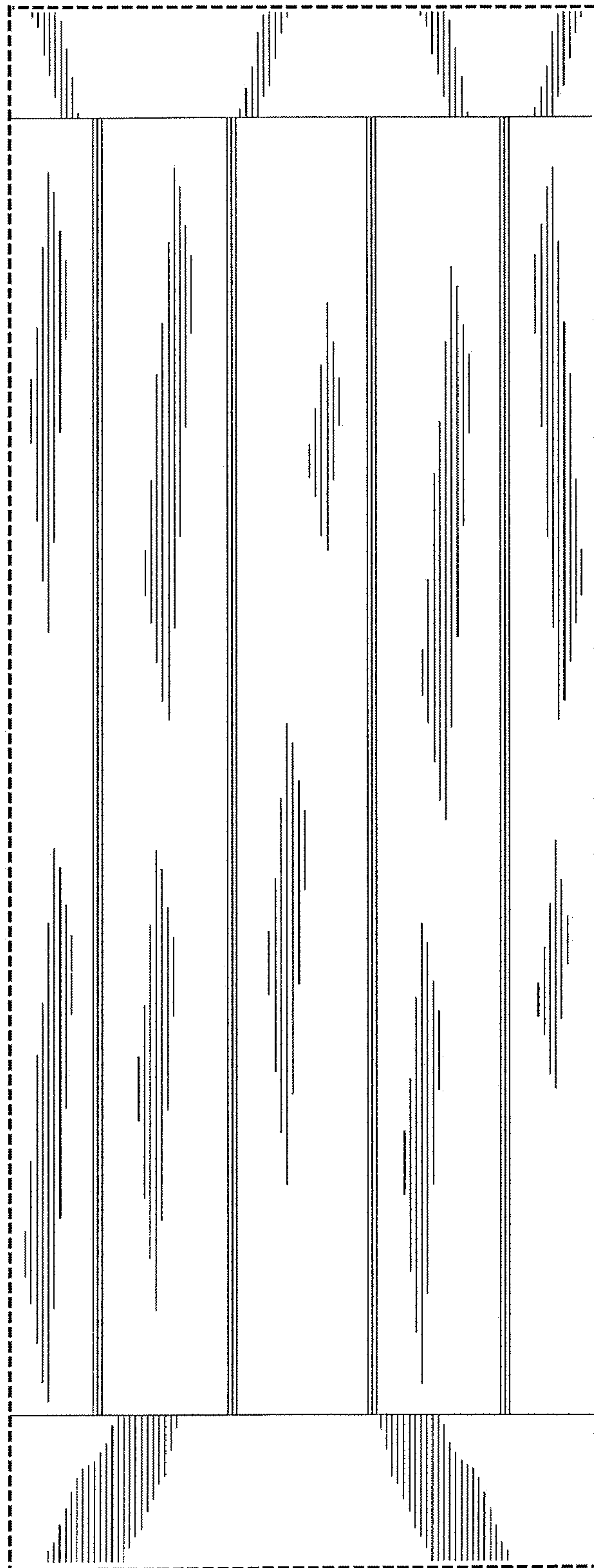

Fig. 48



Fig. 49



Fig. 50

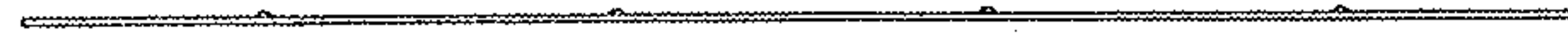

Fig. 51



Fig. 52

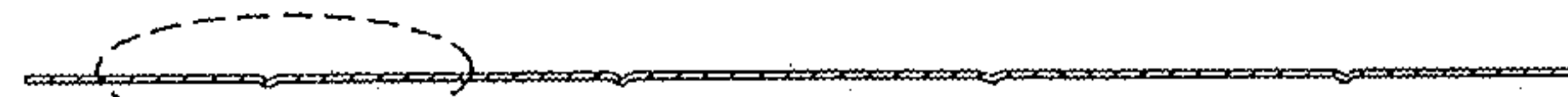

Fig. 53

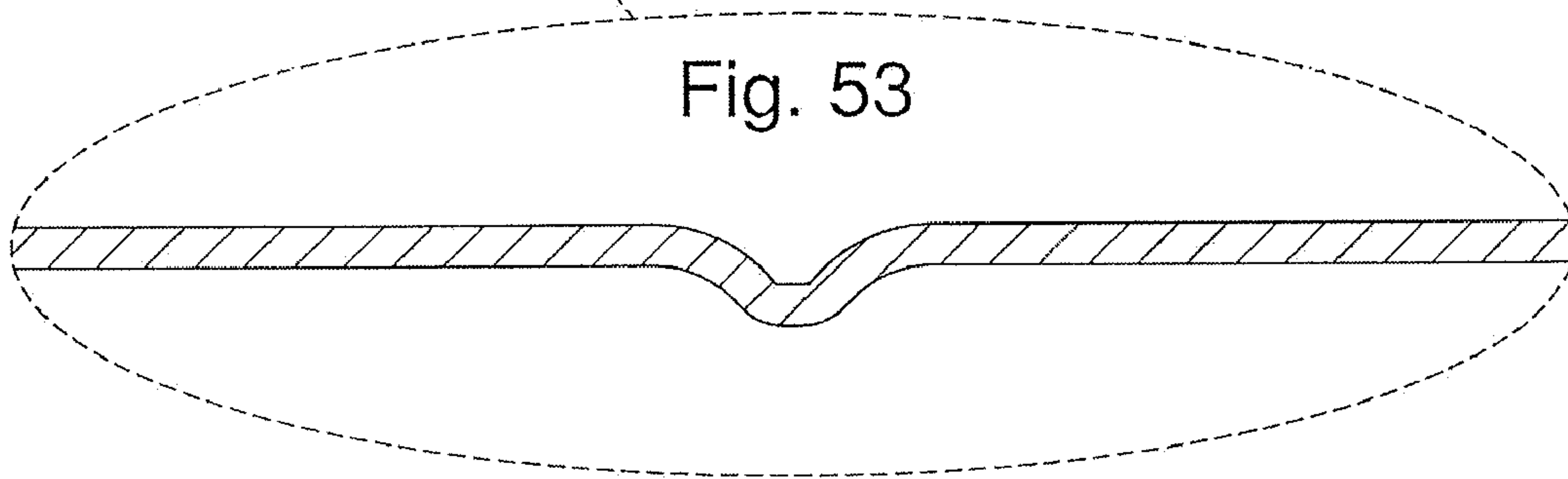

Fig. 54

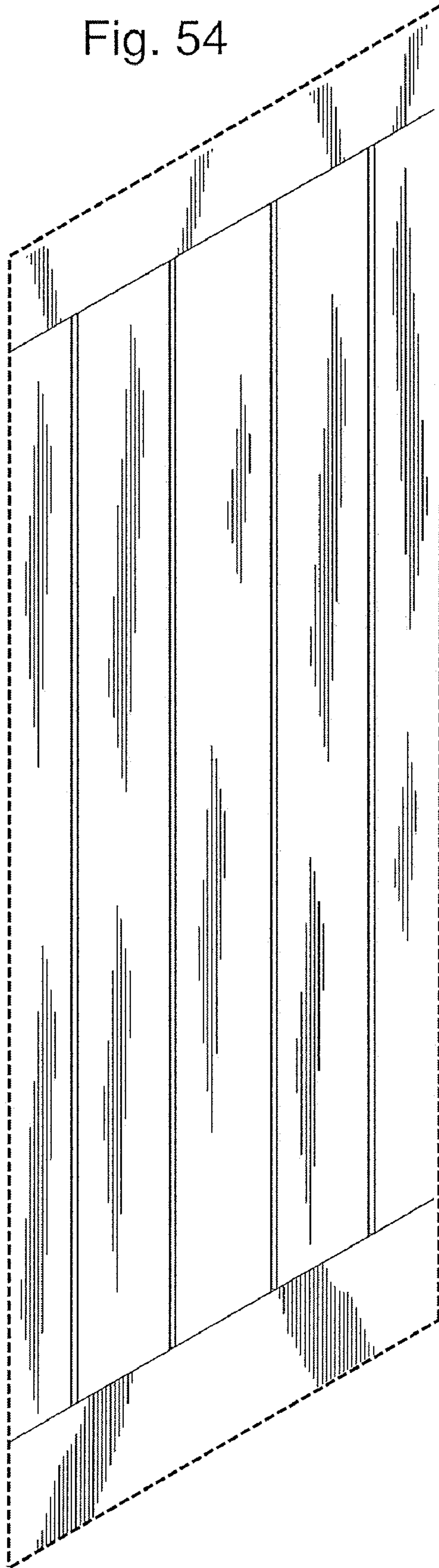

Fig. 55

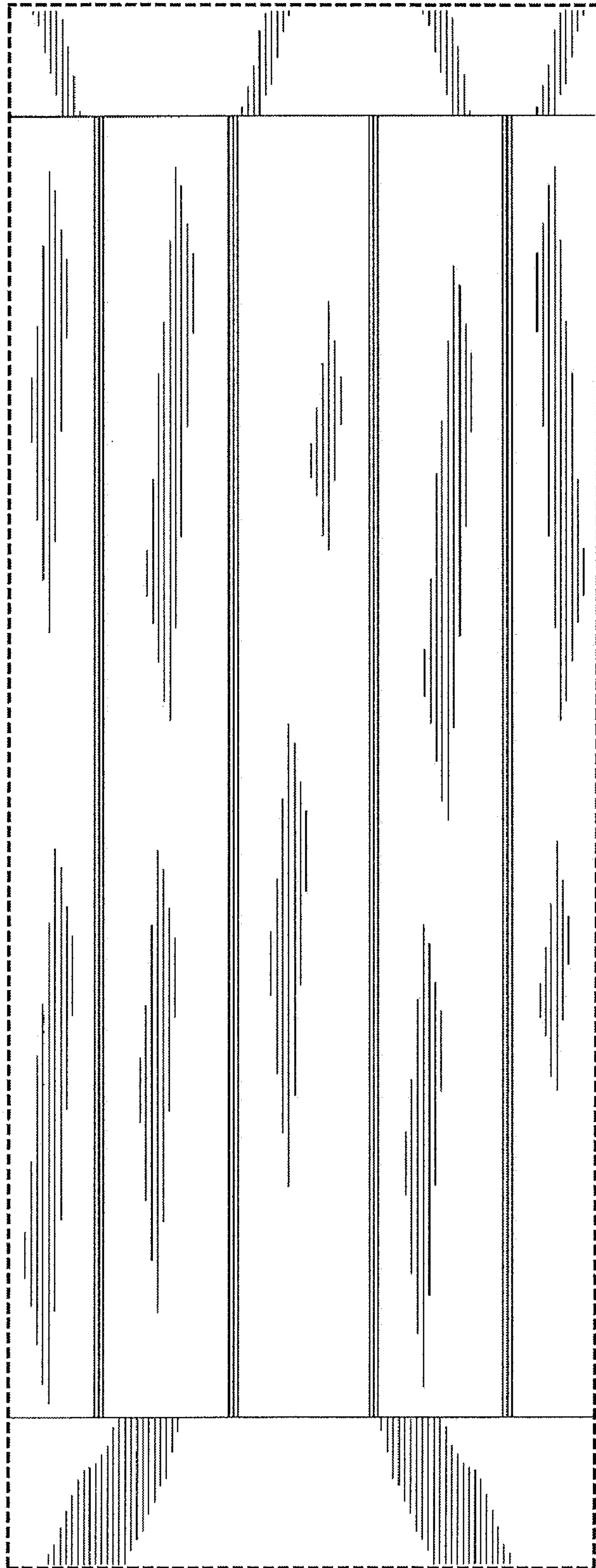

Fig. 56

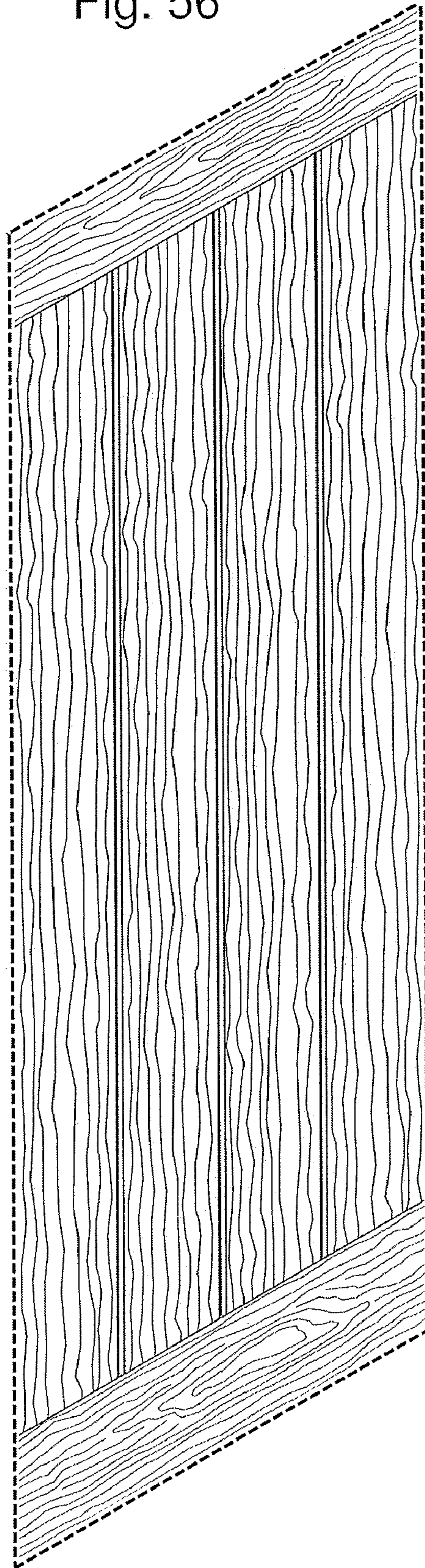

Fig. 57

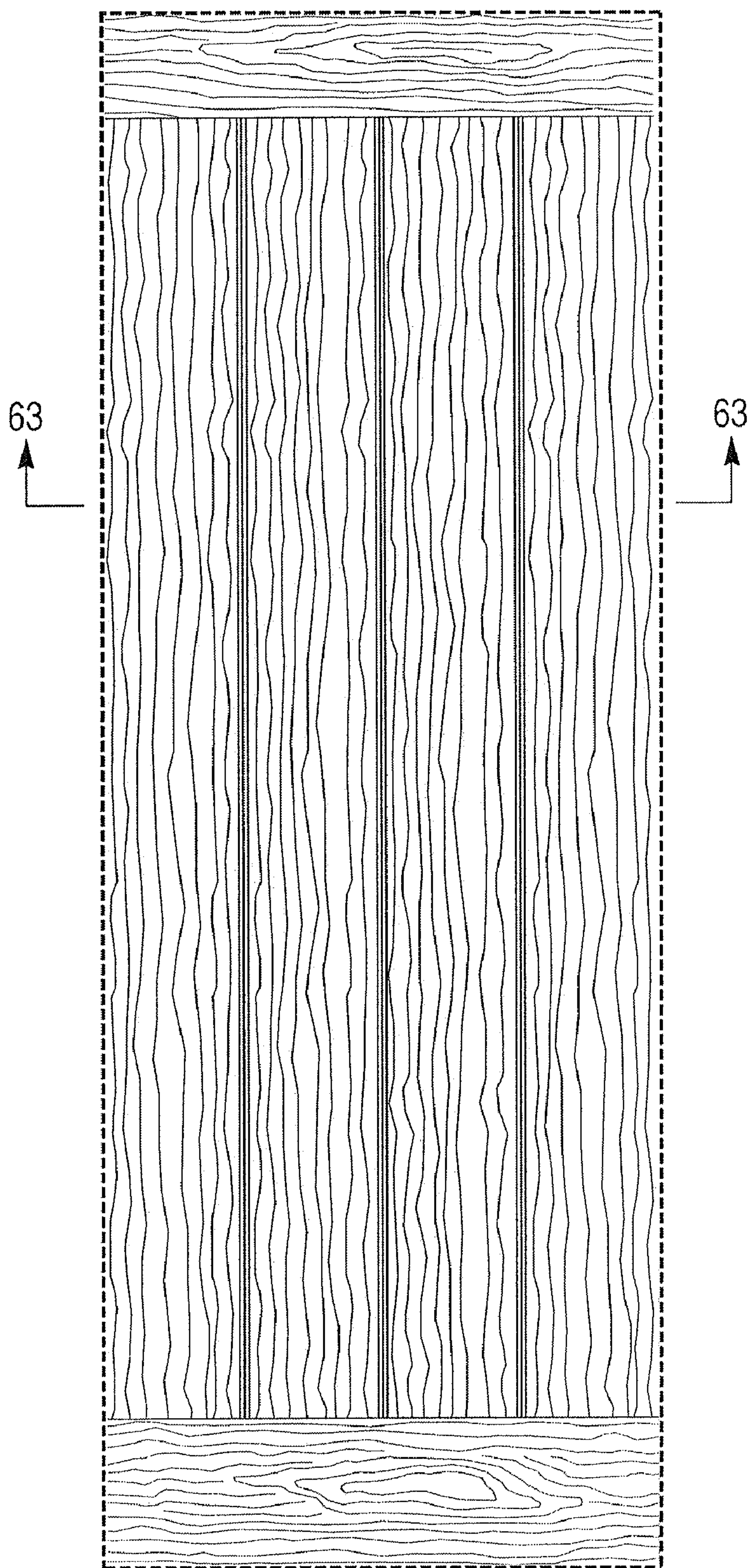

Fig. 58

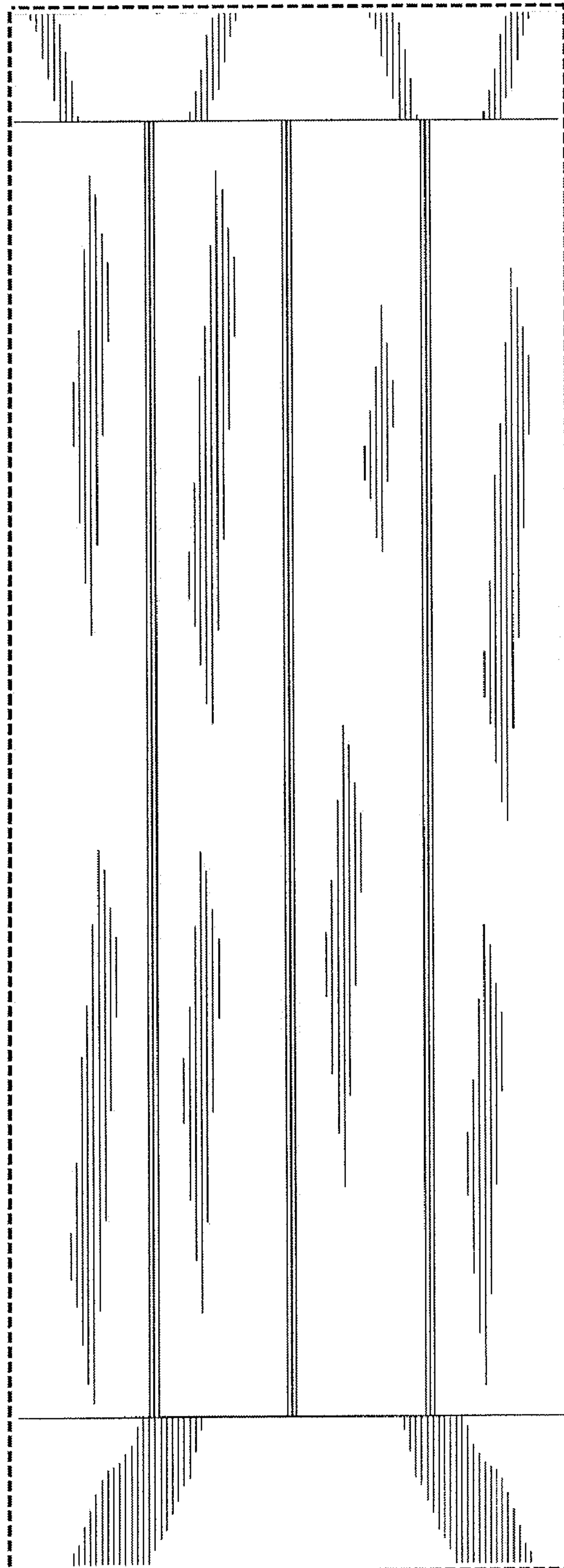

Fig. 59



Fig. 60



Fig. 61

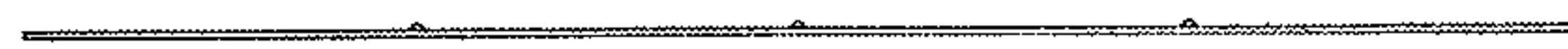

Fig. 62

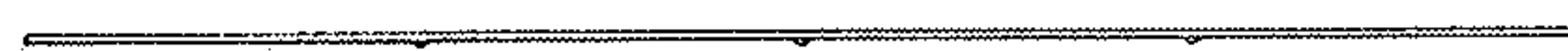

Fig. 63

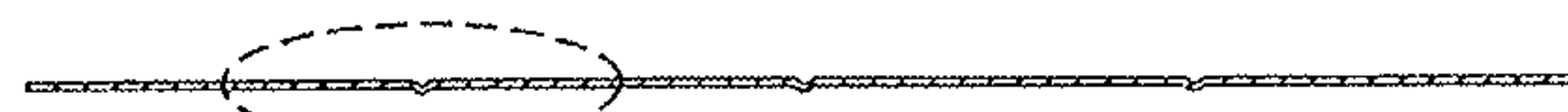

Fig. 64

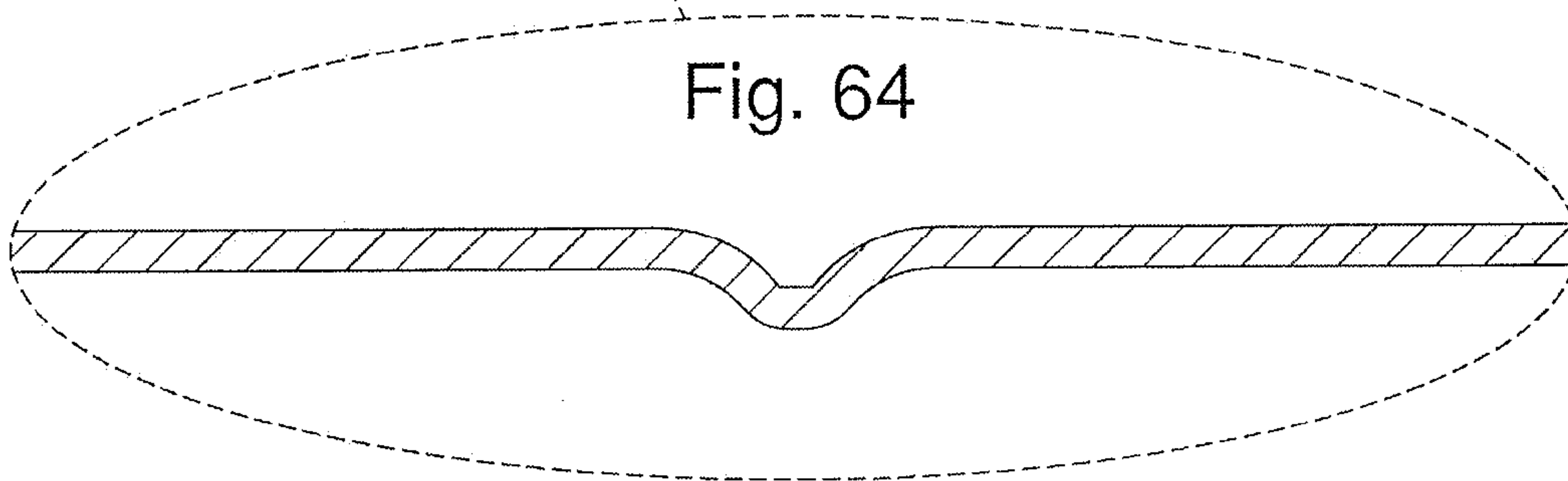

Fig. 65

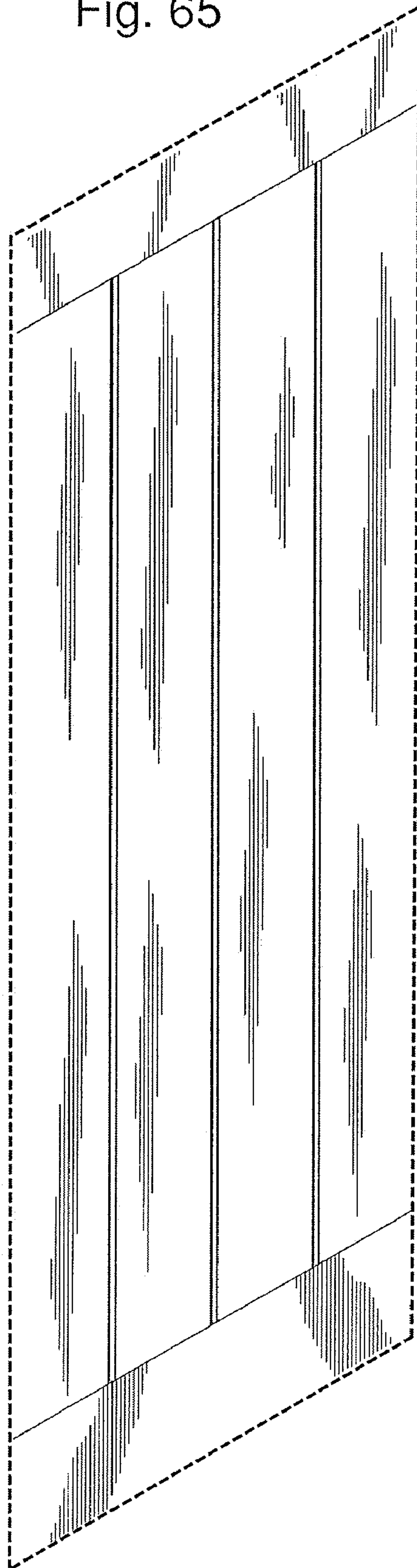

Fig. 66

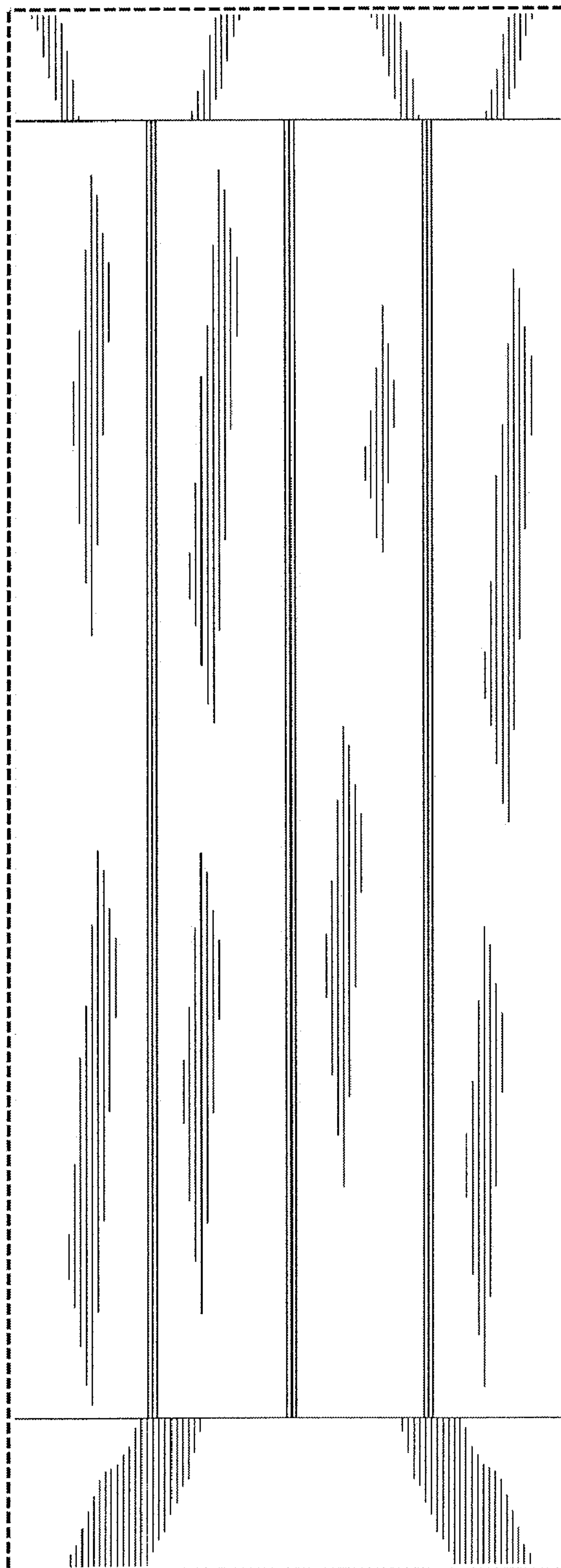

Fig. 67

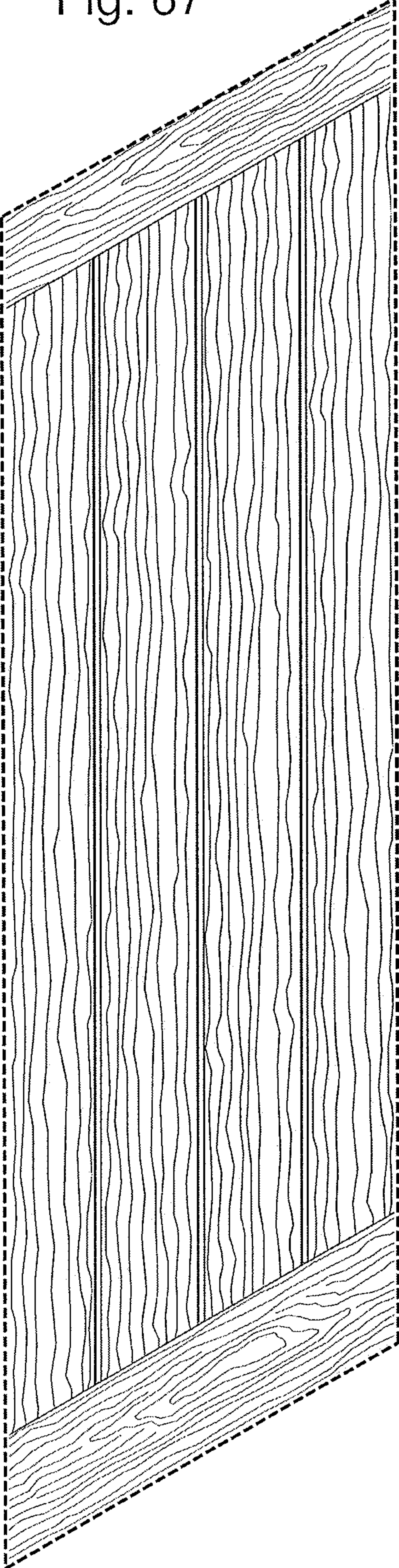

Fig. 68

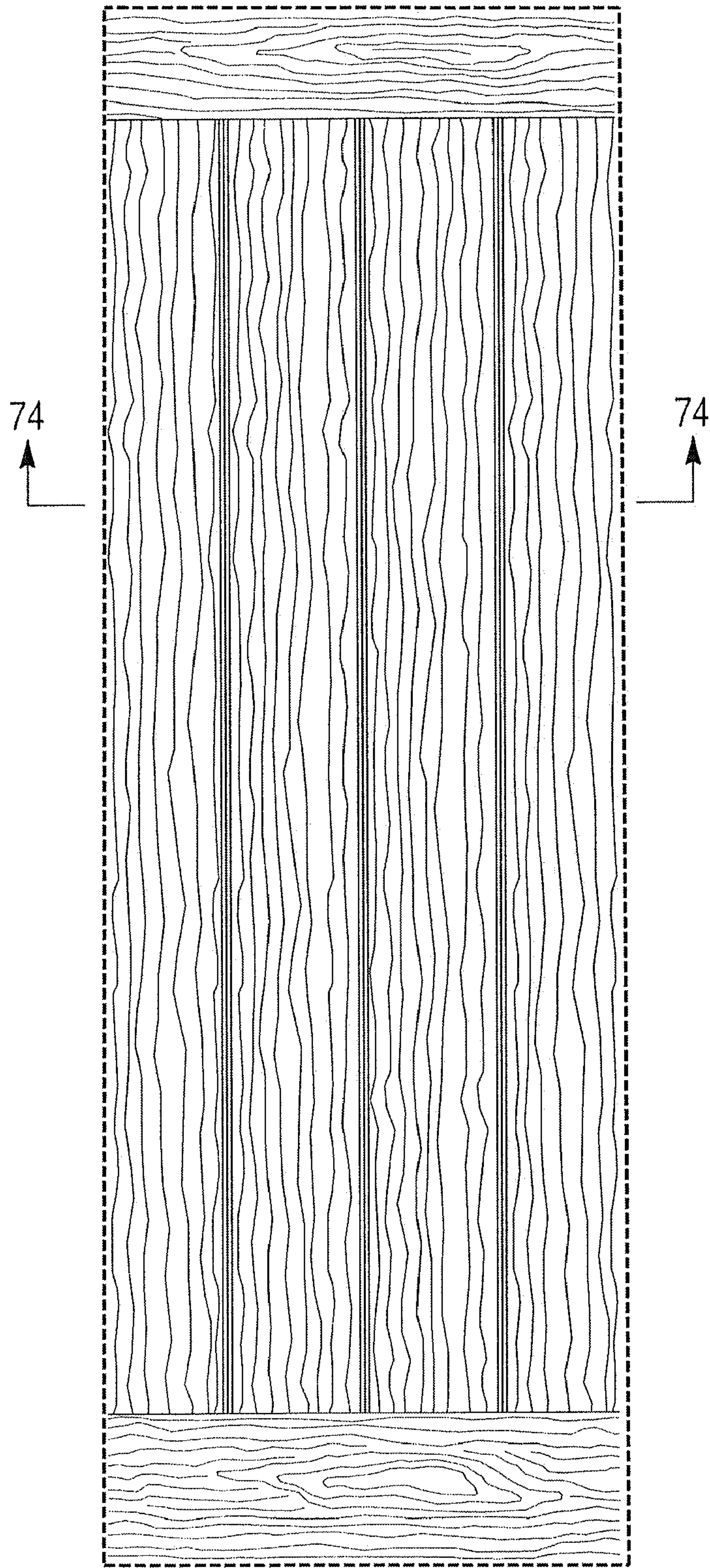

Fig. 69

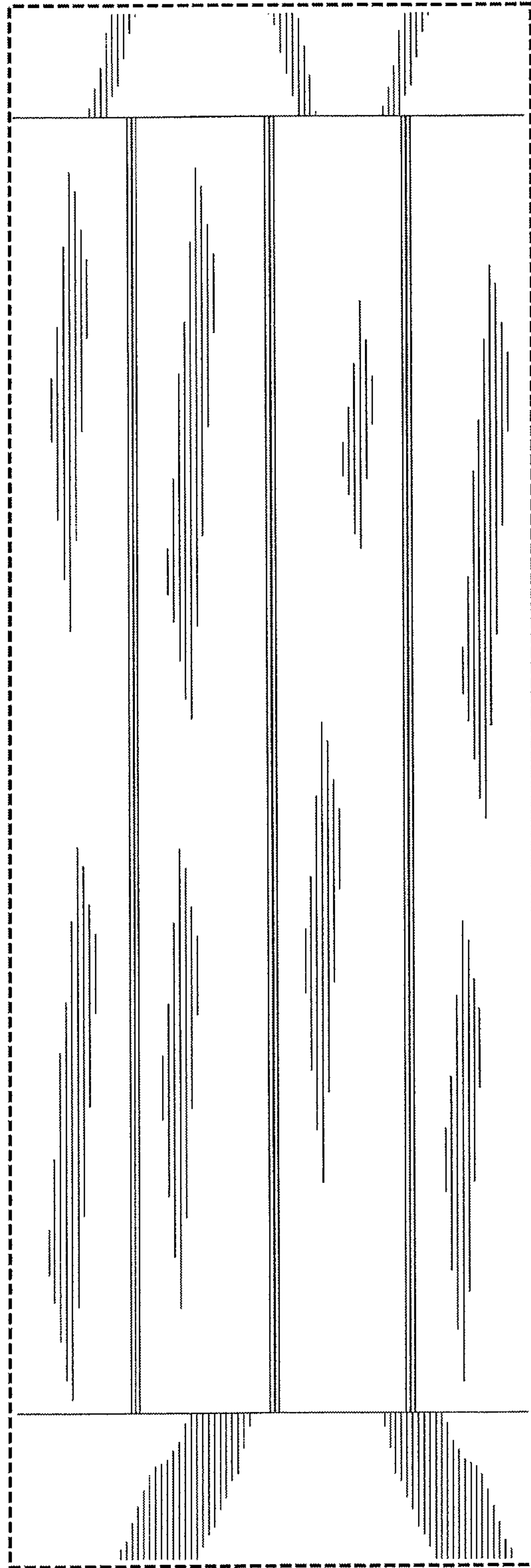

Fig. 70



Fig. 71

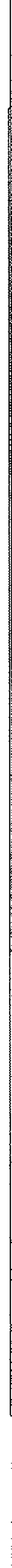

Fig. 72

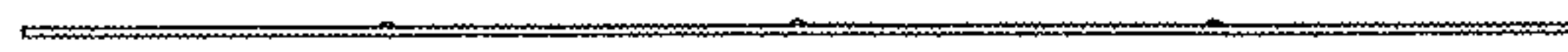

Fig. 73

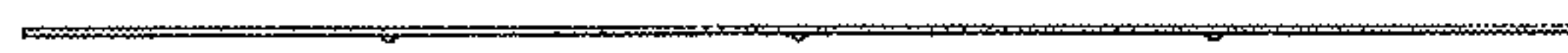

Fig. 74



Fig. 75

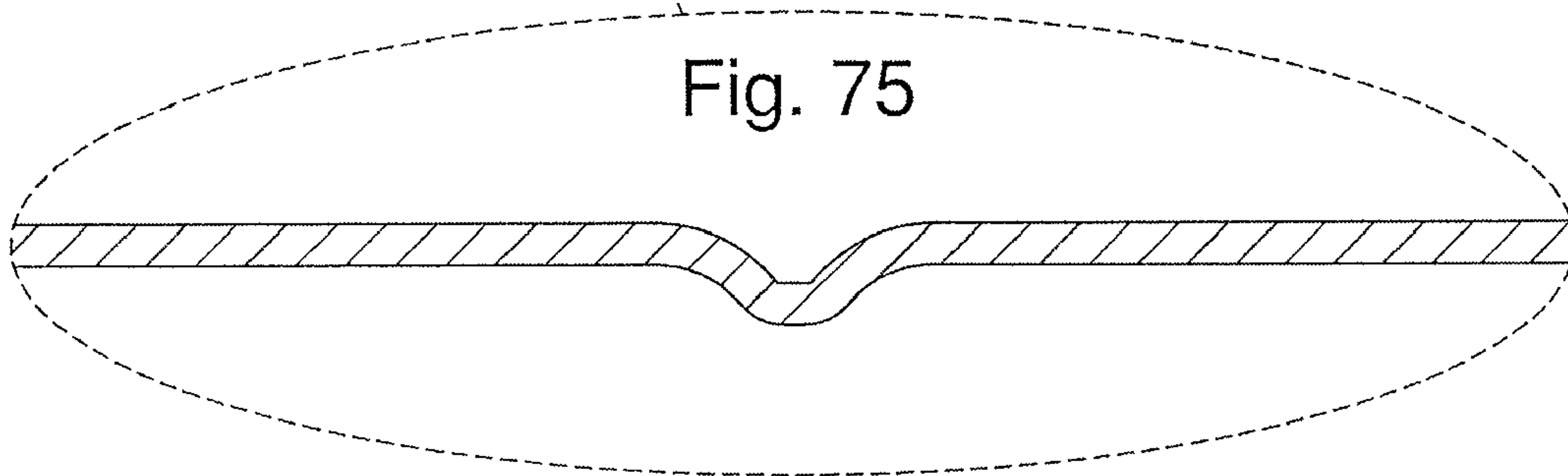

Fig. 76

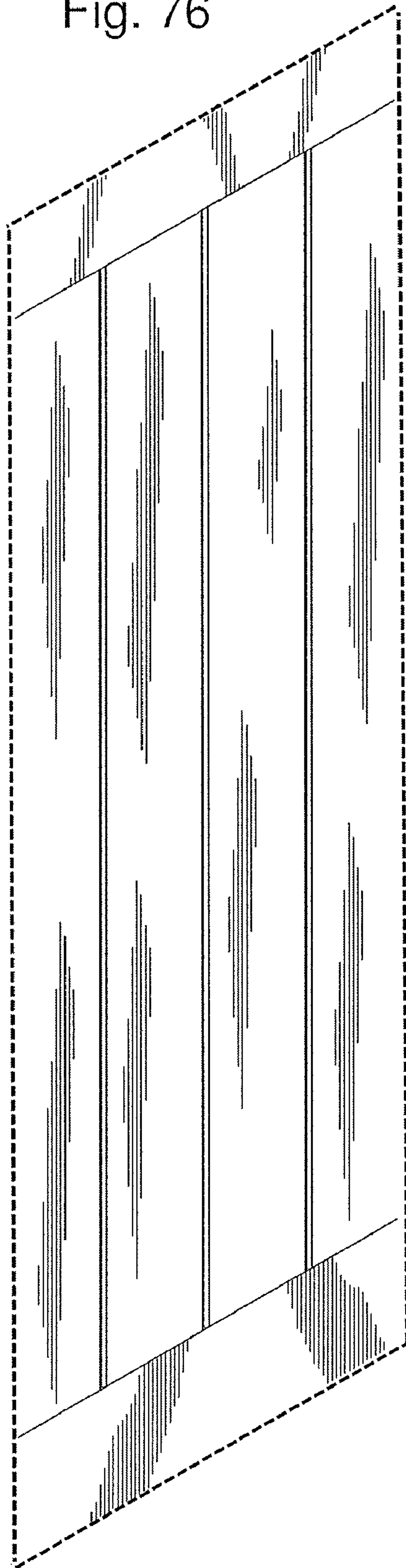

Fig. 77

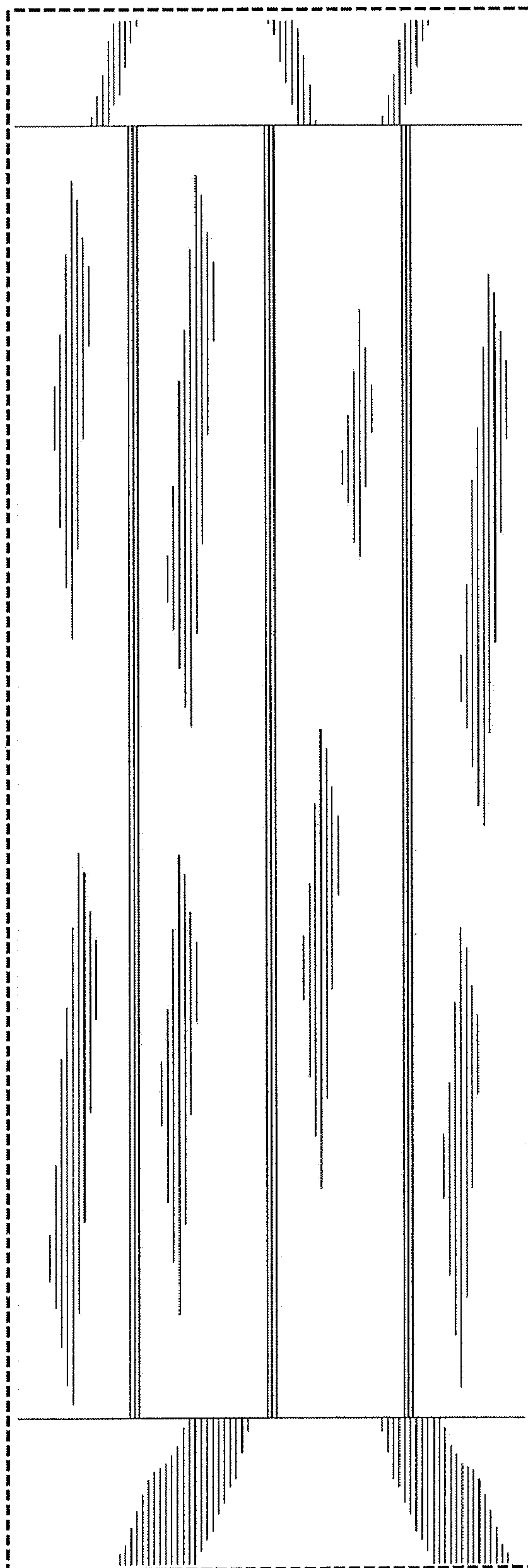

Fig. 78

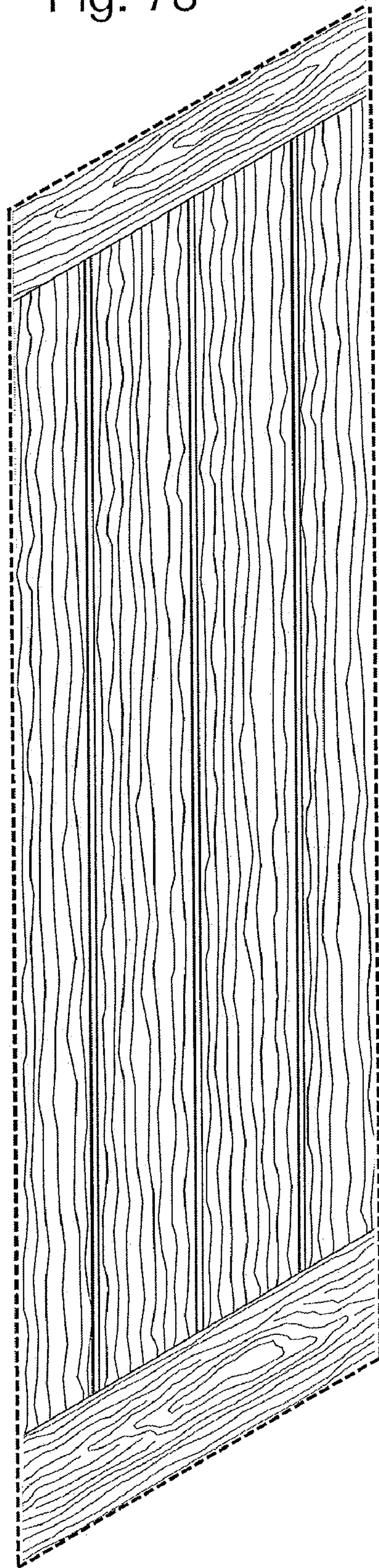

Fig. 79

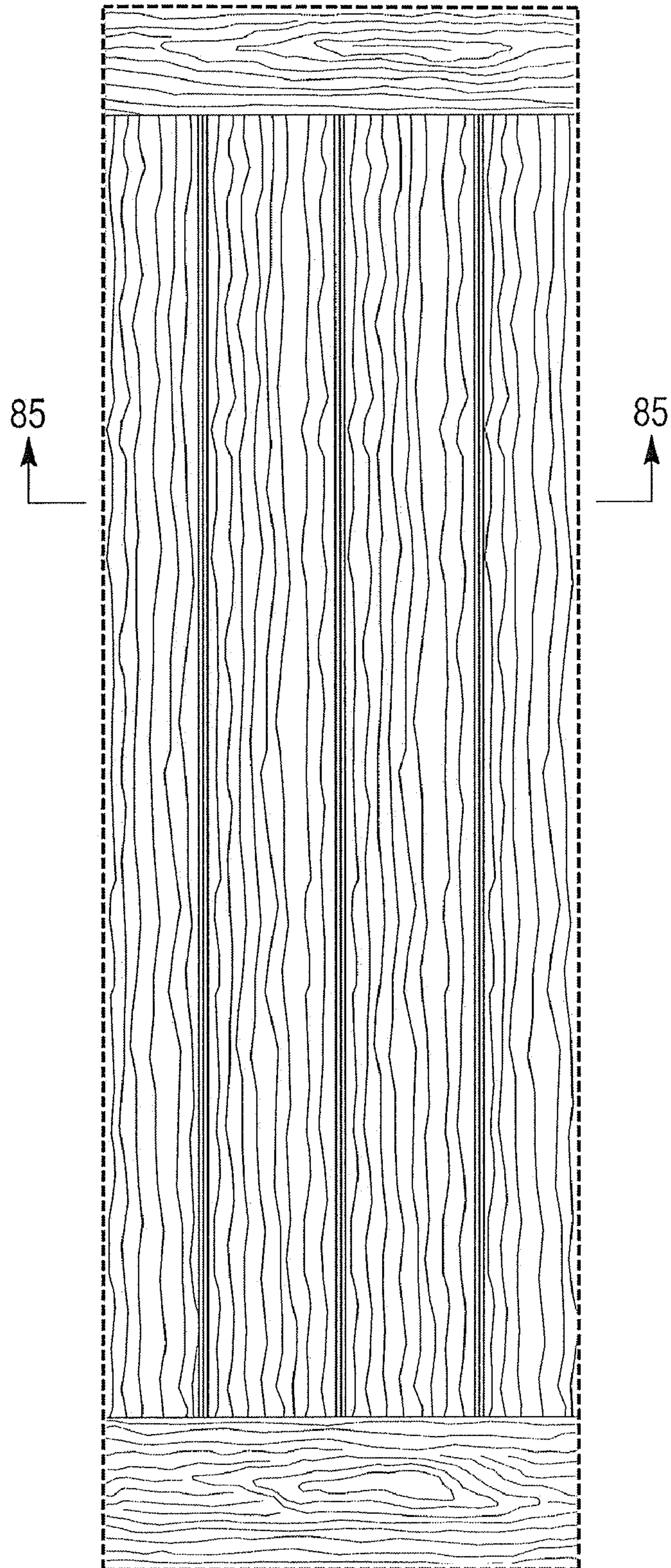

Fig. 80

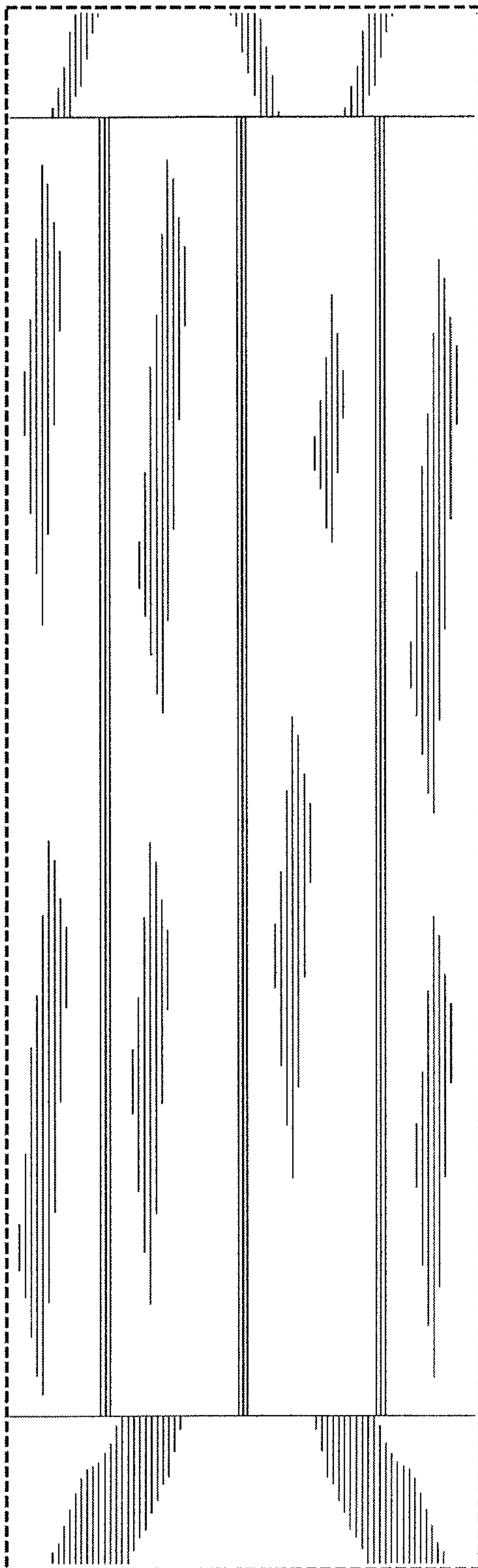

Fig. 81



Fig. 82

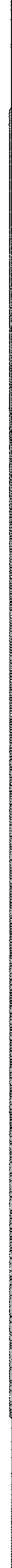

Fig. 83

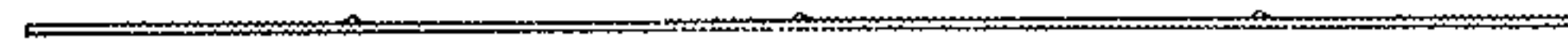

Fig. 84

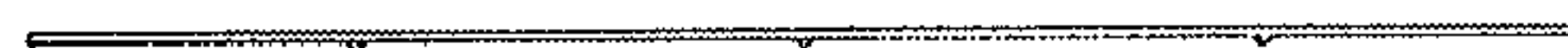

Fig. 85



Fig. 86

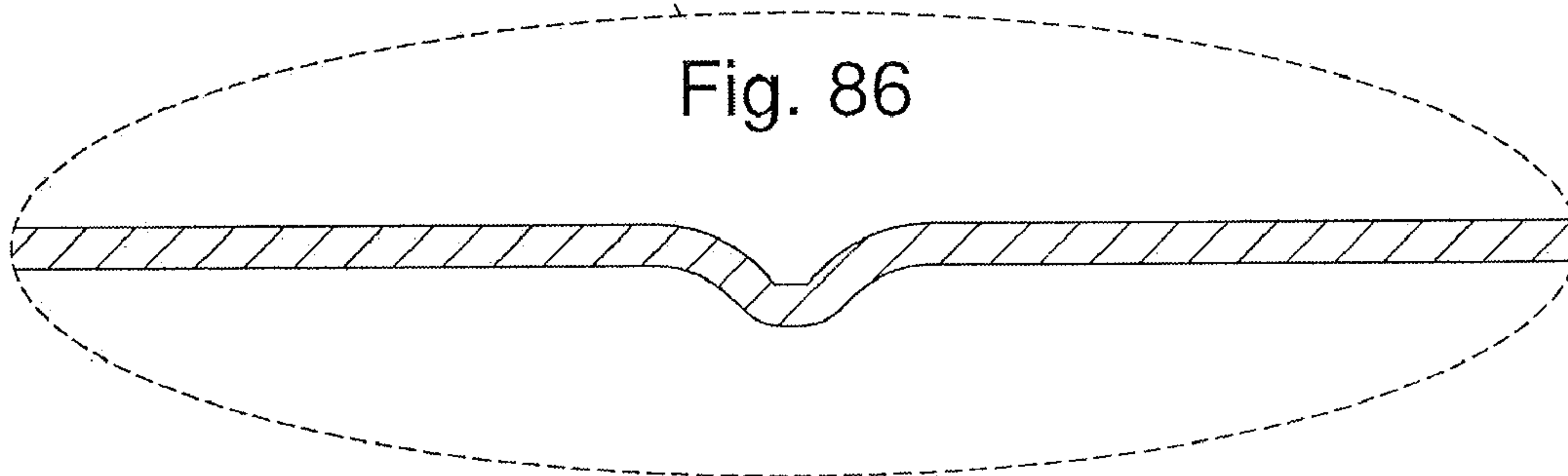

Fig. 87

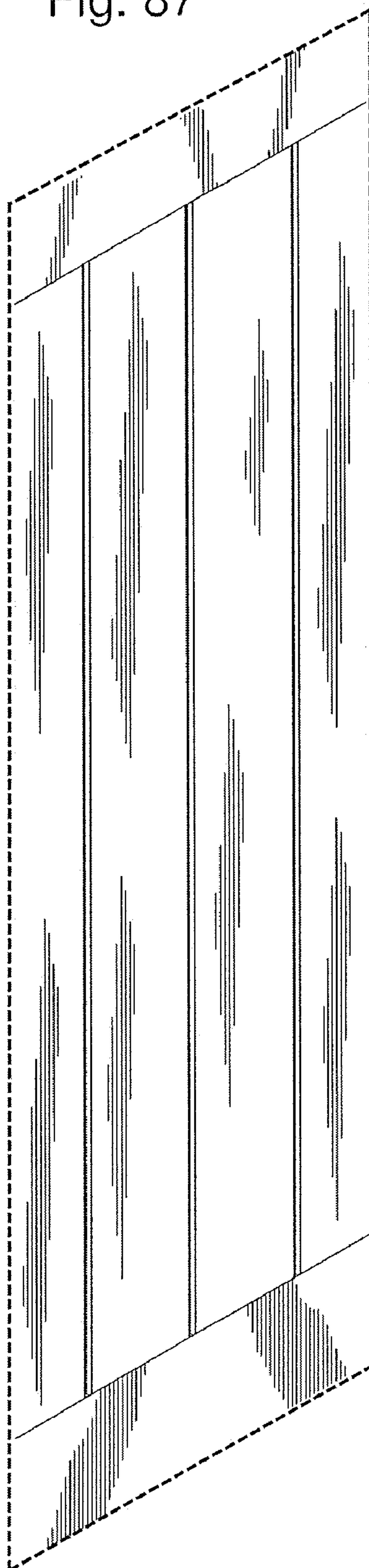

Fig. 88

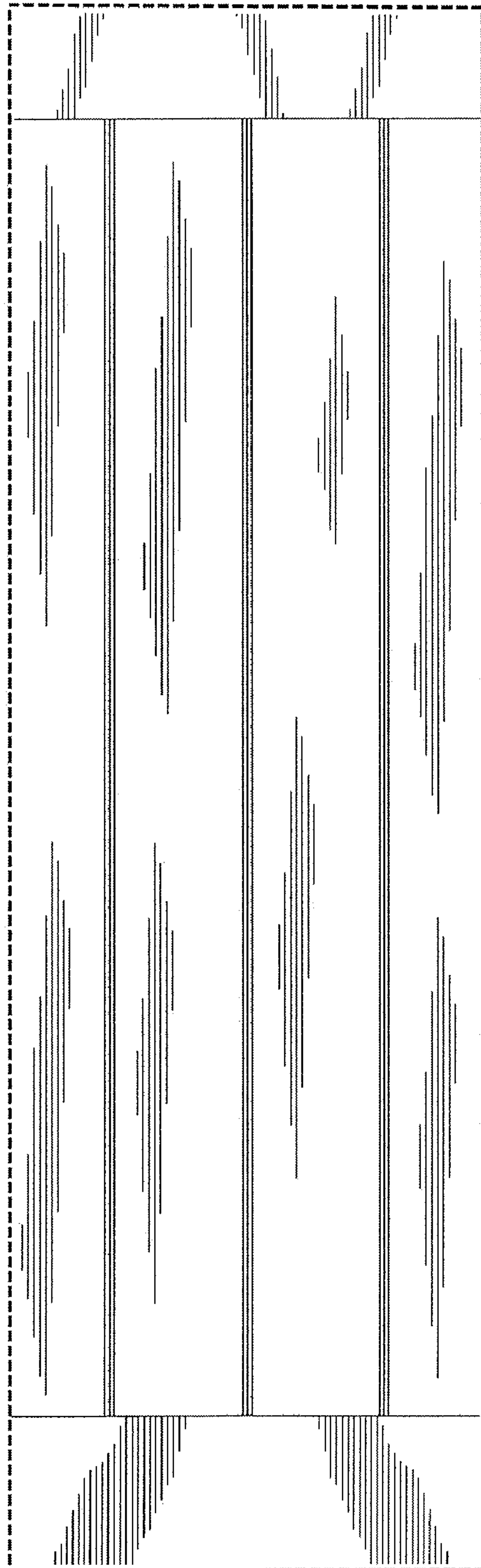

Fig. 89

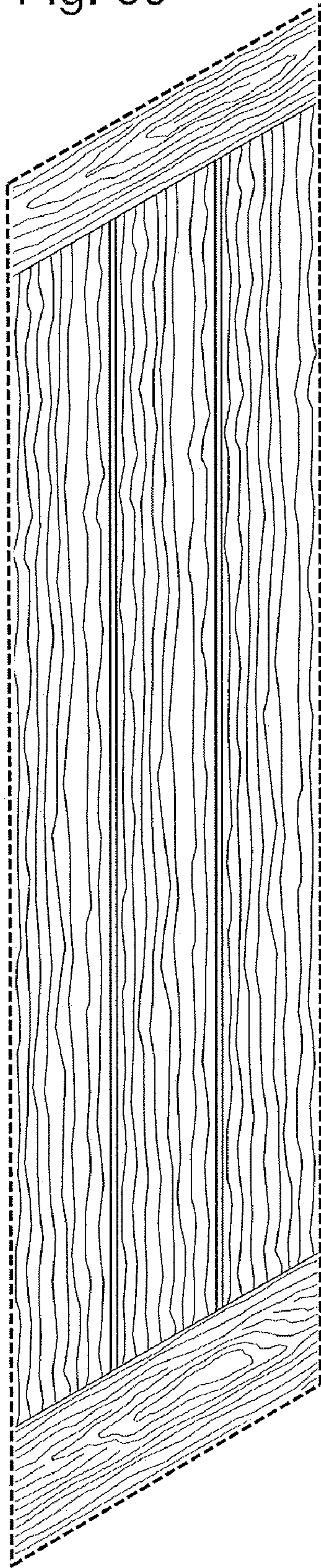

Fig. 90

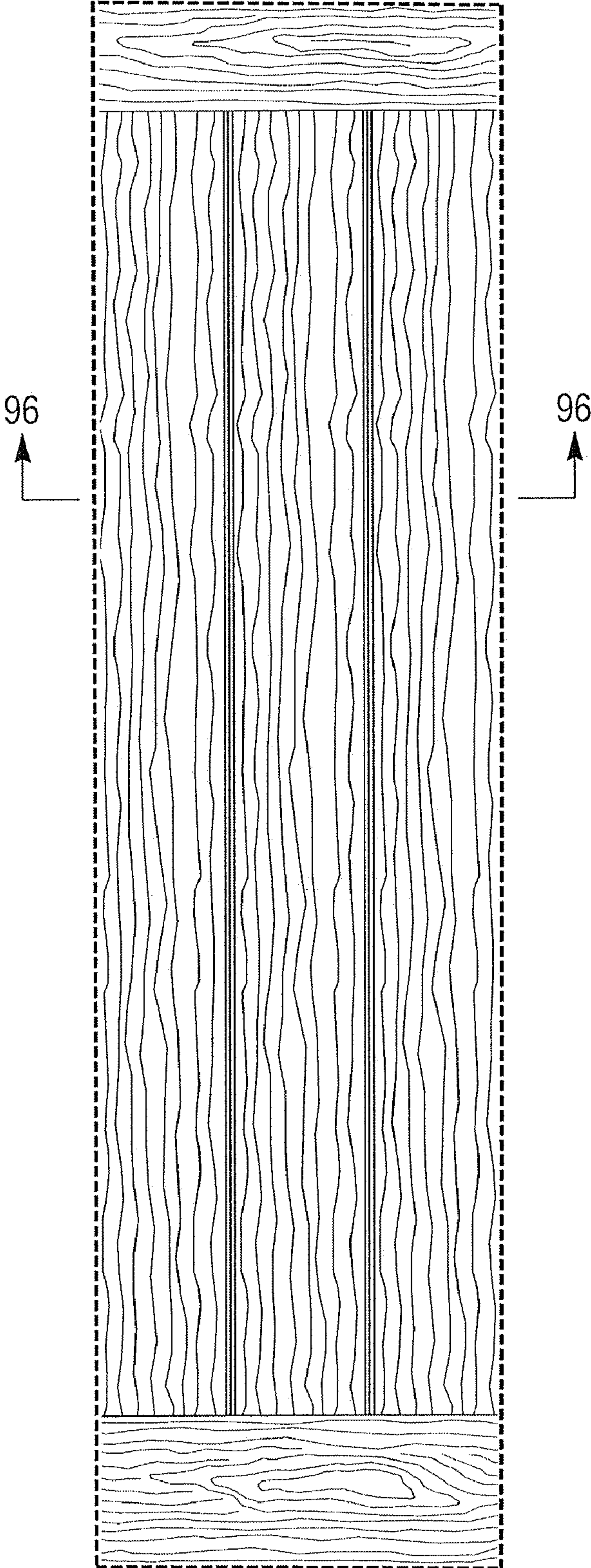

Fig. 91

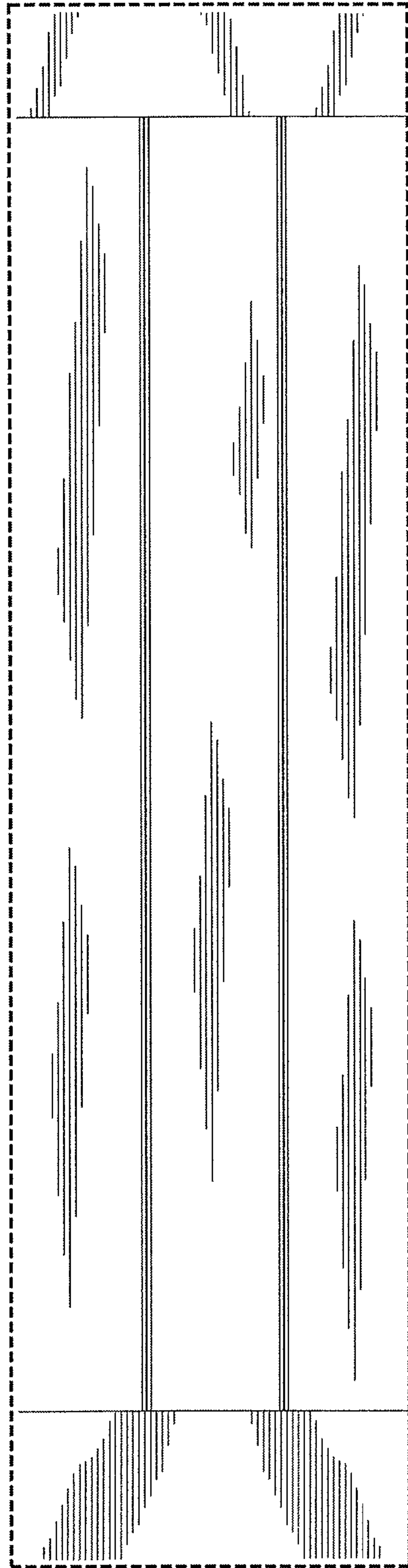

Fig. 92



Fig. 93



Fig. 94

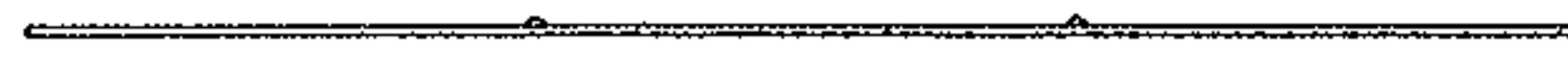

Fig. 95

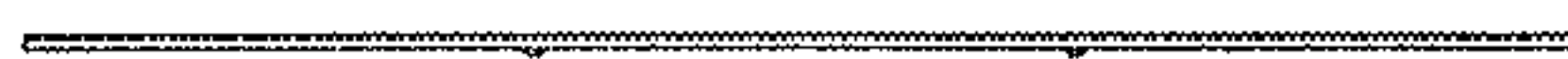

Fig. 96

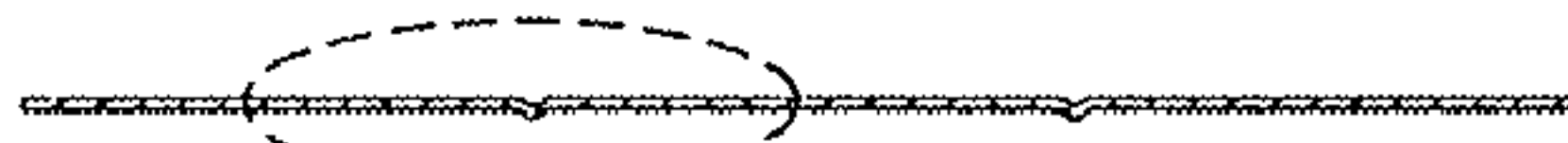

Fig. 97

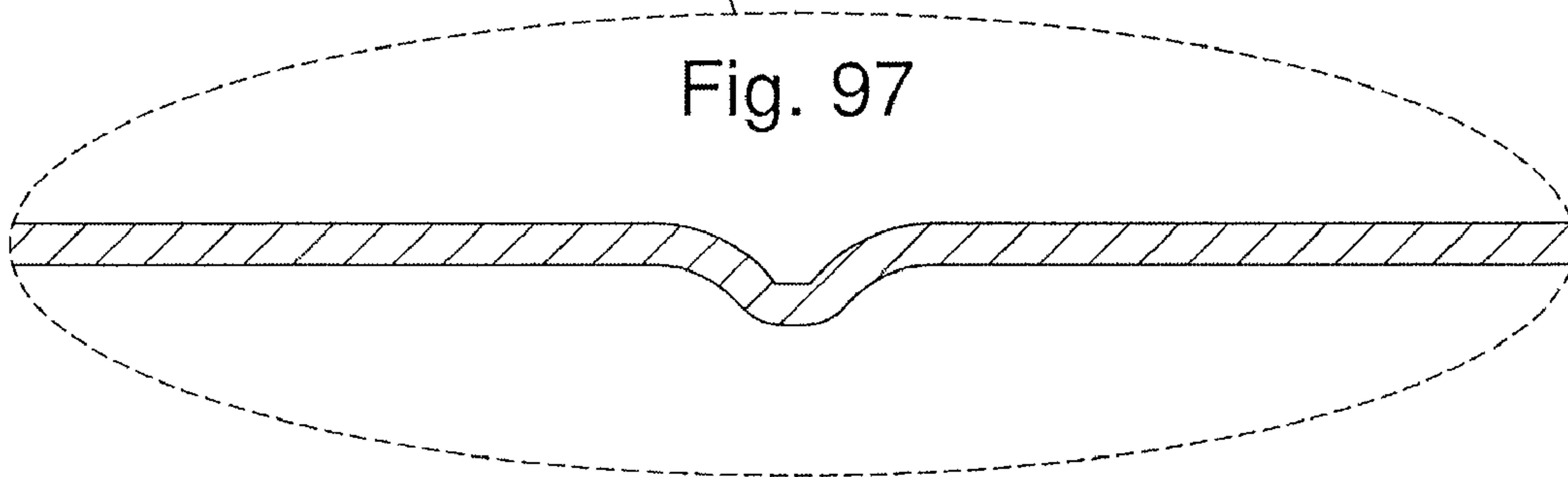

Fig. 98

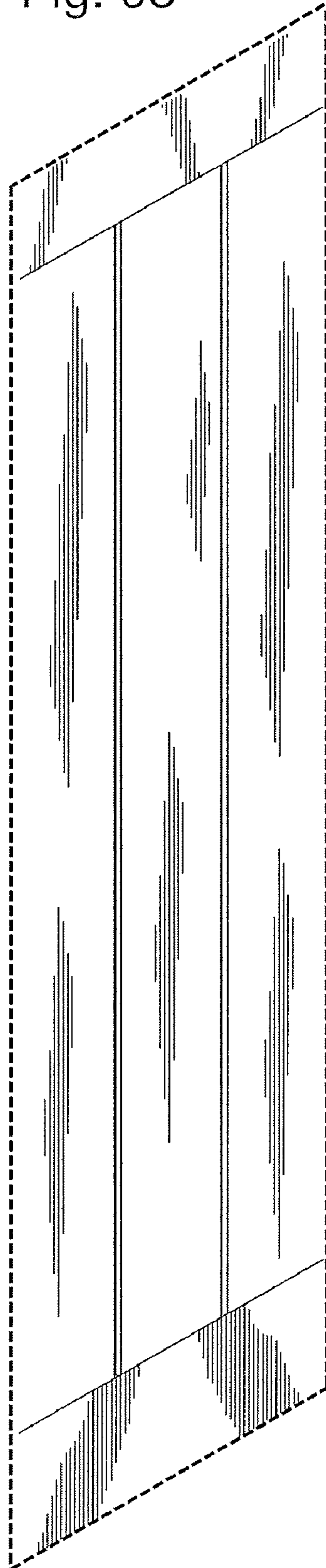

Fig. 99

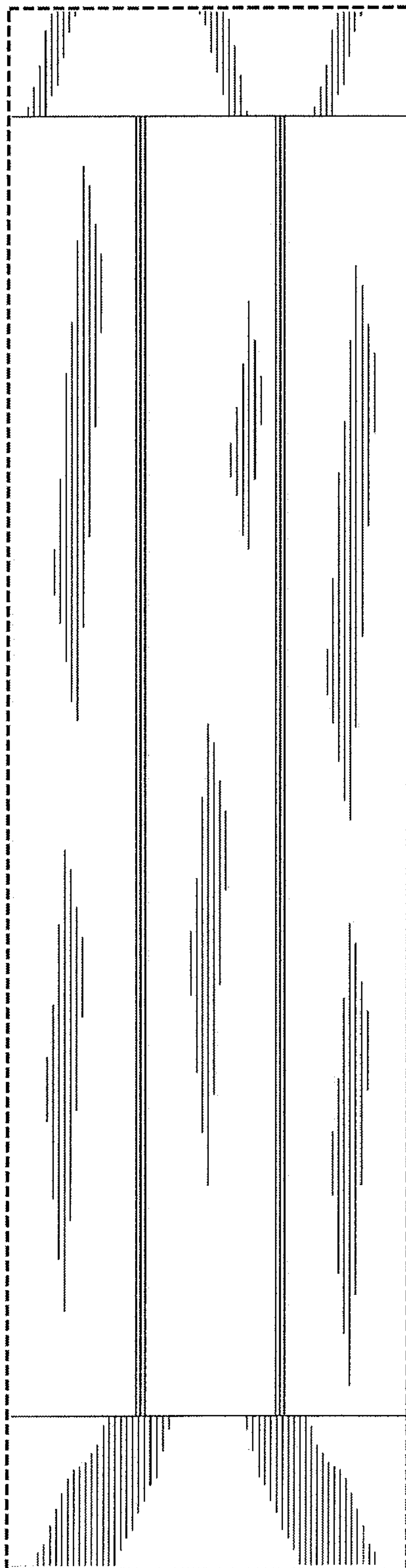

Fig. 100

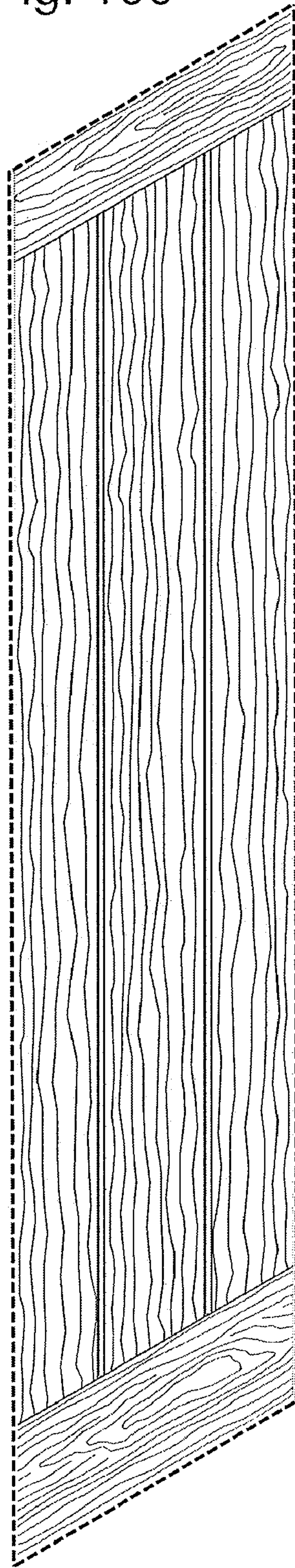

Fig. 101

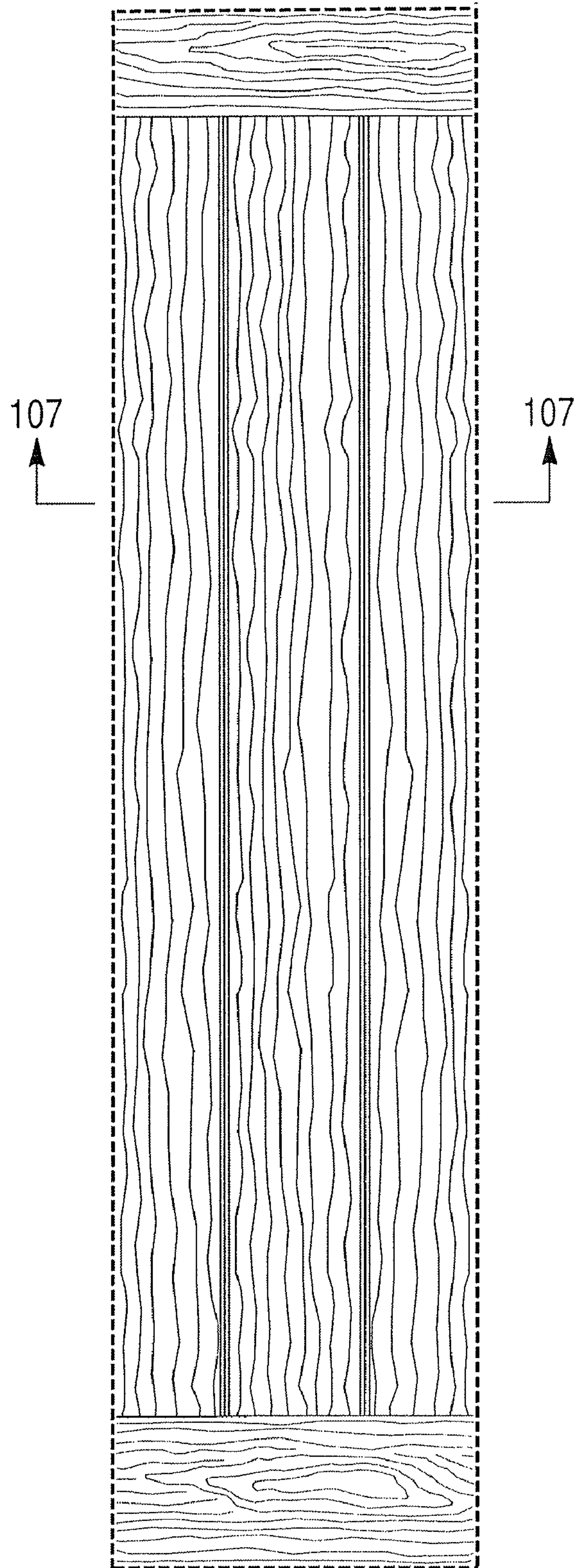

Fig. 102

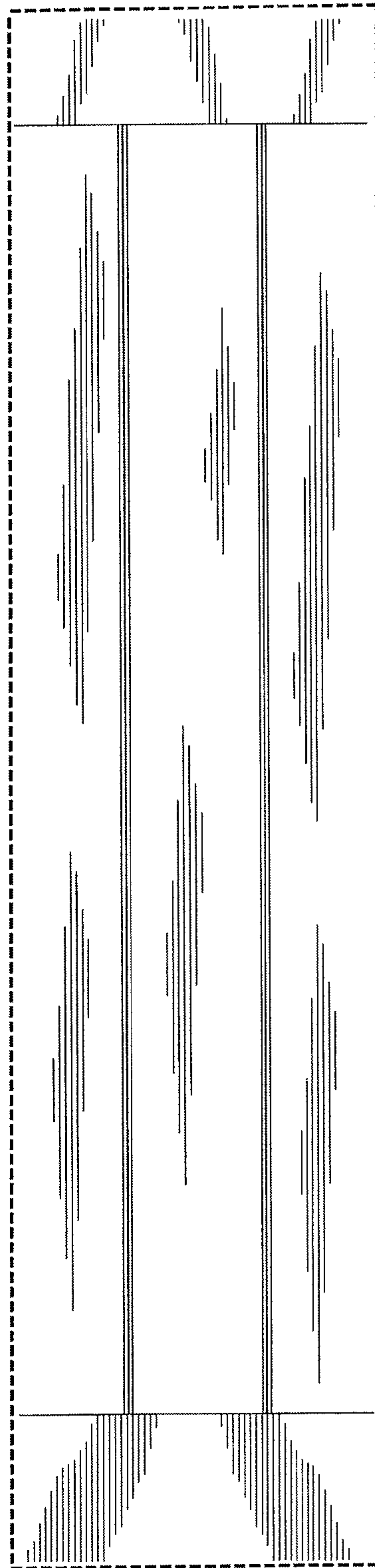

Fig. 103



Fig. 104



Fig. 105

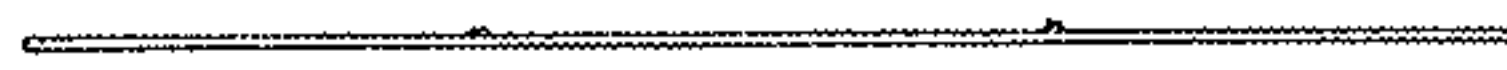

Fig. 106

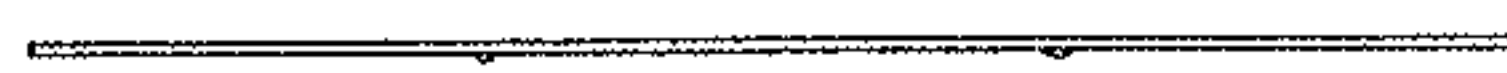

Fig. 107

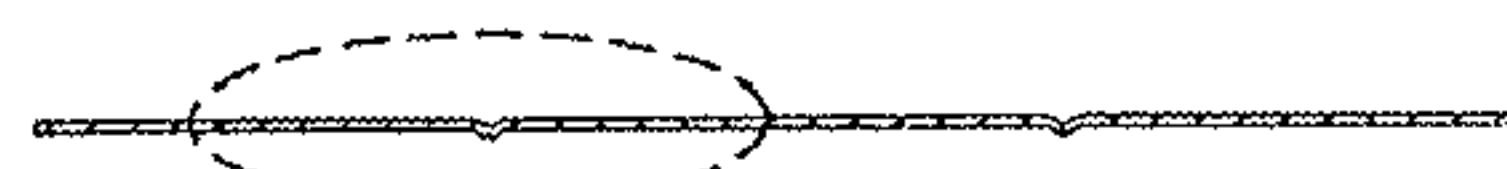

Fig. 108

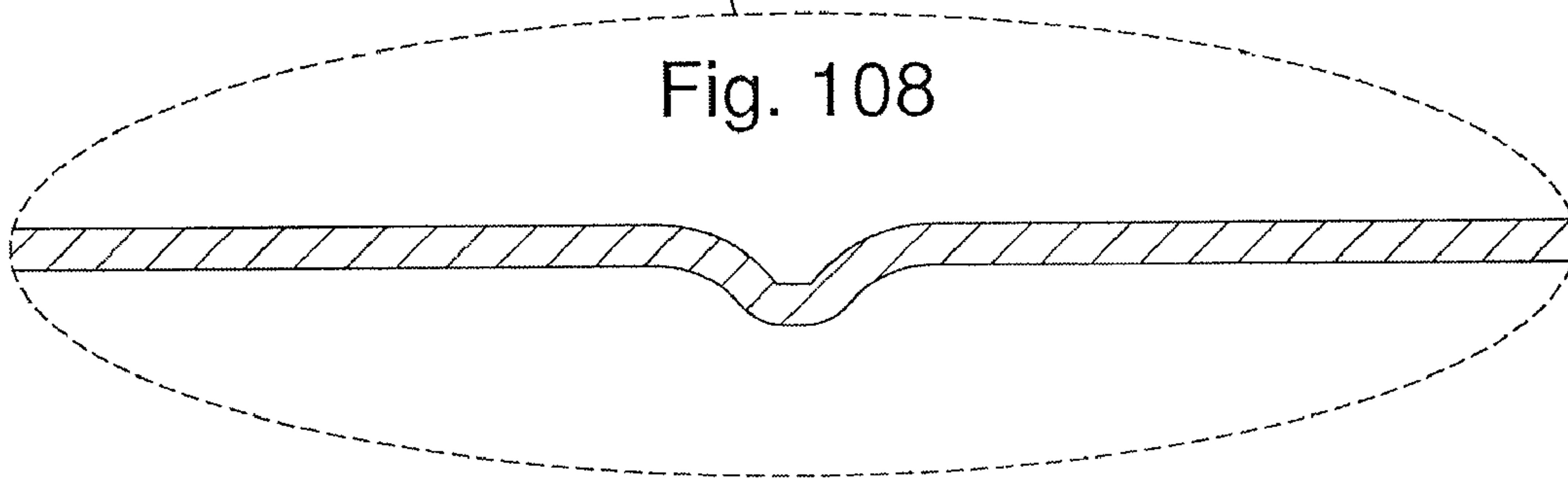

Fig. 109

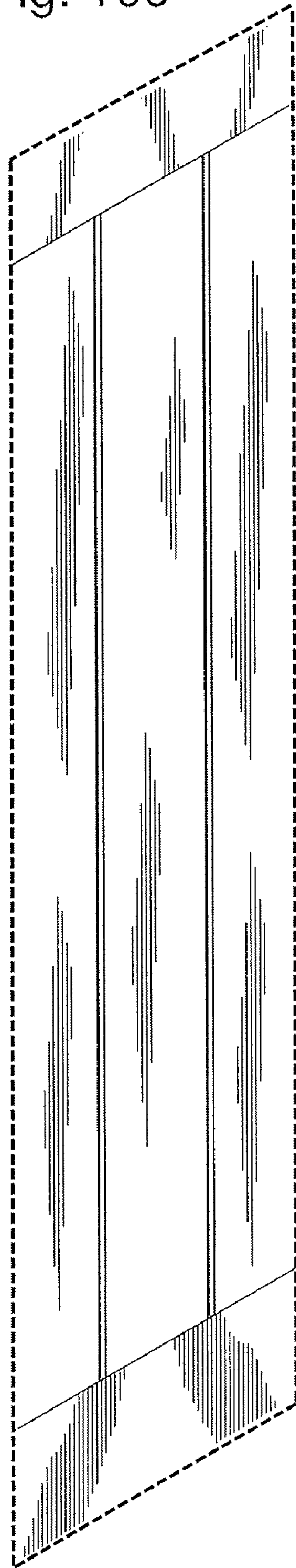

Fig. 110

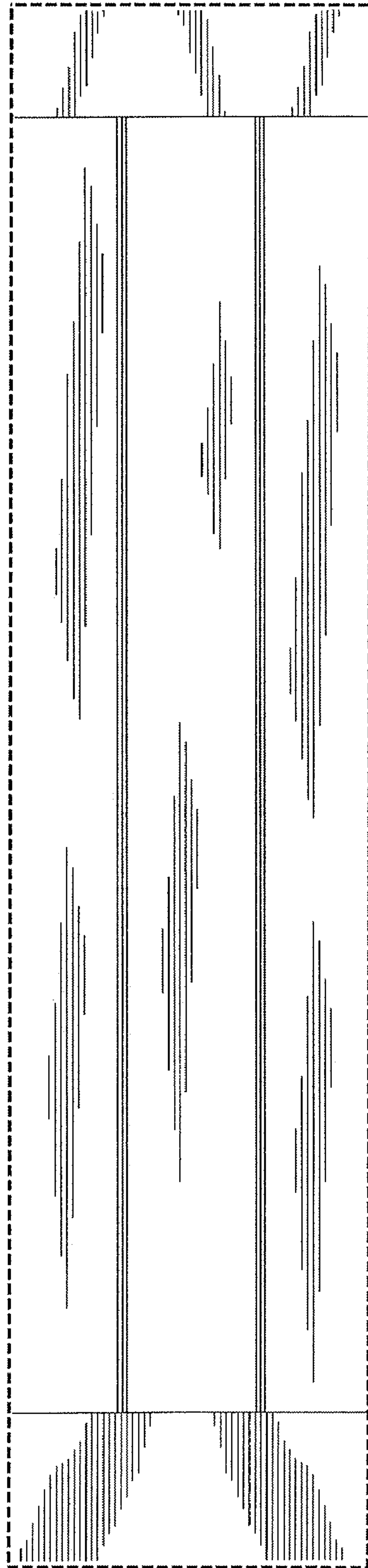

Fig. 111

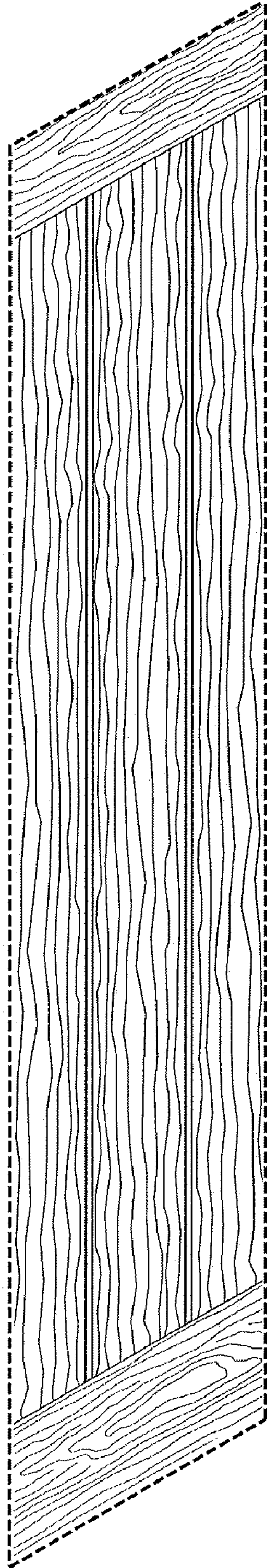

Fig. 112

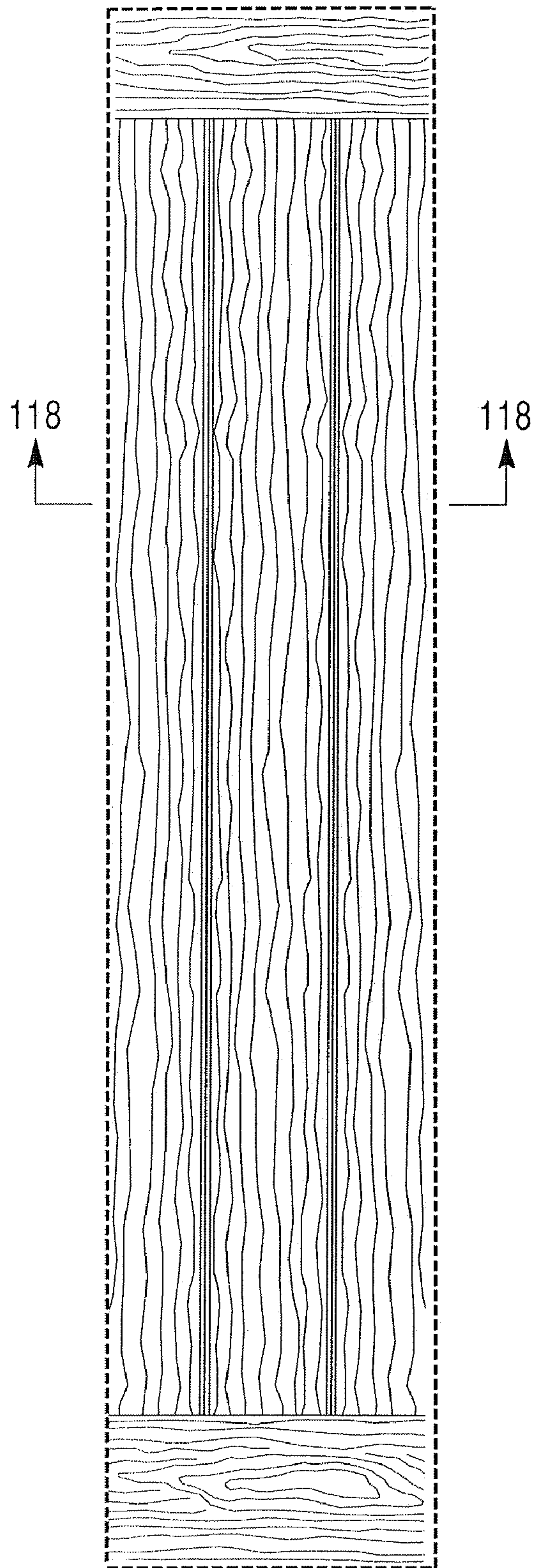

Fig. 113

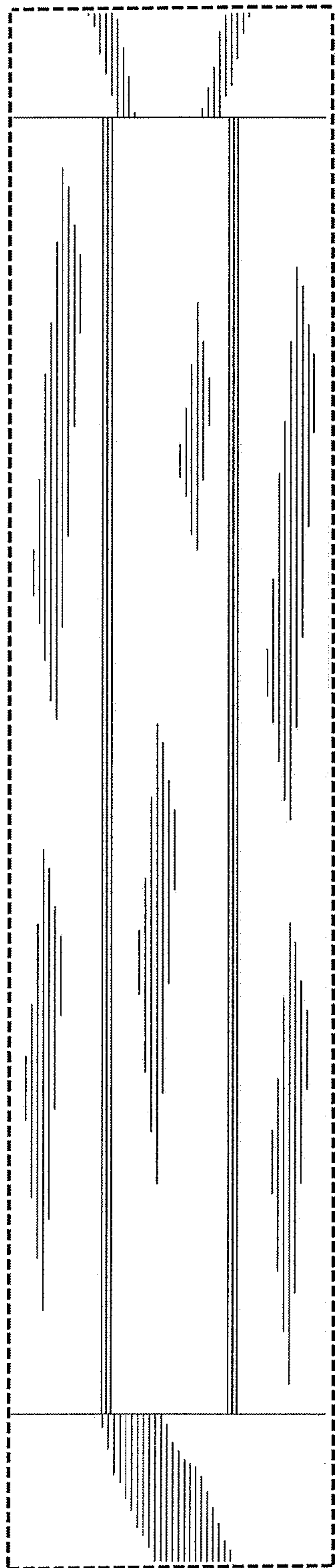

Fig. 114



Fig. 115



Fig. 116



Fig. 117

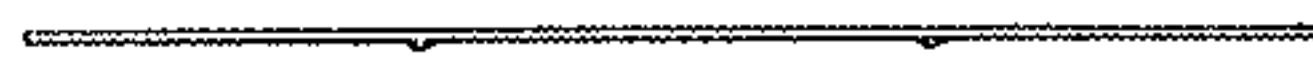

Fig. 118



Fig. 119

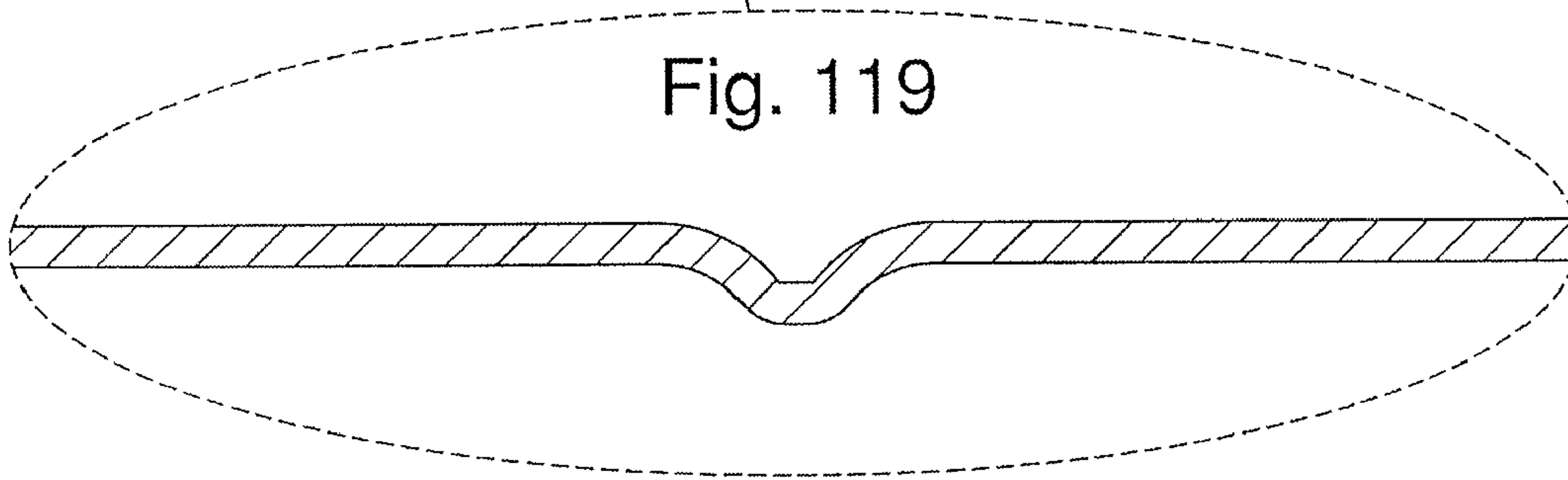

Fig. 120

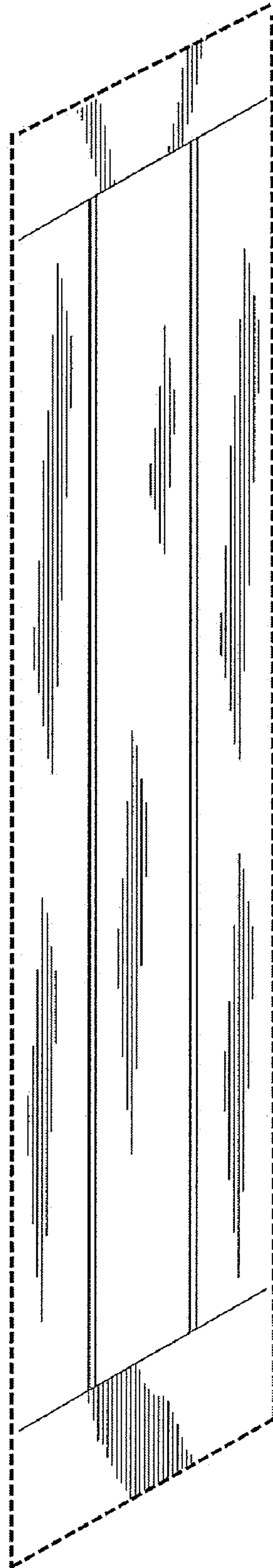

Fig. 121

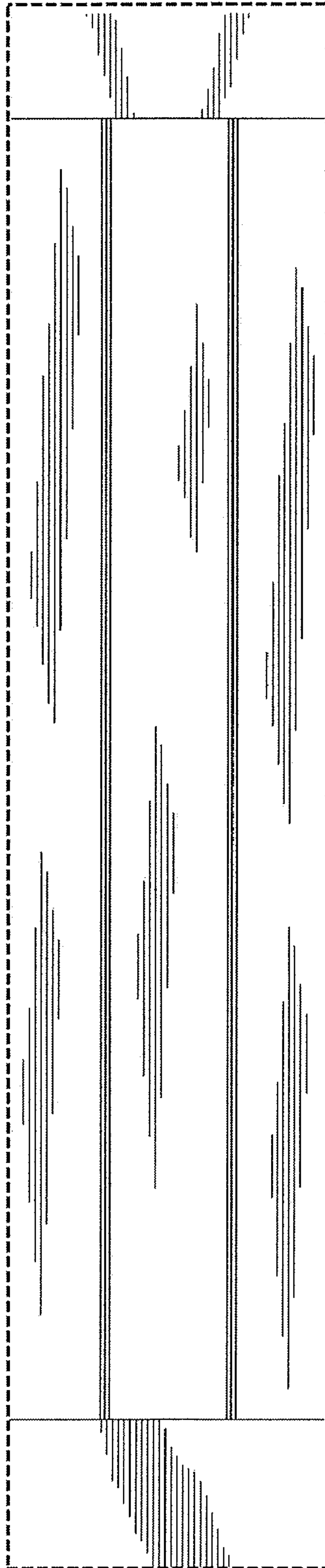

Fig. 122

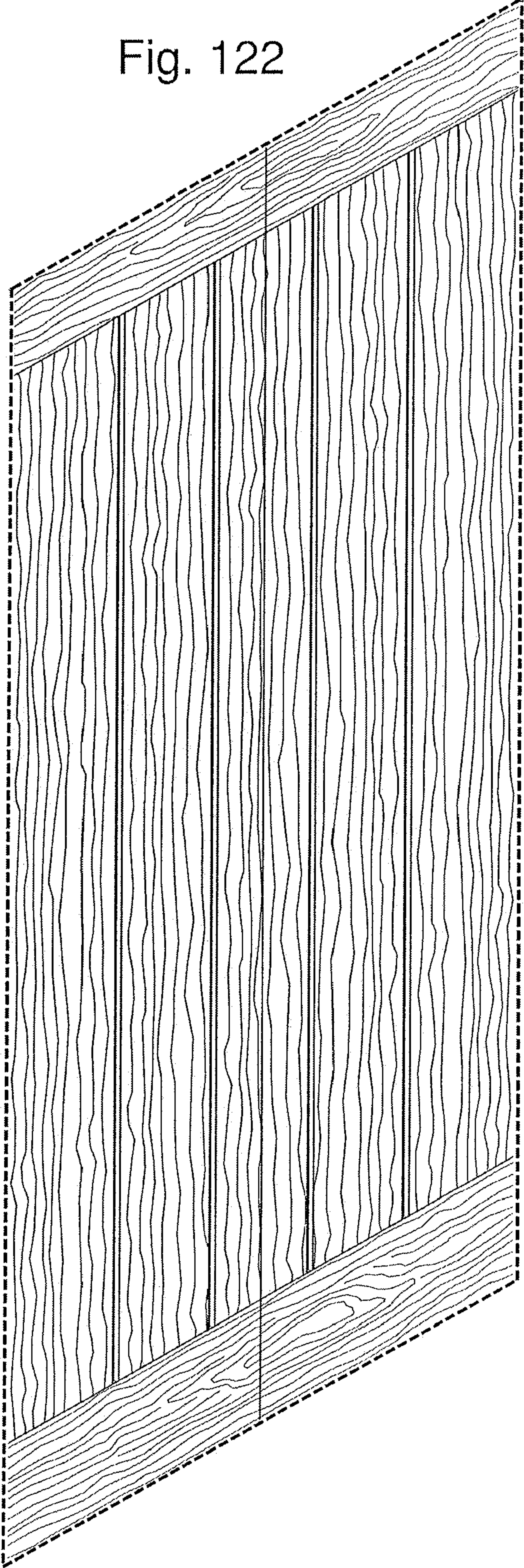

Fig. 123

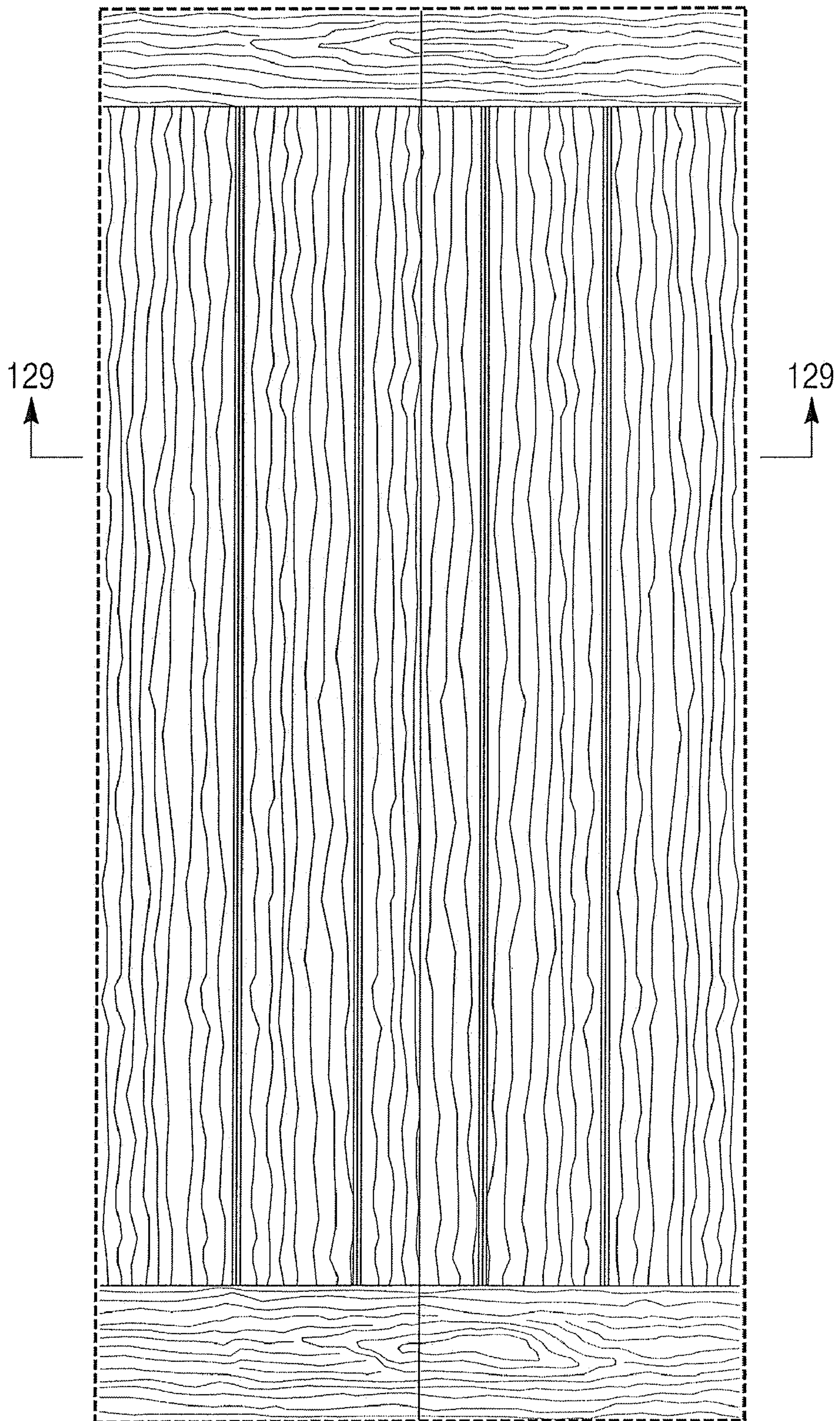

Fig. 124

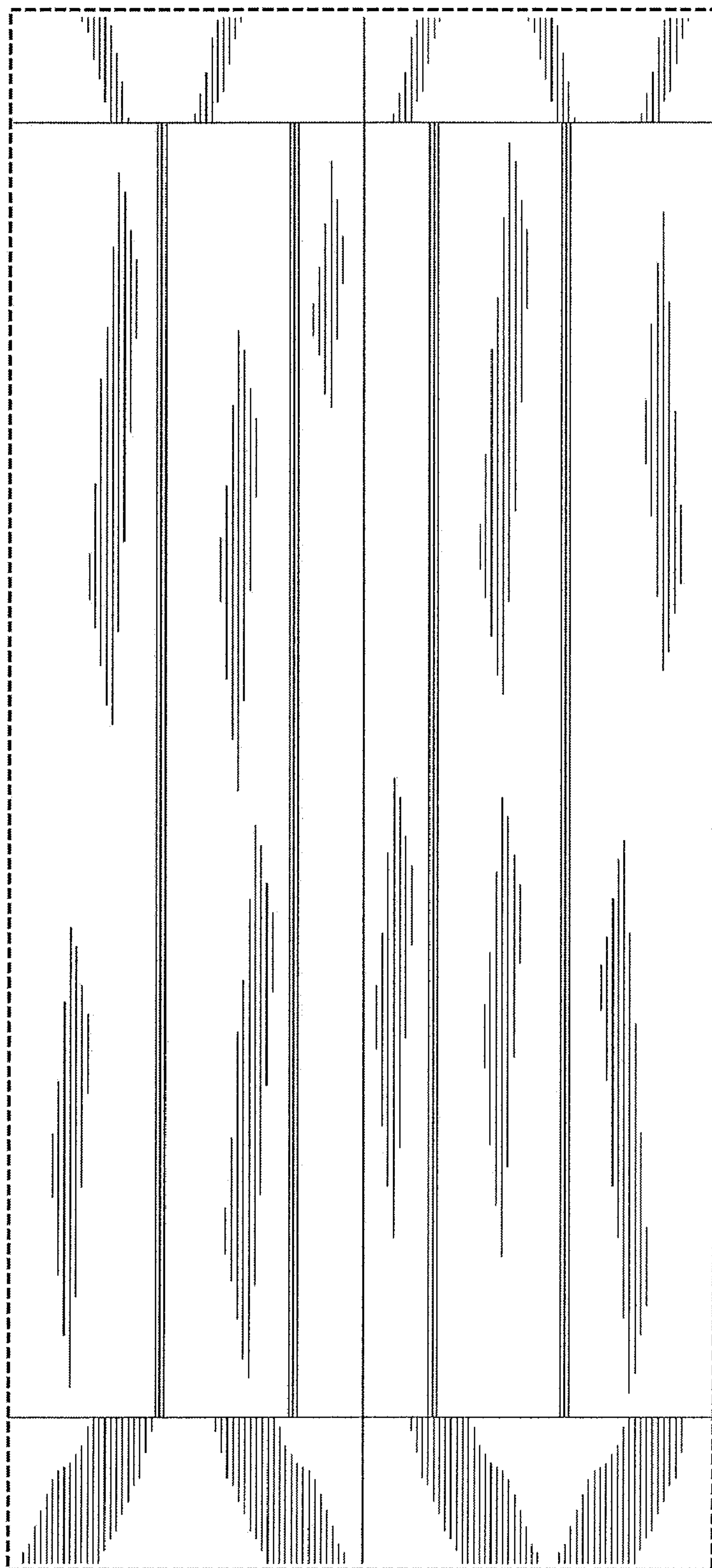

Fig. 125



Fig. 126



Fig. 127

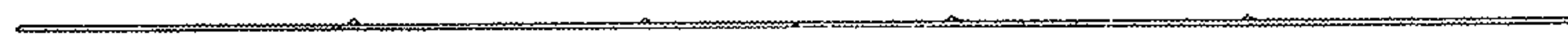

Fig. 128

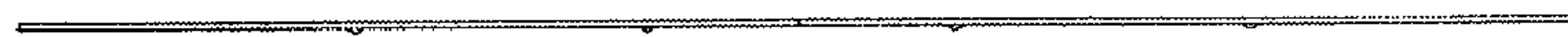

Fig. 129



Fig. 130

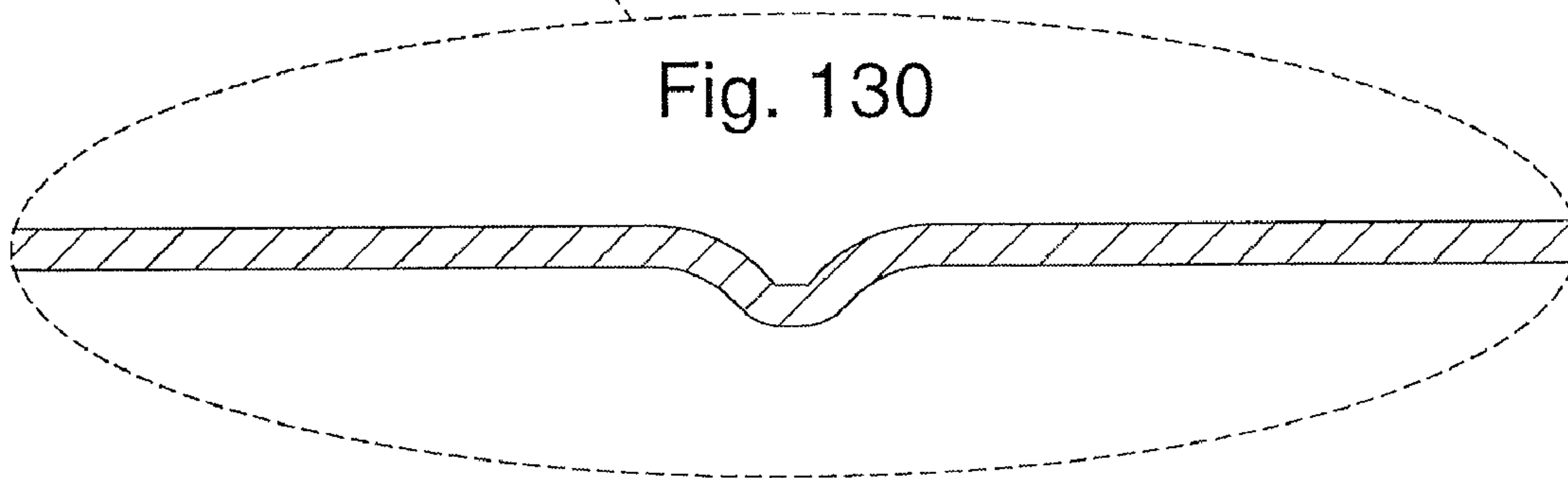

Fig. 131

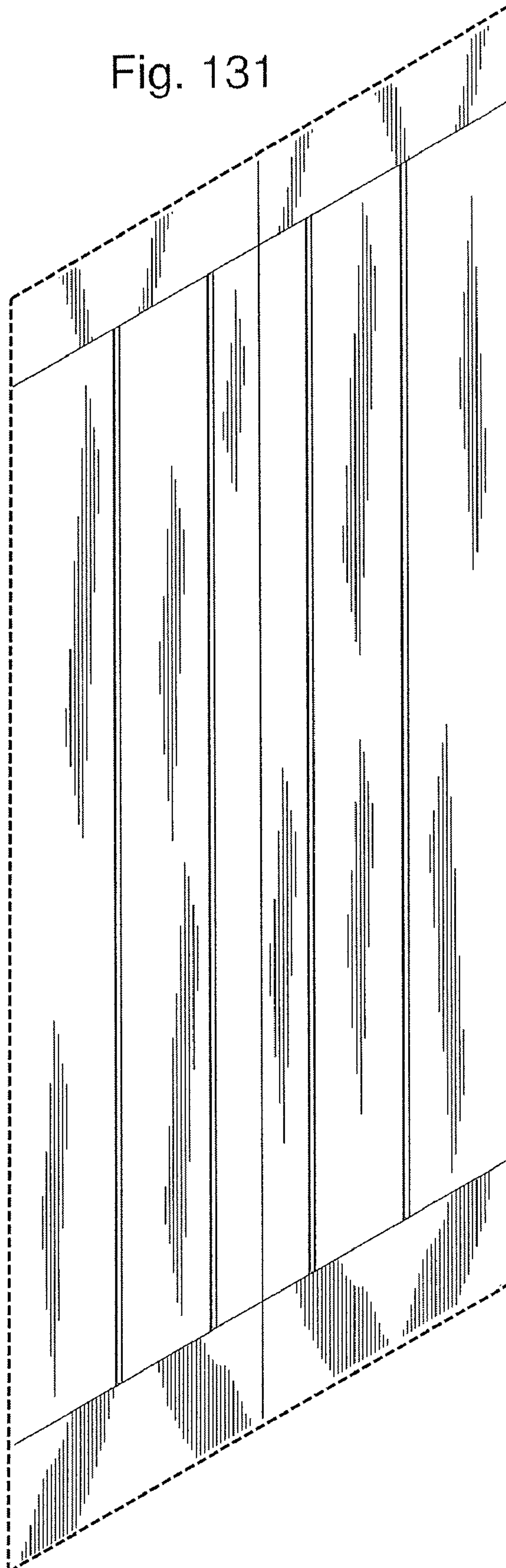

Fig. 132

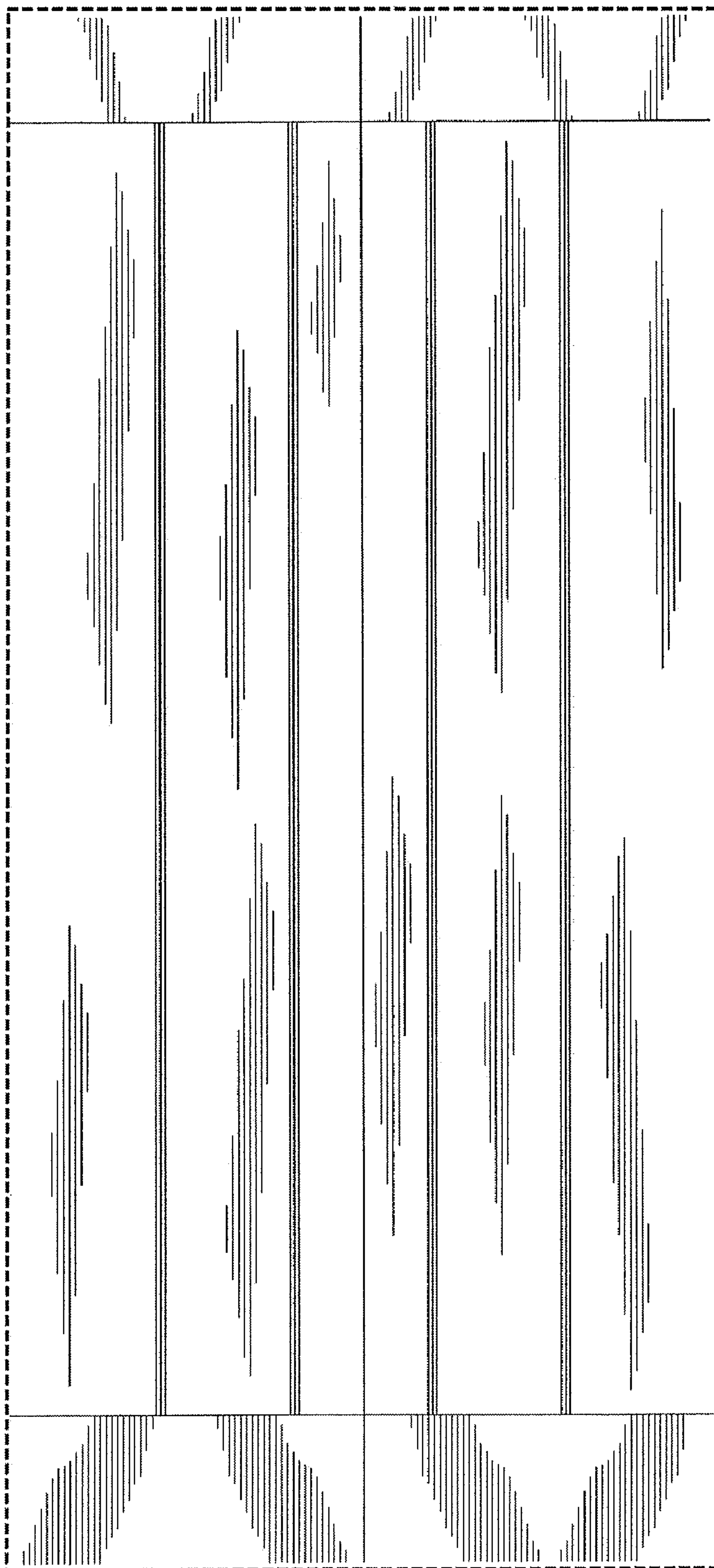

Fig. 133

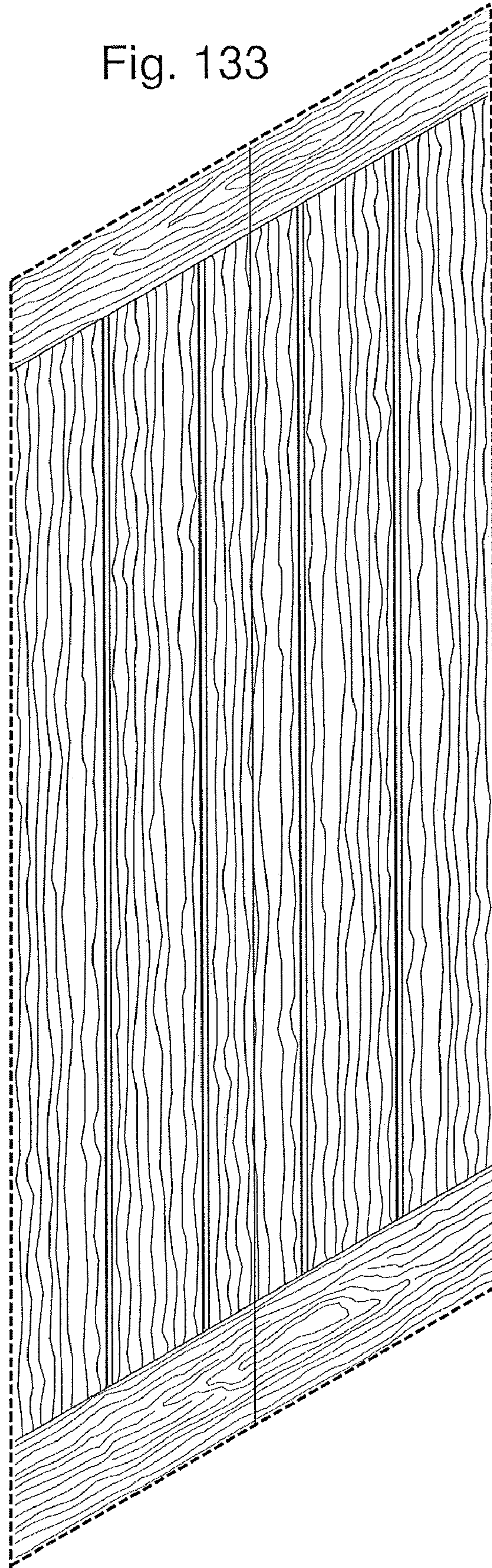

Fig. 134

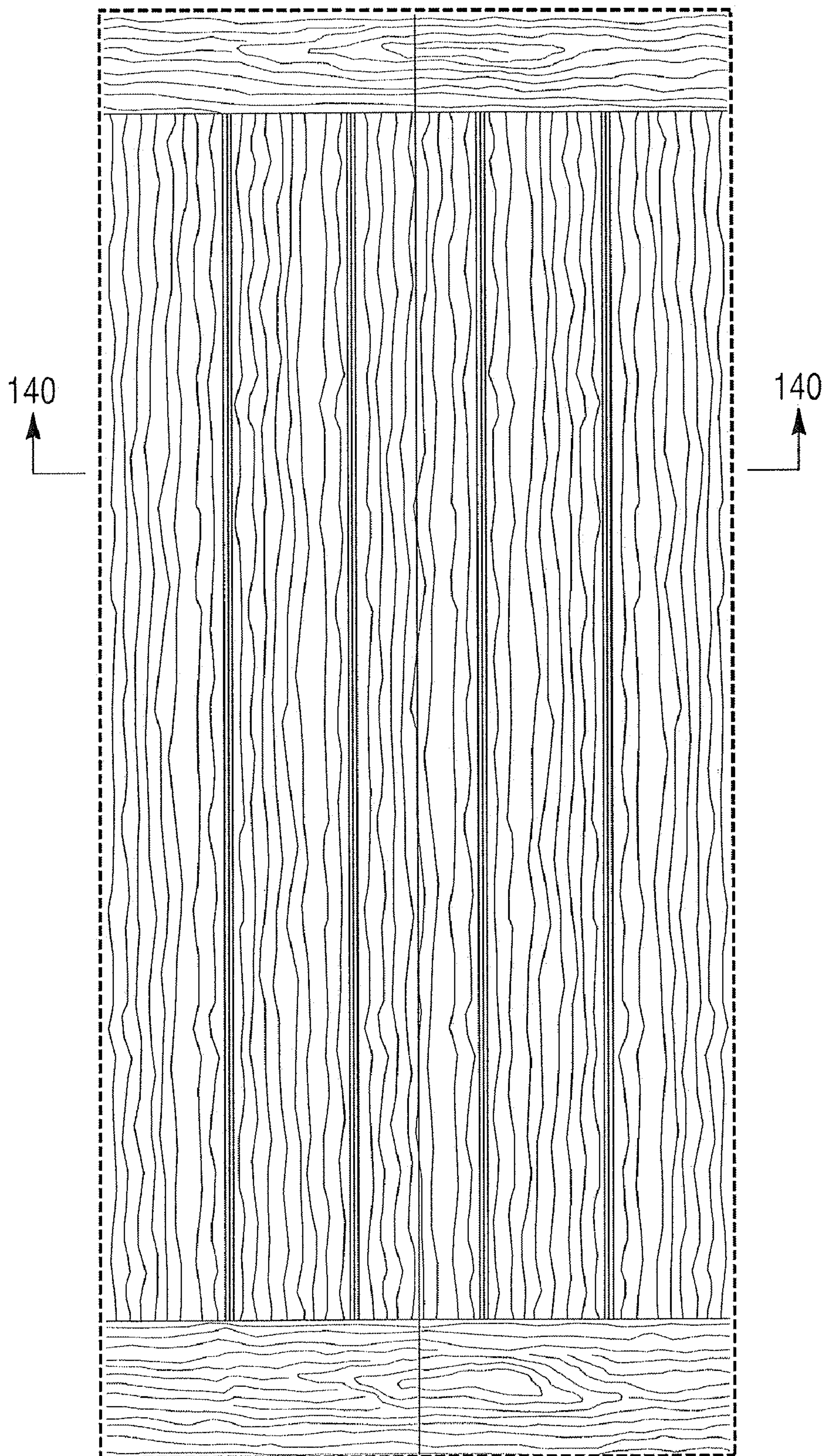

Fig. 135

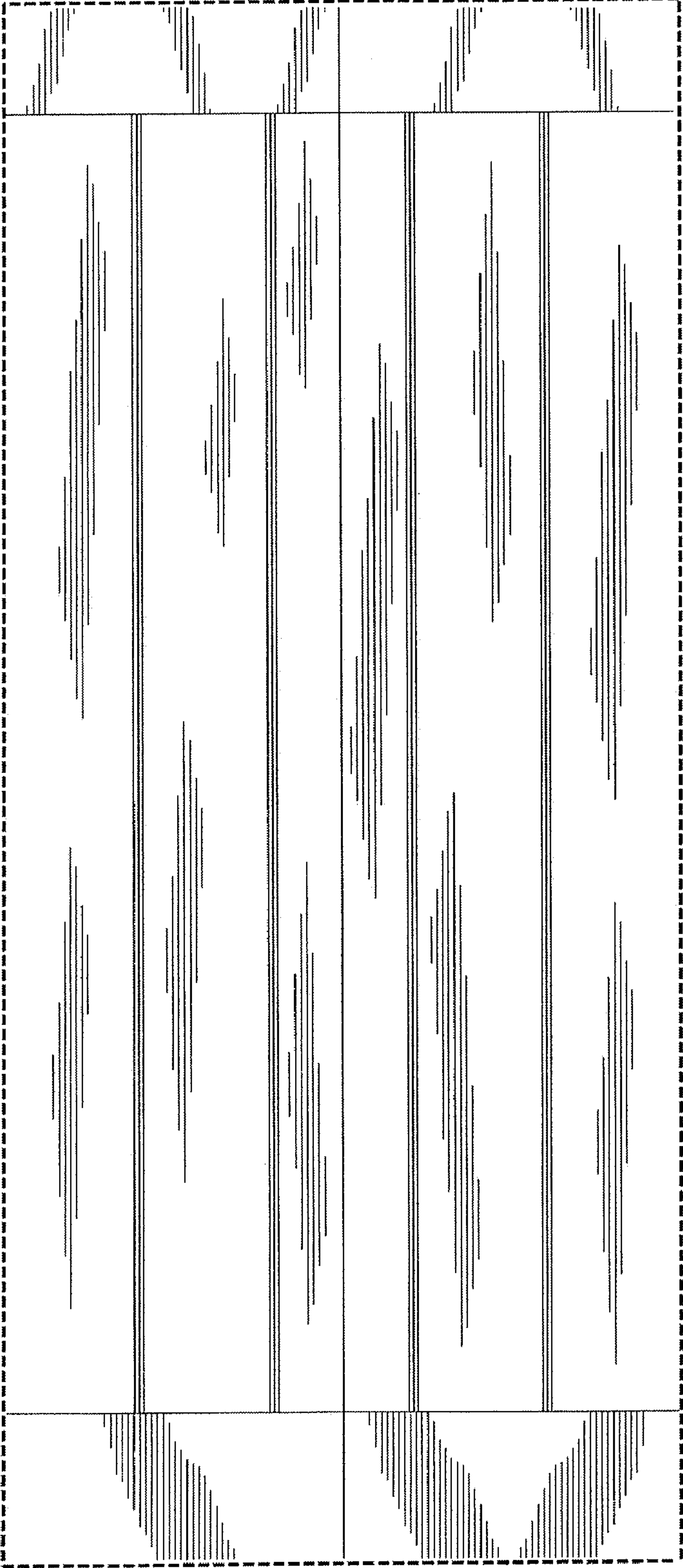

Fig. 136



Fig. 137



Fig. 138

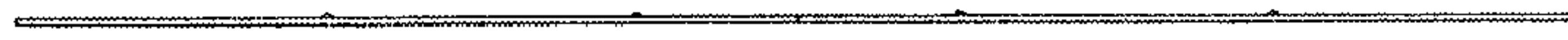

Fig. 139

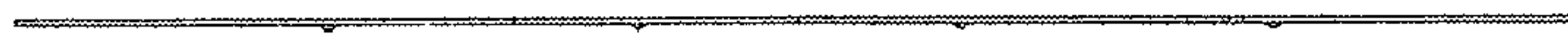

Fig. 140

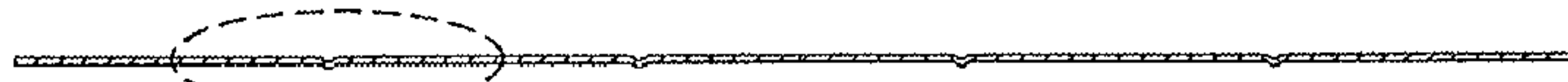

Fig. 141

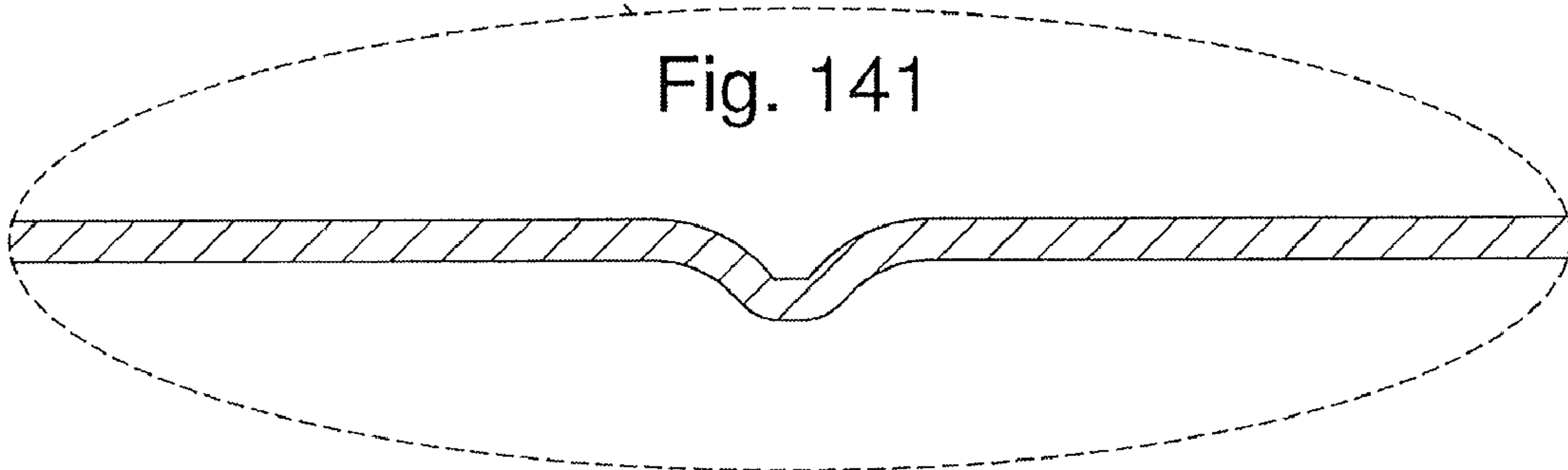

Fig. 142

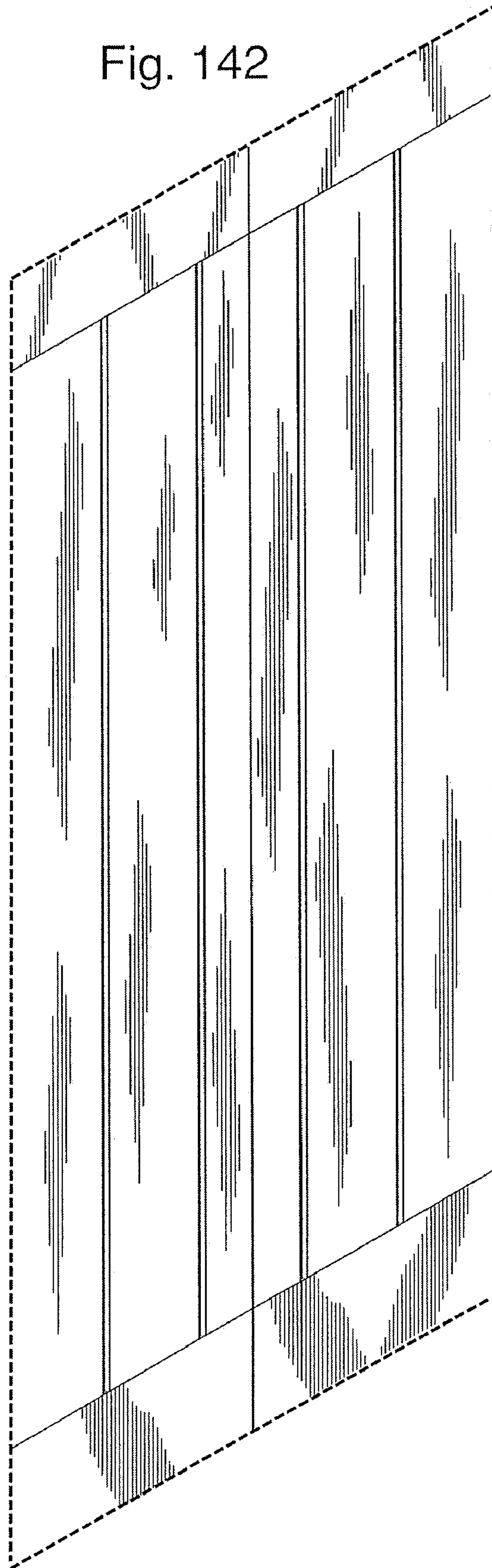

Fig. 143

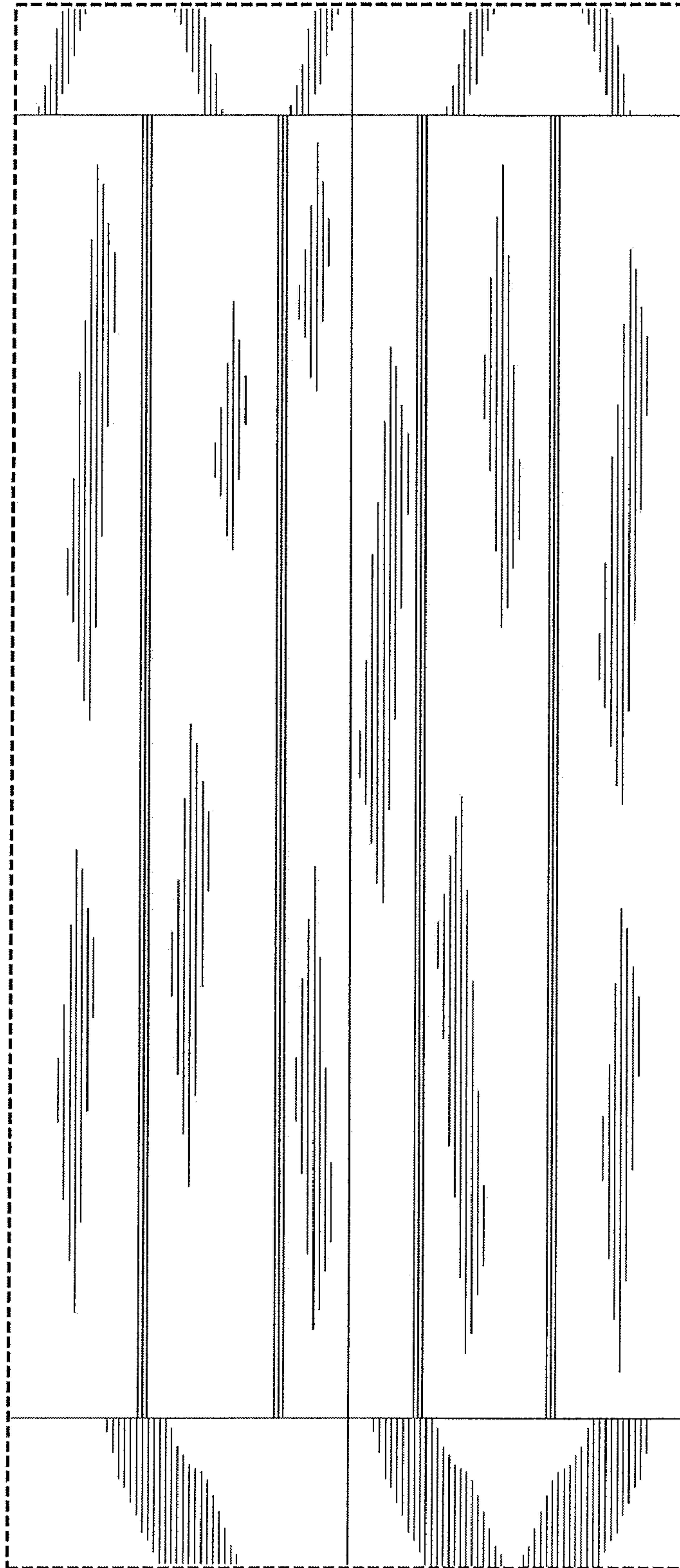

Fig. 144

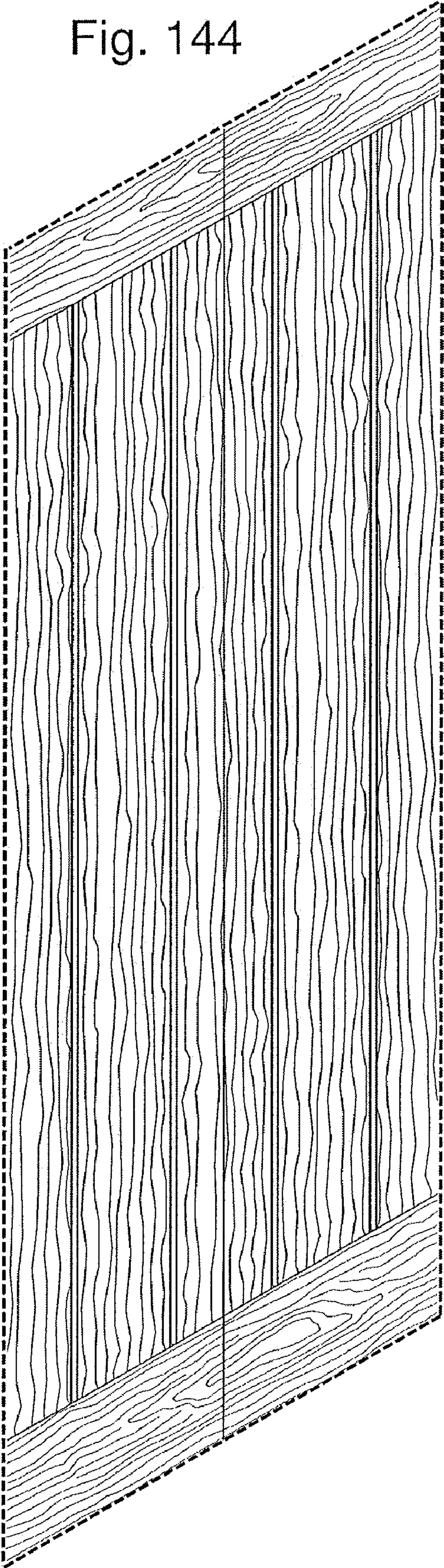

Fig. 145

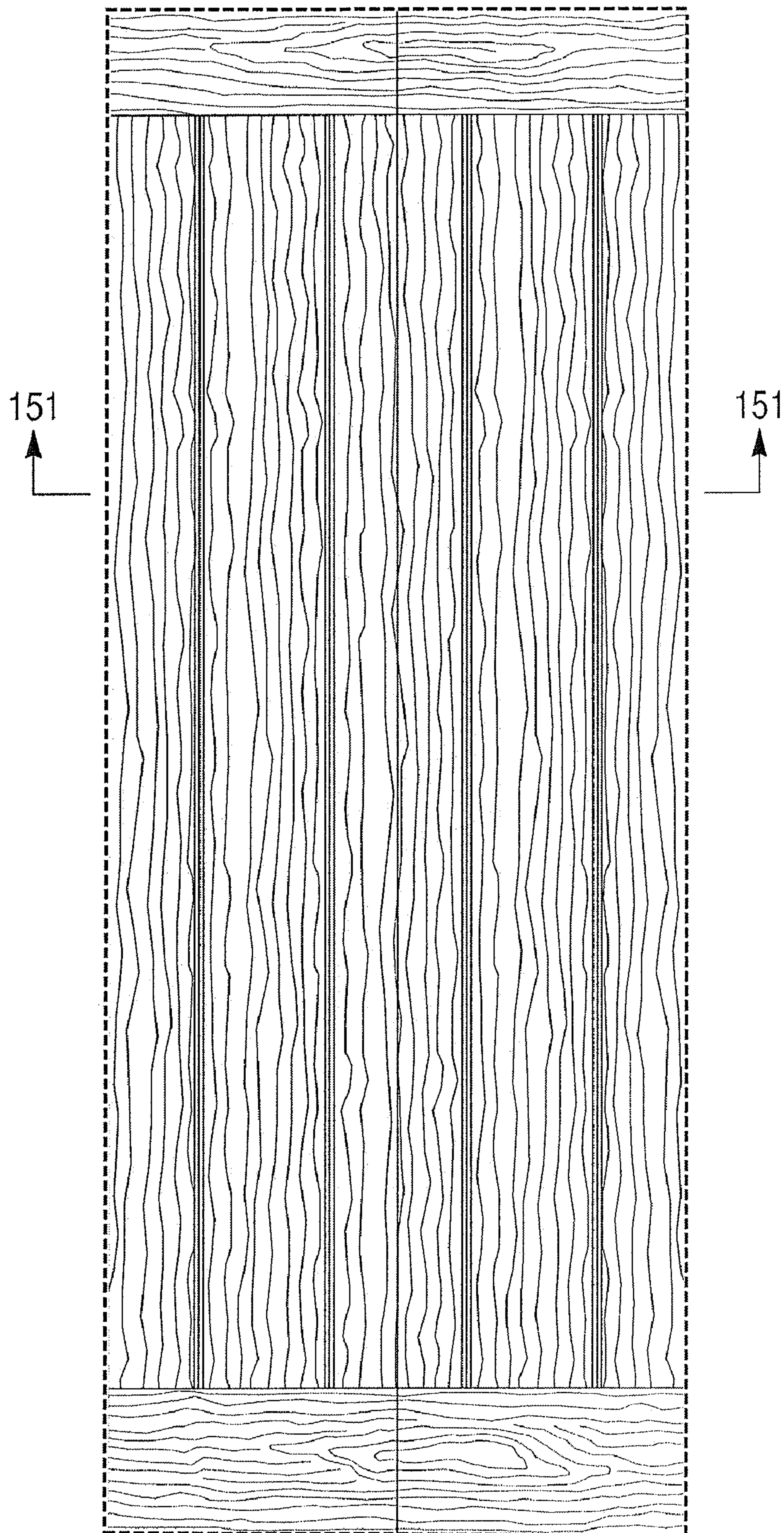

Fig. 146

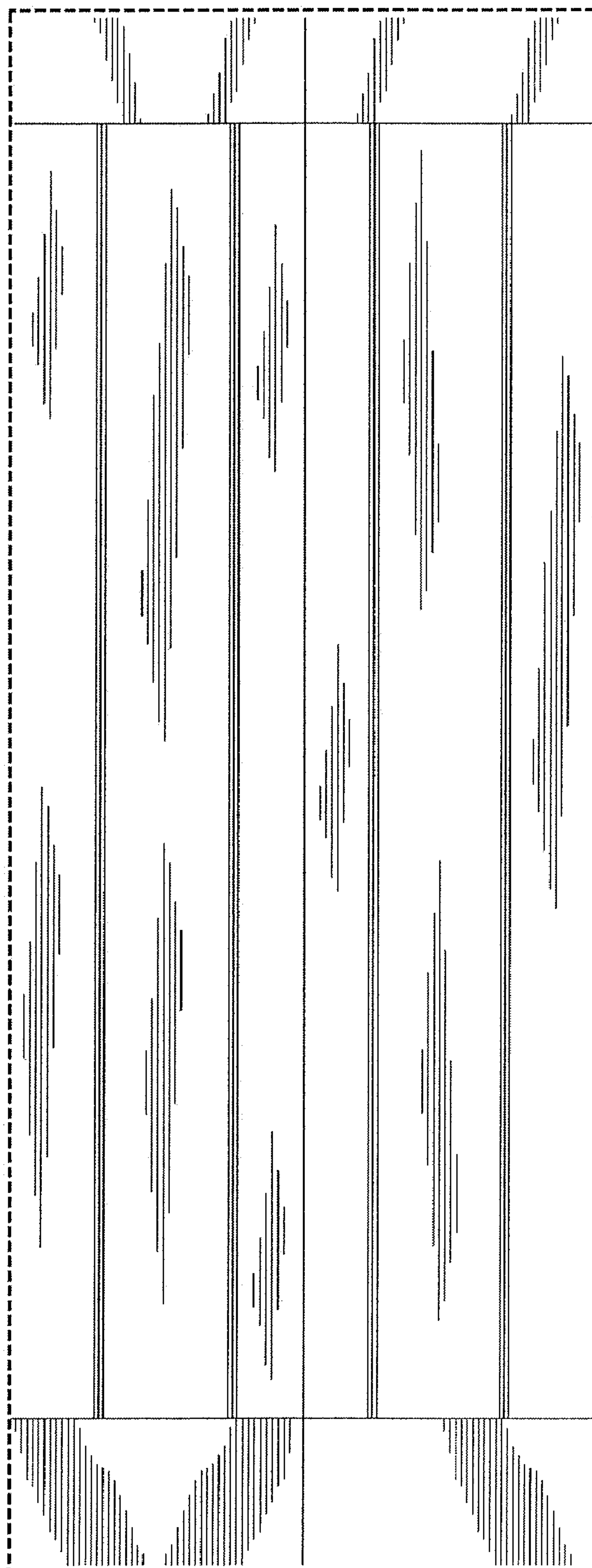

Fig. 147



Fig. 148

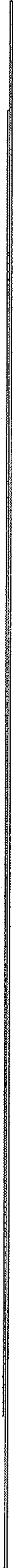

Fig. 149

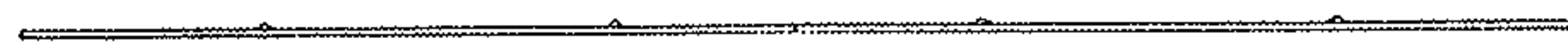

Fig. 150



Fig. 151

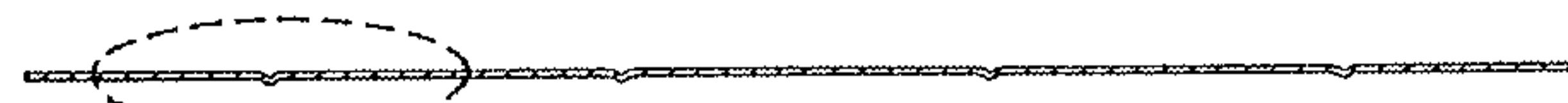

Fig. 152

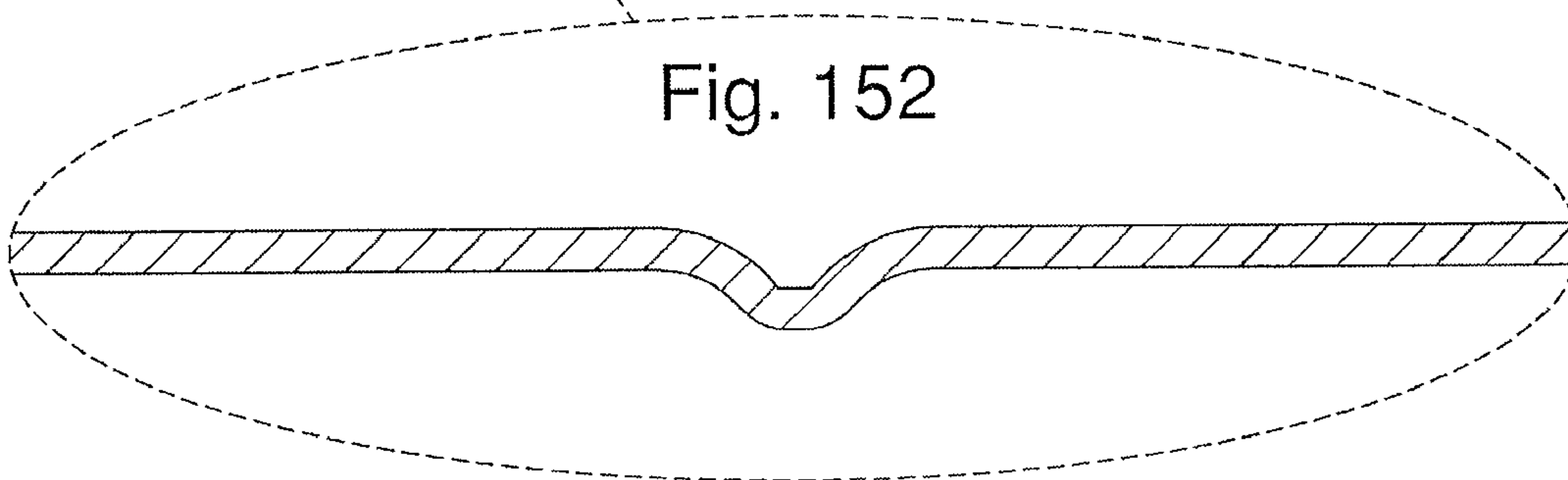

Fig. 153

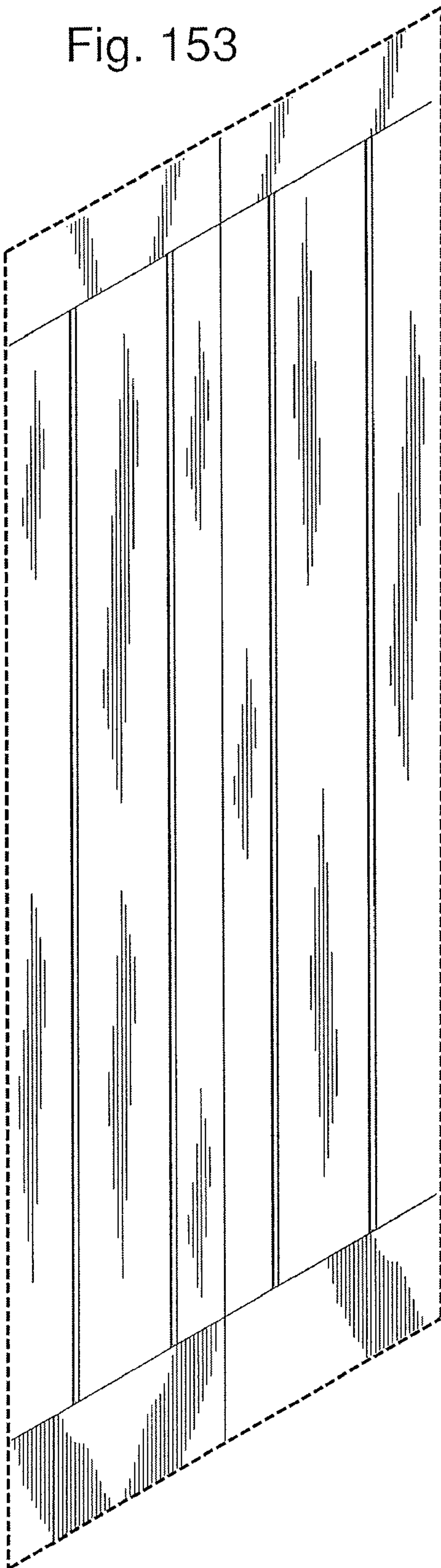

Fig. 154

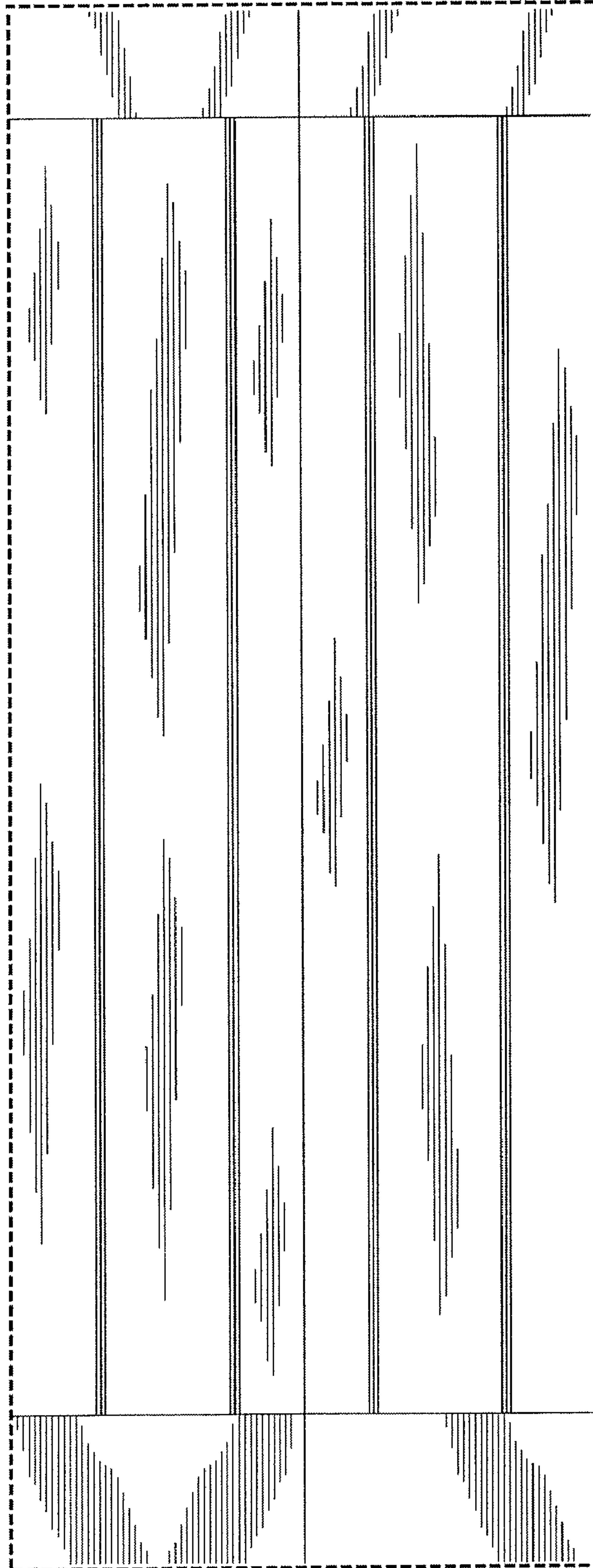

Fig. 155

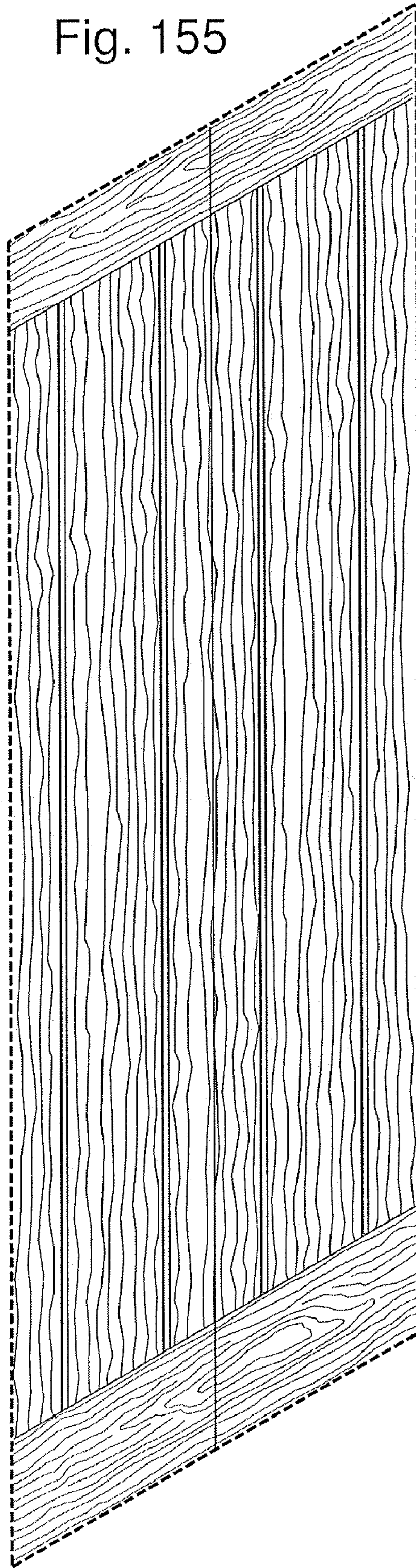

Fig. 156

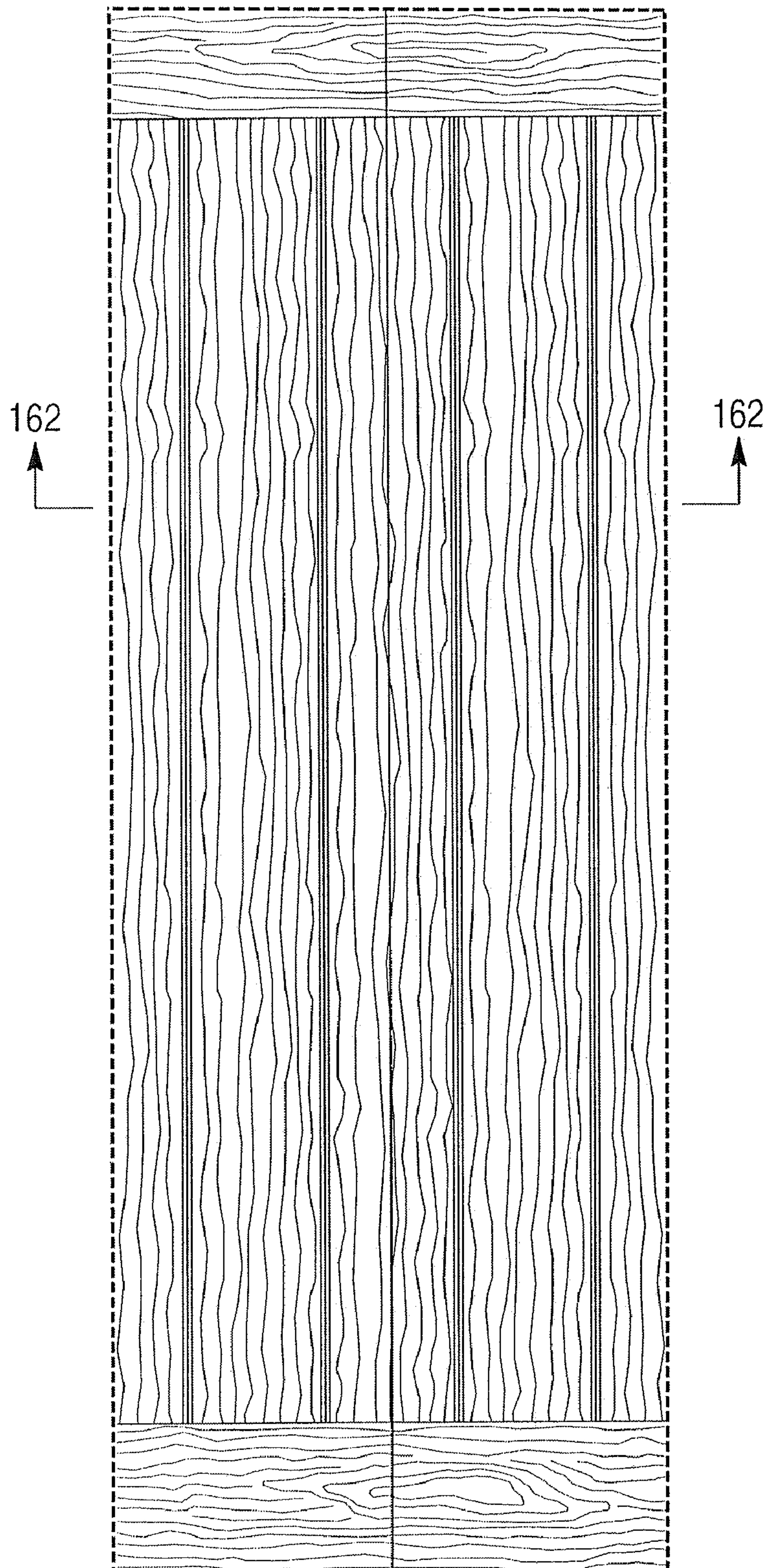

Fig. 157

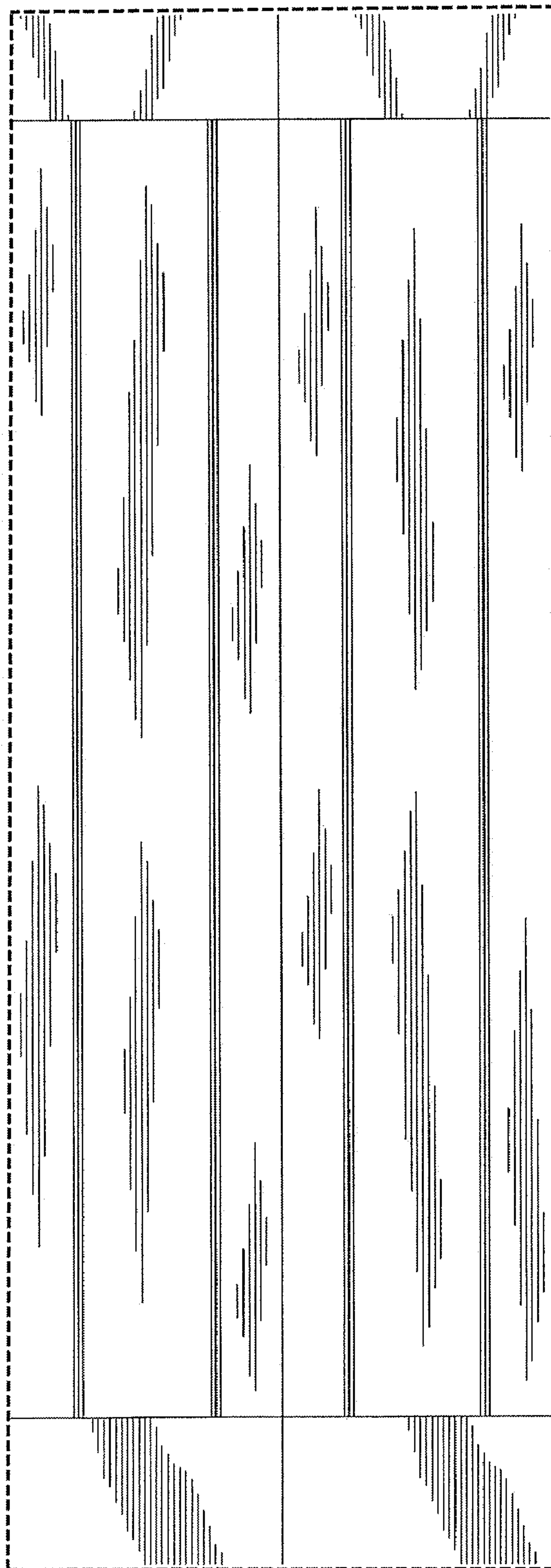

Fig. 158



Fig. 159



Fig. 160

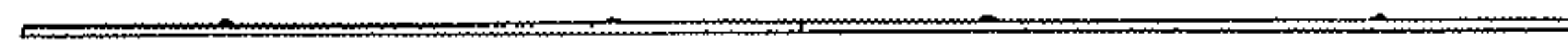

Fig. 161

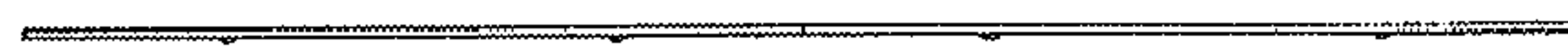

Fig. 162

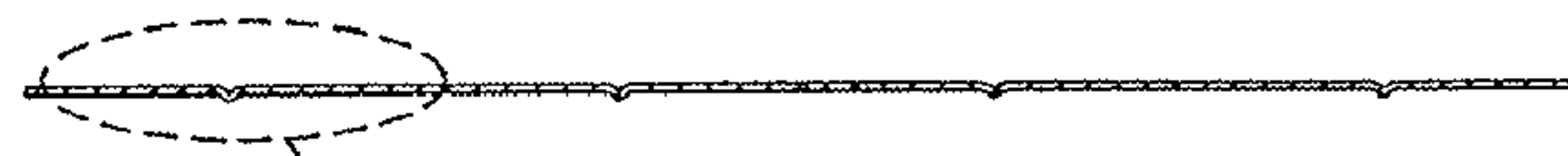

Fig. 163

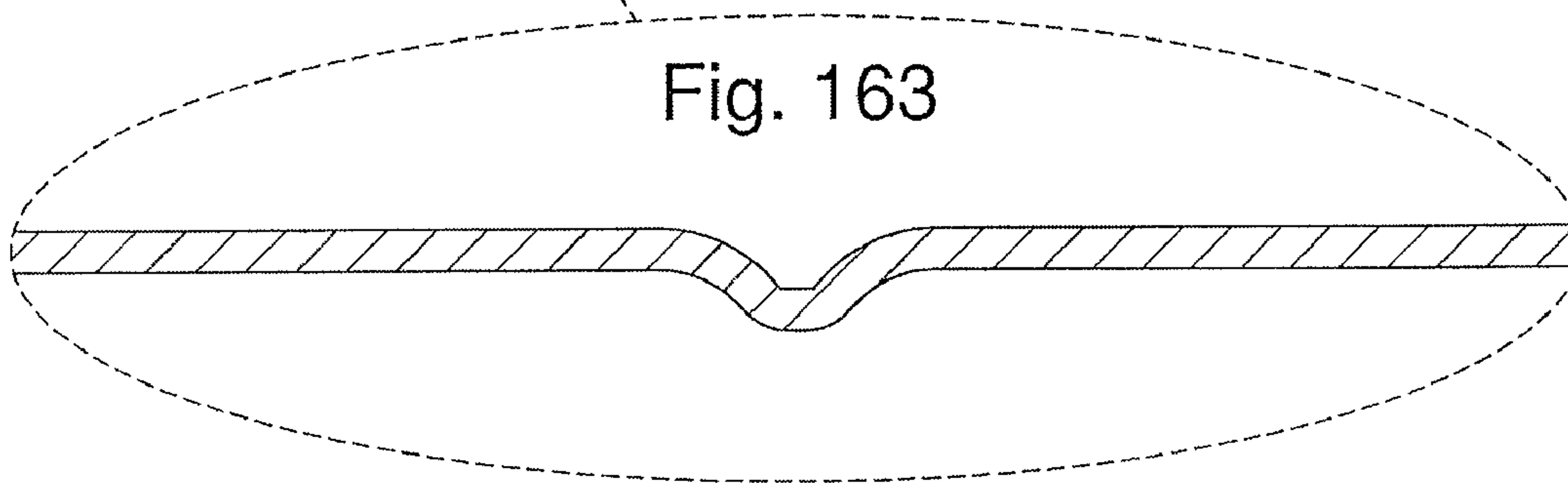

Fig. 164

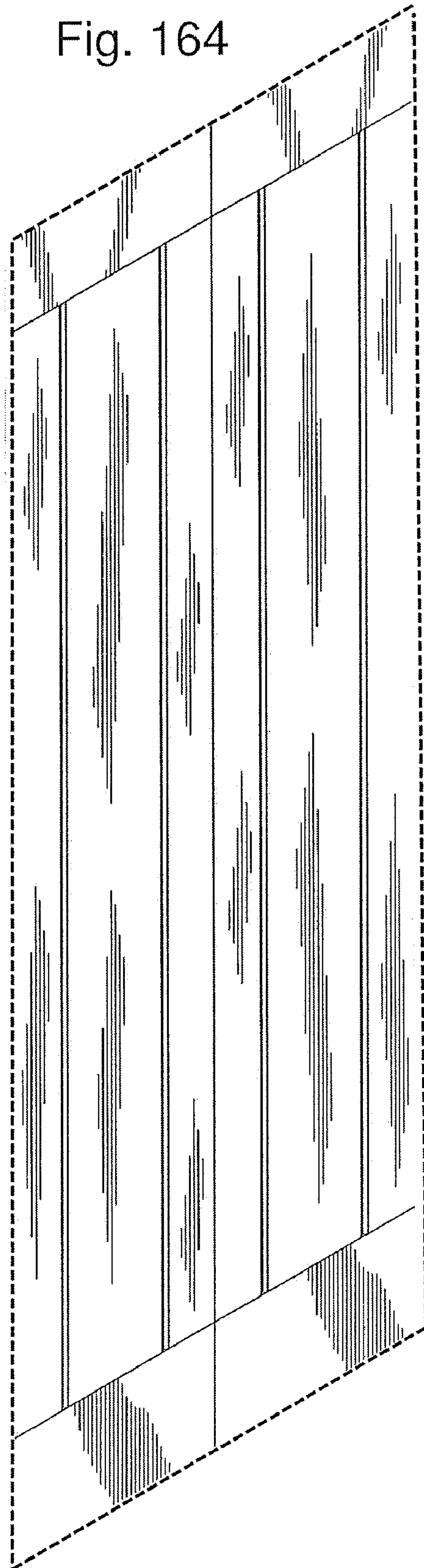

Fig. 165

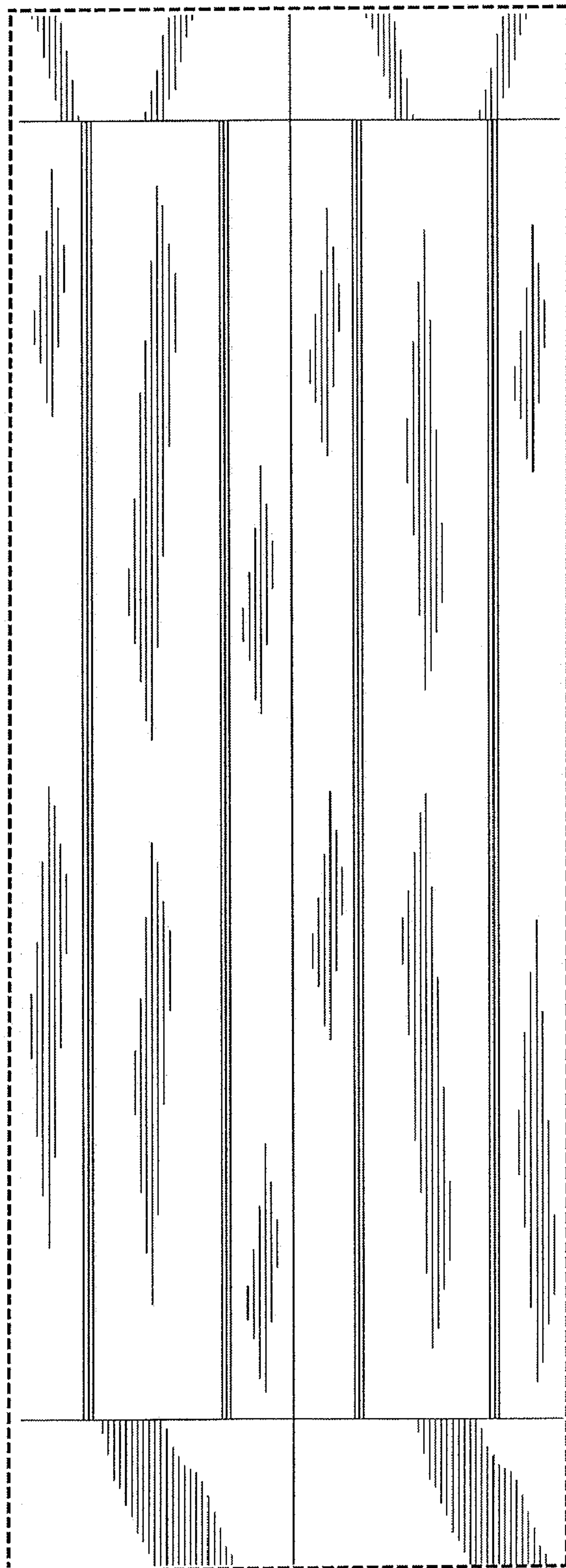

Fig. 166

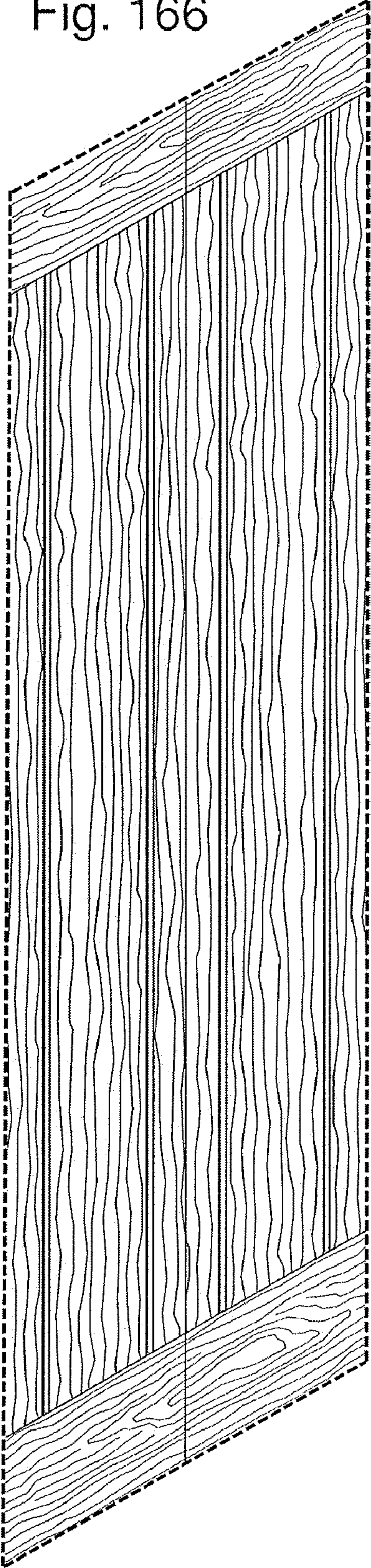

Fig. 167

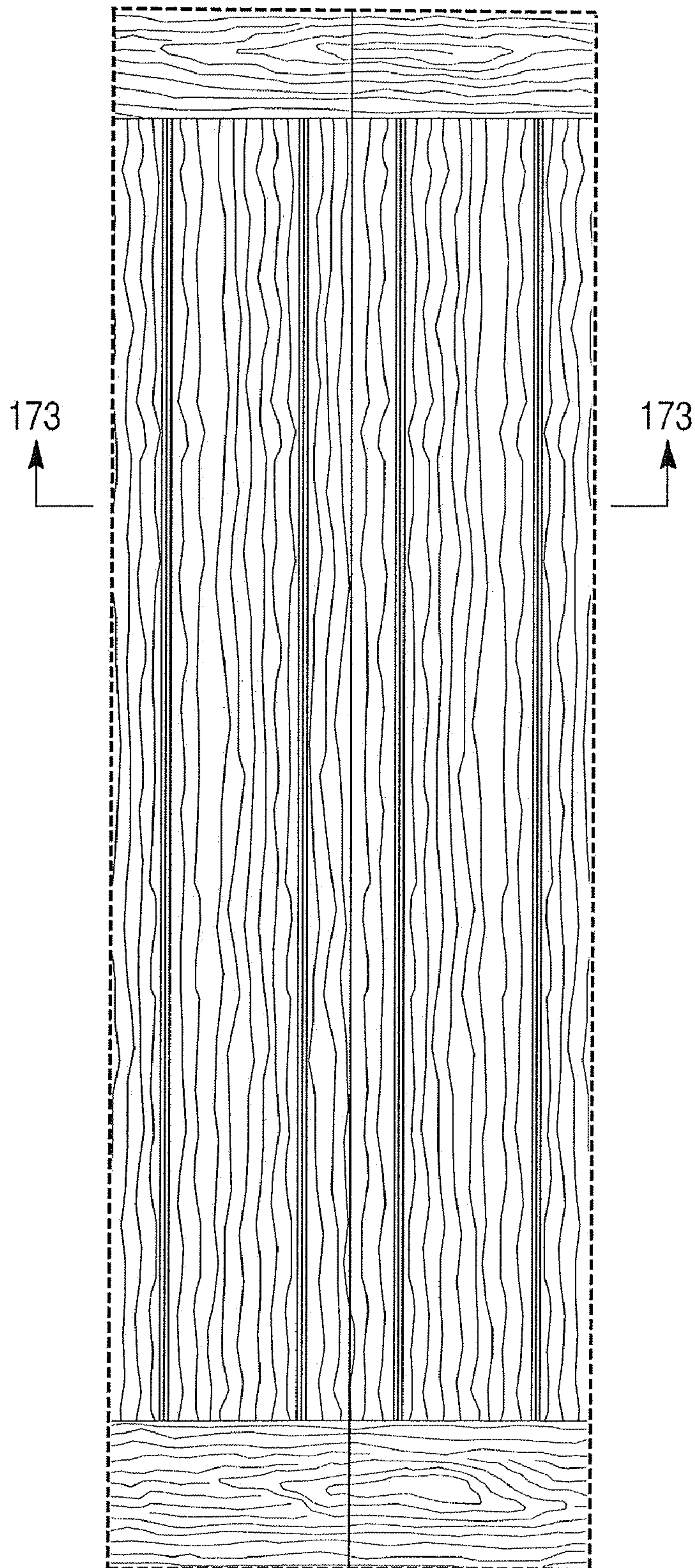

Fig. 168

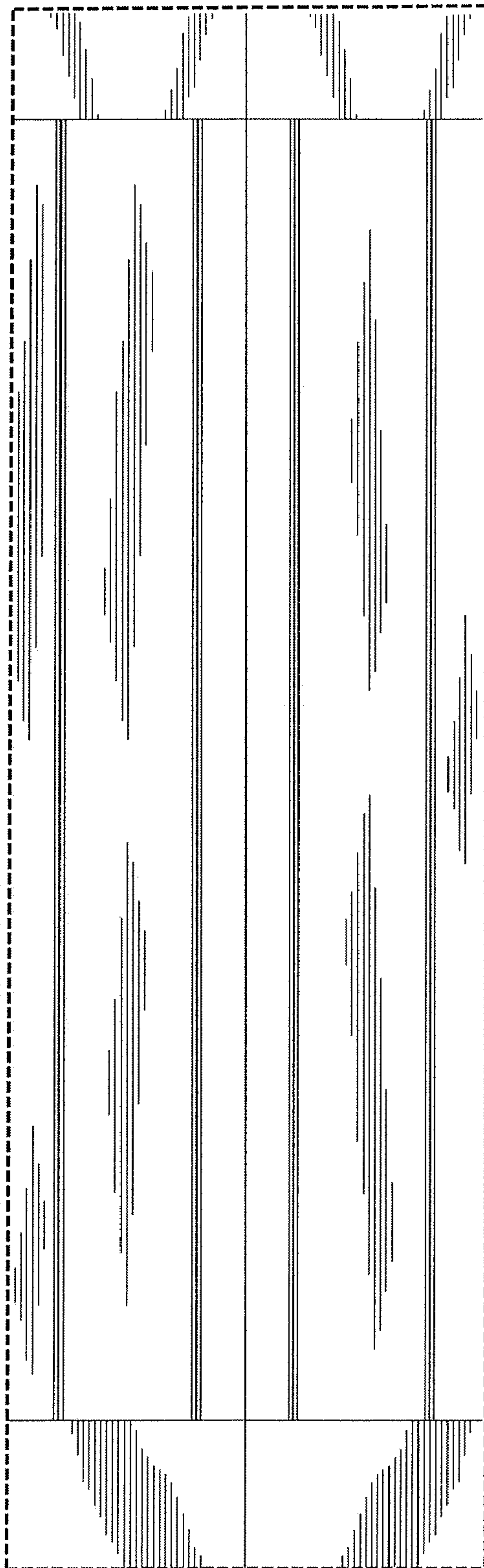

Fig. 169



Fig. 170



Fig. 171

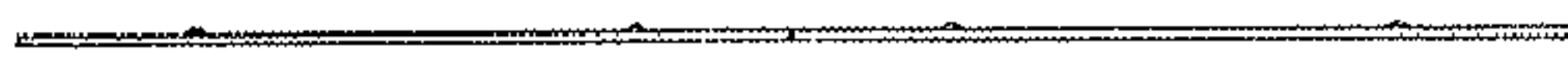

Fig. 172

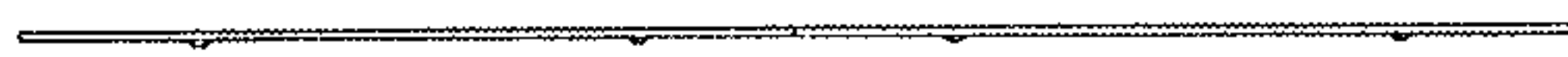

Fig. 173

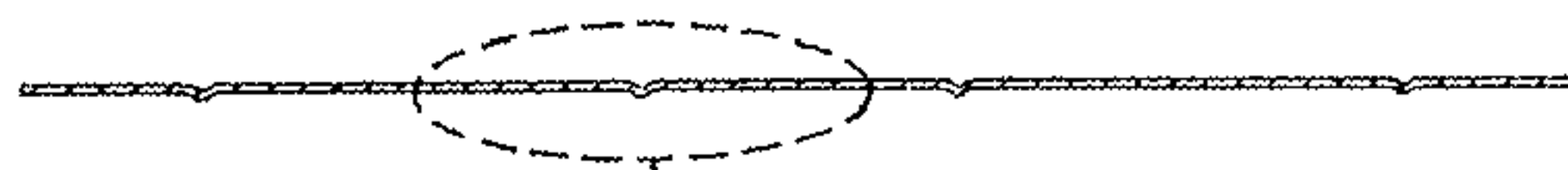

Fig. 174

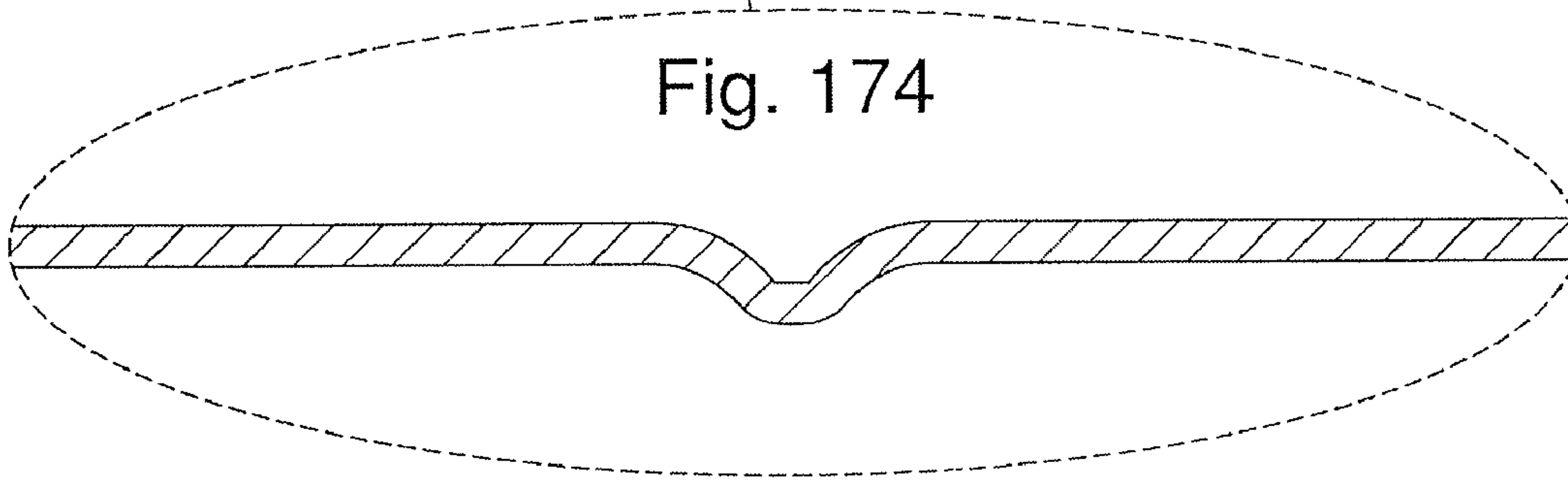

Fig. 175

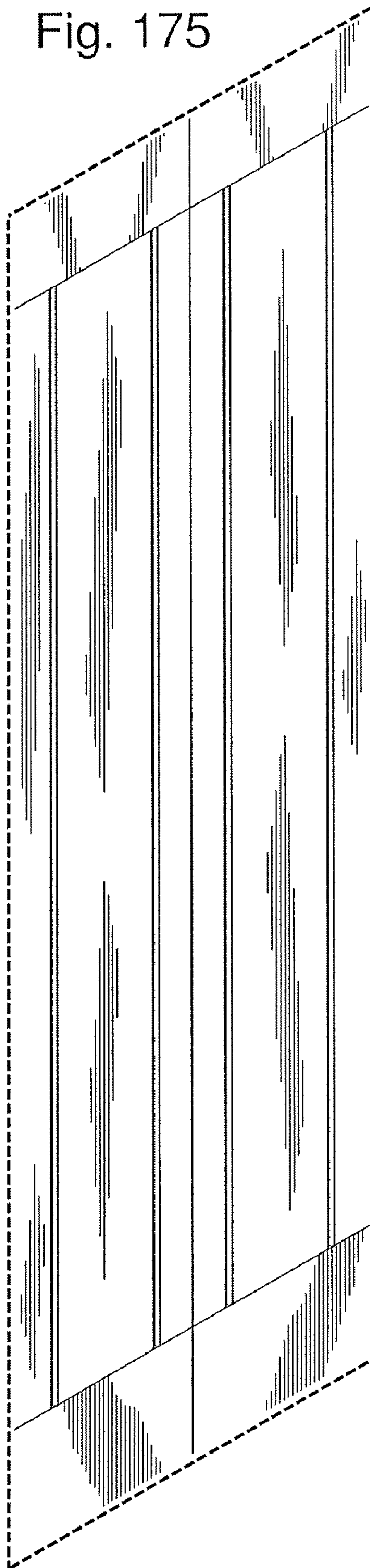

Fig. 176

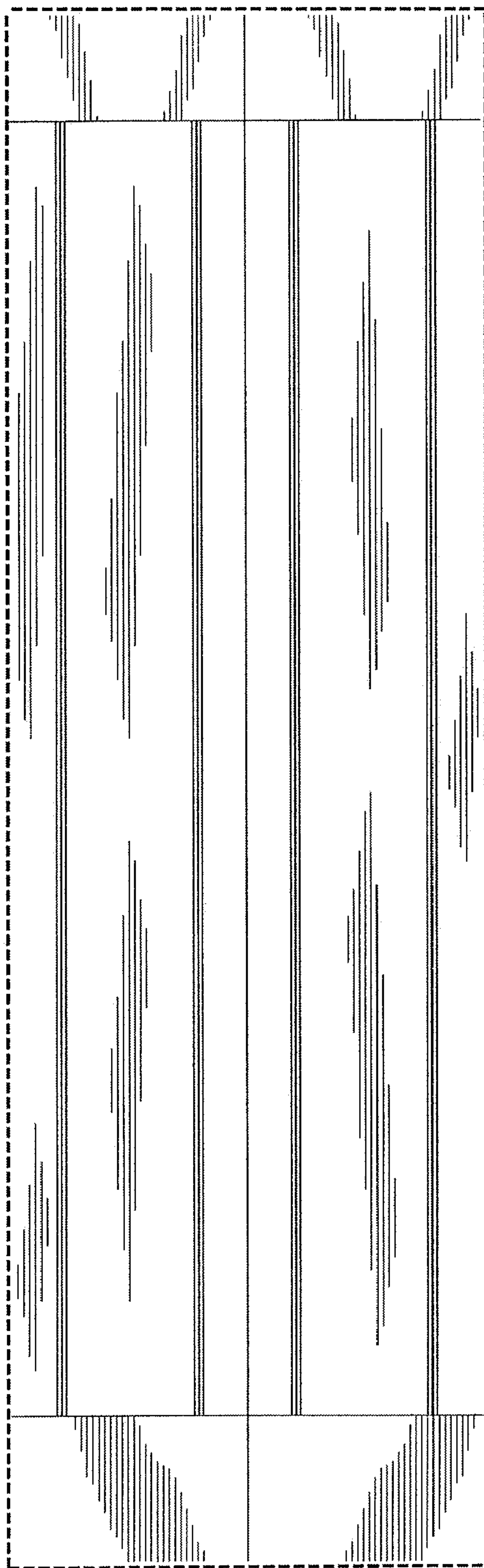

Fig. 177

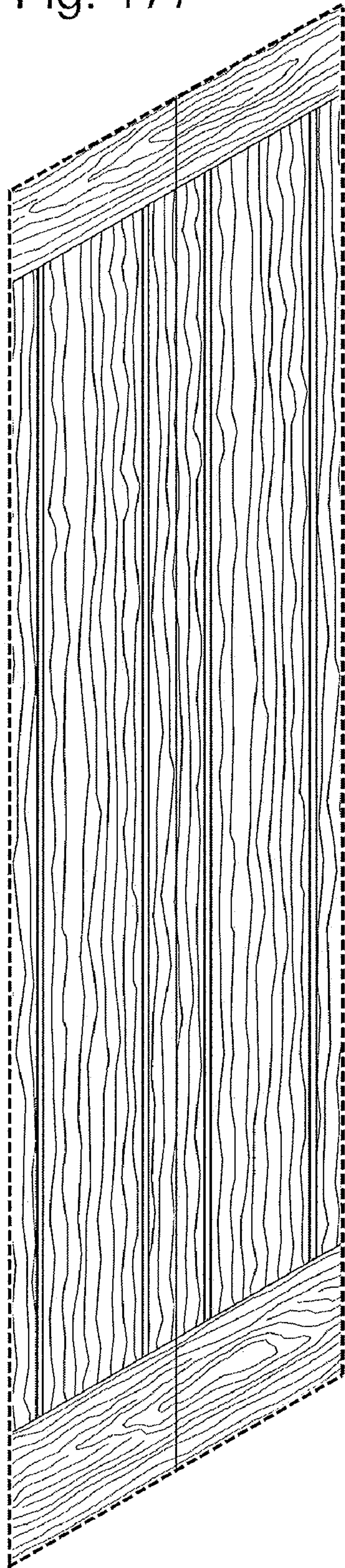

Fig. 178

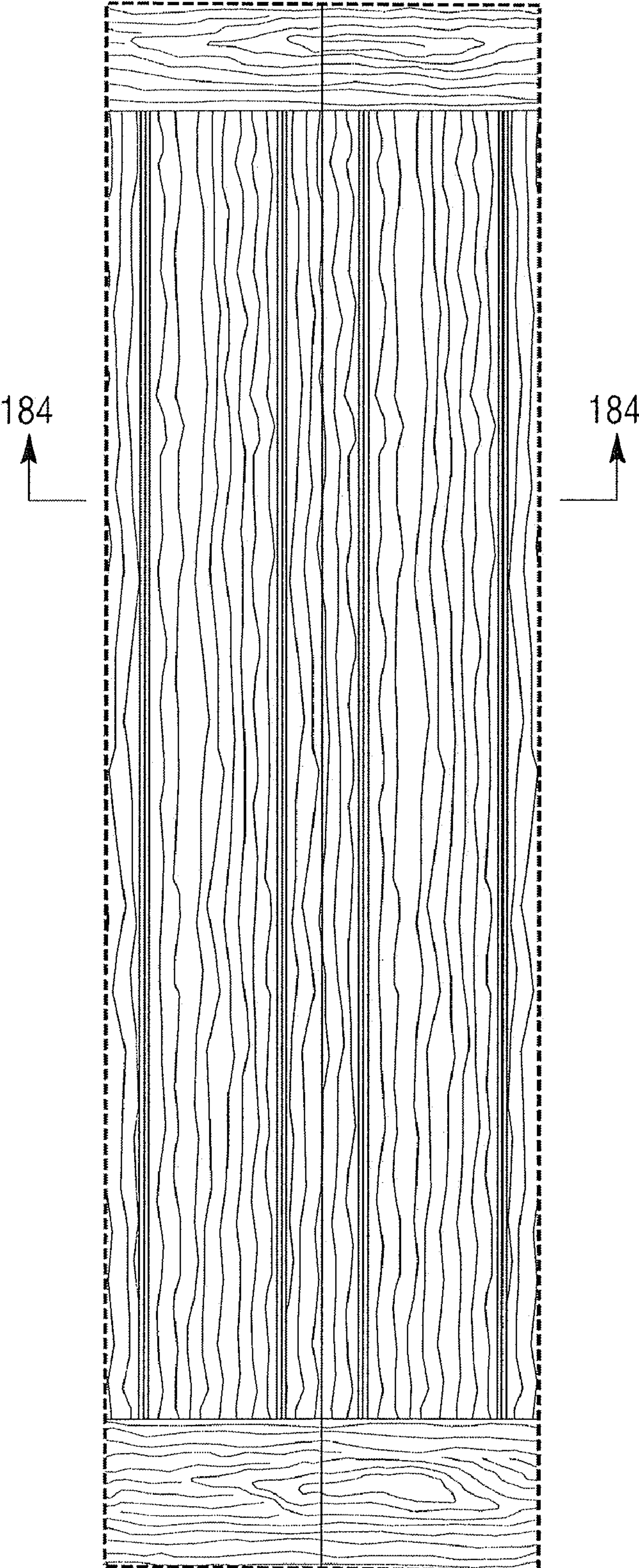

Fig. 179

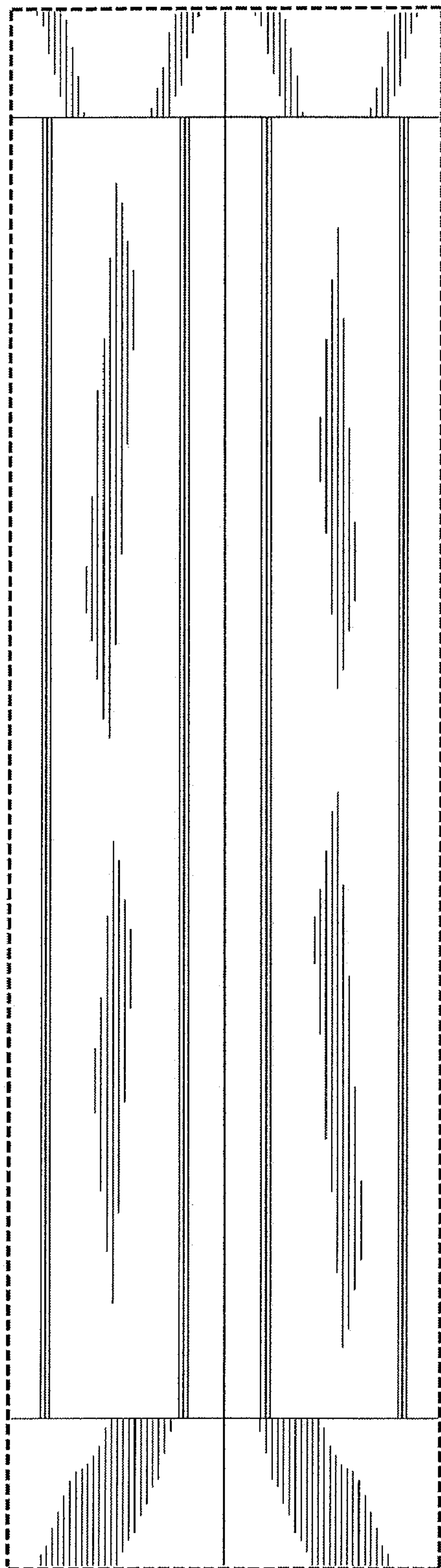

Fig. 180



Fig. 181



Fig. 182

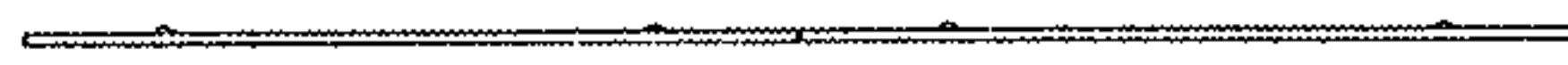

Fig. 183

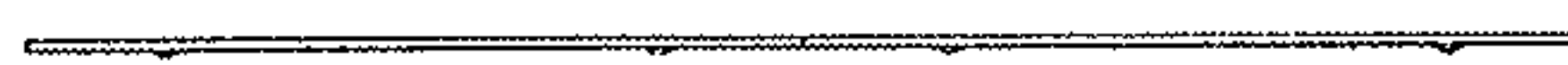

Fig. 184

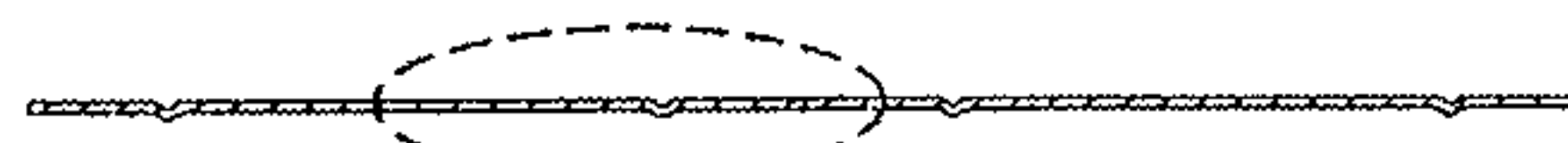

Fig. 185

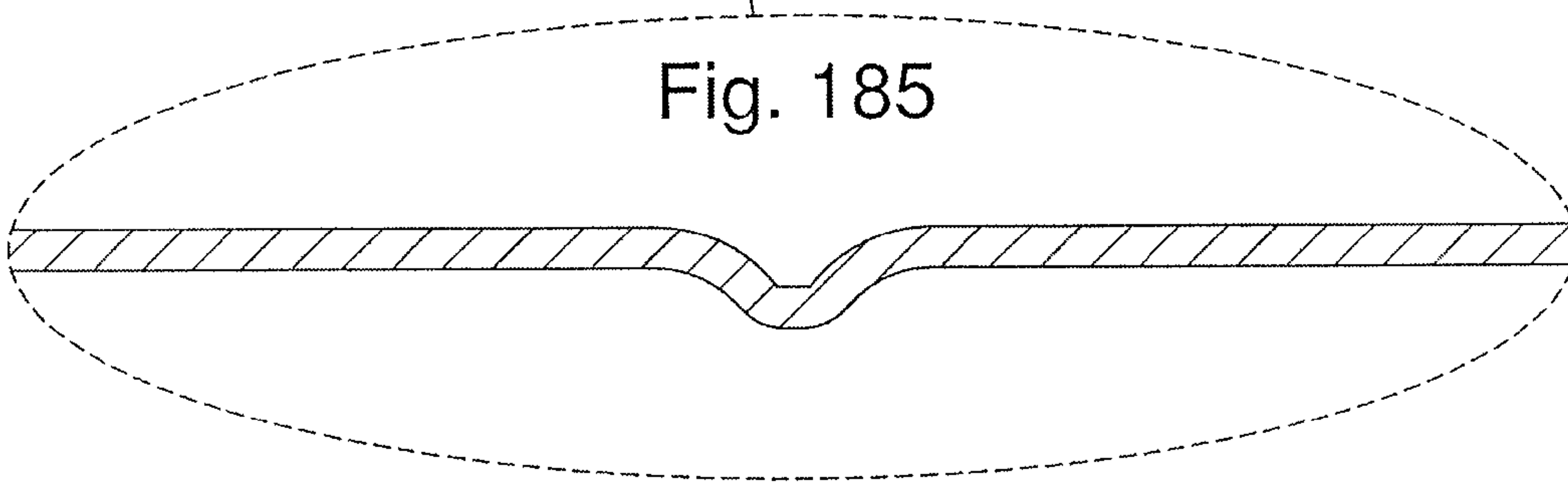

Fig. 186

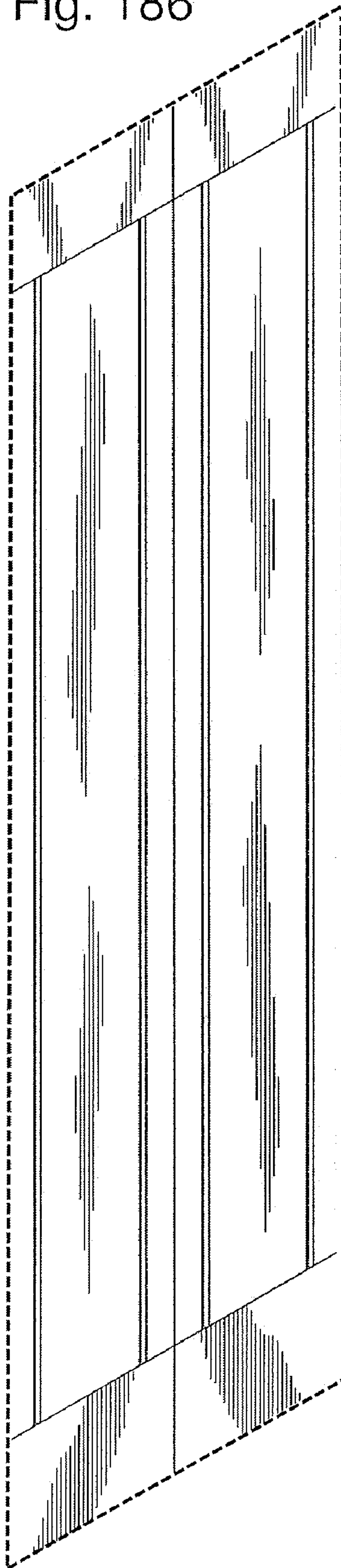

Fig. 187

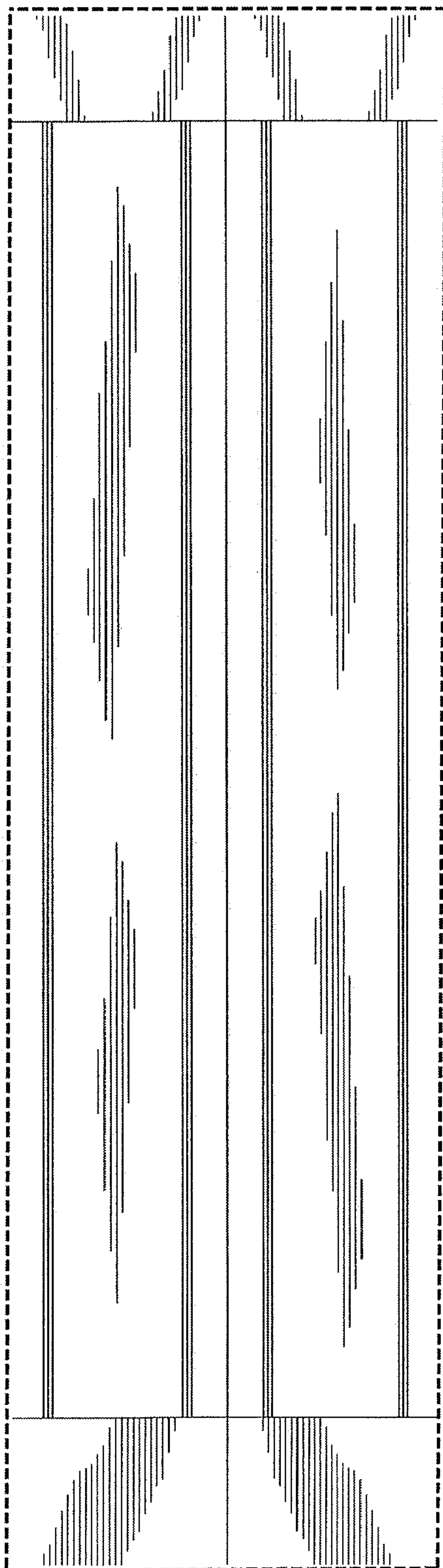

Fig. 188

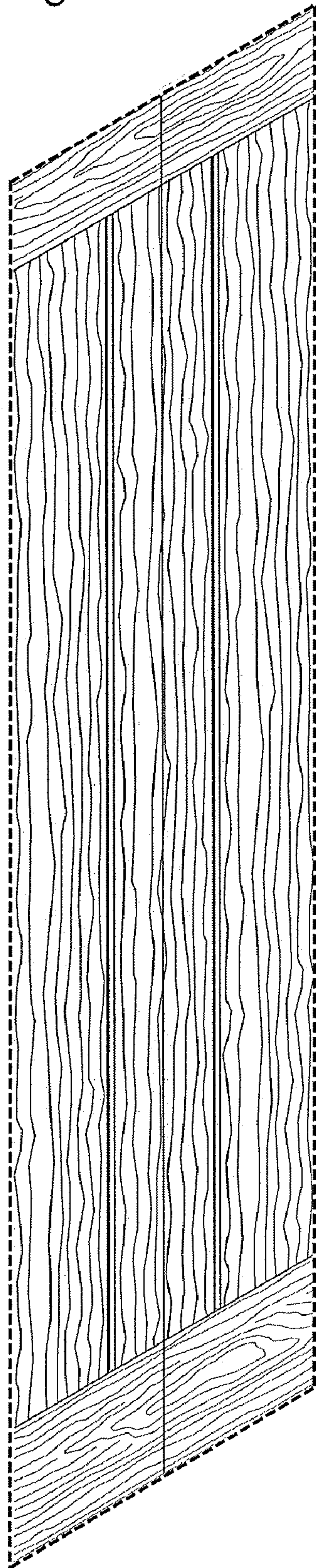

Fig. 189

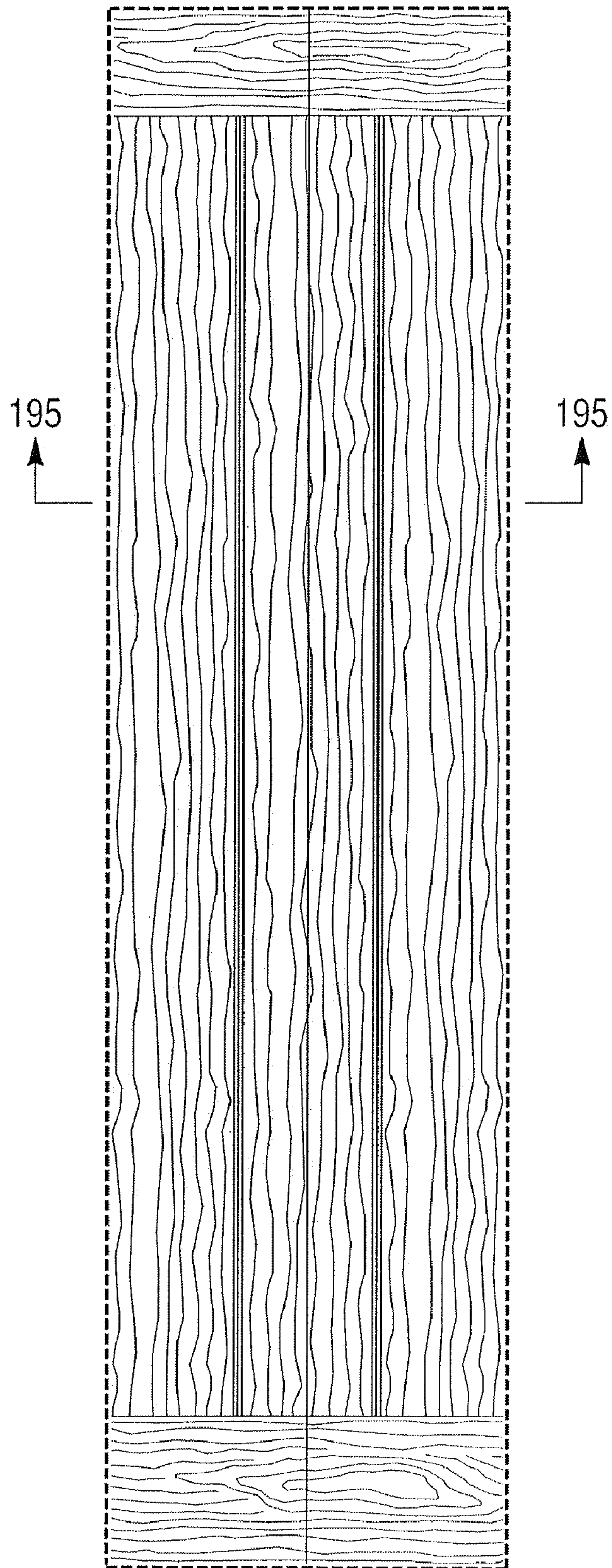

Fig. 190

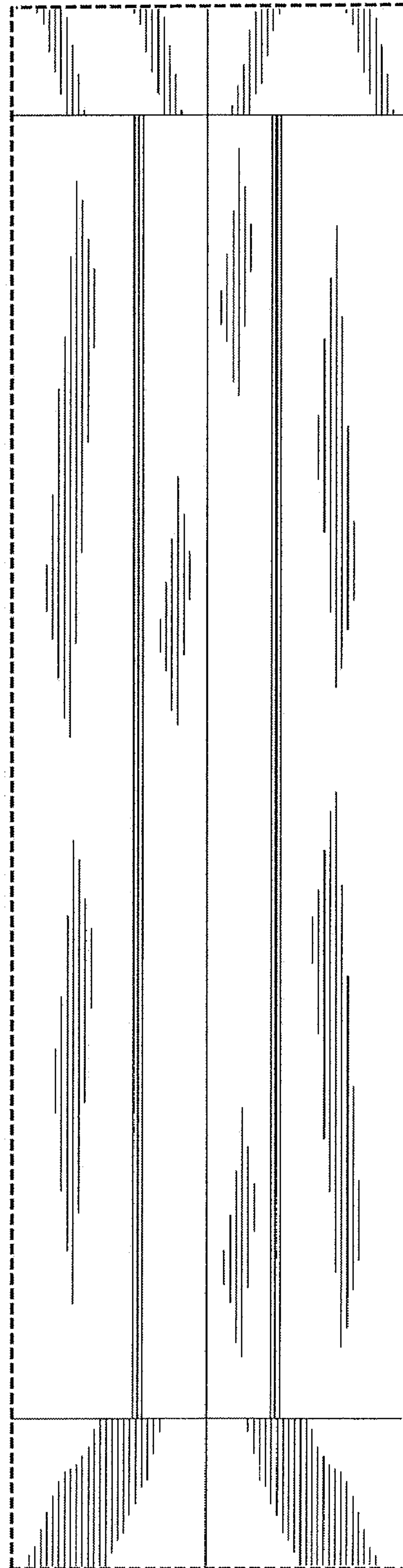

Fig. 191



Fig. 192

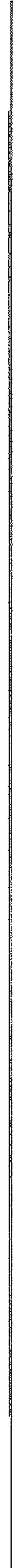

Fig. 193

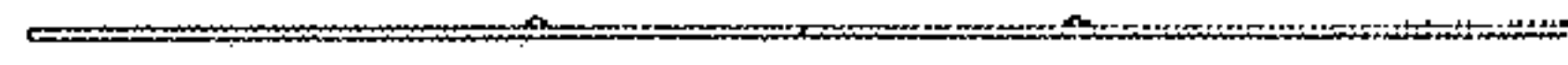

Fig. 194

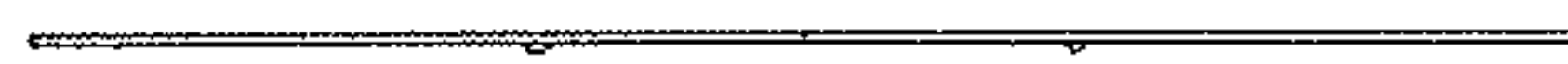

Fig. 195

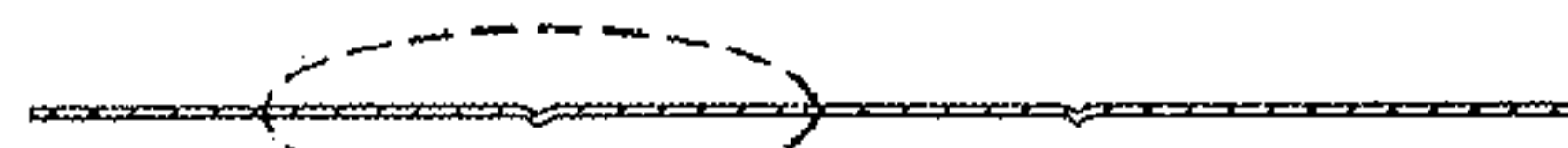

Fig. 196

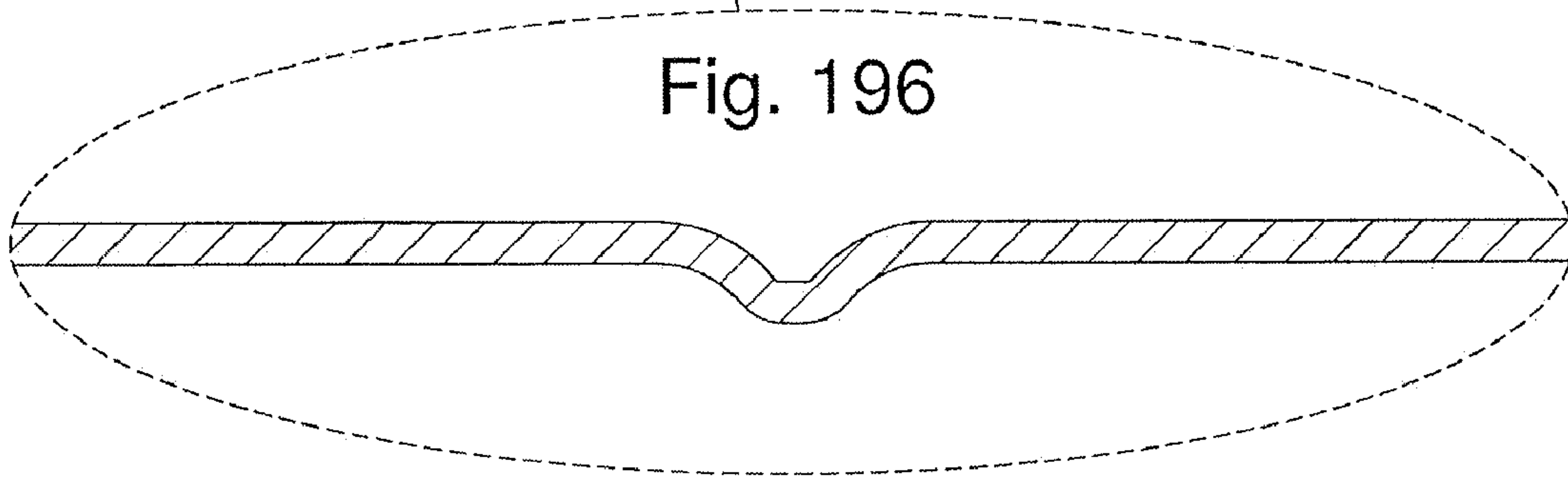

Fig. 197

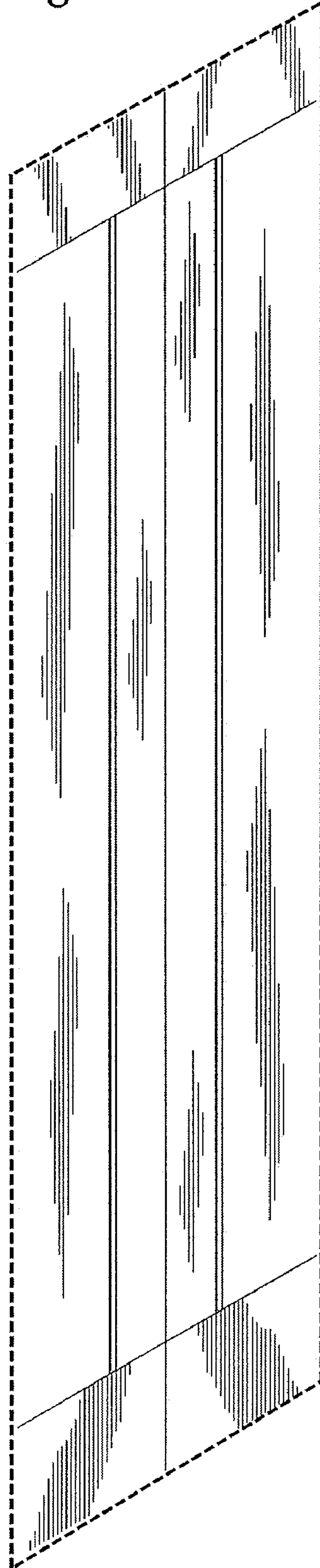

Fig. 198

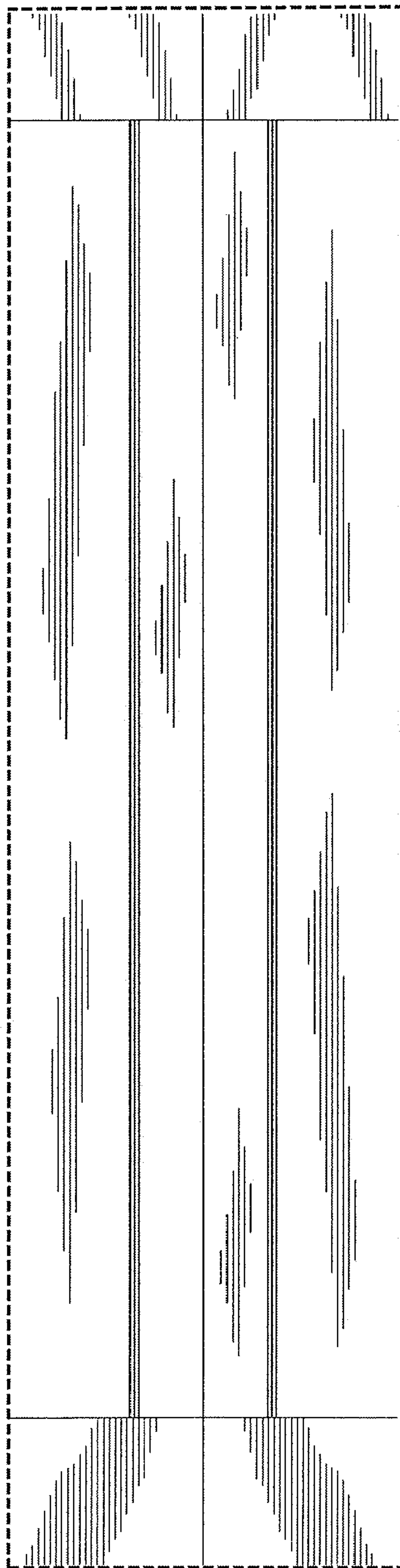

Fig. 199

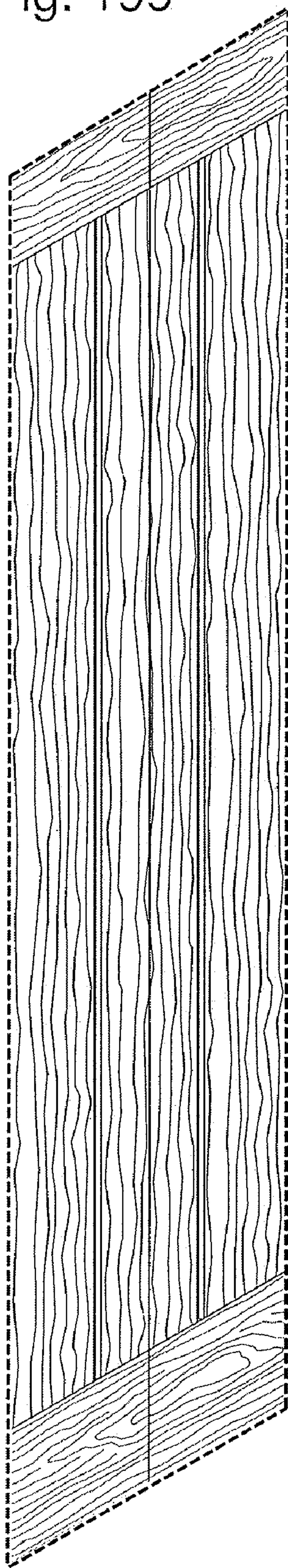

Fig. 200

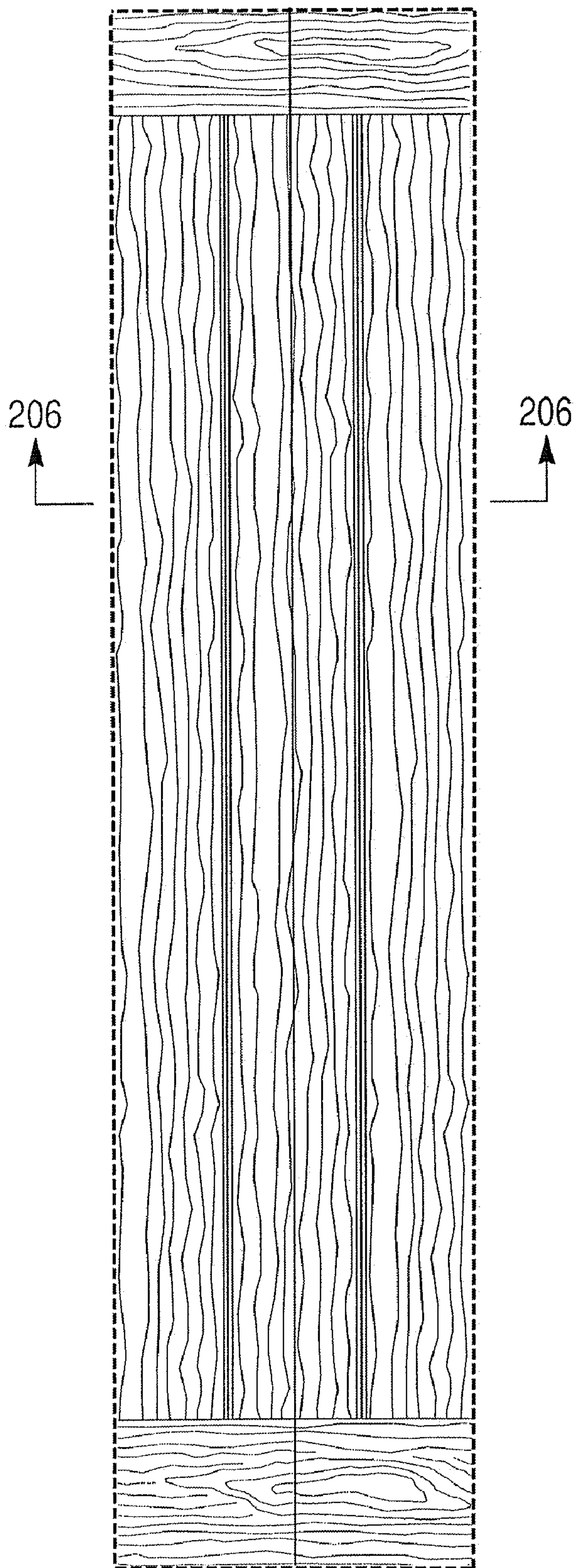

Fig. 201

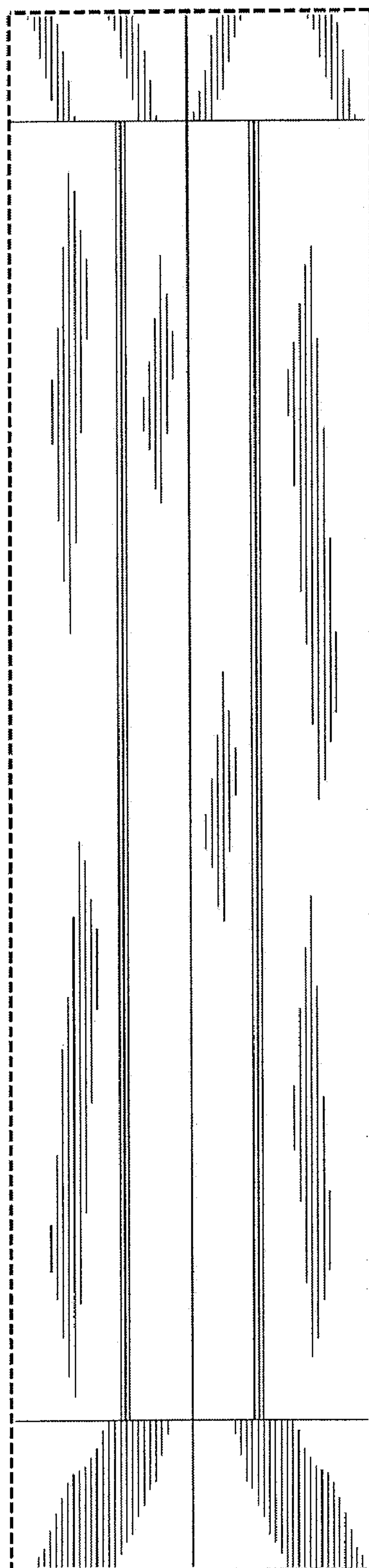

Fig. 202



Fig. 203



Fig. 204

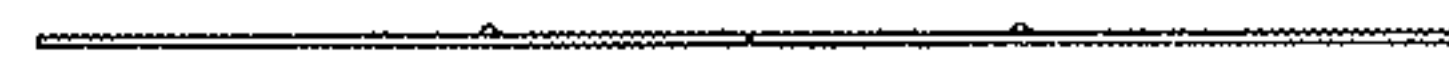

Fig. 205

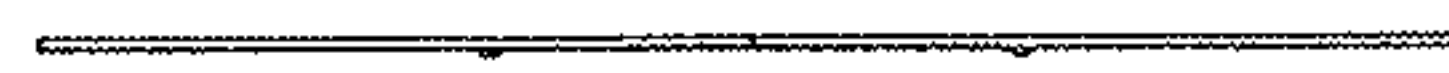

Fig. 206

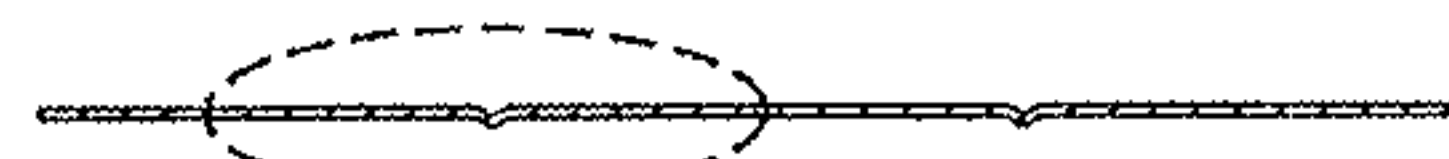

Fig. 207

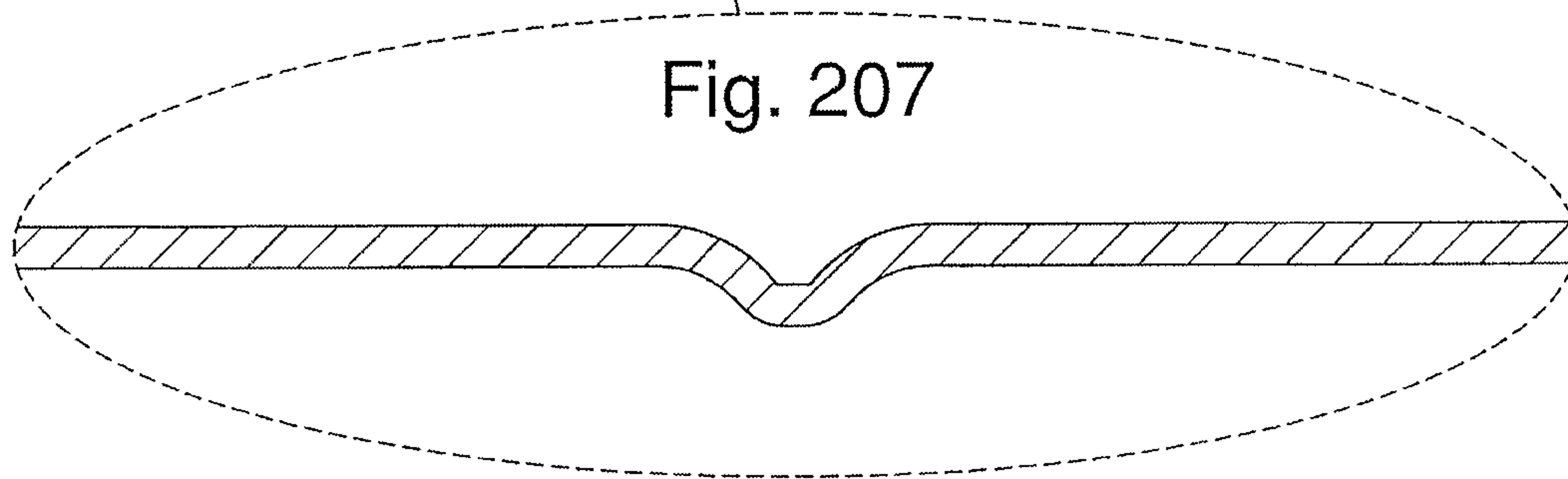

Fig. 208

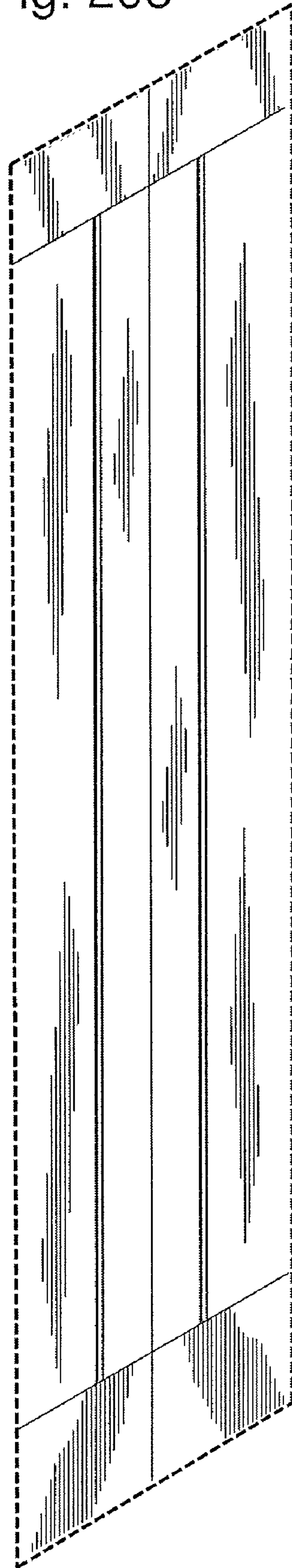

Fig. 209

